



Building industry expertise since 1889

---

**BUILDERS**  
METALWORK



## Welcome to this latest guide from Expamet – the brand you can always rely on

Expamet products are developed to ensure high levels of performance, ease of use and fast, accurate installation. Our extensive range is designed to meet the complex demands of individual projects whilst saving time and cost.

Expamet building products are available nationwide via all major builders merchants and distributors. We operate a guaranteed fast ordering process over a nationwide UK network.

### Working outside the UK?

No problem. We have a strong presence across Europe and the Middle East. For your nearest supplier, just call us on +44 (0)191 411 2244 or Email us at [expamet.sales@birtleygroup.co.uk](mailto:expamet.sales@birtleygroup.co.uk)

### Need technical advice?

Call our expert team on 0330 404 9955 and they'll be pleased to help.



## Birtley Group

STRENGTH THROUGH QUALITY



The famous Birtley, Expamet and Bowater brands are now working together within Birtley Group. A combined strength which is adding value to projects across the UK through quality, innovation and higher service levels than ever before.

That's Birtley Group commitment.

[www.birtleygroup.co.uk](http://www.birtleygroup.co.uk)

## CONTENTS

- 4 SPH Joist Hangers
- 6 Maxi Speedy Joist Hangers
- 8 Speedy Joist Hangers
- 10 Restraint Straps
- 12 Joist Struts
- 13 Truss Clips
- 14 Framing Anchors
- 15 Angle Plates
- 16 Angle Brackets
- 19 Timber Connectors
- 20 Splice Plates
- 20 Timber Frame Cramps
- 21 BAT-U-Nail Plates
- 22 Multi-Purpose Fixing Bands
- 22 Junction Clips
- 23 Sole Plate Angles
- 23 Safe Plates
- 24 Wall Ties
- 34 Security Mesh
- 35 Exmet Brick Reinforcement
- 36 Flat Wire Reinforcement
- 37 Wall Starters & Multi-Starters
- 38 Accessories
- 39 Windpost Design Service

**Don't forget these other outstanding Expamet product ranges:**

### Plasterers Accessories

A range of metal and pvc beads and lath to suit any application

### BAT Windpost Systems

Designed on a project-by-project basis to meet exact requirements.

### BAT Masonry Support

Bracket and angle support systems can be tailored to meet individual designs.

### Hy-Rib

### Permanent Formwork

Proven through over 80 years in many prestigious building projects.

## SPH JOIST HANGERS

The BAT S.P.H. Joist Hanger is a single piece timber to masonry hanger for building into the inner leaf of external cavity walls and internal walls.



### Design Features

- Single-piece, non-welded construction.
- Wider masonry flange to increase loadings on masonry of compressive strength 2.8N/mm<sup>2</sup> and greater.
- Manufactured from 2mm thick pre-galvanized mild steel to BS EN 10346 : 2015, DX51D + Z600.
- 75mm load bearing surfaces.
- All hangers 150mm deep and over are manufactured 10mm less to allow for notching and regularisation of timber joists.
- Gusset nail holes are non coaxial.
- Standard available widths 38, 44, 47, 50, 63, 75, 89, 100, 125, 150mm.

### Installation Requirements

The back face of hanger must be flush against the wall.

The timber joist should be square cut and butting to the back face of the hanger (maximum permitted gap 6mm).

A minimum height of 675mm of set masonry must be in position above the supporting flange before any load is applied.

Fixing: Nail to the joist through the nail holes in each side gusset with BAT 3.75 x 30mm long square twisted sherardised nails.

It is recommended that joists are notched for the base of the hanger to achieve a level surface for plasterboarding.

Type 'R' and 'ST' provide additional location and alignment during construction.

HD Restraint Straps must be used with all types of SPH joist hangers if lateral restraint is required.

## SPH JOIST HANGERS

### How to Order/Specify

#### TYPE 'S'

Please state dimensions of joist

- depth
- width e.g. SPHS22550

Minimum box quantity dependent on hanger size.

#### TYPES 'R' & 'ST'

(made to order)

Please state dimensions of joist

- depth
- width
- top flange (to suit wall width) e.g. SPH22550R100

Quantity made to order

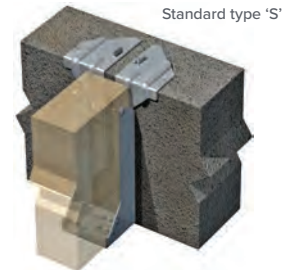

Standard type 'S'

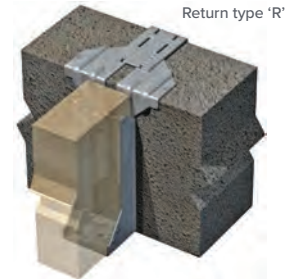

Return type 'R'

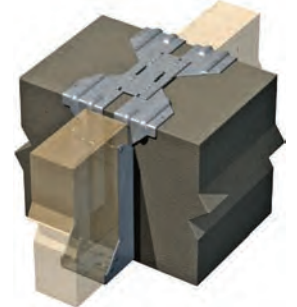

Straddle type 'ST'

### Need technical advice?

Call our expert team on 0330 404 9955 and they'll be pleased to help.

### Vertical load capacity (kN) – 3.5N/mm<sup>2</sup> masonry (SWL shown in brackets)

Joist Height	100	125	150	175	200	225	250	275
Width 38	10(5)	10(5)	10(5)	10(5)	10(5)	10(5)	10(5)	10(5)
Width 44	10(5)	10(5)	10(5)	10(5)	10(5)	10(5)	10(5)	10(5)
Width 47	10(5)	10(5)	10(5)	10(5)	10(5)	10(5)	10(5)	10(5)
Width 50	10(5)	10(5)	10(5)	10(5)	10(5)	10(5)	10(5)	10(5)
Width 63	10(5)	10(5)	10(5)	10(5)	10(5)	10(5)	10(5)	10(5)
Width 75	10(5)	10(5)	10(5)	10(5)	10(5)	10(5)	10(5)	10(5)
Width 89	10(5)	10(5)	10(5)	10(5)	10(5)	10(5)	10(5)	10(5)
Width 100	10(5)	10(5)	10(5)	10(5)	10(5)	10(5)	10(5)	10(5)
Width 125	14(7)	14(7)	14(7)	14(7)	14(7)	14(7)	14(7)	14(7)
Width 150	15(7.5)	15(7.5)	15(7.5)	15(7.5)	15(7.5)	15(7.5)	15(7.5)	15(7.5)

## MAXI SPEEDY JOIST HANGERS

The Maxi Speedy is a heavy duty hanger for the support of timber to timber or timber to masonry, concrete, etc. with provision for nailing or bolting.

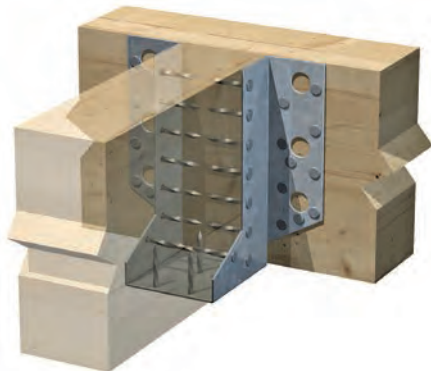

### Design Features

- Manufactured from pre-galvanized mild steel to BS EN 10346 : 2015, DX51D + Z275.

- Available in 7 types: MS240,335,380 - 1.2mm thick MS440,500,560,620 - 1.5mm thick

- Nail hole diameter : 4.5mm
- Bolt hole diameter : 14mm

- Available widths: 38, 47, 50, 63, 75, 100mm (122 + 150 for MS500, 560 + 620 only)

### Installation Requirements

Fixing: use BAT 3.75 x 30mm long square twisted sherardised nails.

M12 Bolts or coach screws as specified by fixing manufacturer.

### How to Order/Specify

1. Joist dimensions: Double joist depth and add joist width, ie for joist 225 deep x 38mm wide then: 225 (d) + 225 (d) + 38 (w) = 488mm.

2. The Maxi Speedy blank length must be less than total calculated in step 1, therefore select MS44038 (not MS500 as the joist hanger would stand proud).

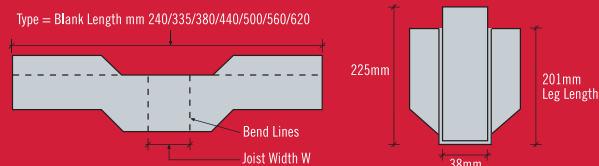

## MAXI SPEEDY JOIST HANGERS

Maxi Speedy Dimensions (mm)

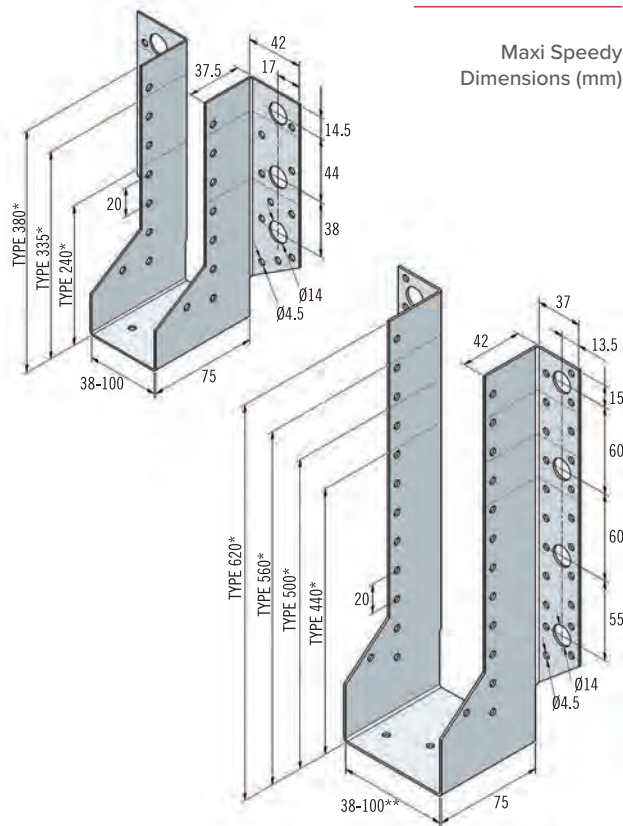

### Nail Fixing - Characteristic load capacity $F_k$ (kN) – C24 Timber

Joist Width	38	47	50	63	75	100	122	150
MS240	2.39	2.66	2.77	3.36	4.19	6.67		
MS335	4.87	5.44	5.66	6.86	8.55	11.68		
MS380	6.26	7.03	7.32	8.96	11.30	13.34		
MS440	8.89	9.96	10.37	12.65	15.89	20.31		
MS500	13.15	14.73	15.35	18.73	20.31	20.31	20.31	20.31
MS560	18.59	20.31	20.31	20.31	20.31	20.31	20.31	20.31
MS620	20.31	20.31	20.31	20.31	20.31	20.31	20.31	20.31

### Bolt Fixing - Characteristic load capacity $F_k$ (kN) – C24 Timber

Joist Width	38	47	50	63	75	100	122	150
MS240	4.50	5.57	5.92	7.46	8.88	11.84		
MS335	5.98	7.05	7.40	8.94	10.36	14.74		
MS380	7.46	8.53	8.88	10.42	11.84	17.60		
MS440	10.35	11.42	11.77	13.31	14.74	20.10		
MS500	13.27	14.34	14.69	17.06	20.31	20.31	20.31	20.31
MS560	16.75	18.79	19.59	20.31	20.31	20.31	20.31	20.31
MS620	20.31	20.31	20.31	20.31	20.31	20.31	20.31	20.31

# SPEEDY JOIST HANGERS

Speedy Joist Hangers provide a quick and safe method of joist trimming for light and medium duty joists.

## Design Features

- Speedy Hangers: 0.9mm thick pre-galvanized mild steel to BS EN 10346 : 2015, DX51D + Z275. Hole diameter: 3.8mm. LLS: 1.5mm thick material. SGTS: 1.2mm thick material.



- Girder/Girder Speedy: 3mm thick mild steel galvanized to BS EN 1461. Hole diameter : 22mm.

Fixing: use BAT 3.75 x 30mm long square twisted sherardised nails through all available nail holes.

## Speedy joist hangers – available sizes

Joist Width	38	44	47	50	63	75	80	91	100	105	120	155	Maximum Joist Depth
SM	•	•	•	•									100
SL	•	•	•	•									175
ST	•	•	•	•	•	•		•	•				225
SGTS	•	•	•	•	•	•							N/A
LLS	•	•	•	•	•	•		•	•				225
GGTS													N/A

## Characteristic load capacity $F_k$ (kN) – C24 Timber

Joist Width	38	44	47	50	63	75	91	100
Speedy Minor   SM	3.2		2.2	2.2				
Short Leg Speedy   SL	6.3	4.6	4.6	5				
Standard Leg Speedy   ST	8.5	7	6.7	6.7	6.9	7.1	7.1	7.4
Speedy Girder Truss Shoe   SGTS	10.7	12.3	12.8	12.6		11.2		
Long Leg Speedy*   LLS	7.6		7.6	7.6	7.6	7.6	7.6	9.6

\*6.7 kN when underslung by up to 100mm

### Speedy Minor

Depth ≤ 100  
 W = 38 : L = 70  
 W = 47 : L = 65  
 W = 50 : L = 64

### Short Leg Speedy

Depth ≤ 175  
 W = 38 : L = 191 : X = 76  
 W = 44 : L = 188 : X = 73  
 W = 47 : L = 188 : X = 71  
 W = 50 : L = 185 : X = 70

# SPEEDY JOIST HANGERS

### Standard Leg Speedy

Depth ≤ 225  
 W = 38 : L = 281 : X = 116  
 W = 44 : L = 278 : X = 113  
 W = 47 : L = 276 : X = 111  
 W = 50 : L = 275 : X = 110  
 W = 63 : L = 268 : X = 103  
 W = 75 : L = 262 : X = 97  
 W = 91 : L = 255 : X = 90  
 W = 100 : L = 250 : X = 85

### Long Leg Speedy

Depth ≤ 225  
 W = 38 : L = 396 : X = 137  
 W = 47 : L = 392 : X = 134  
 W = 50 : L = 380 : X = 131  
 W = 63 : L = 383 : X = 124  
 W = 75 : L = 377 : X = 118  
 W = 91 : L = 370 : X = 111  
 W = 100 : L = 365 : X = 106

### Speedy Girder Truss Shoe

W = 38 : L = 271 : X = 115  
 W = 44 : L = 268 : X = 112  
 W = 47 : L = 267 : X = 110  
 W = 50 : L = 265 : X = 109  
 W = 75 : L = 252 : X = 98

### Girder / Girder Speedy

W = 80 : L = 550 : X = 490  
 W = 105 : L = 550 : X = 490  
 W = 120 : L = 550 : X = 490  
 W = 155 : L = 550 : X = 490

## RESTRAINT STRAPS

BAT straps are manufactured in two types. Heavy Duty to provide horizontal restraint and Standard to provide vertical restraint against uplift forces.



Heavy Duty Restraint Strap

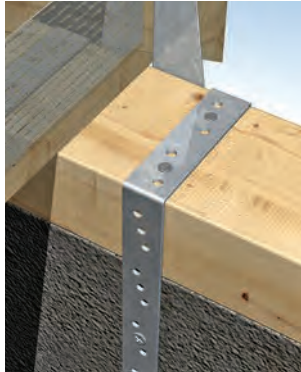

Standard Restraint Strap

### Design Features

- The straps are manufactured from pre-galvanized steel strips to BS EN 10346 : 2015, S250GD + Z600 or stainless steel to BS EN 10088-1 : 2014 : 1.4301.

- Nominal Dimensions  
Heavy Duty - 27.5 x 4mm  
Standard - 27.5 x 2mm

### Need technical advice?

Call our expert team on 0330 404 9955 and they'll be pleased to help.

### Installation Requirements

Installation must comply with Building Regulations, PD6697 and BS 8103 : Part 1, as well as NHBC recommendations.

If straps are fixed across joists or trussed rafters which are parallel with the wall, and there is a gap between the wall and the first joist or truss, the gap must be packed. Noggins must be used between each joist or truss.

Fixing for horizontal restraint: 5 no 4 x 75 round wire nails 1 per noggin, 1 per joist. Strap must cross 3 joists.

Fixing for vertical restraint: Wallplate - 2 no 3.75 x 30 square twisted nails. Blockwork - 4 no M5 x 50 wood- screws into nylon wall plugs, one of which within 150mm from the bottom. For stainless steel straps, stainless steel fixings must be used.

## RESTRAINT STRAPS

Fixing Hole Layout

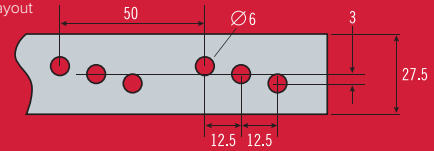

How to order

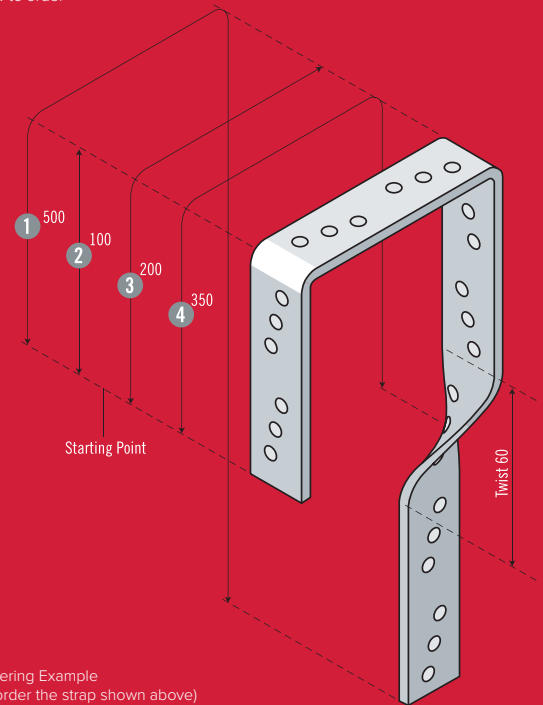

Ordering Example  
(to order the strap shown above)

		1	2	3	4
Strap Type		Total Strap Length 500	Bend at 100	Bend at 200	Twist at 350
Order Reference	<b>HD</b>	<b>0500</b>	<b>B100</b>	<b>B200</b>	<b>T350</b>
Options	<b>ST</b> Standard <b>HD</b> Heavy Duty	4 digits (mm)	S = Straight B = 90° Bend T = 90° Twist Distance from Start (mm)		

Twists are clockwise as shown above unless otherwise specified.

If in doubt, please provide a sketch of what is required,

## HERRINGBONE JOIST STRUTS

Herringbone Joist Struts provide stability to floor joists and significantly reduce labour compared with timber strutting.

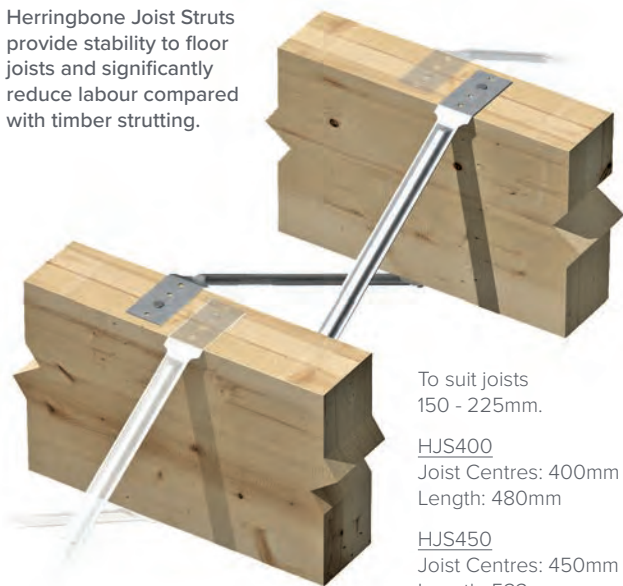

To suit joists  
150 - 225mm.

**HJS400**  
Joist Centres: 400mm  
Length: 480mm

**HJS450**  
Joist Centres: 450mm  
Length: 523mm

**HJS600**  
Joist Centres: 600mm  
Length: 660mm

### Specification:

Manufactured from 0.9mm thick pre-galvanized mild steel to BS EN 10346 : 2015, DX51D + Z275. Hole diameter: 4mm Qty per box: 50

### Installation Requirements

Joist Span – 2.5m to 4.5m  
1 Row at mid span

Greater than 4.5m  
2 Rows at 1/3 span positions

Recommended fixing:  
BAT 3.75 x 30mm long square twisted sherardised nails.



Fix with single 3.75 x 30mm sherardised square twisted nail per strut end

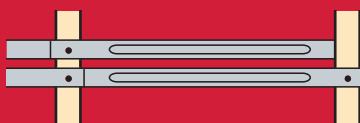

When fixing the second strut a 6mm (approx) gap should be kept between the struts.

## TRUSS CLIPS

The Bat Truss Clip eliminates the disadvantages of skew nailing trussed rafters to timber wall plates: damaged connector plates, split rafters or wall plates.

**TC38**  
for 38mm trusses

**TC50**  
for 50mm trusses

Wider trussed rafters may be fixed using pairs of BAT Framing Anchors, types MFAAL and MFAAR as shown overleaf.

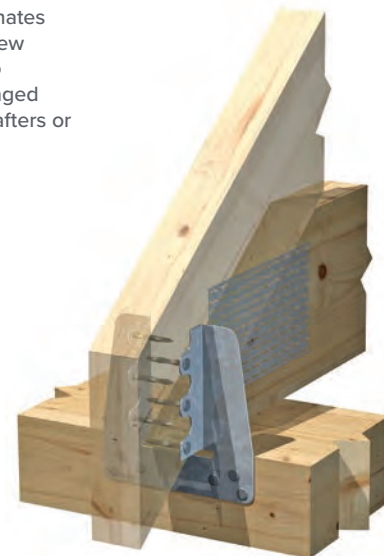

### Specification:

Manufactured from 0.9mm thick pre-galvanized mild steel to BS EN 10346 : 2015, DX51D + Z275. Overall height: 117mm Overall width: 114mm Hole diameter: 4mm Qty per box: 200

### Installation Requirements

Use BAT 3.75 x 30mm long square twisted sherardised nails.

Uplift - 38mm - 2.7 kN  
Uplift - 50mm - 1.6 kN

All nail holes must be filled.

The timber wall plate must be securely held down onto the supporting masonry.

Characteristic load bearing capacity ( $F_{Rk}$ ):

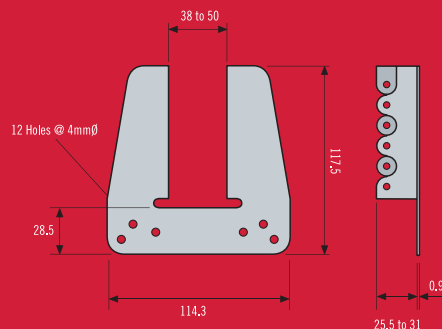

## FRAMING ANCHORS

BAT Multi-Grip Framing Anchors offer the most effective and economical method of providing strong, mechanical joints for framing of timbers.

### MFAAL & MFAAR

for anchoring rafters and trusses to wall plate.

### MFABL & MFABR

for anchoring headers to studs, beams to posts and studs to plates.

### MFAC

for right or left handed use – for anchoring joists to beams, stringers to headers and hip joints.

### Specification:

Manufactured from 0.9 mm thick pre-galvanized mild steel to BS EN 10346 : 2015, DX51D + Z275.

Overall height: 127mm  
Overall width: 38mm  
Hole diameter: 3.8mm  
Qty per box: 200

### Characteristic load capacity ( $F_k$ ) C24 Timber

Loading Arrangement	Product Type	Load (kN)
Shear Capacity (per pair)	MFAAL/MFAAR	2.1
	MFABL/MFABR	3.37
Uplift Capacity	MFAC	6.4
	MFAAL/MFAAR	3.38
	MFABL/MFABR	3.01
	MFAC	N/A

### Installation Requirements

Always use in pairs to prevent eccentric loading.

Recommended fixing: BAT 3.75 x 30mm long square twisted sherardised nails.

Fixings should be used in all available timber facing holes.

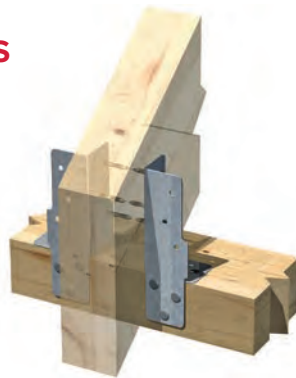

MFAAL / MFAAR  
(left and right handed versions)



MFABL / MFABR  
(left and right handed versions - MFABR shown)



MFAC

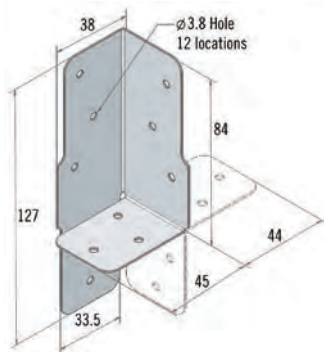

## ANGLE PLATES

BAT Angle Plates are used as a safe and economical method of connecting joists to purlins.

### AP30030

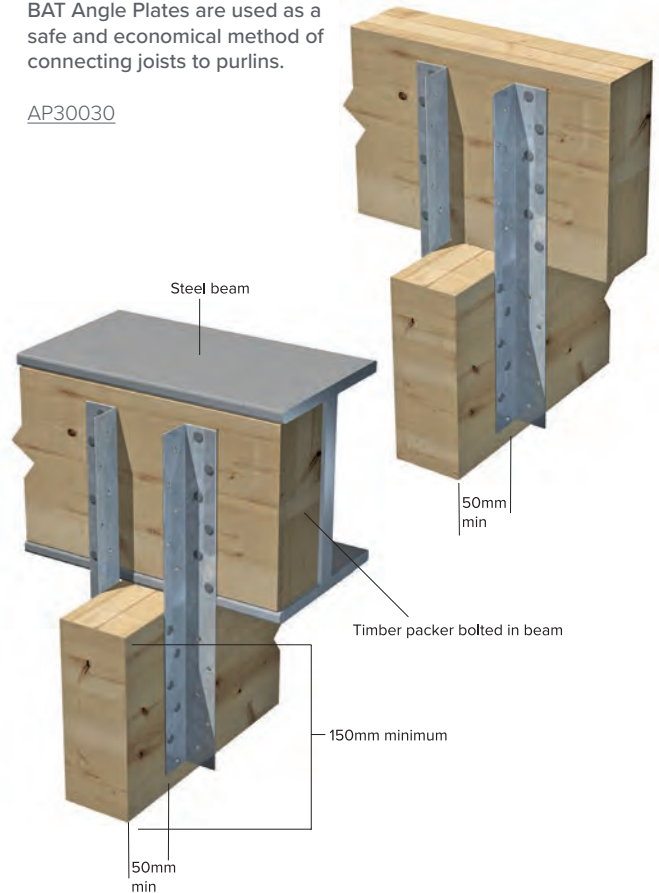

### Specification:

Manufactured from 2mm thick hot dipped pre-galvanized mild steel to BS EN 10346 : 2015, DX51D + Z275.

Length: 300mm  
Width each wing: 30mm  
Hole diameter: 4mm  
Qty per box: 50

Characteristic load capacity  $F_k$  - C24 timber

1 pair - 6.8kN  
2 pairs - 16.8kN

### Installation Requirements

Fixing: use BAT 3.75 x 30mm long square twisted sherardised nails.

Fixings should be used in all timber facing nail holes.

Minimum timber depth of 150mm.

Ensure the timbers project a minimum of 50mm beyond the Angle Plates.



## ANGLE BRACKETS

BAT Angle Brackets are designed for multi-purpose fixing applications and can be used as replacement cleats, nailed or bolted.

### Design Features

- Manufactured from hot dipped pre-galvanized mild steel to BS EN 10346: 2015, DX51D/S250GD + Z275.



### Installation Requirements

Angle Brackets may be used for timber/timber, timber/steel and timber/masonry connections.

Brackets may be fixed with screws, nails, bolts or coach screws.

Must be used in pairs to prevent eccentric loading.

AB303015  
CSK for screws  
Max M3.5 x 4  
Qty: 100

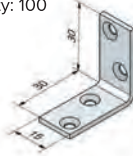

AB404040\*  
Ø5 x 8  
Qty: 100

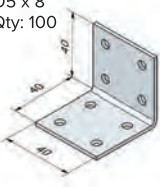

AB505035  
Ø4 x 9  
Qty: 100

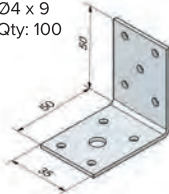

AB604060\*  
Ø4.5 x 12  
Ø7 x 2  
Ø11 x 1  
11\*30 x 1  
Qty: 100

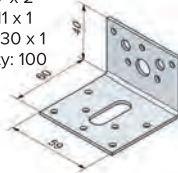

AB804042  
Ø4 x 6  
Ø7 x 2  
11\*30 x 1  
Qty: 50

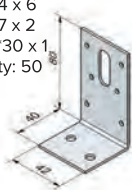

AB808018  
CSK for screws  
Max M4 x 4  
Qty: 50



AB906059  
Ø4 x 12  
Ø9 x 4  
11\*30 x 1  
Qty: 50

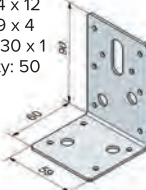

AB909060  
Ø4 x 16  
Ø9 x 4  
Ø11 x 1  
11\*30 x 1  
Qty: 50

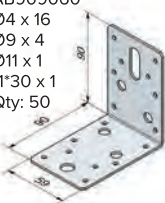

AB1006060\*  
Ø5 x 20  
Ø11 x 3  
Qty: 50

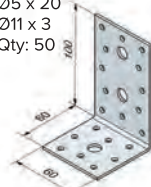

AB12512542  
Ø4 x 16  
Qty: 50



## ANGLE BRACKETS

AB1509059  
Ø4 x 21  
Ø9 x 4  
Ø11 x 1  
11\*30 x 2  
Qty: 50

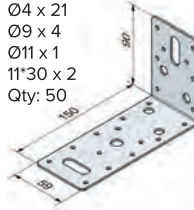

AB15015063  
Ø4 x 20  
Ø9 x 6  
11\*30 x 2  
Qty: 50

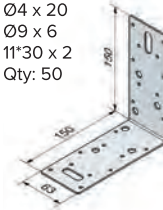

HD9090\*  
Ø4 x 16  
Ø9 x 4  
Ø11 x 1  
11\*30 x 1  
Qty: 50

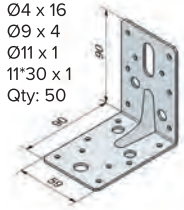

HD15090\*  
Ø4 x 21  
Ø9 x 4  
Ø11 x 1  
11\*30 x 2  
Qty: 50

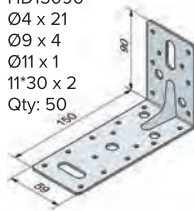

HD150150\*  
Ø4 x 20  
Ø9 x 6  
11\*30 x 2  
Qty: 40

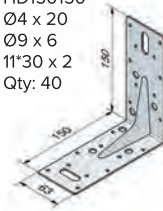

AAB1403540\*  
Ø5 x 15  
Ø11 x 3  
9\*30 x 1  
Qty: 50

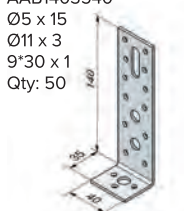

AAB806520  
Ø6.5 x 2  
6.2\*52 x 1  
Qty: 20  
4mm thick



NPA767676  
Use SN32 x 24 no  
Qty: 50

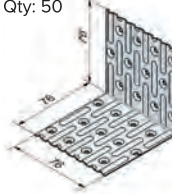

NPA575751  
Use SN32 x 12 no  
Qty: 50

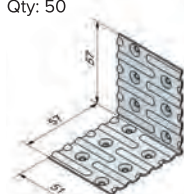

AP2103030  
Ø4 x 22  
Qty: 50

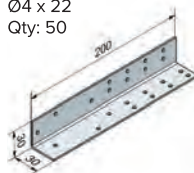

T1408030  
CSK for screws  
Max M4.5 x 6  
Qty: 20

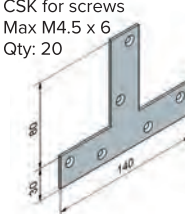

L12012020  
CSK for screws  
Max M3.5 x 5  
Qty: 20

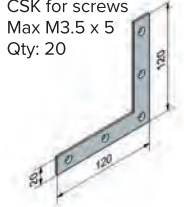

JP17559  
Ø4 x 16  
Ø9 x 4  
Ø11 x 1  
11\*30 x 1  
Qty: 50

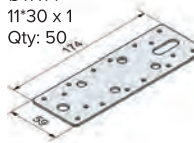

JP46250  
Ø4 x 16  
Qty: 50

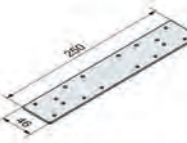

JP63300  
Ø4 x 20  
Ø9 x 6  
11\*30 x 2

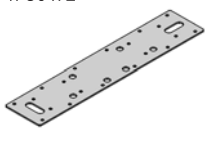

## ANGLE BRACKETS

Characteristic load capacity of angle brackets  $F_k$  (kN)

Note: load values shown are per pair of brackets.

Brackets are not to be used individually in structural applications.

**AB404040**  
4 x 40 annular ring shank nail  
6 x minimum in holes indicated to achieve loads

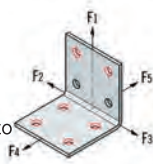

Load Condition	Load (C16 timber)
F1 Uplift	1.24
F2,3 Shear	3.52
F4,5 Shear	1.72

**AB604060**  
3.75 x 30 square twisted nail (SN32)  
12 x minimum in holes indicated to achieve loads

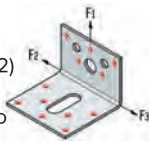

Load Condition	Load (C24 timber)
F1 Uplift	4.17
F2,3 Shear	5.69

**AB1006060**  
4 x 40 annular ring shank nail  
15 x minimum in holes indicated to achieve loads

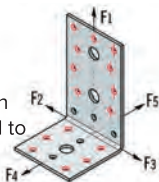

Load Condition	Load (C16 timber)
F1 Uplift	2.37
F2,3 Shear	7.93
F4,5 Shear	3.55

**AAB1403540**  
4 x 40 annular ring shank nail  
13 x minimum in holes indicated to achieve loads

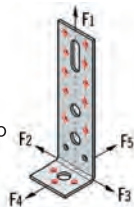

Load Condition	Load (C16 timber)
F1 Uplift	0.91
F2,3 Shear	3.27
F4,5 Shear	2.1

**HD9090**  
3.75 x 30 square twisted nail (SN32)  
16 x minimum in holes indicated to achieve loads

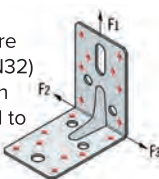

Load Condition	Load (C24 timber)
F1 Uplift	2.79
F2,3 Shear	4.6

**HD15090**  
3.75 x 30 square twisted nail (SN32)  
21 x minimum in holes indicated to achieve loads

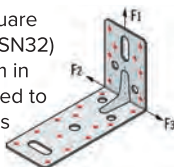

Load Condition	Load (C24 timber)
F1 Uplift	1.7
F2,3 Shear	6.07

**HD150150**  
3.75 x 30 square twisted nail (SN32)  
20 x minimum in holes indicated to achieve loads

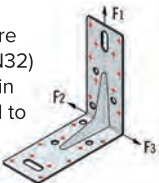

Load Condition	Load (C24 timber)
F1 Uplift	1.67
F2,3 Shear	6.07

## TIMBER CONNECTORS

**BAT Timber Connectors** are compliant with BS EN 912:2000 'specification for connectors for timber'. Safe working loads, end distances and spacing are all set out in BS 5268 Part 2.

### Shear Plate

SPT67 (B2) x 150 per box  
SPT102 (B3) x 50 per box  
Designed for use with M20 bolt.  
67mm – Galvanized hot rolled steel to BS EN 10025.  
100mm – Galvanized cast iron to BS EN 1562.

### Square Plate Washers

SPW50 (50mm square).  
To suit 12mm bolt. 250 per box.

### Tooth Plate (Round)

50, 63 and 75 diameter.  
200, 150 and 100 per box respectively.  
Available in both single and double sided, eg. ref.TCSS (C6); TCDS (C7) etc.  
Suitable for M12 bolt.  
Pre-galvanized steel to BS EN 10346 : 2015 DX51D + Z275.

### Split Ring

SRTC64 (A3) x 100 per box  
SRTC102 (A3) x 100 per box  
Designed for use with M12 and M20 bolts respectively.  
Double bevelled.

Manufactured from galvanized hot rolled steel to BSEN10025.

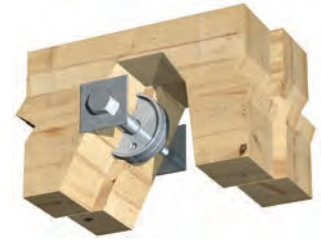

Shear Plate 67



Shear Plate 102

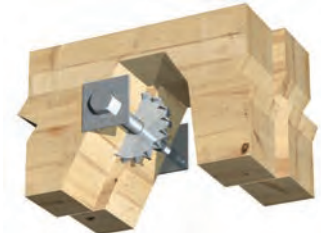

Tooth Plate (Round)



Split Ring

Application Tools for use with timber connectors. Available to special order.

Reference	Type	Size
SRGT/64	Split Ring Grooving & Dapping Tool	64mm split ring
SRGT/102	Split Ring Grooving & Dapping Tool	102mm split ring
DT/67	Shear Plate Grooving & Dapping Tool	67mm shear plate
DT/102	Shear Plate Grooving & Dapping Tool	102mm plates

## SPLICE PLATES

- Minimum timber thickness 50mm.
- All fixing nails included.
- 8 sets of 4 per box. (L61/L80)
- 4 sets of 4 per box. (L98)

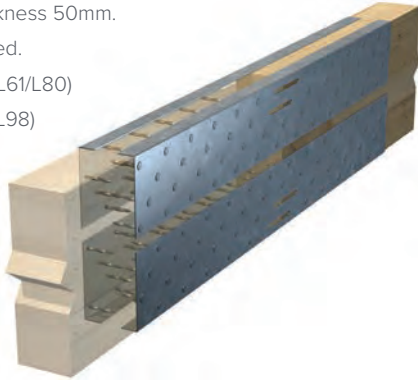

Reference	Size (mm)	Joist Depth (mm)	SLS Resistance Moment (kN)	SLS Shear Capacity (kN)	Aprox. Nails Per Plate
L61	18 x 61 x 400	125/150	1.5	13	27
L80	18 x 80 x 560	175/200	1.5	13	52
L98	18 x 98 x 560	225/250	1.5	13	65

## FRAME CRAMP

To provide positive location and support of window from timber framing to resist wind and incidental loadings.

### Design Features

• Manufactured from 0.9mm thick hot dipped galvanized mild steel to BS EN 10346 : 2015 DX51D + Z275.

- Box quantity 100



### Installation Requirements

Fixing: use BAT 3.75 x 30mm long square twisted sheradised nails.

Ref.	Width	Length	Upstand
FC1	76mm	202mm	
FC2	76mm	212mm	40mm

## BAT-U-NAIL PLATE

BAT-U-Nail is a plate system which enables timber structures to be made on site or in the builders workshop, since it is nailed by hand.

### Design Features

- Manufactured from 0.9mm pre-galvanized mild steel to BS EN 10346: 2015 : DX51D + Z275.
- Widths: 76, 114 and 152mm
- Lengths: 51, 100, 152, 203, 254, 305 and 354mm.
- Various quantities per box. Ref. eg. BP7651.



### Installation Requirements

BAT-U-Nail plates are to be fixed on both sides of the timber. Fixing: use BAT 3.75 x 30mm long square twisted sheradised nails. Loading in the direction of the plate stiffening ribs.

- 345 N/nail (parallel to timber grain).
- 145 N/nail (perpendicular to timber grain).

Plate compression value 40 N/mm width of plate. To calculate capacity of connections, the lesser of anchorage, plate compression and tension should be taken.

Fix in accordance with BS 5268 : Part 2.

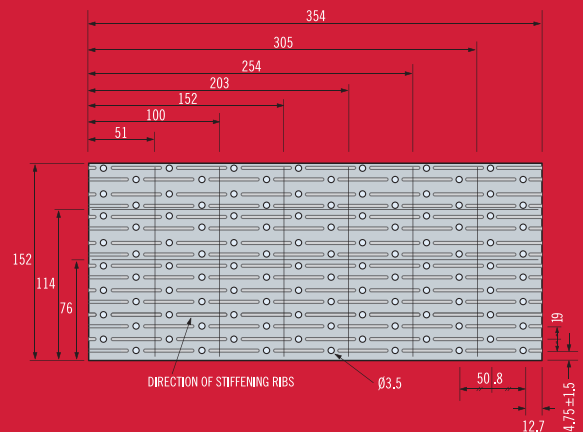

## MULTI-PURPOSE FIXING BANDS

Expamet Fixing Band is an easy-to-use coil strip designed for all types of light fixing applications.

### Design Features

- Manufactured from hot dipped galvanized mild steel to BS EN 10346 : 2015 DX51D + Z275.
- Stainless steel (MFBASS)



### Installation Requirements

Fixing: use BAT 3.75 x 30mm long square twisted sherardised nails, screws or bolts. Not to be used below ground.

Ref.	Width	Thickness	Length
MFBA	20mm	0.9mm	10m
MFBB	20mm	0.7mm	10m
MFBASS	20mm	0.9mm	10m

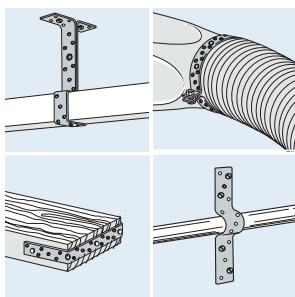

## JUNCTION CLIP

Can be used instead of noggins, at wall junctions and at contact points between ceiling and walls when fitted at 300mm centres.

### Design Features

- Manufactured from 0.9mm hot dipped galvanized mild steel to BS EN 10346 : 2015 : DX51D + Z275. Ref: JC1 250 per box.



### Installation Requirements

Fixing: use BAT 3.75 x 30mm long square twisted sherardised nails or ordinary plasterboard nails.

## SOLE PLATE ANGLES

BAT Sole Plate Angles positively locate timber sole plates to concrete floor slabs using masonry fixings as required, without penetrating the dpc.

### Design Features

- Manufactured from 0.9mm thick hot dipped galvanized mild steel to BS EN 10346 : 2015 DX51D + Z275.

- Box quantity 100

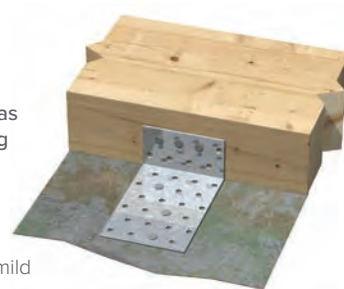

### Installation Requirements

BAT Sole Plate Angles may be fixed on the inside of the sole plate or alternatively fixed under the sole plate with the upstand on the outside of the sole plate.

Fixing: use 3.75 x 50mm min. length nails/masonry nails.

Ref.	Width	Length	Upstand
SPA112	76mm	112mm	40mm
SPA162	76mm	162mm	40mm

## SAFE PLATE

For protection of plumbing and electrical wiring against random nailing into studs.

### SAF1

90 x 54mm

### Design Features

- Manufactured from 0.9mm hot dipped galvanized mild steel to BS EN 10346 : 2015 : DX51D + Z275.

- 200 per box

### Installation Requirements

Use wherever services occur within 75mm of face of plasterboard or 100mm of surface of floor deck.  
Fixing: Tap in with hammer.

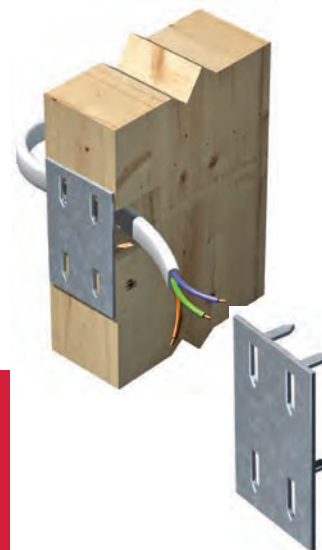

## STAINLESS STEEL WALL TIES

Expamet wall ties are compliant with BS EN 845 –1 the specification for ancillary components for masonry, Part 1: ties, tension straps, hangers and brackets.

Wall ties should be installed in accordance with PD6697, recommendations for the design of masonry structures to BS EN 1996-1-1 and BS EN 1996-2.

Stainless steel type 1.4301 to BS EN 10088-1.

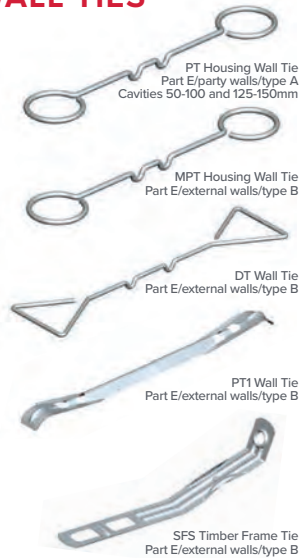

SSCD Insulation Retaining Disc



Code	Nominal Cavity Width (mm)	Qty	Type	Description
PT200#50	75	5 x 50	Type 4	200mm Housing Wall Tie
PT200	75	250	Type 4	200mm Housing Wall Tie
PT225#50	100	5 x 50	Type 4	225mm Housing Wall Tie
PT225	100	250	Type 4	225mm Housing Wall Tie
PT250	125	250	Type 4	250mm Housing Wall Tie
PT275	150	250	Type 4	250mm Housing Wall Tie
MPT200#50	75	5 x 50	Type 2	200mm General Purpose Wall Tie
MPT200	75	250	Type 2	200mm General Purpose Wall Tie
MPT225#50	100	5 x 50	Type 2	225mm General Purpose Wall Tie
MPT225	100	250	Type 2	225mm General Purpose Wall Tie
MPT250	125	250	Type 2	250mm General Purpose Wall Tie
PT1-200	75	250	Type 1	200mm Heavy Duty Wall Tie
PT1-225	100	250	Type 1	225mm Heavy Duty Wall Tie
PT1-250	125	250	Type 1	250mm Heavy Duty Wall Tie
PT1-275	150	250	Type 1	275mm Heavy Duty Wall Tie
PT1-300	150	250	Type 1	300mm Heavy Duty Wall Tie
DT200	75	250	Type 2	200mm Double Triangle Wall Tie
DT225	100	250	Type 2	225mm Double Triangle Wall Tie
DT250	125	250	Type 3	250mm Double Triangle Wall Tie
DT300	150	250	Type 3	300mm Double Triangle Wall Tie
SSCD		250		Insulation Retaining Disc. Fits all Ties
SSFS50	50	250	Type 6	Timber Frame Tie including nail
SSFS75	75	250	Type 6	Timber Frame Tie including nail
SSFS100	100	250	Type 6	Timber Frame Tie including nail

## STAINLESS STEEL SCREW-IN STARTER AND CAVITY TIES

A quick and easy way to tie new walls to existing walls.

Screw-in starter and cavity ties are made from austenitic stainless steel to BS EN 10088-3.

Nominal cavity width for SCT: 50 - 100mm.

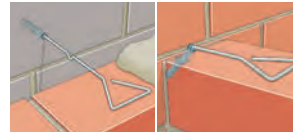
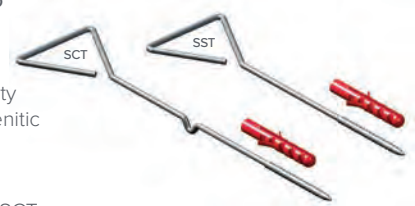

Supplied with masonry plug.

Code	Length (mm)	Qty	Description
SST130#10	130	10	Screw-in starter tie
SST130	130	100	Screw-in starter tie
SCT150	150	100	Screw-in cavity tie with V drip
SCT180	180	100	Screw-in cavity tie with V drip
SCT200	200	100	Screw-in cavity tie with V drip
SCT225	225	100	Screw-in cavity tie with V drip

## STAINLESS STEEL SCREW-IN FRAME TIE

Screw-in frame ties secure timber window and door frames to inner leaf of masonry.



Code	Length (mm)	Qty	Material
SIFT130RT	130	100	Stainless Steel
SIFT130#10	130	10 bags of 10	Stainless Steel

## FRAME CRAMPS

A comprehensive range of stainless steel frame cramps with safety end or plain end options for fixing to concrete, steel and masonry.

V-drip and vertical twists are offered as options and drips can be offset to accommodate insulation materials.

Compliant with BS EN 845-1

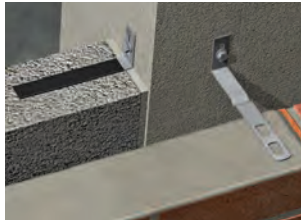

Code	Lengths available (mm)	Upstand	Description
SEPE...	150/200/225/250	n/a	Movement tie
SESE...	150/200/225/250/300	n/a	Double safety end fixing
SESE...V	150/200/225/250/300	n/a	Dbt sfty end with 'V' drip
PEFC...30H	100/125/150	30	Plain end frame cramp
SEFC...30H	75/ 100/125/150/175/200	30	Frame cramp
SEFC...30HV	125/150/200/300	30	Frame cramp with 'V' drip
PEFC...50S	100/125/150	50	Plain end frame cramp
SEFC...50S	75/150/200/300	50	Frame cramp
SEFC...50SV	125/150/200/300	50	Frame cramp with 'V' drip
20022	100*	n/a	Debonding sleeve

\* Other sizes available - please call for more information

## POWER-TIE STAINLESS STEEL SLIDING ANCHOR STEMS & TIES

Where cavity walls are to be restrained at soffit levels it is usual to allow for the variable vertical movements of dissimilar structural materials (ie. Steel, Concrete, Brick, Blockwork), throughout the lifetime of the building.

Stem lengths / no. of ties to be specified.

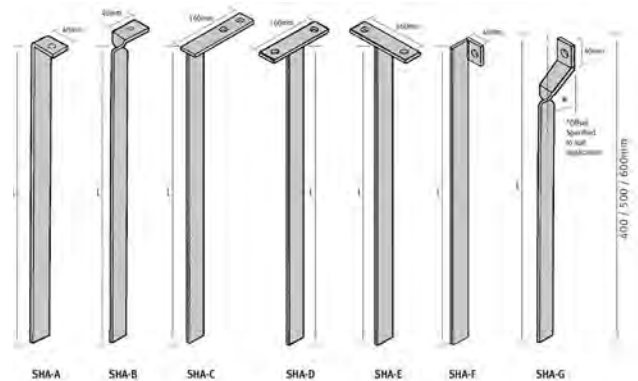

Anchor stems

Order Example: **SHA-A600** - Stainless steel sliding anchor stem, type A, 600mm long.

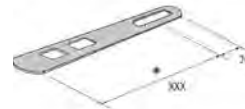

One Way Tie **SATOW XXX**

Length and slot position to be specified as required.

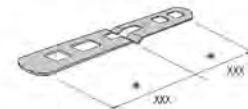

Two Way Tie **SATTW XXX XXX**

\*Projections to suit stem position in cavity - allow 62.5 - 75mm embedment. Sold as singles.



Visit [www.expamet.co.uk](http://www.expamet.co.uk) to view our bespoke windposts and masonry support services

### Need technical advice?

Call our expert team on 0330 404 9955 and they'll be pleased to help.

## POWER-TIE FRAME, SPECIAL & REMEDIAL TIES

power-tie

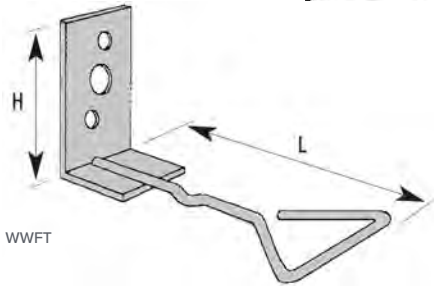

WWFT

Ref.	Description	Size (mm)	Quantity
WWFT125	Welded wire frame tie	L:125 / H:50	250
WWFT150	Welded wire frame tie	L:150 / H:50	250
WWFT300	Welded wire frame tie	L:300 / H:50	250
WWCT125	Welded wire clasp tie	L:125	250
WWCT150	Welded wire clasp tie	L:150	250
WWCT300	Welded wire clasp tie	L:300	250

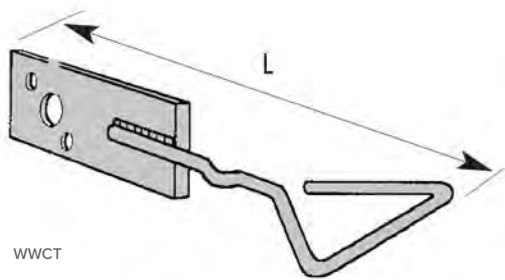

WWCT

Ref.	Description	Size (mm)	Quantity
SEFC150#125	Safe edge frame cramp	L:100 / H:50	125
SEFC200#125	Safe edge frame cramp	L:150 / H:50	125
SEFC250#125	Safe edge frame cramp	L:200 / H:50	125

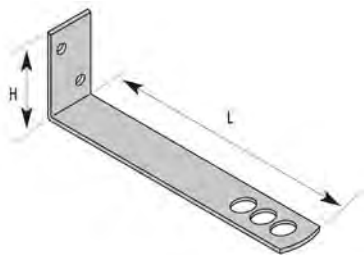

SEFC

## POWER-TIE FRAME, SPECIAL & REMEDIAL TIES

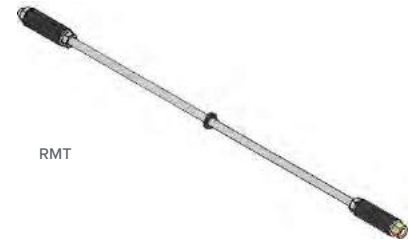

RMT

Ref.	Description	Nominal Cavity Width (mm)	Quantity
RMT175	175mm Mechanical/Mechanical tie	Solid walls	250
RMT200	200mm Mechanical/Mechanical tie	50-75	250
RMT225	225mm Mechanical/Mechanical tie	76-100	250
RMT250	250mm Mechanical/Mechanical tie	101-125	250
RMT300	300mm Mechanical/Mechanical tie	126-150	250

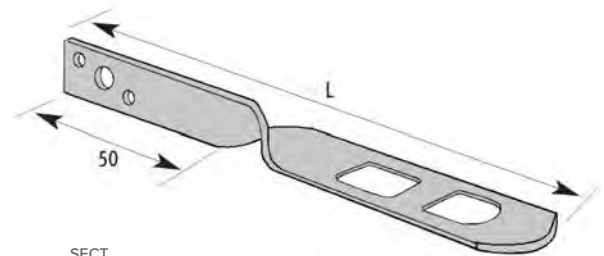

SECT

Ref.	Description	Size (mm)	Quantity
SECT150	Safety end clasp tie	L:150	200
SECT175	Safety end clasp tie	L:175	200
SECT200	Safety end clasp tie	L:200	200
SECT225	Safety end clasp tie	L:225	200
SECT300	Safety end clasp tie	L:300	200



Visit [www.expamet.co.uk](http://www.expamet.co.uk) to view our bespoke windposts and masonry support services

## SLIDING HEAD RESTRAINT SHRS/SHRH

power-tie

Ref.	Fixing
SHRS	Slot 25 x 10
SHRH	Hole 10

1.4301 Austenitic Stainless Steel to BS EN 10088-2 : 2014

### Performance

Tested by Lucideon with maximum declared load calculation based on the required performance of a shear tie as given in BS EN 845-1: Specification for ancillary components for masonry - Part 1: Ties, tension straps, hangers and



Test	Declared load (ULS) at 215mm embedment
Shear	4.5

### Features

Telescopic concealed anchor provides shear restraint to the wall head of non load bearing walls whilst allowing differential movement between the structure above and the masonry below. Friction grip assembly facilitates masonry construction by holding the built-in sleeve in a raised position while laying the masonry below. Masonry embedment marking for 25mm clearance to soffits above. Slotted (SHRS) or holed (SHRH) anchorage. Depth to suit standard 215mm block. Other depths available to special order.

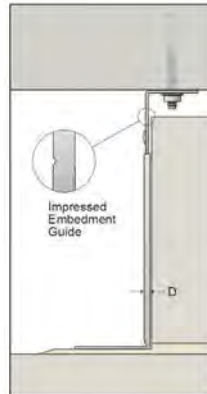

## 25/14 CHANNEL TIE SYSTEM

Ref.	Projection Length (mm)	Residual Cavity (mm)
2514S100V	100	50
2415S125V	125	75
2415S150V	150	100
2415S175V	175	125
2415S200V	200	150

1.4301 Austenitic Stainless Steel to BS EN 10088-2 : 2014. Supplied in boxes of 200.

### Performance

Channel tie system for use on steel framed buildings insulated with rigid boards. Easy turn-and-slide tie can be positioned at any height along channel. Ties are designed to clear internal screw fasteners anchoring channel through pre-punched fixing holes.

### Accessories

Channel section

2700mm pre-punched stainless steel reference 25-14-2700

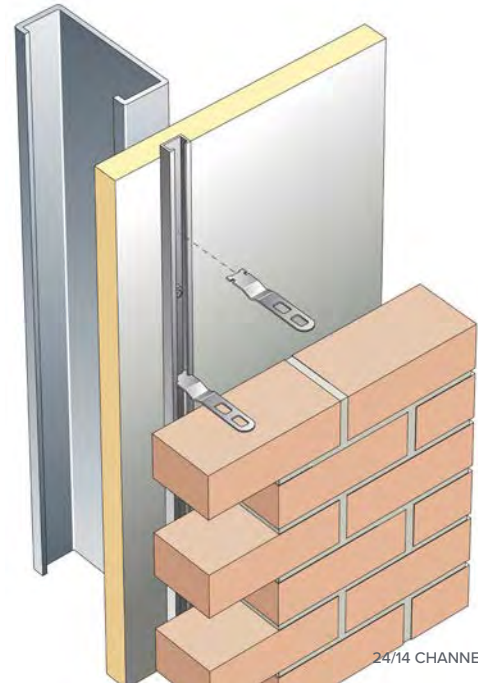

25/14 CHANNEL SYSTEM



## 2 PART TIE



Male Tie Ref.

Female Tie Ref.	Structural Cavity 150 - 250				
	150	175	200	225	250
2PTF- 175	2PTM 125	2PTM 150	2PTM 175	2PTM 200	2PTM 225
2PTF- 200	2PTM 100	2PTM 125	2PTM 150	2PTM 175	2PTM 200

Male Tie Ref.

Female Tie Ref.	Structural Cavity 275 - 400					
	275	300	325	350	375	400
2PTF- 175	2PTM 250	2PTM 275	2PTM 300	2PTM 325	2PTM 350	2PTM 375
2PTF- 200	2PTM 225	2PTM 250	2PTM 275	2PTM 300	2PTM 325	2PTM 350

1.4301 Austenitic Stainless Steel to BS EN 10088-2 : 2014. Tie parts supplied individually.

Wider cavities require longer wall ties which create a potentially hazardous projection and are susceptible to sagging when only one leaf is built.

The two part tie overcomes these concerns by minimising the wall tie projection until the installation of the male tie extension when the second leaf is built.

The two part tie consists of female 2PTF and male 2PTM components whose combinations cater for nominal cavity widths between 150mm and 400mm.



## FIXED HEAD RESTRAINT FHR100140

Ref.	Fixing hole (mm)	Height (mm)
FHR100140	9	70

1.4301 Austenitic Stainless Steel to BS EN 10088-2 : 2014. Supplied in boxes of 40.

### Features

Provides shear restraint to the wall head of non load bearing walls whilst allowing differential movement between the structure above and the masonry below.

Pre-punched top section to suit both 100mm and 140mm thick blockwork.

Shear Capacity (ULS) 5kN

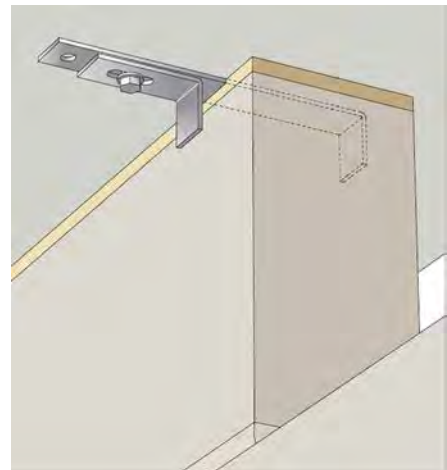
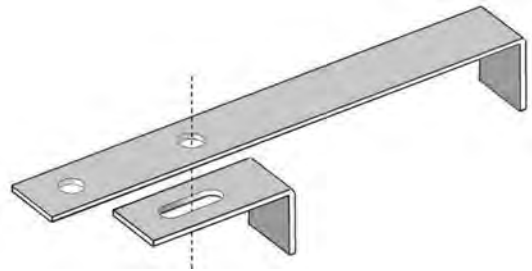

## SECURITY MESH

A cost effective way of securing buildings or internal spaces by sandwiching a layer of steel mesh into the walls and ceilings during construction.

Available in a range of gauges this high quality security mesh is suitable for internal walls, ceilings, partitions and external brickwork. It can also be provided in galvanized steel, where damp conditions are expected.

See our full range of expanded metal and lath at

[www.expamet.co.uk](http://www.expamet.co.uk)

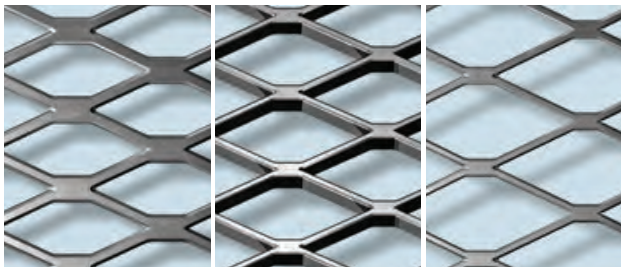

50-73HFG / 50-73HF

50-89HRG / 50-89HR

50-76MFG / 50-76MF

Ref.	Security Mesh Type	Mesh LW	Mesh SW	Strand Width	Strand Thickness	Weight Kg/m <sup>2</sup>	Sheet Size
50-73HFG	Flattened Galvanized Mild Steel	42.9"	14.2"	4.6	2.7	8.59	2440 x 1220
50-89HRG	Raised Galvanized Mild Steel	50.8"	22.6"	3.1	3.0	6.52	2440 x 1220
50-76MFG	Flattened Galvanized Mild Steel	43.4"	18.0"	2.3	1.1	1.85	1250 x 2440
50-73HF	Flattened Mild Steel	42.9"	14.2"	4.6	2.7	8.59	2440 x 1220
50-89HR	Raised Mild Steel	50.8"	22.6"	3.1	3.0	6.52	2440 x 1200
50-76MF	Flattened Mild Steel	43.4"	18.0"	2.3	1.1	1.85	1250 x 2440

\* Mesh pitch size

## EXMET REINFORCEMENT

Stainless steel Exmet is manufactured from austenitic stainless steel 1.4301 to BS EN 10088-1.

Coil length: 20m.

Expanded steel mesh with no joints or interweaving to fail under stress.

For non-structural applications.

Overlap ends: 75mm.

Designed to prevent cracking around the windows and door openings.

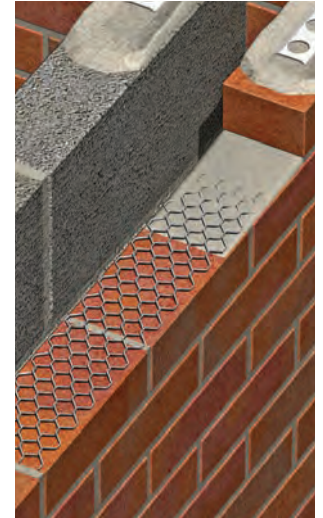

### Need technical advice?

Call our expert team on 0330 404 9955 and they'll be pleased to help.

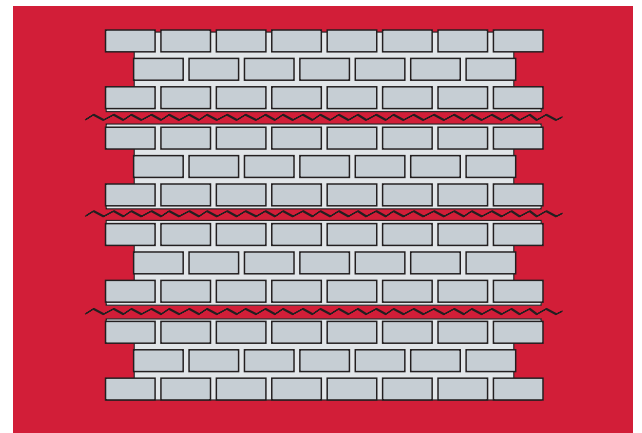

Ref.	Material Thickness (mm)	Coil Size Width (mm)	Wall Width (mm)	Quantity
76820	0.3	65	100	5
76920	0.3	115	140	5
77020	0.3	175	225	1
77120	0.3	225	265	1

## FLAT WIRE REINFORCEMENT

Flat Wire Ladder Reinforcement is made from austenitic stainless steel to 1.4301 : BS EN 10088-3. Ladder length 2700mm.

Type: single leaf.  
Conforms to BS 5628-2 and BS 845-3. 500N/mm<sup>2</sup> minimum tensile strength.

Special designs are available on request for corners and T-shapes.

Overlap ends 225mm.

20 lengths per bundle.

For structural applications.



Ref.	Main Wire Height (mm)	Equivalent Round Wire Diameter (mm)	Ladder Width (mm)	Wall Width (mm)	Qty
SBSF3060	2.8	3	60	100	20
SBSF30100	2.8	3	100	140/150	20
SBSF30150	2.8	3	150	190/200	20
SBSF30175	2.8	3	175	215	20
SBSF3560	2.9	3.5	60	100	20
SBSF35100	2.9	3.5	100	140/150	20
SBSF35150	2.9	3.5	150	190/200	20
SBSF35175	2.9	3.5	175	215	20
SBSF4060	3	4	60	100	20
SBSF40100	3	4	100	140/150	20
SBSF40150	3	4	150	190/200	20
SBSF40175	3	4	175	215	20
SBSF4560	3	4.5	60	100	20
SBSF45100	3	4.5	100	140/150	20
SBSF45150	3	4.5	150	190/200	20
SBSF45175	3	4.5	175	215	20
SBSF5060	3	5.0	60	100	20
SBSF50100	3	5.0	100	140/150	20
SBSF50150	3	5.0	150	190/200	20
SBSF50175	3	5.0	175	215	20

## WALL STARTERS & MULTI-STARTERS

The quick, easy-to-fix way to tie-in new walls to existing walls without cutting out brickwork. Suitable for walls of up to 3 storeys high, i.e. up to 8m maximum.

**Wall Starters**  
Individual flanged products designed for specific widths of new walls.

**Multi-Starters**  
Featuring a 'turn-n-slide tie' to accommodate all sizes of brick or block.

The Multi-Starter is suitable for all wall widths from 60mm-250mm.



Wall Starters



Multi-Starters

### Need technical advice?

Call our expert team on 0330 404 9955 and they'll be pleased to help.



Visit [www.expamet.co.uk](http://www.expamet.co.uk) to view our bespoke windposts and masonry support services

Ref.	Description	Type	Wall Thickness
<b>Wall Starters</b>			
WS090	Stainless Steel	Single Flange Integral Tie	100-115mm
WS120	Stainless Steel	Single Flange Integral Tie	125-180mm
<b>Multi-Starters</b>			
MSSS/12	Stainless Steel	No Flange Turn-n-Slide Ties	Up to 250mm
MSGC/12	Plastisol Coated Galv	No Flange Turn-n-Slide Ties	Up to 250mm
MSGFIX	Plastisol Coated Galv	Extra Fixing Pack	
MSSFIX	Stainless Steel	Extra Fixing Pack	

## ACCESSORIES

### Scrolled Hip Irons

Designed to provide decorative restraint when bedding hip tiles.



Ref.	Material	Length x Width x Thick	Height
HIP2003	Galvanized Steel	200mm x 25mm x 3mm	100mm
HIP2503	Galvanized Steel	250mm x 25mm x 3mm	150mm
HIP3003	Galvanized Steel	300mm x 25mm x 3mm	150mm
HIP3004	Galvanized Steel	300mm x 25mm x 4mm	150mm

### Gallows Bracket

The Gallows Bracket provides a method of supporting otherwise unsupported brickwork.

Manufactured from 50 x 50 x 5 angle, red oxide finish.

Two sizes are available (supplied in pairs).

To suit M12 Masonry Anchors - not supplied.

MH375375  
375mm high x 375mm deep  
(projection from wall)

MH490375  
490mm high x 375mm deep  
(projection from wall)

### Stainless Steel Annular Ring Nails

SSRN 3.35 x 50mm  
1000 per box

Sherardised Nails  
SN32 BAT 3.75 x 30mm twisted  
1000 per box



## WINDPOSTS

### Windpost Types

Four types of BAT Windposts are manufactured in a range of section sizes and steel thicknesses to withstand applied wind loadings. Base and top fixing configurations can be specified to allow for varying methods of construction and loading requirements.

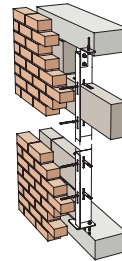

#### L Section

L Section Windposts are designed to minimise intrusion into the cavity. One leg of the post is built into the inner leaf blockwork and tied with wall ties to both leaves to minimise any possible movement of the structure.

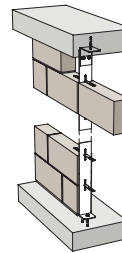

#### Spine Posts

Spine Posts are generally used for internal fair-faced walls. The post is a flat plate that can be built between blockwork panels and does not protrude beyond either finished face.

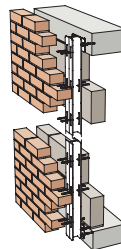

#### H Section

H Section Windposts serve the same purpose whilst allowing for heavy duty applications. Both U and H windposts leave the inner leaf of the cavity wall undisturbed.

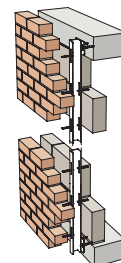

#### U Section

U Section Windposts fit within the wall cavity and normally span between floor structures.



Call our expert team on  
0330 404 9955 for more  
information

Expamet is one of the leading brands of specialist building products in the UK, Europe and the Middle East. Operating across two continents, we offer internationally recognisable products that are synonymous with quality, safety and innovation. Wherever you are and whatever your project, Expamet solutions are never far away.

---

## EXTENSIVE PRODUCT RANGE

Each of our great brands is committed to quality in its particular product field.

- **BAT** – Builders' metalwork products
- **Expamet** – Plasterers' accessories
- **Hy-Rib**<sup>®</sup> – Permanent formwork for concrete
- **Power-tie**<sup>™</sup> – Wall ties

---

## TECHNICAL AND SALES SUPPORT

Our comprehensive technical support service is designed to support your project all the way from specification to completion. Our expert technical and sales teams have extensive experience in the construction and engineering industries and are always on hand to offer advice on using our products to their full potential. Call us today on 0330 404 9955 to find out more.



Greatham Street, Longhill Industrial Estate (North)  
Hartlepool TS25 1PU United Kingdom  
Tel: Sales: 0330 404 9955  
E-mail: [expamet.sales@birtleygroup.co.uk](mailto:expamet.sales@birtleygroup.co.uk)  
Website: [www.expamet.co.uk](http://www.expamet.co.uk)

---

Quality assurance BS EN ISO 9001 and ISO 14001 2015 Registered Firms Certificate No. FM589272, EMS 589274



All products within the scope of regulation No. 305/2011 'The Construction Products Regulation' are CE marked in accordance with all relevant Harmonised Standards and ETA's. Declaration of performance documents can be found at [www.expamet.co.uk](http://www.expamet.co.uk)

Birtley Group operate a continuous development programme and reserve the right to amend specification without prior notification. Please note some products are not manufactured by Birtley Group and are therefore excluded from our registration to BS EN 9001: 2015. Please contact the technical department for further information.

All copyright, trade marks and unregistered design rights for the products detailed in this brochure are the property of Birtley Group Ltd.