

## INSULATION SOLUTIONS GUIDE - UK & IRELAND

Choose non-combustible, high performance, sustainable insulation solutions.



Thermal



Fire Safety



Acoustic



Sustainability



Energy saving

# CONTENTS

	Page Number
INTRODUCTION	Application product finder - 3 -
	The Knauf Group and Knauf Insulation - 4 -
	Insulation products to suit all your needs - 6 -
	For A Better World: A new vision of sustainability - 8 -
	Using insulation materials that minimise environmental impact - 10 -
	Overview of our partnership with Veolia - 12 -
	Summary of accreditations - 13 -
	Benefits of our insulation products - 14 -
	Thermal insulation for energy-efficient buildings - 16 -
	Non-combustible insulation for safer buildings - 18 -
	Acoustic insulation for quieter and healthier buildings - 20 -
	Insulation for maintaining a comfortable environment - 22 -
	ECOSE® Technology - The feel good factor - 24 -
	Why choose Knauf Insulation? - 26 -
	Expert advice and support to our customers - 28 -
Explore our online U-value calculator tool - 29 -	
A range of high performance products for all applications - 30 -	
APPLICATIONS	Roofs - 32 -
	Walls - 44 -
	Floors - 70 -
	Fire Protection - 80 -
PRODUCTS	Cured Glass Mineral Wool - 84 -
	Blown Glass Mineral Wool - 106 -
	Rock Mineral Wool - 114 -

# APPLICATION AND PRODUCT FINDER

	PAGE NUMBER	Roofs						Walls								Floors				Fire		Specialist	
		Pitched roof - ceiling level	Pitched roof - rafter level	Flat roof - warm roof	Flat roof - cold roof	Built-up metal roof	Green roof	External				Internal				Suspended timber ground floors	Exposed soffit floors	Separating floors	Internal floors	Ducts	Loft conversion floor		
								External masonry cavity walls	Timber frame walls	Rainscreen façade system	Frame construction with masonry outer	External wall insulation	Built-up metal walls	Separating (party) walls	Internal walls								
		32	34	36	38	40	42	44	50	56	58	60	62	64	68	70	72	74	79	80	81	82	
CURED GLASS MINERAL WOOL	Loft Rolls	84	✓																				
	FactoryClad Rolls	86				✓							✓										
	FrameTherm® Rolls	88		✓					✓														
	Rafter Roll 32	90		✓																			
	Acoustic Roll	92													✓			✓	✓				
	DriTherm® Cavity Slabs	94						✓															
	Masonry Party Wall Slab	96													✓								
	Timber Frame Party Wall Slab	98													✓								
	FrameTherm® Slab 32	100		✓						✓													
	OmniFit® Roll 34	102		✓							✓						✓						
	OmniFit® Roll 40	102	✓														✓		✓	✓			
	OmniFit® Slab 35	104		✓		✓				✓	✓	✓				✓	✓	✓	✓				
BLOWN GLASS MINERAL WOOL	Supafil® 34	106						✓															
	Supafil® 40	106						✓															
	Supafil® CarbonPlus	108						✓															
	Supafil® Party Wall	110												✓									
	Supafil® Frame	112							✓														
ROCK MINERAL WOOL	Rocksilk® RainScreen Slabs	114							✓	✓	✓												
	Rocksilk® Building Slabs	116		✓		✓			✓	✓					✓	✓		✓	✓				
	Rocksilk® Flexible Slab	118		✓					✓	✓					✓	✓		✓	✓		✓		
	Rocksilk® Acoustic Floor Slabs	120																✓					
	Rocksilk® Soffit Linerboards	122															✓						
	Rocksilk® Fabrication Slab	124																				✓	
	Rocksilk® Flat Roof Slabs	126			✓																		
	Rocksilk® EWI Slab	128											✓										
	Fire-tek Beam and Column Slab	130																				✓	
	Fire-tek BD 917 Slab	132																		✓			
	UrbanScape® Green Roof System	134						✓															

✓ Recommended products    ✓ Other suitable products



# KNAUF INSULATION & THE KNAUF GROUP



**With 40 years of experience in the insulation industry, we are leading the change in smarter insulation solutions for a better world.**

## Our mission

“Our mission is to **challenge** conventional thinking and **create** innovative insulation solutions that shape the way we live and build in the future, with **care** for the people who make them, the people who use them and the world we all depend on.”



We challenge ourselves, regulators and our industry to develop new concepts and new ways of thinking about insulation and buildings;

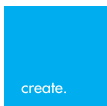

We create innovative solutions that change the way we work and set new standards of quality, performance and sustainability;

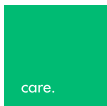

We care about what really matters: our people, our customers, our communities and ultimately, our planet.

## Our vision

“Our vision is to lead the change in smarter insulation solutions **for a better world**. Our aspiration is to be the world’s most trusted insulation partner providing high performing and smart insulation solutions and services for a better world.”





We are part of the Knauf Group, a family-owned multi-national manufacturer of building materials and construction systems.

Knauf Group



Knauf Insulation

2022 figures

€15.4 bn turnover



€2.5 bn turnover

+41,500 employees worldwide



+6000 employees worldwide

>300 plants & offices

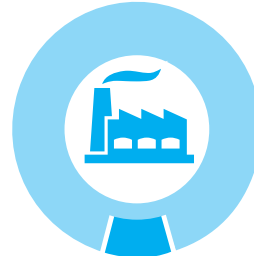

28 manufacturing sites

+90 countries



+15 countries

# KNAUFINSULATION

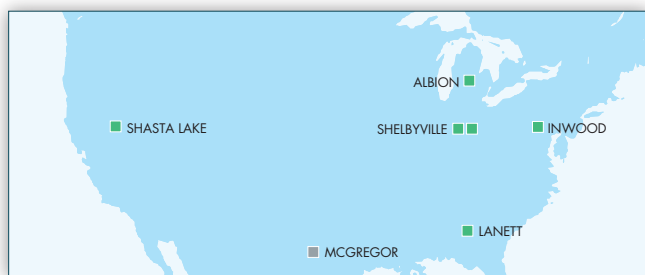

## MANUFACTURING FACILITIES

- MINERAL WOOL
- WOOD WOOL
- FABRICATION SHOP
- PLANNED FOR 2023

# INSULATION PRODUCTS TO SUIT ALL YOUR NEEDS

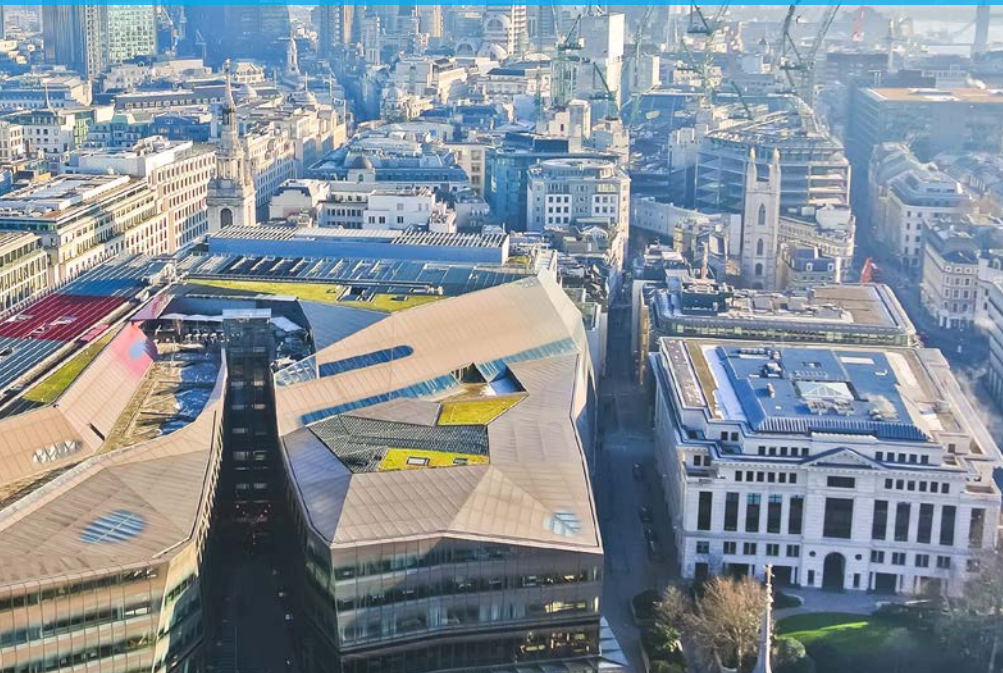

**We are committed to helping our customers meet the increasing demand for energy efficiency and sustainability in all buildings.**

As the only UK manufacturer of both Glass and Rock Mineral Wool, we are uniquely placed to provide the best insulation solution for each application. We offer a wide range of insulation solutions for all applications in commercial and residential buildings, for both new build and refurbishment projects, in addition to solutions for HVAC, industrial applications and fire protection, green roofs and bespoke applications.

We offer a wide range of high performance, non-combustible insulation solutions for all buildings.

Our extensive product range is designed to provide solutions for all types of roofs, walls and floors, as well as specialist fire protection.



COMMERCIAL

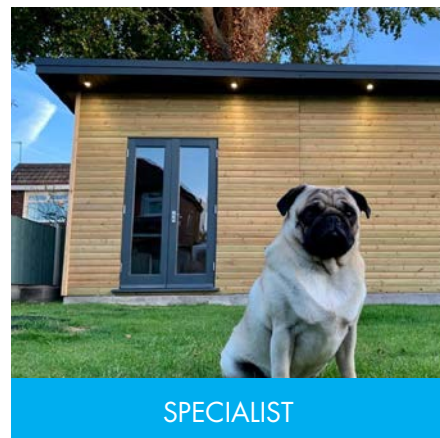

SPECIALIST

**View our range of case studies on our website:**

**[knaufinsulation.co.uk/  
media/case-studies](https://www.knaufinsulation.co.uk/media/case-studies)**



HOUSING

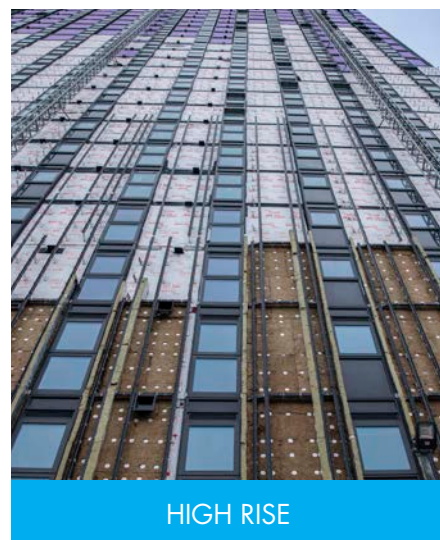

HIGH RISE





### Offsite

Our offsite solutions include a wide variety of products suitable for both panellised and volumetric construction.

Understanding that every system is tailor-made, we can work with you to recommend the best insulation solution for your system.

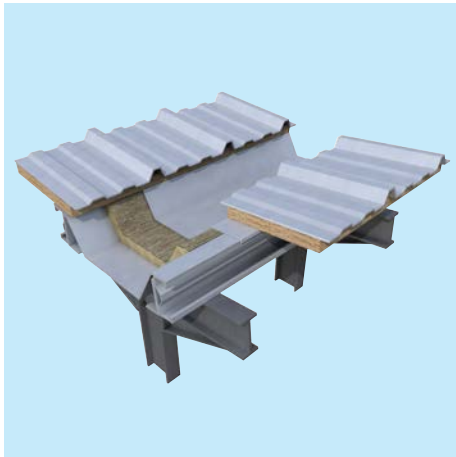

### Bespoke applications

Our UK Special Products team is on hand to help develop bespoke products or systems that will add value to your business and help you stand out from the competition.

By having a fully customisable product specification, we promise to make our products work as best they can for you.



### Technical applications

Our Technical Solutions comprise of a range of high performance insulation solutions developed specifically for the insulation requirements of HVAC systems and industrial plants. Our range covers solutions for insulating heating systems, piping and air conditioning ducts, insulating industrial plant and power stations, and for passive fire protection.



### Green roof, landscaping and horticultural applications

We have a range of green roof, landscaping and horticultural solutions. Our Urbanscape® Green Roof System is an innovative, lightweight easy to install system and is the world's first green roof system with a Life Cycle Assessment (LCA) and Environmental Product Declaration (EPD).



# FOR A BETTER WORLD

## A NEW VISION OF SUSTAINABILITY

At Knauf Insulation, sustainability is at the heart of everything we do.

Our products save energy, cut emissions, and are designed to make sure buildings are good for the environment.

Over the past decade, we have focused on zero harm, reducing our energy use and emissions, recycling our production waste, incorporating circular economy principles and constantly campaigning for better and more sustainable buildings.

We have achieved great things around sustainability so far and we are proud of how we have changed our company, helped our colleagues, communities and customers by reducing our impact on the environment.

Sustainability is a process of continuous improvement. We need to build on our successes. We must do more for our people and our environment. That is why we've created our new sustainability strategy.

'FOR A BETTER WORLD' builds on the success of our mission statement:  
"Our vision is to lead the change in smarter insulation solutions for a better world."

The strategy reveals our future ambitions and focuses on four key sustainable goals:



**PUT  
PEOPLE  
FIRST**

We will ensure our communities and people thrive, safely.



**ACHIEVE  
ZERO  
CARBON**

We will minimise the impact of our products, plants and offices.



**DELIVER A  
CIRCULAR  
ECONOMY**

We will do more with less.



**CREATE  
BETTER  
BUILDINGS**

We will help make buildings fit for the future.



We are supporting our customers as they navigate an ever-changing landscape of demanding green building requirements and increasingly stringent environmental regulation. We have the experience and expertise to support our customers to achieve their sustainable ambitions.

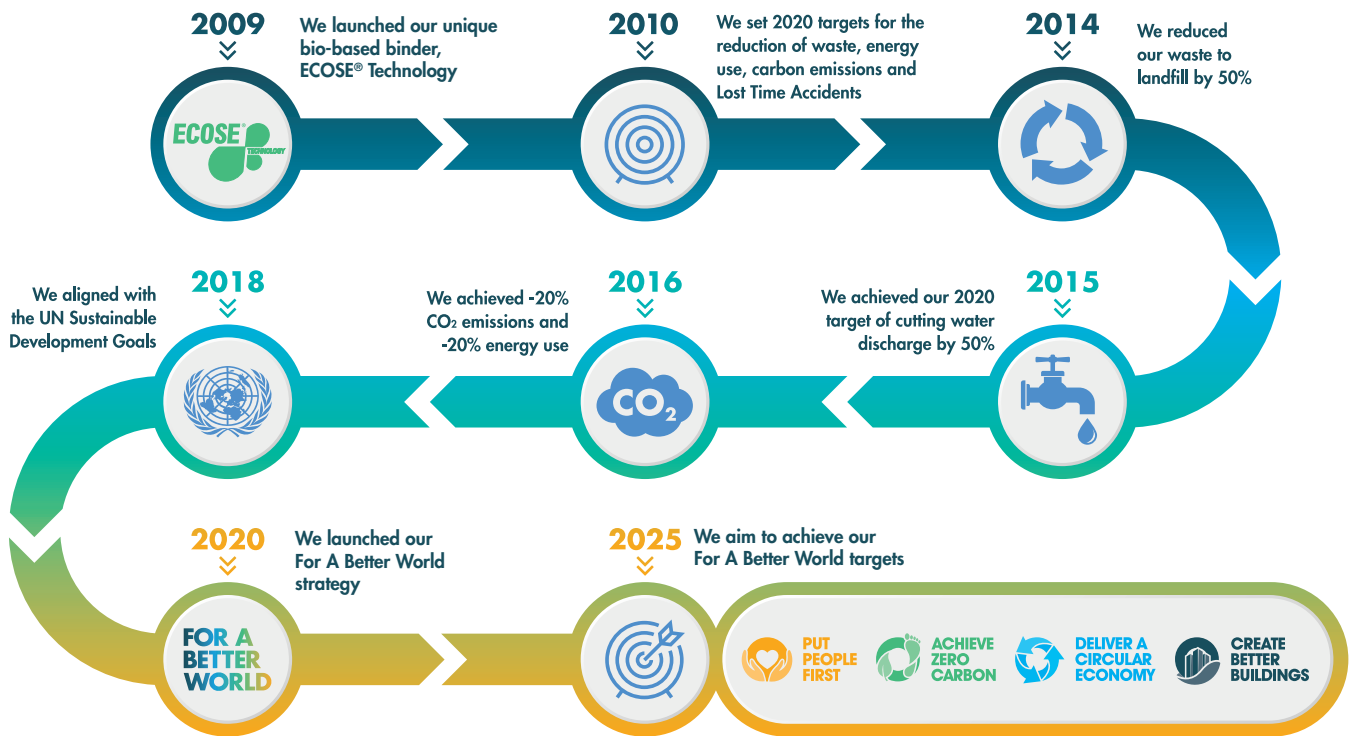

## OUR SUSTAINABILITY JOURNEY

We believe sustainability success is a process of continuous improvement. Since we started our journey we have consistently worked to reduce our environmental impact and recorded significant achievements (see below). Our new sustainability strategy builds on the success of the past decade.

### OUR 2010 TO 2020 HIGHLIGHTS

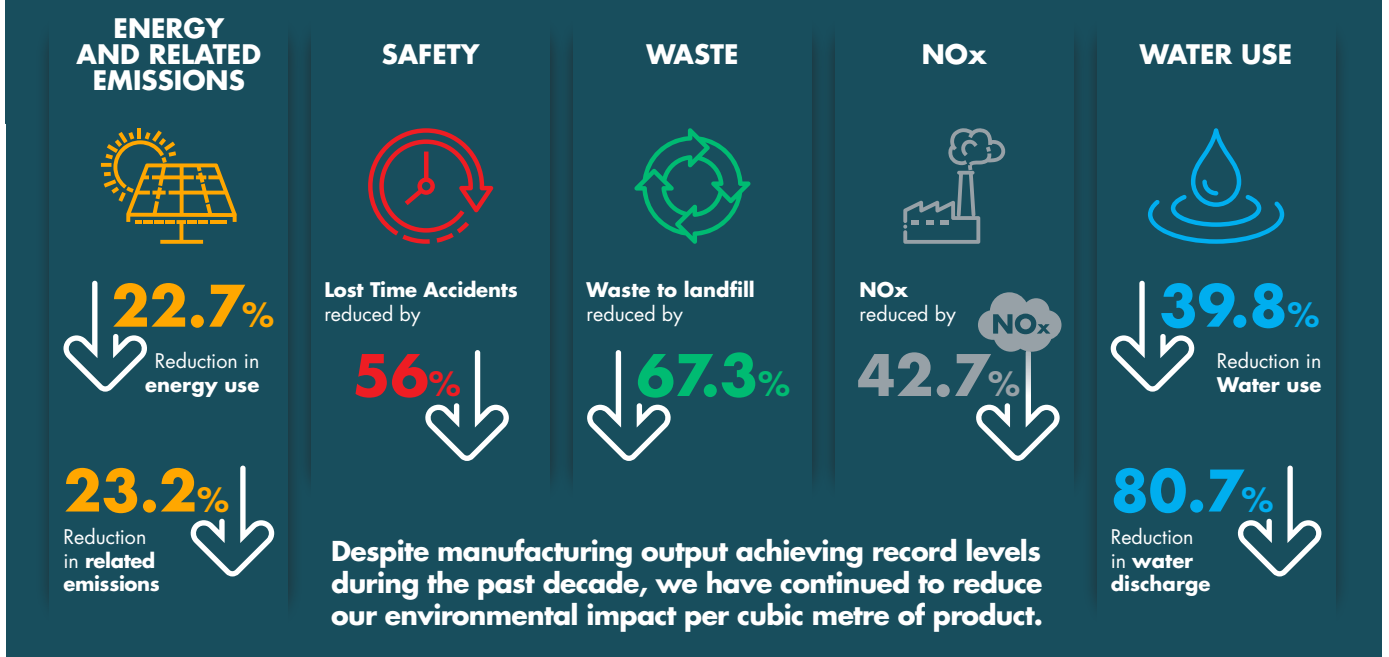

# USE INSULATION MATERIALS THAT MINIMISE ENVIRONMENTAL IMPACT

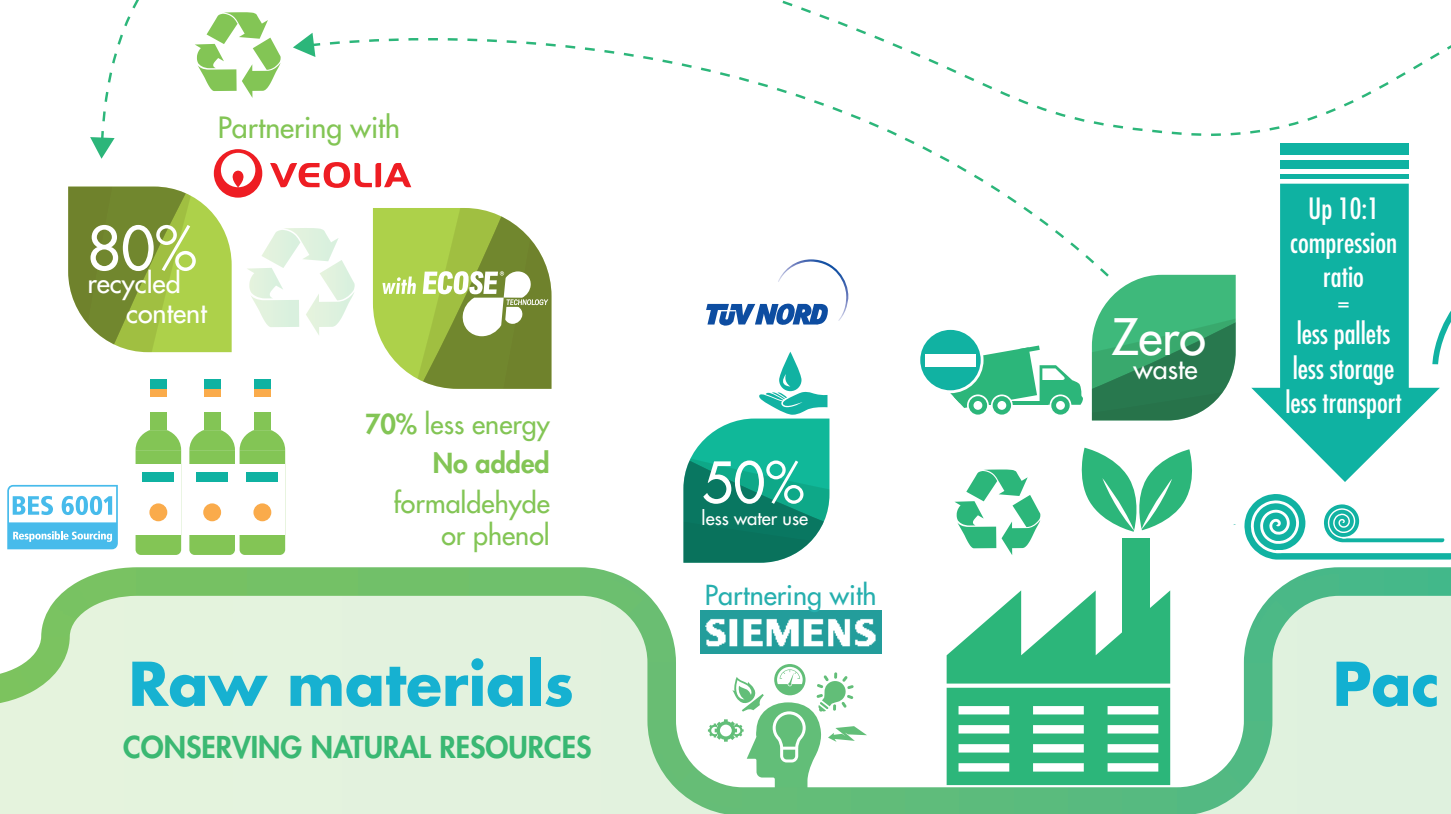

**Our Glass Mineral Wool insulation solutions** contain up to 80% recycled content. By maximising the amount of recycled glass in the manufacture of our products, we minimise our need for virgin raw materials.

**Our unique bio-based binder, ECOSE® Technology** contains no added formaldehyde or phenol. It is made from natural raw materials that are rapidly renewable and is 70% less energy-intensive to manufacture than traditional binders, so it is more environmentally-friendly.

**Our work to ensure safe and legal operations in our supply chain** has enabled us to achieve certification to the Building Research Establishment's responsible sourcing standard BES 6001.

**Partnering with Siemens**, we are unlocking efficiency opportunities to reduce our carbon footprint, saving the equivalent annual energy usage of almost 800 homes.

**Our commitment to fair and safe working practices** in our own facilities is embedded in our code of conduct, and reflected in the ISO 45001 certification covering all our production sites.

All our facilities are also certified to ISO 14001 and ISO 50001 standards.

**We avoid waste and prevent pollution;** we segregate factory waste to maximise recycling and to meet our expectation of sending zero waste to landfill from our UK plants.



As the market leader and a non-stop innovator, quality excellence and sustainability are at the heart of everything we do. Whilst we have a strong focus on the thermal, fire safety and acoustic performance of our products, our pursuit of sustainability has much wider horizons.

We are dedicated to supplying sustainable high performance insulation solutions for enhanced energy efficiency in buildings, but we also continually strive for improvements in our manufacturing and supply chain operations to improve quality and minimise our impact on the environment. All our production locations have state-of-the-art manufacturing equipment and meet the highest quality standards, supported by an ongoing research and development program.

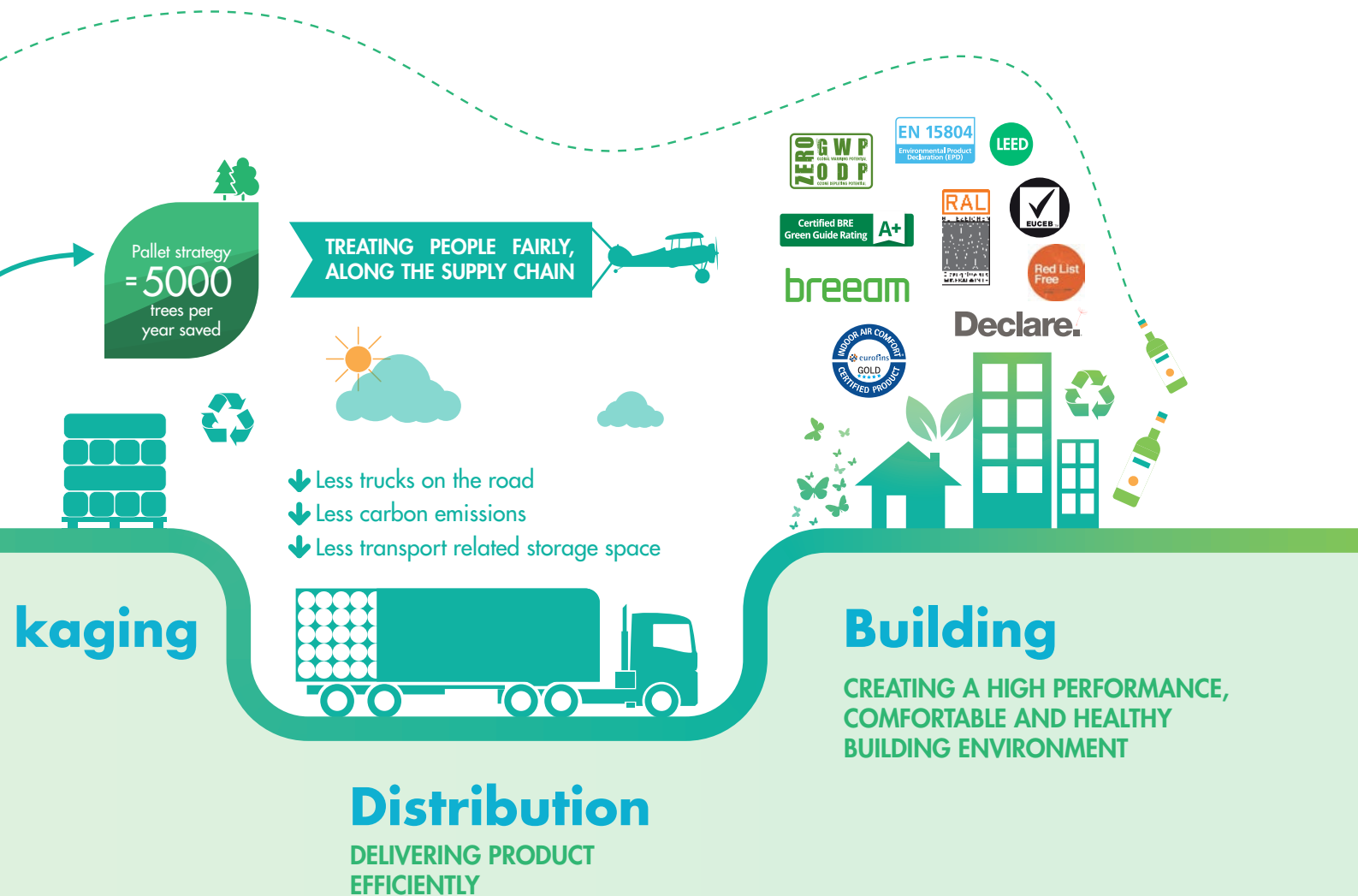

### Packaging 'For A Better World'

We have recently improved our industry-leading compression-packaging, and have been able to further increase the amount of material per pack or pallet for our Glass Mineral Wool products.

This means even fewer trucks on the road, less storage and handling for our customers. In addition, we have re-designed our packaging to be more customer-centric, while reducing the amount of ink by up to 50%.

We are also introducing a new packaging film with a minimum of 30% recycled plastic content. This means the plastic we do use is even easier to recycle and reduces our carbon footprint.

**Over the years, we have been trimming the weight of the pallets we use in the UK, cutting around 2kg per pallet, equating to a total saving of around 5,000 trees/year.**

### Our products contain very low levels of VOCs

which affect indoor air quality, attested by their certification to Eurofins Gold Certificate for Indoor Air Comfort.

**The overall environmental performance** of our products is reported in Environmental Product Declarations. They are verified by an independent third-party and comply with the European standard EN 15804.

### Our Glass Mineral Wool and Blowing Wool products

are registered in the BRE's UK-specific Certified Environmental Profiles scheme. The majority of our products have a generic Green Guide rating of A+.

**Our entire Glass Mineral Wool product range has been awarded the DECLARE 'Red List Free' label.**

This allows product transparency disclosure that identifies where a product comes from and what it is made of.

# MINIMISING THE USE OF VIRGIN RAW MATERIAL IN PARTNERSHIP WITH VEOLIA

**Our high performance Glass Mineral Wool insulation contains up to 80% recycled content, most of which is glass cullet from Veolia's glass recycling facility next to our manufacturing plant in St. Helens, Merseyside.**

By maximising the amount of recycled glass cullet in the manufacture of our products, we minimise our need for mineral raw materials.

The partnership with Veolia brings many benefits:

- It provides an assurance of supply of raw materials and we are able to maintain the recycled materials content in the manufacture of our Glass Mineral Wool insulation solutions up to 80%.
- It has reduced waste going to landfill and over 60,000 tonnes of used glass bottles and jars are given a new lease of life each year.
- The partnership has provided a closed loop solution and a significant investment in the mainstream circular economy.
- The proximity of the facility saves approximately 375,000 miles of road journeys every year.





# OUR ACCREDITATIONS

We're proud to have gained a number of accreditations and be able to provide our customers the assurance that our products are manufactured to the highest level of quality, having passed a series of comprehensive and rigorous assessments which ensures they're fit for purpose.



**Euroclass reaction to fire classification**  
All of our products are non-combustible and achieve the best Euroclass A1 or A2-s1,d0 reaction to fire classification.



**BBA Certification**  
The British Board of Agreement offers third party certification for the use of building products and systems in critical applications. We have a number of products certified, and are always seeking to increase our portfolio.



**BES 6001**  
The BES6001 accreditation shows that our products have been made with constituent materials that have been responsibly sourced.



**ISO**  
All of our manufacturing plants are certified to ISO standards.



**BRE Green Guide Rating A+**  
We have received the BRE Green Guide Rating A+ for the best environmental performance for the majority of our products.



**EUCEB**  
An independent certification authority that guarantees our Mineral Wool products are made of certified bio-soluble fibres.



**CE Marking**  
All our products are CE marked where required.



**RAL**  
A German quality mark confirming Knauf Insulation's Rock Mineral Wool products (including those made in the UK) are made of certified bio-soluble fibres and can be safely used for thermal and acoustic purposes.



**UKCA Marking**  
All our products are UKCA marked where required.



**DECLARE 'Red List' Free**  
Our entire Glass Mineral Wool range of products has been awarded the DECLARE 'Red List Free' label. This allows product transparency disclosure that identifies where a product comes from and what it is made of.



**Eurofins Indoor Air Comfort Gold Certified**  
The Eurofins Gold certification for Indoor Air Comfort means our Glass and Rock Mineral Wool products are the best-in-class low VOC emissions and are therefore the ideal solution for indoor air quality.



**Made in Britain**  
As a member of the Made in Britain organisation, it helps customers identify that our Mineral Wool products are manufactured in the UK.



**EN 15804**  
Our Environmental Product Declarations (EPD) are in line with the BRE and European standard EN 15804.

# MINERAL WOOL INSULATION PROVIDES A UNIQUE COMBINATION OF BENEFITS



## THERMAL

**The energy saving properties and thermal performance of insulation keep buildings warm in winter and cool in summer.**

The bigger the temperature difference between the inside and outside of a building, the faster the building will lose heat in winter and gain heat in summer.

Our mineral wool insulation solutions help maintain a stable inside temperature by slowing heat transfer by convection, conduction and radiation.

By insulating a property properly, energy can be saved either from the heating system when heating a cold building, or from the air conditioning system when cooling a warm building.



## FIRE SAFETY

**The fire performance of our insulation gives it the ability to provide passive fire protection.**

Buildings must be designed and constructed to minimise the risk of fire and its spread should it occur, as well as to maximise the structure's stability and the ability of occupants to escape unharmed.

As well as acting as a barrier to the fire, our non-combustible mineral wool insulation solutions will not add to its development stages, minimising its overall effect and consequences.



It is widely known that buildings account for 40% of worldwide carbon emissions, and increasing their energy efficiency continues to be a priority for governments as they try to combat climate change. Whilst the primary role of insulation is to provide thermal performance, choosing the right insulation will also determine a building's acoustic and fire safety properties as well as the level of comfort it provides for its users. Our mineral wool insulation solutions provide a **unique combination of performance**.



## ACOUSTIC

**The acoustic performance of insulation can help create an improved internal environment for building occupants.**

Protection from noise contributes towards the 'quality of life' afforded by dwellings, and a healthy, productive and attractive environment in offices, hospitals, schools and other non-domestic buildings.

Our mineral wool insulation solutions provide high levels of sound absorption and noise reduction in new build or within existing buildings through retrofit, to provide improved sound insulation and acoustic comfort.



## COMFORT

**Insulation can help create dry, comfortable indoor environments and buildings and have a major impact on the health and wellbeing of their users.**

By preventing air leaks, uncontrolled condensation and possible mould spores, mildew or microbial organic compounds, a well-insulated, airtight building envelope also contributes to the health of a building — particularly if combined with efficient installation of the solutions and a controlled ventilation system.

Our mineral wool insulation solutions provide all of the above benefits, but more importantly, thanks to our ECOSE® Technology, they contribute to high levels of indoor air quality and were the world's first products to be awarded the Eurofins Gold Certificate for Indoor Air Comfort.





# THERMAL INSULATION FOR ENERGY-EFFICIENT BUILDINGS

## THE ENERGY SAVING PROPERTIES OF INSULATION KEEP BUILDINGS WARM IN WINTER AND COOL IN SUMMER

The bigger the temperature difference between the inside and outside of a building, the faster the building will lose heat in winter and gain heat in summer. Insulation helps maintain a stable inside temperature by slowing heat transfer by convection, conduction and radiation.

## INSULATION IS CRITICAL ACROSS ALL SECTORS

A vast amount of energy is lost through the fabric of a building. Insulation incorporated into fabric can make a profound contribution to the building's long-term energy saving.

Increasingly, designers have the responsibility to improve a building's energy efficiency by designing an envelope to best achieve maximum thermal performance according to the building's function and activity. Different sectors have different requirements - for example, balancing heat retention and cooling in public and commercial buildings is often a key consideration, whereas for residential buildings, higher insulation and heat retention alone have a direct impact on the carbon emissions (and bills) associated with heating, and is the overriding design parameter.

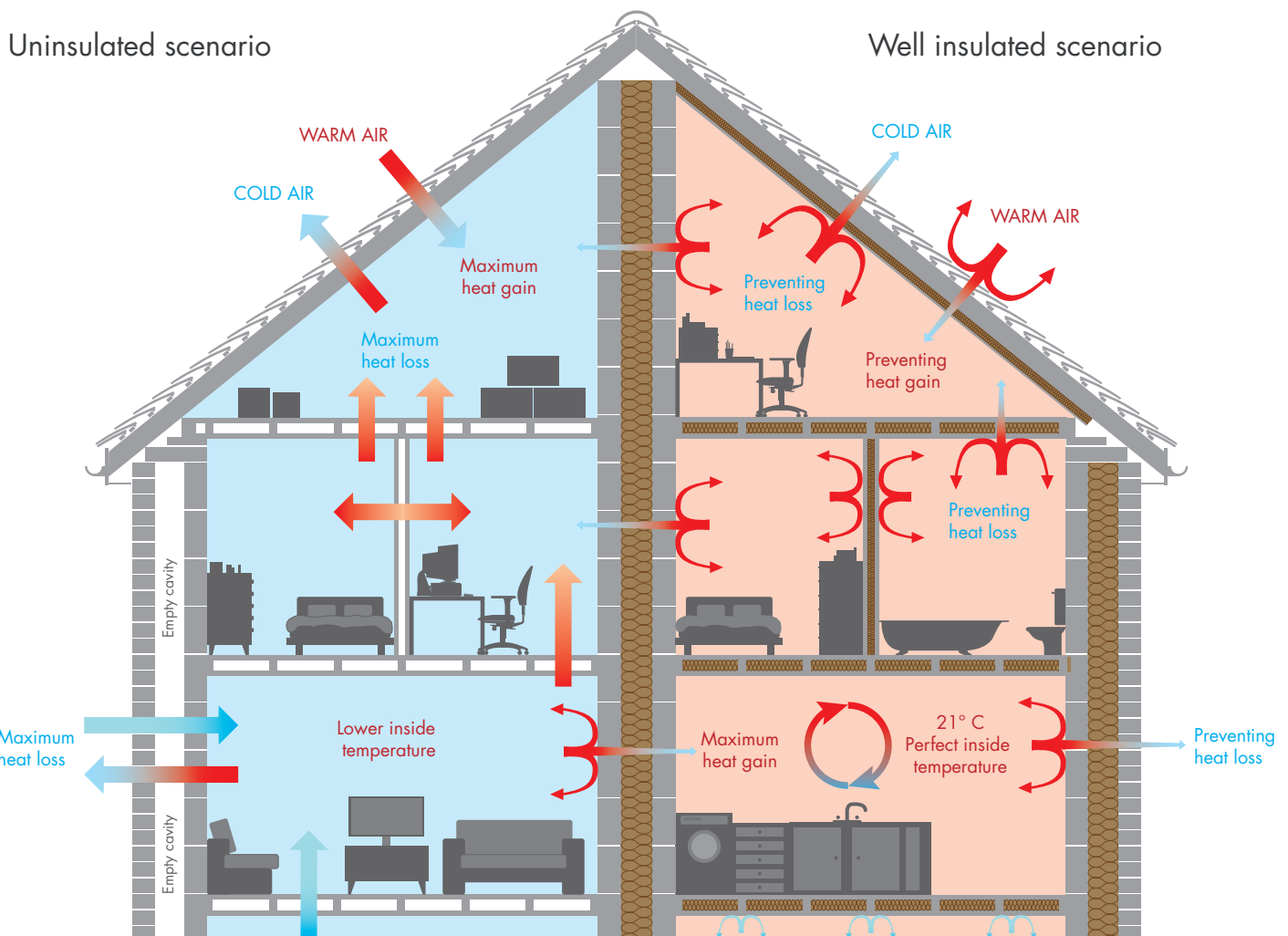

## HOW MINERAL WOOL PROVIDES PROVEN REAL ENERGY EFFICIENCY PERFORMANCE

Mineral Wool insulation is a poor conductor of heat, meaning that warm or cold air won't transfer through the material resulting in a consistent temperature inside the building. It does this by having a spider's web type structure inside of the material with millions of small air pockets that catch any heat or noise transfer from external sources, making it one of the most efficient ways of insulating any property.

It is also easier to install as the fibrous structure of the material fills the space; meaning that any imperfections in installation are negated and therefore gives a better real performance.

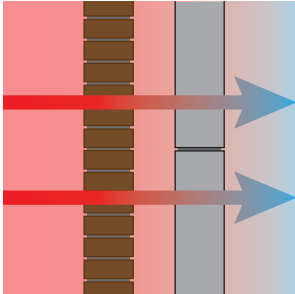

### Conduction

Conduction is the transmission of heat through a material, or from one material to another, through direct contact, and can take place in solids, liquids and gases.

#### How conduction is reduced

To reduce heat transfer by conduction, Mineral Wool has a very small amount of solid material in relation to void.

Additionally, the solid material consists of thin connecting walls, or discontinuous fibres.

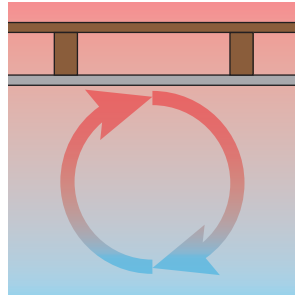

### Convection

Convection occurs in gases and liquids. If a hot surface is in contact with cooler air, heat is conducted to the air. This air then becomes warmer and therefore less dense than the adjacent cooler air. The warmer, lighter air rises upwards and is replaced by cooler air, causing a continuous flow of air by natural convection – gradually removing heat from the hot surface to the air. The process is reversed if warm air comes into contact with a cold surface.

#### How convection is reduced

To reduce heat transfer by convection, Mineral Wool contains small voids and air pockets within which air movement is minimised.

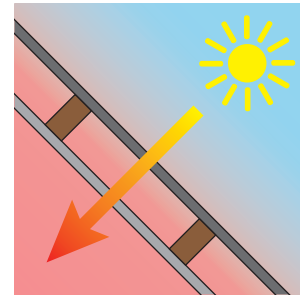

### Radiation

Radiation is the transmission of infra-red radiant energy from a 'hot' surface to a 'cold' surface through air or a vacuum. Radiant energy moves through space without heating anything in between – the energy is only absorbed when its path is blocked by an object which absorbs the energy and converts it to heat.

#### How radiation is reduced

The transmission of heat by radiation is stopped when it is absorbed into the surface of a material such as Mineral Wool, which results in a rise in temperature of the material. However that material will in turn emit radiant energy. For higher levels of resistance to radiated heat loss, "low emissivity" surfaces (e.g. metallic foil faced finish) can be added to our products.

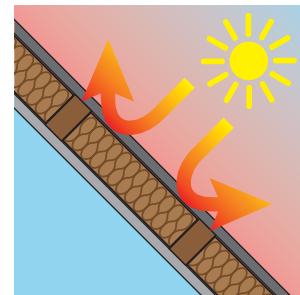
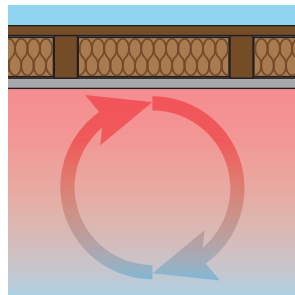
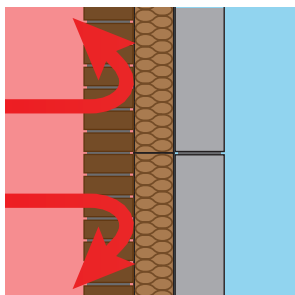



# NON-COMBUSTIBLE INSULATION FOR SAFER BUILDINGS



## **Reaction to Fire and Fire Resistance are two different, but very important considerations when it comes to designing a building.**

Our non-combustible mineral wool insulation solutions offer the best performance when it comes to both Reaction to Fire and Fire Resistance, enabling building designers and specifiers to develop effective and robust fire safety strategies when they design new buildings.

**REACTION TO FIRE** - How quickly will the fire develop?

The measurement of how a material or system will contribute to the fire development and spread, particularly in the very early stages of a fire when evacuation is crucial.

All insulation materials are given a Euroclass reaction to fire classification in accordance with BS EN 13501: *Fire Classification of construction products and building elements*, helping specifiers to understand how much 'fuel' will be added to the building as well as how a material will contribute to the development stages of a fire when evacuation is crucial.

Testing is carried out to determine the performance of materials in terms of fire behaviour, smoke production and flaming droplets, giving a range of classification possibilities as shown over the page.

Our entire range of Mineral Wool products are non-combustible.

**By choosing non-combustible insulation materials, building designers and specifiers can design out the risk of fire within the building fabric from the start.**

**FIRE RESISTANCE** - How long can the construction withstand the fire?

The measurement of the ability of a material or system to resist, and ideally prevent, the passage of fire from one distinct area to another.

Building regulations require certain elements such as partitions, separating walls, ceilings and beam and column constructions to provide specified amounts of fire resistance.

Fire protection classifications are normally reported in terms of a period of fire resistance, for example 30, 60 or 90 minutes. These classifications relate to what is known as the integrity (E), thermal insulation (I) and load-bearing capacity (R) of building elements. Simply, this means how elements — either in combination or individually — stop a fire spreading, how they restrict temperature rise and how the elements' load-bearing capacity is maintained.

A range of our solutions have been tested for use in a variety of fire-resistant applications, providing fire resistance periods ranging from 30 to 240 minutes to assist the design of safe buildings.

**Our non-combustible fire-resistant solutions help inhibit fire spread, maintain structural integrity and limit the spread of fire and smoke from one area to another, providing safe buildings for occupants, and added peace of mind for specifiers.**

## TYPICAL INSULATION PRODUCT EUROCLASS REACTION TO FIRE CLASSIFICATIONS

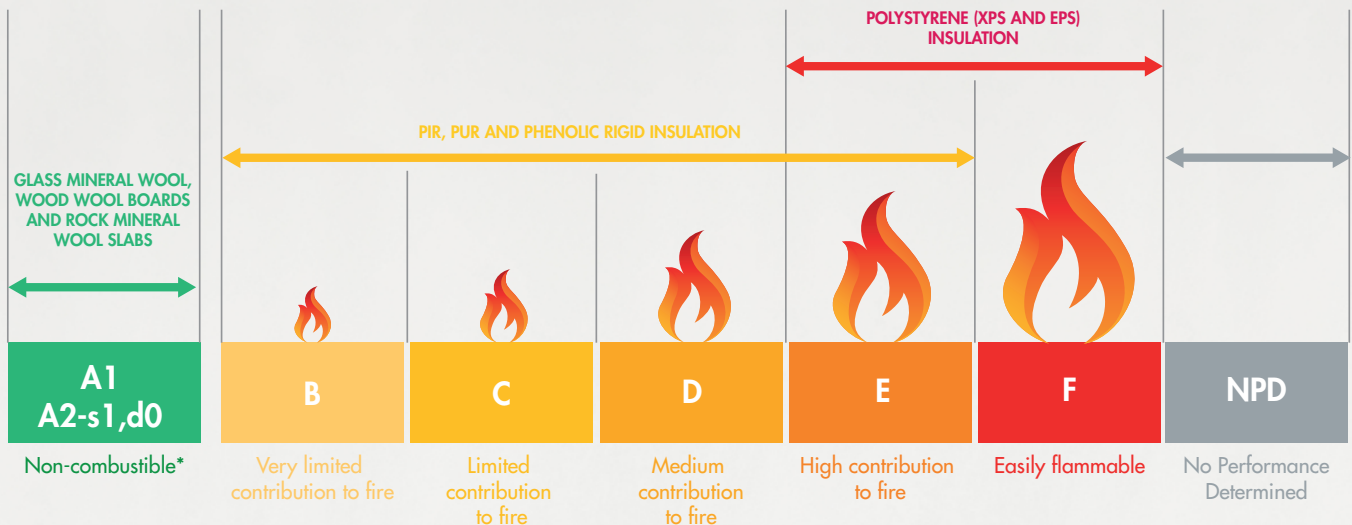

\*As set out in changes to the Building Regulations 2010 which bans the use of combustible materials, limiting the use of materials to those that achieve A1 or A2-s1,d0 on buildings in scope of the ban (as defined in regulation 7(4))

Notes: Other classifications of smoke and flaming droplets within A2 are classed as limited combustibility. (Not shown here as no insulant falls in that category).  
Flames are illustrative only.

### AVAILABLE INSULATION CPD COURSE

## MINIMISING FIRE RISK THROUGH MATERIAL CHOICE: Understanding the Euroclass reaction to fire classification system to enhance fire safety.

- The difference between Reaction to Fire and Fire Resistance
- The importance of the Euroclass reaction to fire classification system
- How insulation products are tested and classified
- Minimising risk through material choice

Visit [knaufinsulation.co.uk/technical-support/cpd](http://knaufinsulation.co.uk/technical-support/cpd)  
to book your CPD today!



# ACOUSTIC INSULATION FOR QUIETER AND HEALTHIER BUILDINGS

**Our Glass and Rock Mineral Wool solutions achieve the highest standards for sound absorption, so whatever your application, there's a Knauf Insulation product for it.**

Noise pollution costs Europe €24Bn per year in lost productivity, health costs and impaired learning <sup>[1]</sup>. That's why we need better buildings designed with acoustics in mind.

But there's a strong case to go beyond minimum regulatory levels.

Our Mineral Wool insulation solutions are excellent at absorbing sound, creating homes, offices, schools and hospitals that are quieter, healthier and more productive.

<sup>[1]</sup> <https://blog.ted.com/9-ways-that-sound-affects-our-health-wellbeing-and-productivity/>

## WHY REDUCING NOISE IS IMPORTANT

Sound can affect us in a variety of ways. In our everyday lives, we value those things that protect our health in noisy workplaces, promote the amenity values of our homes and outdoor spaces, and maintain our privacy in offices and consulting rooms. These and many other aspects of our lives rely on the appropriate consideration of how noise is controlled, in our ever-busier world.

## THE BASICS OF ACOUSTICS

The term 'acoustics' encompasses the combination of complex factors which affect the generation, propagation and perception of sound in the environment. Sound is a sensation detected by the ear as a result of pressure variations set up in the air by a vibrating source.

Our ability to detect a sound varies depending on its frequency composition, with a young and healthy human ear being able to detect sounds between the frequencies of approximately 20 Hz and 20 kHz. Our ability to accurately detect individual frequencies within that range varies due to the physical anatomy of the ear, and can be further reduced by damage through noise exposure or can be reduced over time.

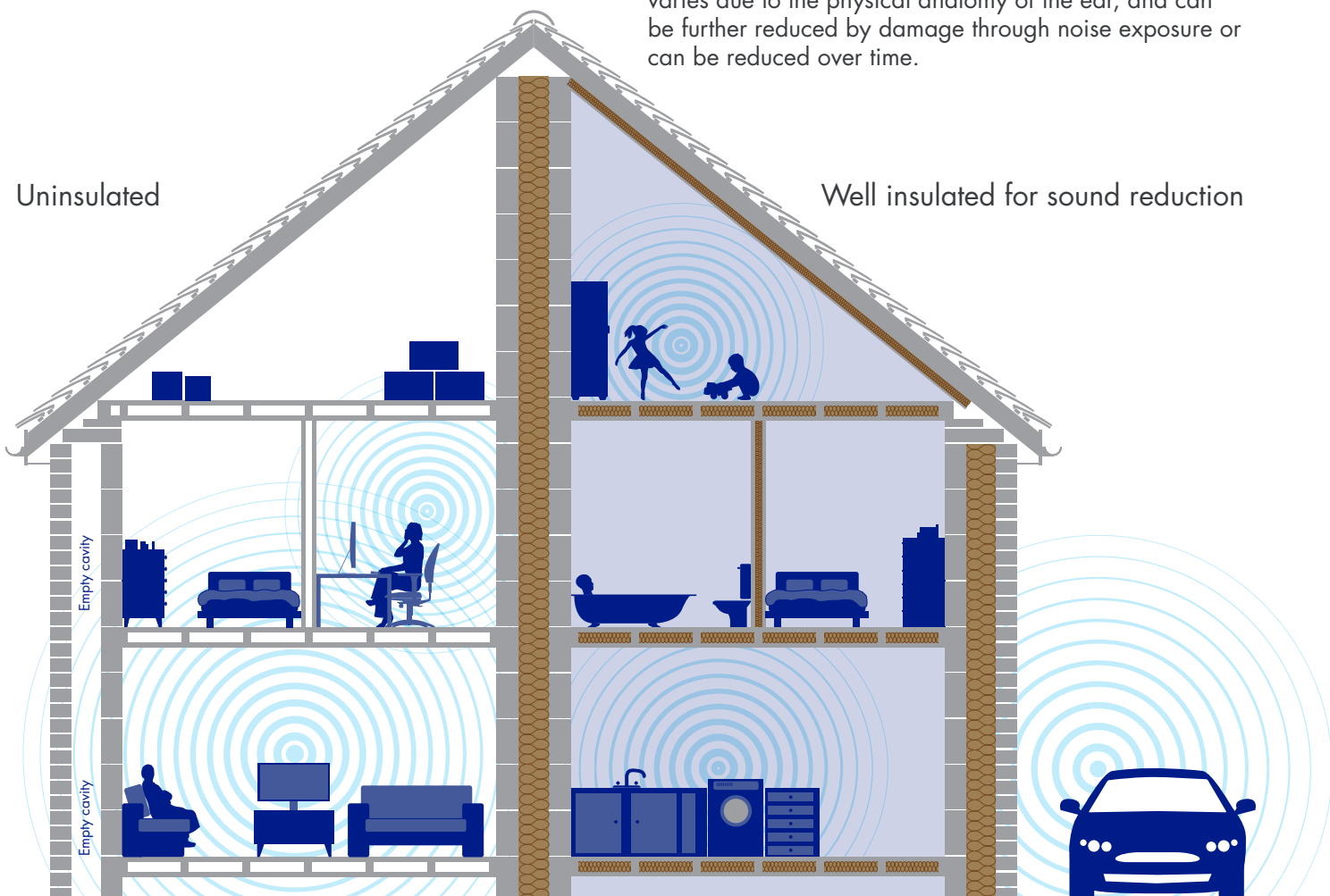

## THE DIFFERENCE BETWEEN SOUND INSULATION AND SOUND ABSORPTION

Sound insulation is the ability of a material to prevent the transmission of sound energy through it. The sound insulation performance of a construction element is critical when considering the ingress of noise from outside to inside via the building envelope or from one room to another through an internal or separating wall or floor. Typically, the higher the mass of a material, the better its sound insulation properties.

Sound absorption describes the ability of a material to prevent sound energy from reflecting from its surface. Sound energy is absorbed by a material by converting to heat energy; generally speaking, materials that are 'soft' are better sound absorbers than materials that are rigid and 'hard'. Sound absorbing materials are often used to treat walls or ceilings to prevent unwanted echoes (reverberation) within large spaces.

## USING ABSORPTION FOR NOISE REDUCTION

Glass and Rock Mineral Wool insulation products have excellent acoustic absorption performance. The use of these materials in carefully specified constructions with good detailing can contribute significantly towards the requirements stipulated in building regulations.

The presence of a sound absorbing material such as Mineral Wool within the cavity can improve the overall sound insulation rating of a double leaf partition by as much as 10 dB compared with an empty cavity.

## INTRODUCING SEPARATION FOR ENHANCED PERFORMANCE

Introducing separation in combination with absorption can achieve much larger improvements in sound insulation. Leaves must be independent i.e. there should be no physical connections between the two leaves of the construction.

When introducing separation, a cavity of at least 50mm wide prevents 'mass-air-mass resonance', whereby the air between the two leaves acts as a spring and transmits sound energy at a specific frequency through the partition. This resonant frequency is dependent upon the mass of the leaves and the cavity depth. The cavity should also contain a sound absorbing material to prevent the build-up of reverberant sound.

## Want to find the right product for your application?

Use our Noise Reduction Insulation Product Finder by visiting

[knaufinsulation.co.uk/acoustics](https://knaufinsulation.co.uk/acoustics)

Simply select the details of your project - the tool will tell you which sound insulation regulations apply and which products to use to achieve the acoustic performance you require.

AVAILABLE INSULATION CPD COURSE

## SOUND INSULATION PRINCIPLES FOR BETTER BUILDING ACOUSTICS:

Science, standards and solutions:

- How sound insulation is measured
- Various solutions to improve sound insulation performance
- How sound absorbent Mineral Wool contributes towards high levels of sound insulation

Visit [knaufinsulation.co.uk/technical-support/cpd](https://knaufinsulation.co.uk/technical-support/cpd) to book your CPD today!



# INSULATION FOR MAINTAINING A COMFORTABLE ENVIRONMENT

## Indoor air quality is moving up the agenda and VOCs are in the spotlight.

The government's Clean Air Strategy 2019 seeks to address poor indoor air quality by reducing emission sources of VOCs and improving building ventilation. Public England's Indoor Air Quality guidelines identify reducing indoor-generated formaldehyde as of the greatest importance due to its prevalence and known health impacts.

### WHAT ARE VOCs?

Volatile Organic Compounds (VOCs) are chemicals that evaporate at room temperature, becoming vapours or gases.

Common sources of VOCs include domestic cleaning products, furnishings, office printers and building materials e.g. paint, insulation etc. Many different chemicals are classed as VOCs, but one of the most common in building materials is formaldehyde, which is classed as a VVOC (Very Volatile Organic Compound).

### WHY ARE VOCs IMPORTANT?

VOCs are one of the main causes of poor indoor air quality, particularly as buildings become more airtight.

VOCs and indoor air pollution can have long-term consequences on the health of installers and later the building occupiers – for example, skin and eye irritation, nausea, headaches and asthma.

### HOW TO LIMIT VOCs

The construction sector is under pressure to reduce sources of VOCs in buildings.

NICE (National Institute of Health & Care) guidelines recommend architects, builders, developers and landlords favour materials that only emit low levels of VOCs and formaldehyde.

The British Lung Foundation recommends using building materials with low VOC emissions.

We have already seen the impact of this on the paint industry – regulation changes have resulted in the development of low VOC paints, which are increasingly popular with consumers. This means VOC emissions are now an essential consideration in deciding which products to stock, specify and install to reduce the risk of being left behind by changing building regulations and customer demand.

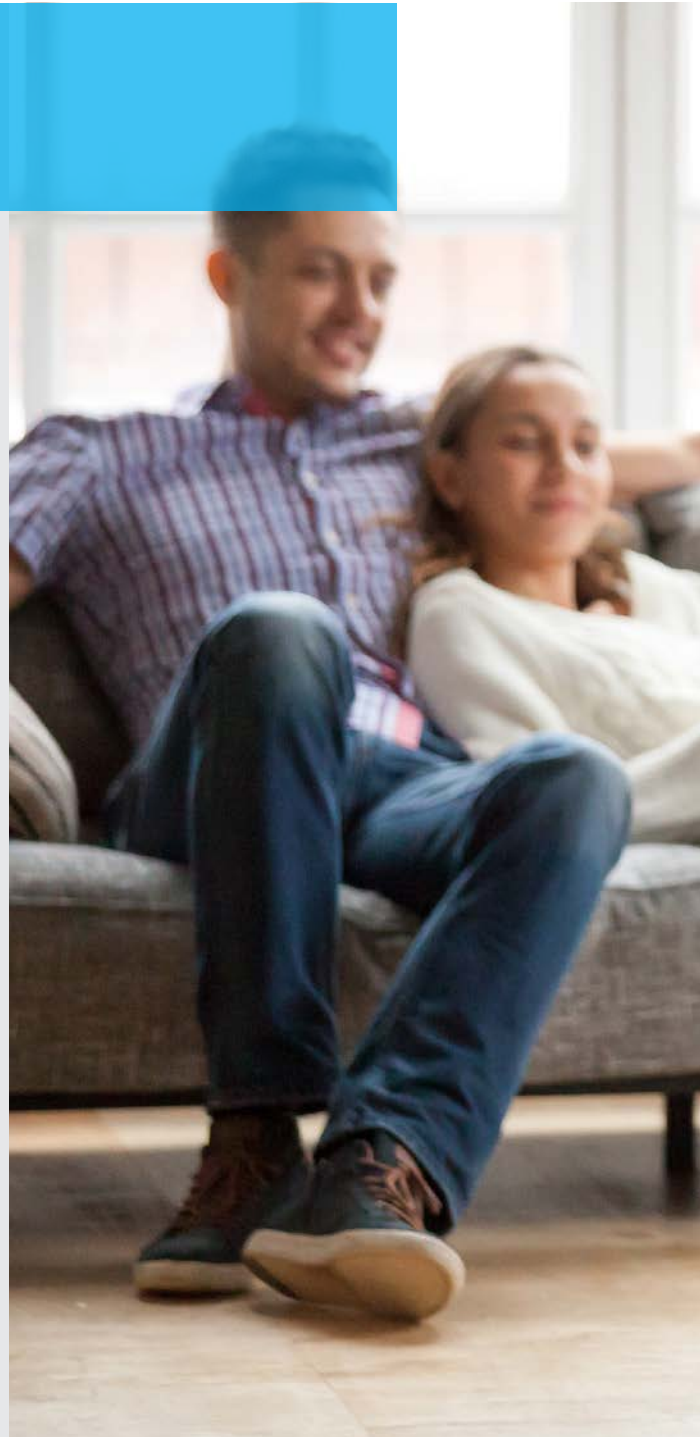



### HOW TO CHOOSE INSULATION WITH LOW VOCS

The best way to be sure that a product does not compromise indoor air quality is to look for independent certification by Eurofins. Products that meet the highest standards for VOC emissions are certified 'Indoor Air Comfort GOLD' by Eurofins.

All of our Blown Glass Mineral Wool products and cured Glass and Rock Mineral Wool products manufactured using ECOSE® Technology have been awarded Eurofins 'Indoor Air Comfort GOLD' certification.

### HOW MINERAL WOOL HELPS CREATE COMFORTABLE INDOOR ENVIRONMENTS

When installed correctly, our Mineral Wool insulation solutions help maintain stable inside temperatures by slowing heat transfer, keeping buildings warm when it's cold outside, and cool when it's warm. By preventing air leaks, uncontrolled condensation and possible mould spores, mildew or microbial organic compounds, a well-insulated, airtight building can help maintain a healthy environment.



# MINERAL WOOL INSULATION WITH THE FEEL GOOD FACTOR

**ECOSE® Technology is our unique bio-based binder which is used in the manufacture of all of our Glass Mineral Wool products, and the majority of our Rock Mineral Wool products.**

Our Mineral Wool made with ECOSE® Technology contains no added formaldehyde or phenol. This means our insulation generates very low levels of dust, increasing the comfort of those handling it. ECOSE® Technology makes our insulation soft to touch and easy to handle.

It is made from natural raw materials that are rapidly renewable and is 70% less energy-intensive to manufacture than traditional binders, so it is kinder to the environment too.

with **ECOSE®** TECHNOLOGY

**ECOSE®** TECHNOLOGY

## HOW DO YOU KNOW IT'S MANUFACTURED USING ECOSE® TECHNOLOGY?

Products manufactured using ECOSE® Technology have a natural brown colour so you can see, as well as feel the difference.

Traditional (not Knauf Insulation, non ECOSE® Technology) mineral wool insulation

Knauf Insulation with **ECOSE®** TECHNOLOGY





with **ECOSE**<sup>®</sup>  
TECHNOLOGY

- Soft to touch
- Low levels of dust
- Low VOCs\*

\*Volatile Organic Compounds



**70% less  
energy intensive to  
manufacture than  
traditional binders**

**No added  
formaldehyde or phenol**



# THE ONLY UK MANUFACTURER OF BOTH GLASS AND ROCK MINERAL WOOL INSULATION



CURED GLASS MINERAL WOOL



There is a broad spectrum of insulation materials available on the market, with an equally broad variance in form, performance, sustainability, cost-effectiveness and availability.

All our Mineral Wool products meet the highest specifications and have demonstrated excellent rounded performance in the most demanding projects, including those built to the Passivhaus standard.



**EUCEB** - an independent certification authority that guarantees our Mineral Wool products are made of certified bio-soluble fibres. This applies globally.

## Glass Mineral Wool

Our high performance Glass Mineral Wool insulation solutions contain up to 80% high quality recycled content, to which sand, limestone and soda ash is added before being melted in a furnace. The molten glass is spun to form millions of fine strands of wool.

To manufacture our Cured Glass Mineral Wool, we use our unique bio-based binder, ECOSE® Technology, to bind the mineral wool together to form a mat of material which is then cured in order to form the final product. The density of the product determines whether the insulation is a lightweight quilt supplied in rolls, a flexible slab or a rigid slab, and its thermal insulation value.

Our Blown Glass Mineral Wool is an un-bonded, virgin fibrous insulation, which is produced in the same way as the Cured Glass Mineral Wool, however, it is not cured but produced as a loose-fill product to be blown into cavity walls, partitions, timber frame walls and ceilings.

## Rock Mineral Wool

Our Rock Mineral Wool insulation solutions are mainly made from volcanic rock, typically basalt and/or dolomite. An increasing proportion is now recycled material from slag, a waste product from blast furnaces. The raw materials are melted and then spun into fine strands of wool. A binder is used to bind the wool together to form a mat of insulation, which is then cut into slabs or wired mattresses. Most of our Rock Mineral Wool products use our ECOSE® Technology.

## Industry-leading Compression Packaging

Our industry-leading compression packaging technology (up to 10:1 ratio across our Glass Mineral Wool products) allows for more product per pack, therefore less packaging used, less trucks on the roads and reduced transport related carbon emissions. All of which contributes to a low lifecycle impact. It also means our customers require less storage space, and less carrying and handling when compared to other products. As part of our continuous improvement process, we continually strive for further developments in our manufacturing and supply chain operations to enhance quality and minimise our impact on the environment.





BLOWN GLASS MINERAL WOOL



ROCK MINERAL WOOL

**RAL** – a German quality mark confirming Knauf Insulation’s Rock Mineral Wool products (including those made in the UK) are made of certified bio-soluble fibres and can be safely used for thermal & acoustic purposes.



	Glass Mineral Wool	Blowing Wool	Rock Mineral Wool
<b>Features</b>			
Naturally non-combustible	✓	✓	✓
Compression packed to limit transport & warehouse requirements	✓	✓	
Strand type	Long strands giving high levels of tear strength	Loose to allow blown installation	Short strands giving high levels of compressive strength
Available in slabs	✓		✓
Available in rolls	✓		
Available loose for blown installation		✓	
Available in wired mattresses			✓
Available with a variety of facings	✓		✓
<b>Applications</b>			
Residential buildings	✓	✓	✓
Commercial buildings	✓	✓	✓
New build	✓	✓	✓
Refurbishment	✓	✓	✓
Fire protection			✓

## Krimpact® Technology

A number of our Rock Mineral Wool products are manufactured using Krimpact® Technology which gives our products consistent density throughout, combined with superior impact and compression resistance. Krimpact® Technology aligns fibres in the Mineral Wool in such a way as to dramatically increase compressive strength and its ability to resist heavy loads.



# WE PROVIDE EXPERT ADVICE AND SUPPORT TO OUR CUSTOMERS

**At Knauf Insulation, we aim to support our customers to ensure our products are specified, procured and installed with the highest quality standards. Our dedicated Sales, Technical, Specification and Customer Service teams are here to provide advice to our customers and specifiers.**

## Technical Support Team

We offer expert advice on all our products and solutions through our in-house Technical Support Team.

With over 20 years insulation experience, our Technical Support Team provide free, expert advice for builders merchants, distributors, stockists, architects and any other customers involved in the construction industry and the wider specification community.

As well as technical advice, our Technical Support Team can provide U-value calculations, NBS clauses and 3D Heat Loss/U-value Calculations.

You can contact the team on 01744 766 666 or alternatively by email [technical.uk@knaufinsulation.com](mailto:technical.uk@knaufinsulation.com)

## Specification Team

If you need project specification support over the phone, online, on-site, or wish to book a CPD presentation we have a dedicated team of Project Specification Managers who cover all areas of the UK and Ireland.

Visit [knaufinsulation.co.uk/contact-finder](http://knaufinsulation.co.uk/contact-finder) to find your local representative.

## Marketing Support

We provide a fast turnaround on sample and literature requests, eliminating delays with planning and client approval of material, so that projects begin on time.

All our collaterals are also available on our website at [knaufinsulation.co.uk/all-downloads](http://knaufinsulation.co.uk/all-downloads)

## Specifications Documentations and Tools

### Building Information Modelling (BIM)

Our BIM objects are not only easily accessible and user-friendly; they are also packed with reliable, comprehensive data, such as DOP, EPDs and CE marking. They are available on our website at [knaufinsulation.co.uk/technical-support/building-information-modelling-bim](http://knaufinsulation.co.uk/technical-support/building-information-modelling-bim)

### Insulation CAD Details and NBS Specification Clauses

All our CAD details are available on our website in .DWG format and fully compatible with AutoCAD. You will need a version of AutoCAD or a .DWG viewer installed on your computer to view or use these files. They are available on our website at [knaufinsulation.co.uk/technical-support/nbs-cad](http://knaufinsulation.co.uk/technical-support/nbs-cad)

### BBA certifications

The British Board of Agrément offers third party certification for the use of building products and systems in critical applications. It is also incredibly important to specifiers, as it provides them with assurance that the product is manufactured to the highest level of quality, which have passed a series of comprehensive and rigorous assessments, ensuring the product is fit for purpose. You can find our BBA certificates at [knaufinsulation.co.uk/downloads/bba-certificates](http://knaufinsulation.co.uk/downloads/bba-certificates)

### Continuing Professional Development (CPD)

Our range of CPDs provide an essential service to architects and specifiers, helping them keep up to date in a rapidly changing and evermore challenging environment. [knaufinsulation.co.uk/technical-support/cpd](http://knaufinsulation.co.uk/technical-support/cpd)

# EXPLORE OUR ONLINE U-VALUE CALCULATOR

**Free, accurate and easy to use.**

**Do the seconds, minutes and hours quickly add up when conducting multiple U-value calculations per day?**

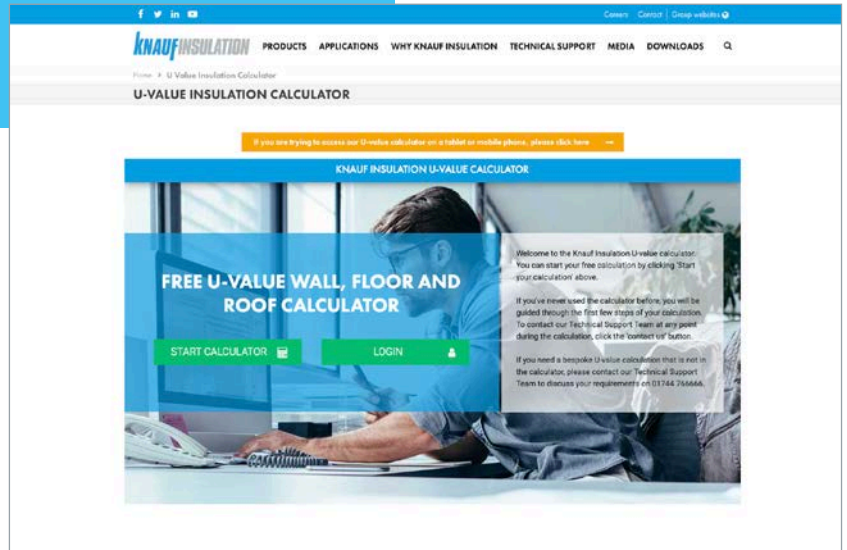

We are aware that your time is precious. With this in mind, we have launched our brand NEW U-value calculator that is quick and easy to use.

## Why use our online U-value calculator?

You can use our online U-value calculator to give you quick access to accurate U-values.

- Simply select the construction type and use the drop down menus to change individual components or corrections in the template.
- Once the U-value is calculated, you will be recommended the most suitable Knauf Insulation Glass or Rock Mineral Wool product for your roof, wall or floor application. You will be able to download detailed calculations, BIM files and product data, or send a copy of the calculation to your email address.
- If you need further assistance or information, our Technical Support Team will work with you on your project.

Our calculator follows the methodology of BRE calculations, in accordance with BS EN ISO 6946 and conventions given in BR443.

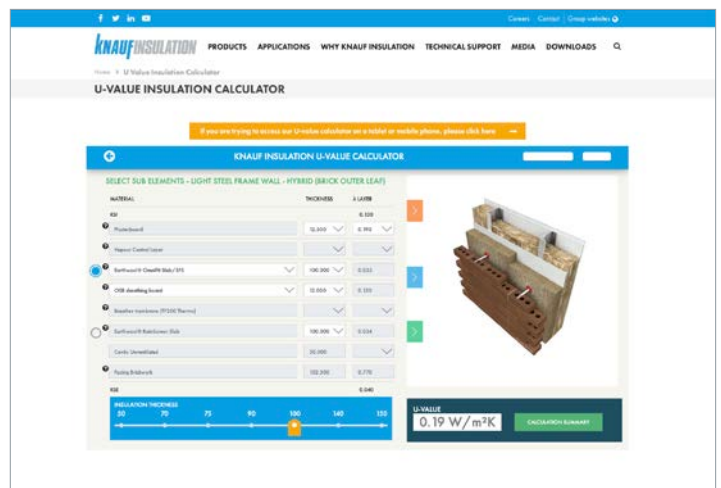

## All solutions included in the tool are non-combustible

We believe we have the most comprehensive and up to date range of materials in both Glass and Rock Mineral Wool to choose from, so you can be confident your U-value calculation is accurate and complies with Building Regulations.

Start your next calculation today by visiting [knaufinsulation.co.uk/uvalue-calculator](http://knaufinsulation.co.uk/uvalue-calculator)

# A RANGE OF HIGH PERFORMANCE PRODUCTS FOR ALL APPLICATIONS

**Built-up Metal Walls**  
FactoryClad Rolls  
See page 62

**Built-up Metal Roof**  
FactoryClad Rolls  
See page 40

**Flat Roof**  
Rocksilk® Flat Roof Slabs  
See page 36

**Green Roof**  
Urbanscape® Green Roof System  
See page 42

**Separating Floors (concrete)**  
Rocksilk® Acoustic Floor Slabs  
See page 78

**Separating Floors (timber)\***  
Rocksilk® Acoustic Floor Slabs  
See page 74

**Fire Protection (ducts)**  
Fire-teK BD 917  
See page 80

**Rainscreen Façade Systems**  
Rocksilk® RainScreen Slabs  
See page 56

**Fire Protection (structural steel)**  
Fire-teK Beam and Column Slabs  
See page 82

**Exposed Soffit**  
Rocksilk® Soffit Linerboards  
See page 72

\*Not pictured



**Separating (Party) Walls (blown-in)\***

Supafil® Party Wall

See page 66

**Separating (Party) Walls (built-in)**

Masonry Party Wall Slab

Timber Frame Party Wall Slab\*

See page 64

**Pitched Roof (rafter level)**

Rafter Roll

See page 34

**Pitched Roof (ceiling level)**

Loft Rolls

See page 32

**Green Roof**

Urbanscape® Green Roof System

See page 42

**Internal Floors**

Acoustic Roll

See page 79

**Suspended Timber Ground Floors**

OmniFit® Slab 35

See page 70

**Masonry Cavity Walls (built-in)**

DriTherm® Cavity Slabs

See page 44

**Masonry Cavity Walls\* (blown-in)**

Supafil® Blowing Wool

See page 46

**Internal Walls**

Acoustic Roll

See page 68

**Timber Frame Walls (built-in)\***

FrameTherm® Rolls & Slab

See page 50

**Timber Frame Walls (blown-in)\***

Supafil® Frame

See page 54

**External Wall Insulation\***

Rocksilk® EWI Slabs

See page 60

\*Not pictured



**Loft Roll 44** — between and above ceiling joists

Ceiling joist —



#### APPLICATION OVERVIEW

Insulation in cold lofts is installed in a number of layers with the first layer being laid between ceiling joists, and subsequent layers being laid at right angles to the ceiling joists, with all edges butt jointed to prevent thermal bridging and unwanted heat loss.

The principle consideration is thermal performance. Our loft insulation solutions provide excellent levels of thermal resistance in relation to cost of installation as thickness is largely unrestricted.

#### WHY MINERAL WOOL?

- Mineral Wool provides the best combination of thermal, fire safety and acoustic performance.
- Mineral Wool is easier to install correctly than other insulants such as rigid boards because it adapts to any slight imperfections in the substrate and knits together, eliminating any air gaps. Evidence shows the absence of air gaps is crucial to achieving real performance in the relevant application.

#### RECOMMENDED PRODUCT

- **Loft Roll 44** (see page 84)

#### OTHER SUITABLE PRODUCTS

- **Loft Roll 40** (see page 84)
- **OmniFit® Roll 40** (see page 102)



## TYPICAL U-VALUES

## LOFT ROLL 44

U-value (W/m <sup>2</sup> K)	Thickness (mm)		
	Between joists	Over joists	Total thickness
0.09	100	400 (2 x 200)	500
0.10	100	350 (150+200)	450
0.11	100	300 (2 x 150)	400
0.12	100	250 (100+150)	350
0.13	-	-	-
0.14	-	-	-
0.15	100	200	300
0.16	100	170	270

Note\* Joist sizes assumed to be 100 x 47mm at 400mm centres, default timber bridge fraction, 12.8% as per BR443. Assumed 12.5 mm standard plasterboard and cold ventilated roof with felt or sarking boards. All dimensions are nominal.

## LOFT ROLL 40 / OMNIFIT® ROLL 40

U-value (W/m <sup>2</sup> K)	Thickness (mm)		
	Between joists	Over joists	Total thickness
0.08	100	400 (2 x 200)	500
0.09	100	350 (150+200)	450
0.10	100	300 (2 x 150)	400
0.11	-	-	-
0.12	100	250 (100+150)	350
0.13	100	200	300
0.14	-	-	-
0.15	-	-	-
0.16	100	150	250

Note\* Joist sizes assumed to be 100 x 47mm at 400mm centres, default bridge fraction, 12.8% as per BR443. Assumed 12.5 mm standard plasterboard and cold ventilated roof with felt or sarking boards. All dimensions are nominal.

For any U-value calculations for alternative construction build-ups, please contact our Technical Support Team on 01744 766 666 or visit our online tool at [knaufinsulation.co.uk/uvalue-calculator](https://knaufinsulation.co.uk/uvalue-calculator)

For written U-value calculations, please email details of your full construction build-up to [technical.uk@knaufinsulation.com](mailto:technical.uk@knaufinsulation.com) and we will respond accordingly to meet your requirements.





### APPLICATION OVERVIEW

Insulation is friction-fitted between rafters, with the option to underline the rafters with a layer of non-combustible Rocksilk® RS45 to further enhance thermal performance.

As rooms-in-roof are usually used as bedrooms, acoustic performance and sound reduction of external noise should be considered in addition to thermal performance.

Our insulation solutions for warm roofs provide thermal efficiency, whilst also contributing to acoustic performance.

### RECOMMENDED PRODUCT

(Between rafters)

- **Rafter Roll 32** (see page 90)

### OTHER SUITABLE PRODUCTS

(Between rafters)

- **FrameTherm® Rolls and Slabs** (see page 88 and 100)
- **OmniFit® Roll 34** (see page 102)
- **OmniFit® Slab 35** (see page 104)
- **Rocksilk® RS45** (see page 116)
- **Rocksilk® Flexible Slab** (see page 118)

### RECOMMENDED PRODUCT

(Beneath rafters)

- **Rocksilk® RS45** (see page 116)

### WHY MINERAL WOOL?

- Mineral Wool provides the best combination of thermal, fire safety and acoustic performance.
- Mineral Wool is easier to install correctly than other insulants such as rigid boards because it adapts to any slight imperfections in the substrate and knits together, eliminating any air gaps. Evidence shows the absence of air gaps is crucial to achieving real performance in the relevant application.

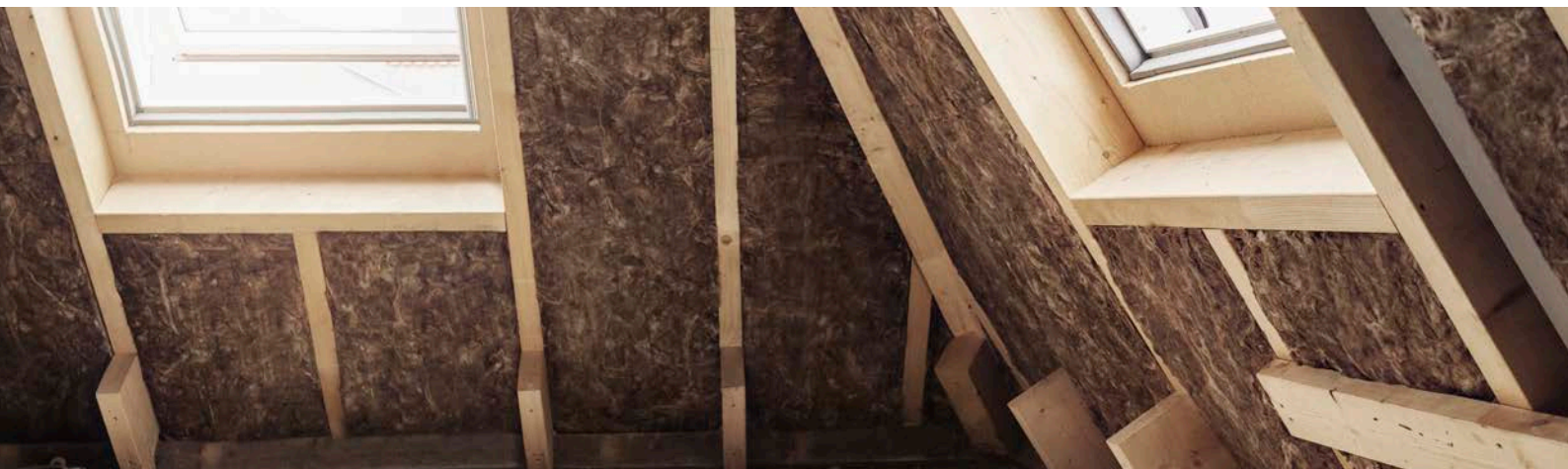

## TYPICAL U-VALUES

**USING BATTEN AND COUNTER BATTEN WITH RAFTER ROLL 32 (BETWEEN RAFTERS) AND ROCKSILK® RS45 BETWEEN BATTENS INTERNALLY**

- with LR underlay pulled taut and insulation to full depth of rafters

<b>Rafter Roll 32 thickness (mm)</b>	<b>U-value (W/m<sup>2</sup>K)</b>	
	<b>Rocksilk® RS45 thickness (mm)</b>	
	<b>25</b>	<b>50</b>
250 (100+2x75)	0.14	0.13
225 (3 x 75)	0.15	0.14
200 (2 x 100)	0.17	0.15
175 (100+75)	0.19	0.17
150 (2 x 75)	0.21	0.18
100 (1 x 100)	0.28	0.24

Note: Rafter sizes assumed to be 38mm wide at 600mm centres (6.3% bridging and the same depth as the insulation).  
Rocksilk® RS45 (0.035 W/mK) installed internally between 47mm wide timber battens at 600mm centres.  
(1.2% bridging and the same depth as the insulation layer). 12.5mm Plasterboard internal finish (λ0.190).

**USING BATTEN AND COUNTER BATTEN WITH RAFTER ROLL 32 (BETWEEN RAFTERS)**

-with LR underlay pulled taut and insulation to full depth of rafters.

<b>Rafter Roll 32 thickness (mm)</b>	<b>U-value (W/m<sup>2</sup>K)</b>
250 (100+2x75)	0.16
225 (3 x 75)	0.17
200 (2 x 100)	0.19
175 (100+75)	0.21
150 (2 x 75)	0.25

Note: Rafter sizes assumed to be 38mm wide at 600mm centres (6.3% bridging and the same depth as the insulation). 12.5mm Plasterboard internal finish (λ0.190).

**USING RAFTER ROLL 32 (BETWEEN RAFTERS) AND ROCKSILK® RS45 BETWEEN BATTENS INTERNALLY** -With draped membrane and 50mm air gap to insulation

<b>Rafter Depth</b>	<b>Rafter Roll 32 thickness (mm)</b>	<b>U-value (W/m<sup>2</sup>K)</b>		
		<b>Rocksilk® RS45 thickness (mm)</b>		
		<b>None</b>	<b>25</b>	<b>50</b>
250	200 (2x100)	0.18	0.17	0.15
225	175 (100+75)	0.21	0.19	0.17
200	150 (2x75)	0.23	0.21	0.18
150	100 (1x100)	0.32	0.28	0.24

Note: Rafter sizes assumed to be 38mm wide at 600mm centres (6.3% bridging and the same depth as the insulation plus the airspace).  
A nominal 50mm ventilated airspace is required between Rafter Roll and the existing HR roof tile underlay. Rocksilk® RS45  
(0.035 W/mK) installed internally between 47mm wide timber battens at 600mm centres. (1.2% bridging and the same depth as the  
insulation layer). 12.5mm Plasterboard internal finish (λ0.190). Where no Rocksilk® RS45 is installed between battens the service void  
has an assumed airspace resistance of 0.160.

For any U-value calculations for alternative construction build-ups, please contact our  
Technical Support Team on 01744 766 666 or visit our online tool at [knaufinsulation.co.uk/uvalue-calculator](http://knaufinsulation.co.uk/uvalue-calculator)

For written U-value calculations, please email details of your full construction build-up to [technical.uk@knaufinsulation.com](mailto:technical.uk@knaufinsulation.com) and we will respond accordingly to meet your requirements.

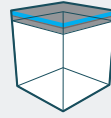
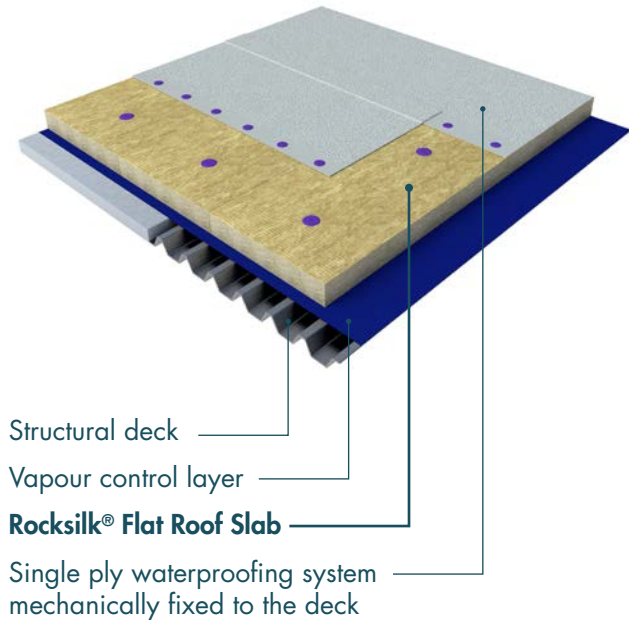

### APPLICATION OVERVIEW

Mechanically fixed, single ply build-ups consist of a system that is held in position by mechanical fasteners alone. These secure the membrane over the top of the insulation and VCL, and are fastened in place into the roof deck. Mechanically fixed single ply is suited to applications where speed of installation is key, such as schools.

Our insulation solutions for flat roofs provide both excellent fire and acoustic performance in addition to high levels of thermal performance.

### RECOMMENDED PRODUCTS

- **Rocksilk® Flat Roof Slab** (See page 126)
- **Rocksilk® Flat Roof Slab Extra** (See page 126)



\*not Extra

### WHY MINERAL WOOL?

- Mineral Wool provides the best combination of thermal, fire safety and acoustic performance.
- When manufactured using Knauf Insulation's Krimpac® Technology it provides high levels of compressive strength and durability. It is also non-combustible, with the best possible Euroclass A1 reaction to fire classification.





## TYPICAL U-VALUES

## USING ROCKSILK® FLAT ROOF SLAB WITH SINGLE PLY MEMBRANE

Rocksilk® Flat Roof Slab thickness (mm)	U-value (W/m <sup>2</sup> K)		
	150mm concrete 40mm screed 13mm plaster	Profiled metal deck	19mm OSB, 100mm timber joists 12.5mm standard plasterboard
360 (2x180)	0.11	0.11	0.10
325 (180+145)	0.12	0.12	0.11
290 (2x145)	0.13	0.13	0.13
245 (145+100)	0.15	0.16	0.15
200 (2x100)	0.19	0.19	0.18
180	0.21	0.21	0.19

## USING ROCKSILK® FLAT ROOF SLAB EXTRA WITH SINGLE PLY MEMBRANE

Rocksilk® Flat Roof Slab Extra thickness (mm)	U-value (W/m <sup>2</sup> K)		
	150mm concrete 40mm screed 13mm plaster	Profiled metal deck	19mm OSB, 100mm timber joists 12.5mm standard plasterboard
300 (2x150)	0.13	0.13	0.12
275 (150+125)	0.14	0.14	0.13
250 (2x125)	0.15	0.16	0.15
230 (125+105)	0.17	0.17	0.16
210 (2x105)	0.18	0.19	0.17
190 (2x95)	0.20	0.20	0.19

For any U-value calculations for alternative construction build-ups, please contact our Technical Support Team on 01744 766 666 or visit our online tool at [knaufinsulation.co.uk/uvalue-calculator](https://knaufinsulation.co.uk/uvalue-calculator)

For written U-value calculations, please email details of your full construction build-up to [technical.uk@knaufinsulation.com](mailto:technical.uk@knaufinsulation.com) and we will respond accordingly to meet your requirements.

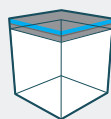

### APPLICATION OVERVIEW

Cold flat roofs consist of insulating between joists, or between and below joists to meet building regulations. A cavity should be left between the insulation and the waterproofing layer for ventilation purposes.

Often chosen for refurbishment applications, our insulation solutions for flat roof applications provide both excellent fire and acoustic performance, in addition to high levels of thermal performance.

### RECOMMENDED PRODUCTS

- **OmniFit® Slab 35** (See page 104)
- **Rocksilk® RS45** (See page 116)

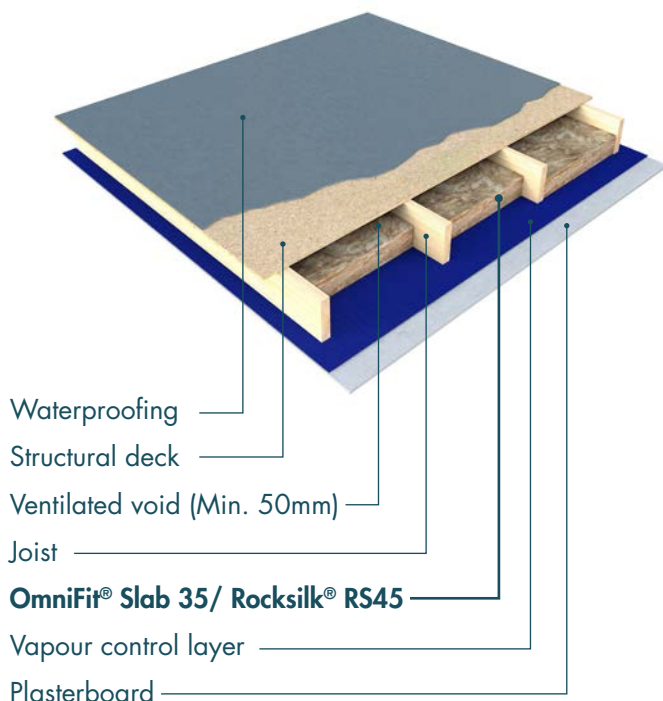

Waterproofing

Structural deck

Ventilated void (Min. 50mm)

Joist

**OmniFit® Slab 35 / Rocksilk® RS45**

Vapour control layer

Plasterboard

### WHY MINERAL WOOL?

- Mineral Wool provides the best combination of thermal, fire safety and acoustic performance.
- When manufactured using Knauf Insulation's Krimpac® Technology it provides high levels of compressive strength and durability. It is also non-combustible, with the best possible Euroclass A1 reaction to fire classification.



## TYPICAL U-VALUES

## USING OMNIFIT® SLAB 35 / ROCKSILK® RS45 WITH SINGLE PLY MEMBRANE

Joist depth (mm)	OmniFit® Slab 35 / Rocksilk® RS45 thickness (mm)	U-value (W/m <sup>2</sup> K)			
		Knauf Insulated Plasterboard thickness (mm)			
		35	50	65	75
250	200 (2x100)	0.16	0.15	0.13	0.13
225	175 (100+75)	0.18	0.16	0.15	0.14
200	150	0.20	0.18	0.16	0.15
175	125 (75+50)	0.23	0.20	0.18	0.16
150	100	0.27	0.23	0.20	0.18

For any U-value calculations for alternative construction build-ups, please contact our Technical Support Team on 01744 766 666 or visit our online tool at [knaufinsulation.co.uk/uvalue-calculator](https://knaufinsulation.co.uk/uvalue-calculator)

For written U-value calculations, please email details of your full construction build-up to [technical.uk@knaufinsulation.com](mailto:technical.uk@knaufinsulation.com) and we will respond accordingly to meet your requirements.



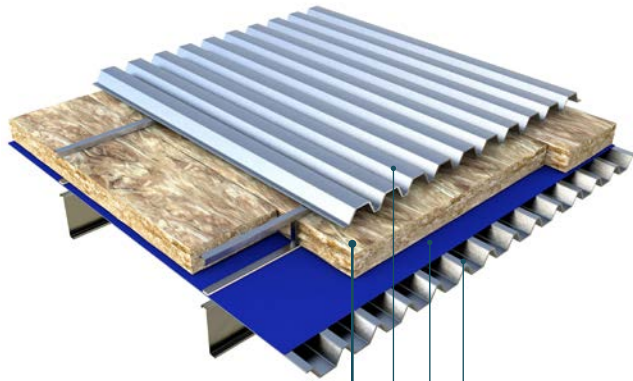

### FactoryClad Roll 40

Profiled metal outer sheet

Vapour control layer

Perforated metal liner sheet

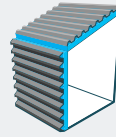

### APPLICATION OVERVIEW

Built-up metal roof systems typically consist of a low profile metal inner liner sheet, separated from an outer, higher profile metal weather sheet and are typically assembled on site.

The cavity between them is filled with a layer of insulation to provide the specified level of thermal performance. As well as thermal performance acoustic performance is also important.

Our Mineral Wool insulation solutions for built-up metal roofs provide excellent levels of sound absorption, reducing the drumming effect of rainwater and improving the overall acoustic performance of the roof.

### WHY MINERAL WOOL?

- Mineral Wool provides the best combination of thermal, fire safety and acoustic performance.
- Mineral Wool is easier to install correctly than other insulants such as rigid boards because it adapts to any slight imperfections in the substrate and knits together, eliminating any air gaps. Evidence shows the absence of air gaps is crucial to achieving real performance in the relevant application.

### RECOMMENDED PRODUCT

- **FactoryClad Roll 40** (see page 86)

### OTHER SUITABLE PRODUCTS

- **FactoryClad Roll 32** (see page 86)

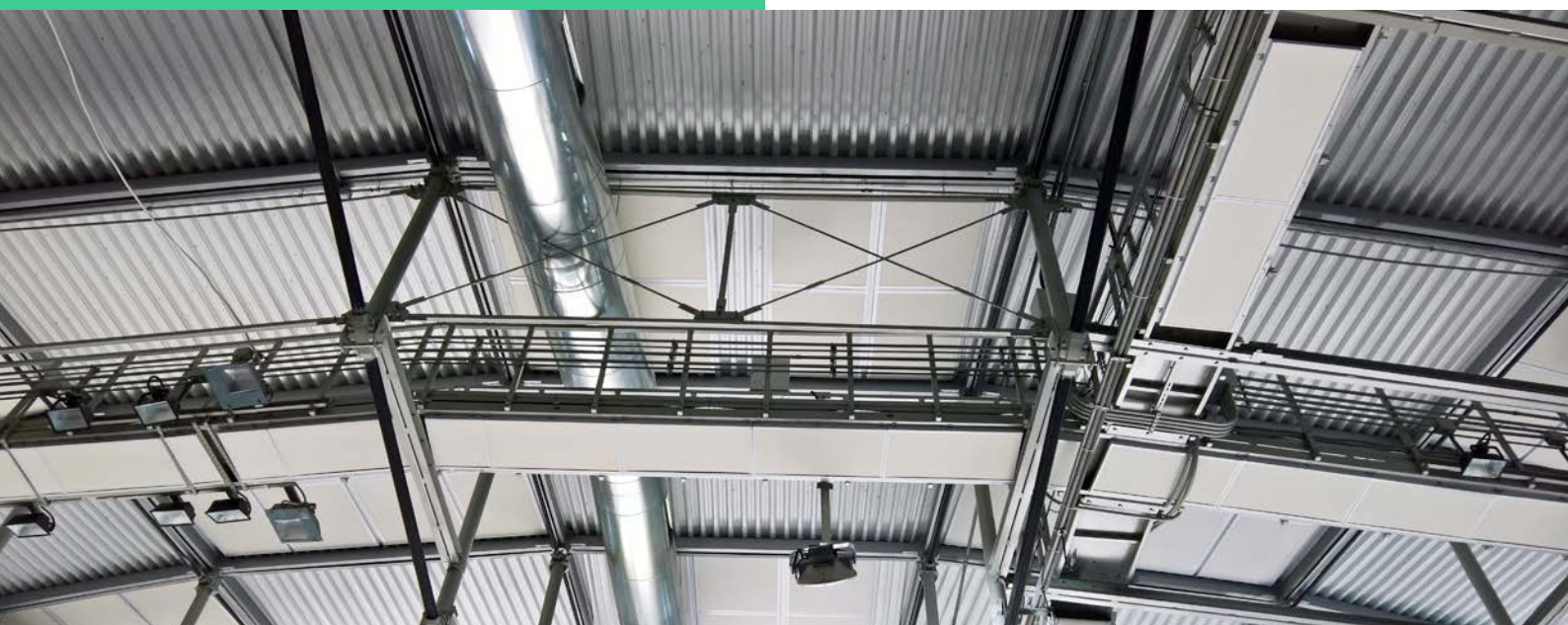

## TYPICAL U-VALUES

## USING FACTORYCLAD ROLL 40

FactoryClad Roll 40 thickness (mm)	U-value (W/m <sup>2</sup> K)
	Rails at 1.20metre spacings
440 (2x220)	0.11
400 (2x200)	0.12
360 (2x180)	0.13
340 (200+140)	0.14
320 (2x160)	0.15
300 (200+100)	0.16
280 (2x140)	0.17
260 (160+100)	0.18
240 (2x120)	0.19
220	0.21
200	0.23
180	0.25

NOTE: Knauf Insulation recommends that the roof system designer / manufacturer is contacted for U-values specific to their systems.

## USING FACTORYCLAD ROLL 32

FactoryClad Roll 32 thickness (mm)	U-value (W/m <sup>2</sup> K)
	Rails at 1.20metre spacings
160 (2x80)	0.24

NOTE: Knauf Insulation recommends that the roof system designer / manufacturer is contacted for U-values specific to their systems.

These U-values are taken from default values in the BRE U-value calculator using twin-skin metal panel-rail and bracket system as examples only.

To ensure an accurate U-value calculation, the roof or wall manufacturer should be contacted for the U-value specific to the system and associated components being used.

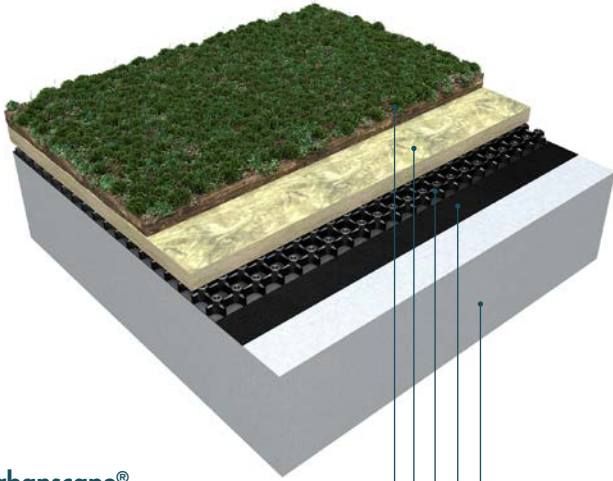

### Urbanscape® Green Roof System is made up of:

- Urbanscape® Sedum-Mix Blanket
- Urbanscape® Green Roll Substrate
- Urbanscape® Drainage with Buffer
- Urbanscape® Root Membrane
- Roof Substrate

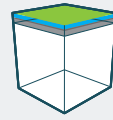

### APPLICATION OVERVIEW

Key considerations when designing green roofs include overall weight of the system to ensure it can be supported by the roof structure, in addition to water retention capability of the system to minimise stormwater run-off.

Our Mineral Wool green roof growing mediums help to produce innovative extensive green roofs which support sedum, moss, herbs, grasses and other vegetation where low or no maintenance is required.

### RECOMMENDED PRODUCT

- **Urbanscape® Green Roof System** (see page 134)

### WHY MINERAL WOOL?

- Mineral Wool provides the best combination of thermal, fire safety and acoustic performance.
- Mineral Wool substrates can be 8-10 times lighter than regular Green Roof substrates, meaning they can be installed onto lightweight constructions where traditional systems are otherwise not possible.





## GREEN ROOF BENEFITS



### EXTENDED ROOF LIFE

Green roofs have been shown to **triple the life expectancy of the roof**. The underlying roof materials are protected from mechanical damage, ultraviolet radiation and extreme temperatures, which results in reduced maintenance and renovation costs.



### RAINWATER RETENTION

A major advantage of green roofs is the reduction of storm water run-off, which leads to **a decrease of the burden on sewer systems by 70-95% in summer**. Green roofs have influence on cost due to low or no need for rain-catching cisterns and similar equipment which is usually used for storm water management.



### CO<sub>2</sub> REDUCTION

Green roofs help to reduce the amount of CO<sub>2</sub> in the air, which is one of the most important causes of global warming. **1m<sup>2</sup> of a green roof can absorb 5kg of CO<sub>2</sub> yearly**. 1m<sup>2</sup> of green roof can absorb the same quantity of CO<sub>2</sub> as a regular car would emit during an 80 km drive.



### CLEANER AIR

The plants on green roofs can also capture airborne particles such as smog, heavy metals and Volatile Organic Compounds (VOCs) from the local atmosphere which has a positive effect on air quality and health of inhabitants. **Researchers estimate that 1m<sup>2</sup> of a green roof can help to absorb 0.2 kg of airborne particles from the air every year\***.



### NOISE REDUCTION

A green roof system provides good sound insulation, **keeps the living space quieter** and creates more pleasant surroundings in urban areas, and it contributes to noise reduction in large cities, near industrial areas and airports.

\*United States Environmental Protection Agency EPA -Reducing UHI: Compendium of Strategies

## AVAILABLE INSULATION CPD COURSE

# LIGHTWEIGHT GREEN ROOF SYSTEMS:

## Design considerations and innovative solutions

The CPD includes the following topics:

- An overview of the various types of green roof
- Design considerations for effective green roof systems
- Common problems associated with traditional green roof systems
- Innovative solutions to overcome common pitfalls

Visit [knaufinsulation.co.uk/technical-support/cpd](https://knaufinsulation.co.uk/technical-support/cpd) to book your CPD today!

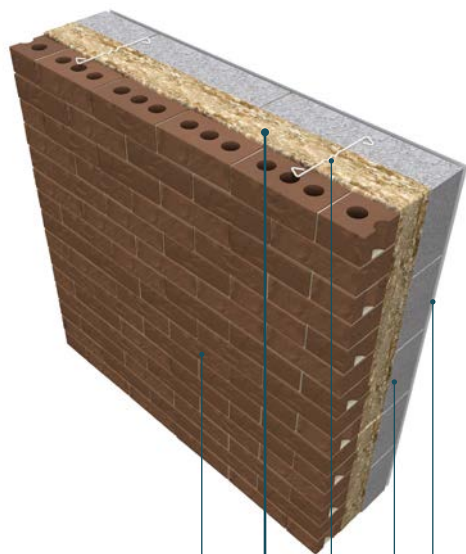

Brick outer leaf  
**DriTherm® Cavity Slab 32**  
 Suitable wall tie  
 Blockwork inner leaf  
 Plasterboard on dabs



### APPLICATION OVERVIEW

Full-fill built-in insulation solutions are installed as the walls are built, with slabs being friction-fitted between the inner and outer leaves of the wall and in between wall ties.

The principle consideration is thermal performance with a requirement for the insulation to be in intimate contact with both leaves of the wall to prevent air movement and subsequent heat loss.

Our non-combustible DriTherm® Cavity Slabs are designed to fully fill the cavity and are BBA certified for use in all exposure zones.

### RECOMMENDED PRODUCT

- **DriTherm® Cavity Slab 32** (see page 94)

### OTHER SUITABLE PRODUCTS

- **DriTherm® Cavity Slab 34** (see page 94)
- **DriTherm® Cavity Slab 37** (see page 94)



### WHY MINERAL WOOL?

- Mineral Wool provides the best combination of thermal, fire safety and acoustic performance.
- Mineral Wool is easier to install correctly than other insulants such as rigid boards because it adapts to any slight imperfections in the substrate and knits together, eliminating any air gaps. Evidence shows the absence of air gaps is crucial to achieving real performance in the relevant application.



## TYPICAL U-VALUES

### BUILT-IN USING DRITHERM® CAVITY SLAB 32

DriTherm® Cavity Slab 32 thickness (mm)	U-value (W/m <sup>2</sup> K)			
	Medium block (0.45 W/mK)	High strength aircrete (0.19 W/mK)	Standard aircrete (0.15 W/mK)	Lightweight aircrete (0.11 W/mK)
300 (2x150)	0.11	0.10	0.10	0.10
200 (2x100)	0.15	0.15	0.14	0.14
150	0.19	0.18	0.17	0.17
125	0.22	0.21	0.20	0.20
100	0.26	0.25	0.24	0.23

NOTE: The U-values have been calculated assuming that all walls are lined with 12.5mm standard plasterboard on dabs on standard blocks with 10mm mortar joints. Wall ties assumed to be stainless steel at 2.5 per m<sup>2</sup> with a cross-sectional area of no more than 12.5mm<sup>2</sup> for structural cavities up to 100mm wide. For cavities greater than 100mm up to 150mm, the cross sectional area of wall ties is assumed to be 24mm<sup>2</sup>. For cavities above 150mm, the cross sectional area of wall ties is assumed to be 60mm<sup>2</sup>. Air gap correction level is zero. Multiple layers are required for several of the solutions detailed above.

### BUILT-IN USING DRITHERM® CAVITY SLAB 34

DriTherm® Cavity Slab 34 thickness (mm)	U-value (W/m <sup>2</sup> K)			
	Medium block (0.45 W/mK)	High strength aircrete (0.19 W/mK)	Standard aircrete (0.15 W/mK)	Lightweight aircrete (0.11 W/mK)
300 (3x100)	0.11	0.11	0.11	0.10
200 (2x100)	0.16	0.15	0.15	0.15
150 (2x75)	0.20	0.19	0.18	0.18
125	0.23	0.22	0.21	0.20
100	0.27	0.26	0.25	0.24

NOTE: The U-values have been calculated assuming that all walls are lined with 12.5mm standard plasterboard on dabs on standard blocks with 10mm mortar joints. Wall ties assumed to be stainless steel at 2.5 per m<sup>2</sup> with a cross-sectional area of no more than 12.5mm<sup>2</sup> for structural cavities up to 100mm wide. For cavities greater than 100mm up to 150mm, the cross sectional area of wall ties is assumed to be 24mm<sup>2</sup>. For cavities above 150mm, the cross sectional area of wall ties is assumed to be 60mm<sup>2</sup>. Air gap correction level is zero. Multiple layers are required for several of the solutions detailed above.

### BUILT-IN USING DRITHERM® CAVITY SLAB 37

DriTherm® Cavity Slab 37 thickness (mm)	U-value (W/m <sup>2</sup> K)			
	Medium block (0.45 W/mK)	High strength aircrete (0.19 W/mK)	Standard aircrete (0.15 W/mK)	Lightweight aircrete (0.11 W/mK)
300 (2x150)	0.12	0.12	0.11	0.11
200 (2x100)	0.17	0.16	0.16	0.16
150	0.21	0.20	0.20	0.19
125	0.25	0.23	0.23	0.22
100	0.29	0.27	0.27	0.26

NOTE: The U-values have been calculated assuming that all walls are lined with 12.5mm standard plasterboard on dabs on standard blocks with 10mm mortar joints. Wall ties assumed to be stainless steel at 2.5 per m<sup>2</sup> with a cross-sectional area of no more than 12.5mm<sup>2</sup> for structural cavities up to 100mm wide. For cavities greater than 100mm up to 150mm, the cross sectional area of wall ties is assumed to be 24mm<sup>2</sup>. For cavities above 150mm, the cross sectional area of wall ties is assumed to be 60mm<sup>2</sup>. Air gap correction level is zero. Multiple layers are required for several of the solutions detailed above.

For any U-value calculations for alternative construction build-ups, please contact our Technical Support Team on 01744 766 666 or visit our online tool at [knaufinsulation.co.uk/uvalue-calculator](http://knaufinsulation.co.uk/uvalue-calculator)

For written U-value calculations, please email details of your full construction build-up to [technical.uk@knaufinsulation.com](mailto:technical.uk@knaufinsulation.com) and we will respond accordingly to meet your requirements.



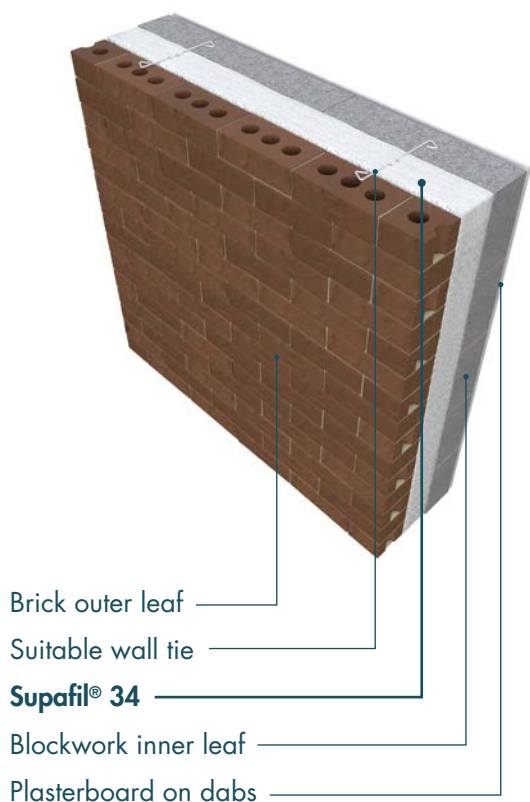

#### APPLICATION OVERVIEW

New build full-fill blown-in insulation solutions are installed via a series of pre-drilled installation holes by approved technicians once walls are built and when the building is watertight.

The principle consideration is thermal performance with a requirement for the insulation to be in intimate contact with both leaves of the wall to prevent air movement and subsequent heat loss.

Our non-combustible Supafil® blown insulation systems are designed to fully fill the cavity and are BBA certified for use in all exposure zones.

#### RECOMMENDED PRODUCT

- **Supafil® 34** (see page 106)

#### WHY MINERAL WOOL?

- Mineral Wool provides the best combination of thermal, fire safety and acoustic performance.
- Mineral Wool is easier to install correctly than other insulants such as rigid boards because it adapts to any slight imperfections in the substrate and knits together, eliminating any air gaps. Evidence shows the absence of air gaps is crucial to achieving real performance in the relevant application.



## TYPICAL U-VALUES

### BLOWN-IN (INJECTED) USING SUPAFIL® 34

Cavity width thickness (mm)	U-value (W/m <sup>2</sup> K)			
	Medium block (0.45 W/mK)	High strength aircrete (0.19 W/mK)	Standard aircrete (0.15 W/mK)	Lightweight aircrete (0.11 W/mK)
300	0.11	0.11	0.11	0.10
200	0.16	0.15	0.15	0.15
150	0.20	0.19	0.18	0.18
125	0.23	0.22	0.21	0.20
100	0.28	0.26	0.25	0.24

*Note: The U-values have been calculated assuming that all walls are lined with 12.5mm standard plasterboard on dabs on standard blocks with 10mm mortar joints. Wall ties assumed to be stainless steel at 2.5 per m<sup>2</sup> with a cross-sectional area of no more than 12.5mm<sup>2</sup> for structural cavities up to 100mm wide. For cavities greater than 100mm up to 150mm, the cross sectional area of wall ties is assumed to be 24mm<sup>2</sup>. For cavities above 150mm, the cross sectional area of wall ties is assumed to be 60mm<sup>2</sup>. Air gap correction level is zero.*

**For any U-value calculations for alternative construction build-ups, please contact our Technical Support Team on 01744 766 666 or visit our online tool at [knaufinsulation.co.uk/uvalue-calculator](https://knaufinsulation.co.uk/uvalue-calculator)**

For written U-value calculations, please email details of your full construction build-up to [technical.uk@knaufinsulation.com](mailto:technical.uk@knaufinsulation.com) and we will respond accordingly to meet your requirements.

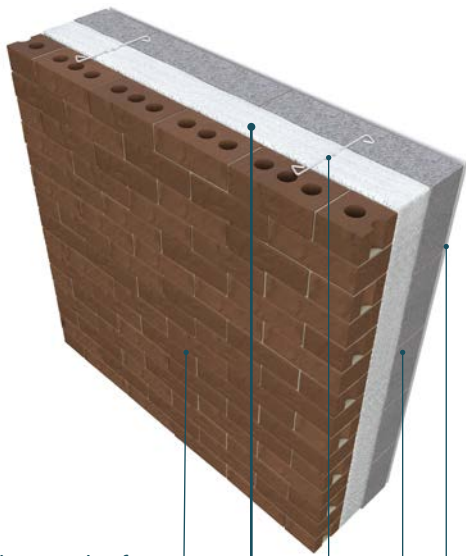

Brick outer leaf

**Supafil® 40 /  
Supafil® CarbonPlus**

Suitable wall tie

Blockwork inner leaf

Plasterboard



#### APPLICATION OVERVIEW

Retrofit full-fill blown-in insulation solutions are installed via a series of pre-drilled installation holes by approved technicians from the outside of a property.

The principle consideration is thermal performance with a requirement for the insulation to be in intimate contact with both leaves of the wall to prevent air movement and subsequent heat loss.

Our non-combustible Supafil® blown insulation systems are designed to fully fill the cavity and are BBA certified for use in all exposure zones.

#### RECOMMENDED PRODUCT

Cavities above 50mm

- **Supafil® 40** (see page 106)



Cavities above 40mm

- **Supafil® CarbonPlus** (see page 108)



#### WHY MINERAL WOOL?

- Mineral Wool provides the best combination of thermal, fire safety and acoustic performance.
- Mineral Wool is easier to install correctly than other insulants such as rigid boards because it adapts to any slight imperfections in the substrate and knits together, eliminating any air gaps. Evidence shows the absence of air gaps is crucial to achieving real performance in the relevant application.





## TYPICAL U-VALUES

**FOR FULLY FILLED MASONRY CAVITY WALLS - EXISTING - USING SUPAFIL® 40**  
(BRICK OUTER LEAF / CAVITY / 100MM INNER LEAF AS DETAILED BELOW)

Cavity width (mm)	U-value (W/m <sup>2</sup> K)			
	Brick (0.56 W/mK)	Block (1.13 W/mK)	Block (0.51 W/mK)	Block (0.34 W/mK)
100	0.32	0.33	0.31	0.31
85	0.36	0.37	0.36	0.35
75	0.39	0.41	0.39	0.38
65	0.44	0.45	0.43	0.42
50	0.52	0.55	0.52	0.50

Note: The U-values have been calculated assuming that all walls are lined with 12.5mm standard plasterboard on dabs on standard blocks with 10mm mortar joints. Wall ties assumed to be stainless steel at 2.5 per m<sup>2</sup> with a cross-sectional area of 100mm - 12.5mm<sup>2</sup>, >100 - 150mm - 24mm<sup>2</sup>, >150mm - 60mm<sup>2</sup>. Air gap correction level is zero.

**FOR FULLY FILLED MASONRY CAVITY WALLS - EXISTING - USING SUPAFIL® CARBON PLUS**  
(BRICK OUTER LEAF / CAVITY / 100MM INNER LEAF AS DETAILED BELOW)

Cavity width (mm)	U-value (W/m <sup>2</sup> K)			
	Brick (0.56 W/mK)	Block (1.13 W/mK)	Block (0.51 W/mK)	Block (0.34 W/mK)
100	0.28	0.28	0.28	0.27
85	0.32	0.33	0.31	0.31
75	0.35	0.36	0.35	0.34
65	0.39	0.40	0.39	0.37
50	0.47	0.49	0.46	0.45

Note: The U-values have been calculated assuming that all walls are lined with 12.5mm standard plasterboard on dabs on standard blocks with 10mm mortar joints. Wall ties assumed to be stainless steel at 2.5 per m<sup>2</sup> with a cross-sectional area of 100mm - 12.5mm<sup>2</sup>, >100 - 150mm - 24mm<sup>2</sup>, >150mm - 60mm<sup>2</sup>. Air gap correction level is zero.

For any U-value calculations for alternative construction build-ups, please contact our Technical Support Team on 01744 766 666 or visit our online tool at [knaufinsulation.co.uk/uvalue-calculator](http://knaufinsulation.co.uk/uvalue-calculator)

For written U-value calculations, please email details of your full construction build-up to [technical.uk@knaufinsulation.com](mailto:technical.uk@knaufinsulation.com) and we will respond accordingly to meet your requirements.

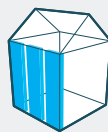
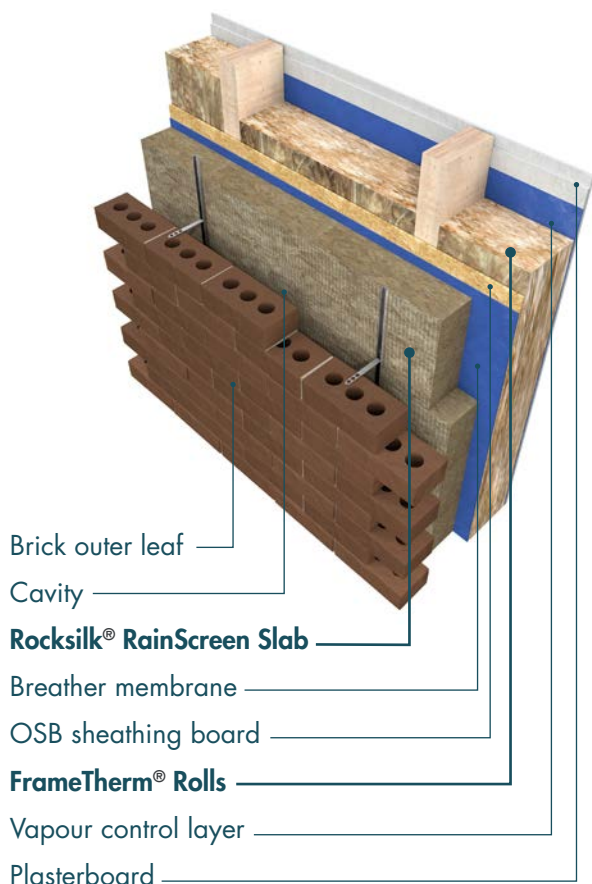

#### APPLICATION OVERVIEW

Mineral Wool rolls or slabs are friction-fitted between timber studs with additional non-combustible insulation partially filling the external cavity to further enhance thermal performance.

The reaction to fire classification of insulation products is an important consideration in order to minimise the chance of fire spread through the cavity. In addition, the reduced mass of timber frame walls means that insulation materials need to provide a higher level of acoustic performance to compensate.

Our non-combustible solutions for timber frame buildings are designed to friction fit between studs to minimise heat loss, whilst also providing acoustic absorption to enhance the overall acoustic performance of the wall.

#### RECOMMENDED PRODUCTS

(Between timber studs)

- **FrameTherm® Rolls** (see page 88)  
(Partially filled cavity)
- **Rocksilks® RainScreen Slab** (see page 114)

#### OTHER SUITABLE PRODUCTS

(Between timber studs)

- **FrameTherm® Slab 32** (see page 100)
- **OmniFit® Slab 35** (see page 104)
- **Rocksilks® RS45** (see page 116)
- **Rocksilks® Flexible Slab** (see page 118)

#### WHY MINERAL WOOL?

- Mineral Wool provides the best combination of thermal, fire safety and acoustic performance.
- Mineral Wool is easier to install correctly than other insulants such as rigid boards because it adapts to any slight imperfections in the substrate and knits together, eliminating any air gaps. Evidence shows the absence of air gaps is crucial to achieving real performance in the relevant application.



## TYPICAL U-VALUES

**FOR PARTIALLY FILLED MASONRY CAVITIES – NEW- USING ROCKSILK® RAINSCREEN SLAB  
(BRICK OUTER LEAF / CAVITY / TIMBER FRAME INNER LEAF AS DETAILED BELOW)**

<b>U-value (W/m<sup>2</sup>K)</b>		
102.5mm Brick outer leaf or 100mm Dense block and render		
FrameTherm® Roll / Slab 32		
<b>Rocksilk® RainScreen Slab (mm)</b>	<b>90mm</b>	<b>140mm</b>
250	0.10	0.09
210	0.11	0.10
200	0.11	0.10
180	0.12	0.11
150	0.14	0.12
120	0.16	0.13
100	0.17	0.14
75	0.20	0.16
50	0.23	0.18

Note: Default timber fraction BR443:2019. Timber studs fully filled with FrameTherm® Roll or Slab 32 (0.032W/mK). 9mm sheathing and 2x15mm Standard wallboard internal finish. Rocksilk® Rainscreen Slab (0.034W/mK) installed with 50mm residual cavity using ACS 25/15 Framefix restraint system secured with stainless steel fixings.

The above values are for guidance only, please contact our Technical Support Team direct for specific values.

## TYPICAL U-VALUES

**FOR PARTIALLY FILLED MASONRY CAVITIES – NEW- USING ROCKSILK® RAINSCREEN SLAB  
(BRICK OUTER LEAF / CAVITY / TIMBER FRAME INNER LEAF AS DETAILED BELOW)**

<b>U-value (W/m<sup>2</sup>K)</b>					
102.5mm Brick outer leaf or 100mm Dense block and render					
OmniFit® Slab 35					
<b>Rocksilk® RainScreen Slab (mm)</b>	<b>90mm</b>	<b>100mm</b>	<b>140mm</b>	<b>150mm</b>	<b>200mm</b>
250	0.10	0.10	0.09	0.09	0.08
210	0.11	0.11	0.10	0.10	0.09
200	0.12	0.11	0.10	0.10	0.09
180	0.12	0.12	0.11	0.11	0.10
150	0.14	0.14	0.12	0.12	0.10
120	0.16	0.15	0.14	0.13	0.12
100	0.18	0.17	0.15	0.14	0.13
75	0.20	0.19	0.17	0.16	0.14
50	0.24	0.23	0.19	0.18	0.15

Note: Default timber fraction BR443:2019. Timber studs fully filled with OmniFit® Slab 35 (0.035W/mK). 9mm sheathing and 2x15mm Standard wallboard internal finish. Rocksilk® Rainscreen Slab (0.034W/mK) installed with 50mm residual cavity using ACS 25/15 Framefix restraint system secured with stainless steel fixings.

The above values are for guidance only, please contact our Technical Support Team direct for specific values.

**For any U-value calculations for alternative construction build-ups, please contact our Technical Support Team on 01744 766 666 or visit our online tool at [knaufinsulation.co.uk/uvalue-calculator](http://knaufinsulation.co.uk/uvalue-calculator)**

For written U-value calculations, please email details of your full construction build-up to [technical.uk@knaufinsulation.com](mailto:technical.uk@knaufinsulation.com) and we will respond accordingly to meet your requirements.



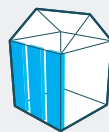
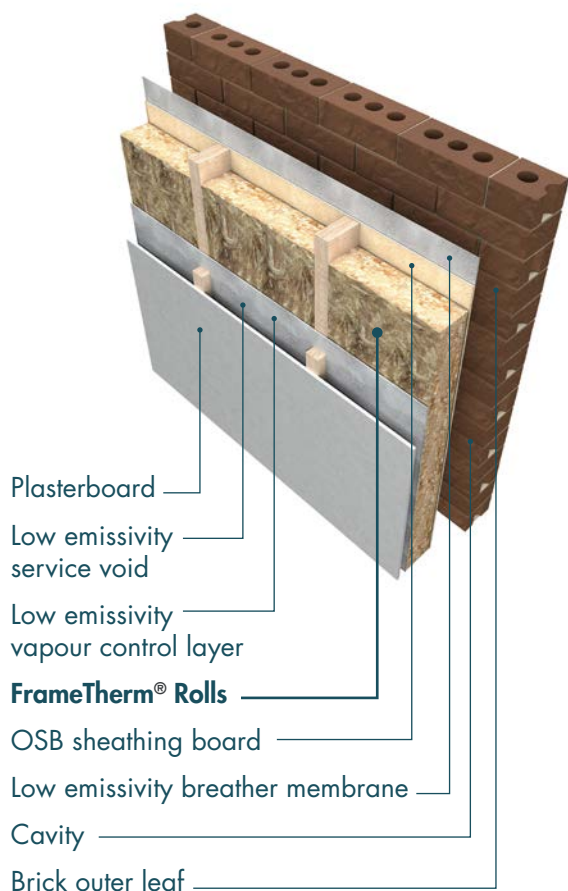

### APPLICATION OVERVIEW

Mineral Wool rolls or slabs are friction-fitted between timber studs, with a low emissivity vapour control layer and a low emissivity service void being used to further enhance thermal performance.

Timber frame walls generally provide better levels of thermal insulation performance than masonry walls of comparable thickness. However, the reduced mass of the wall means that insulation materials need to provide a higher level of acoustic performance to compensate.

Our non-combustible solutions for timber frame buildings are designed to friction fit between studs to minimise heat loss, whilst also providing acoustic absorption to enhance the overall acoustic performance of the wall.

### RECOMMENDED PRODUCT

- **FrameTherm® Rolls** (see page 88)

### OTHER SUITABLE PRODUCTS

- **FrameTherm® Slab 32** (see page 100)
- **OmniFit® Slab 35** (see page 104)
- **Rocksilk® RS45** (see page 116)
- **Rocksilk® Flexible Slab** (see page 118)

### WHY MINERAL WOOL?

- Mineral Wool provides the best combination of thermal, fire safety and acoustic performance.
- Mineral Wool is easier to install correctly than other insulants such as rigid boards because it adapts to any slight imperfections in the substrate and knits together, eliminating any air gaps. Evidence shows the absence of air gaps is crucial to achieving real performance in the relevant application.



## TYPICAL U-VALUES

### USING FRAMETHERM® ROLLS BETWEEN TIMBER FRAMED WALLS WITH A LOW E SERVICE VOID AND CAVITY

Stud thickness (mm)	Product used	U-value (W/m <sup>2</sup> K)	
		Masonry outer leaf (Cavity Unventilated)	Tile / timber clad outer leaf (Cavity Ventilated)
140	FrameTherm® Roll 32	0.19	0.22
140	FrameTherm® Roll 35	0.20	0.23
140	FrameTherm® Roll 40	0.21	0.25
90	FrameTherm® Roll 32	0.25	0.30
90	FrameTherm® Roll 35	0.26	0.31
90	FrameTherm® Roll 40	0.27	0.33

Notes: Timber bridging is assumed as 15% and the stud depth is taken to be the same as the thickness of insulation specified. Thermal conductivity of timber studs is 0.12W/mK. Ventilated low emissivity airspace assumed to increase the R-value of the cavity to 0.29m<sup>2</sup>K/W and unventilated low emissivity airspace assumed to increase R-value of cavity to 0.77m<sup>2</sup>K/W. Knauf Insulated Plasterboard comprises 9.5mm plasterboard facing at 0.19W/mK where the remainder of the thickness is insulation with thermal conductivity of 0.023W/mK.

Please refer to specific national building regulations with respect to reaction to fire when selecting materials for use in external walls of buildings, restrictions apply to building of certain heights.

For any U-value calculations for alternative construction build-ups, please contact our Technical Support Team on 01744 766 666 or visit our online tool at [knaufinsulation.co.uk/uvalue-calculator](http://knaufinsulation.co.uk/uvalue-calculator)

For written U-value calculations, please email details of your full construction build-up to [technical.uk@knaufinsulation.com](mailto:technical.uk@knaufinsulation.com) and we will respond accordingly to meet your requirements.

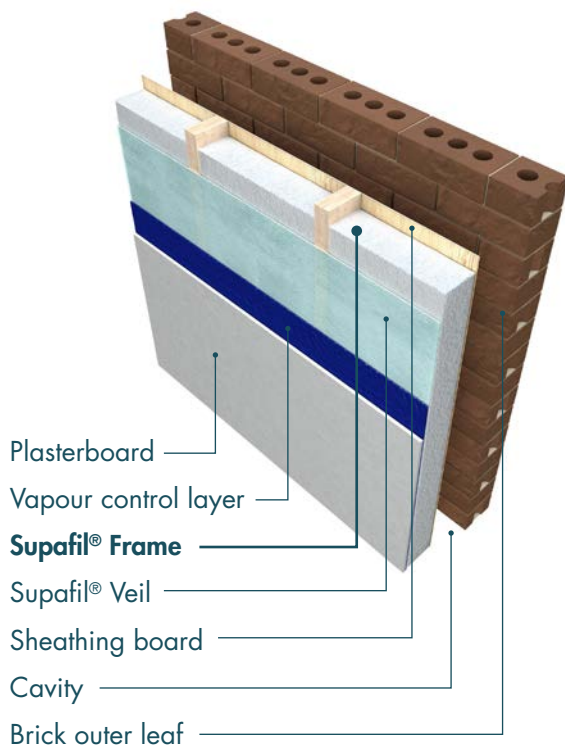

### APPLICATION OVERVIEW

Insulation is blown between timber studs and held in place by a veil layer, with the option to install additional insulation to the interior face of the wall and / or by partially filling the external cavity to further enhance thermal performance.

Timber frame walls generally provide better levels of thermal insulation performance than masonry walls of comparable thickness. However, the reduced mass of the wall means that insulation materials need to provide a higher level of acoustic performance to compensate.

Our non-combustible blown-in solutions for timber frame buildings are designed to friction fit between studs to minimise heat loss, whilst also providing acoustic absorption to enhance the overall acoustic performance of the wall.

### WHY MINERAL WOOL?

- Mineral Wool provides the best combination of thermal, fire safety and acoustic performance.
- Mineral Wool is easier to install correctly than other insulants such as rigid boards because it adapts to any slight imperfections in the substrate and knits together, eliminating any air gaps. Evidence shows the absence of air gaps is crucial to achieving real performance in the relevant application.

### RECOMMENDED PRODUCT

- **Supafil® Frame** (see page 112)





## TYPICAL U-VALUES

### USING SUPAFIL® FRAME BETWEEN TIMBER STUDS

Stud thickness (mm)	Vapour permeable membrane	U-value (W/m <sup>2</sup> K)	
		Standard clay brick outer leaf (0.77W/mK)	Tile / timber clad outer leaf
200	Standard	0.20	0.22
140	Standard	0.27	0.29
200	Low E	0.17	0.21
140	Low E	0.23	0.28

Low E membrane used in the above calculations = Protect TF200 Thermo. U-values calculated assuming Supafil Frame installed density of 30kg/m<sup>3</sup> and having thermal conductivity of 0.033W/mK.

### SUPAFIL® FRAME CONDUCTIVITY

THE THERMAL CONDUCTIVITY OF SUPAFIL® FRAME IS DEPENDENT ON APPLICATION AND INSTALLED DENSITY.

Application	Angle range (°)	Installed density (kg/m <sup>3</sup> )	Thermal conductivity (W/mK)
Enclosed rafter spaces and timber frame stud walls	0-90	30.0	0.033
	0-90	26.0	0.034
	0-90	23.0	0.036
Enclosed rafter spaces	0-25	19.0	0.038

For any U-value calculations for alternative construction build-ups, please contact our Technical Support Team on 01744 766 666 or visit our online tool at [knaufinsulation.co.uk/uvalue-calculator](https://knaufinsulation.co.uk/uvalue-calculator)

For written U-value calculations, please email details of your full construction build-up to [technical.uk@knaufinsulation.com](mailto:technical.uk@knaufinsulation.com) and we will respond accordingly to meet your requirements.

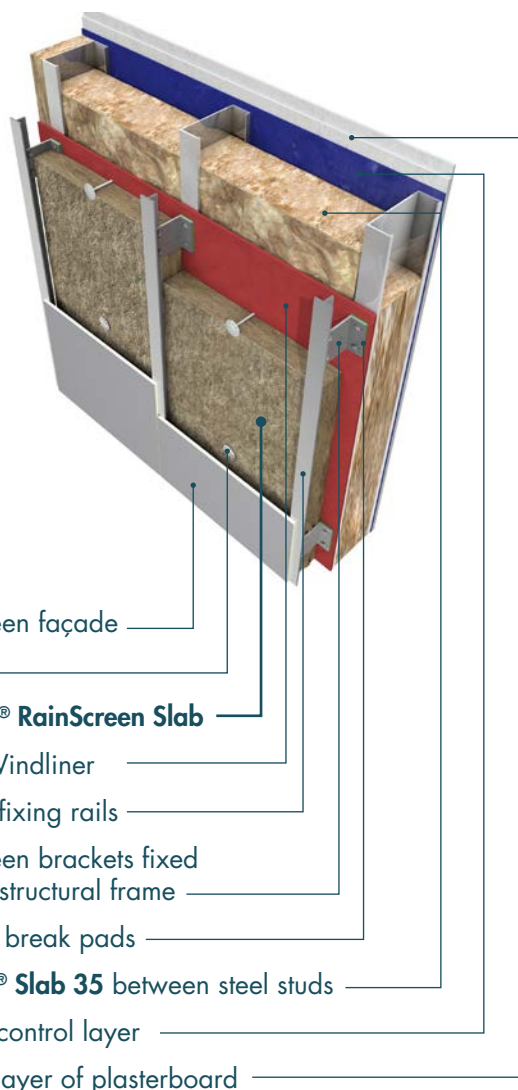

Rainscreen façade

Fixings

**Rock silk® RainScreen Slab**

Knauf Windliner

Vertical fixing rails

Rainscreen brackets fixed  
back to structural frame

Thermal break pads

**OmniFit® Slab 35** between steel studs

Vapour control layer

Double layer of plasterboard



### APPLICATION OVERVIEW

Rainscreen Façade Systems are lightweight when compared to brick and masonry solutions and can provide the designer with a wide range of aesthetic options.

In addition to thermal performance, fire performance of insulation materials is a crucial consideration, particularly when designing buildings in accordance with Building Regulations or when the building is to have high occupancy levels or be used by vulnerable occupants.

Our Mineral Wool insulation solutions provide the required thermal and fire performance and can be installed on buildings of any height.

### RECOMMENDED PRODUCTS

(In external rainscreen zone)

- **Rock silk® RainScreen Slab** (see page 114)



(Between light steel frame studwork)

- **OmniFit® Slab 35** (see page 104)

### OTHER SUITABLE PRODUCTS

(between light steel frame studwork)

- **OmniFit® Roll 34** (see page 102)
- **Rock silk® RS45** (see page 116)
- **Rock silk® Flexible Slab** (see page 118)

### WHY MINERAL WOOL?

- Mineral Wool provides the best combination of thermal, fire safety and acoustic performance.
- Compliance with reaction to fire classification requirements in Building Regulations without the need for system testing or desktop studies.



## TYPICAL U-VALUES

### USING ROCKSILK® RAINSCREEN SLAB

Rocksilk® RainScreen Slab (mm)	U-value (W/m <sup>2</sup> K)				
	OmniFit® Slab 35 thickness between light steel frame stud inner leaf			Dense block inner leaf λ1.130	Reinforced Concrete λ2.300
	90mm	100mm	150mm	100mm	200mm
250	0.16	0.16	0.15	0.22	0.23
210	0.17	0.17	0.16	0.25	0.25
200	0.18	0.17	0.16	0.25	0.26
180	0.19	0.18	0.17	0.27	0.28
150	0.20	0.20	0.19	0.35	-
120	0.24	0.23	0.21	-	-
100	0.24	0.23	0.23	-	-
75	0.27	0.26	0.23	-	-
50	0.31	0.30	0.26	-	-

Notes: The above are based on an aluminium helping hand brackets with base dimensions 75 x 62mm sat on a 5mm PVC thermal break pad, bracket is 5mm thick, aluminium bracket length to give 50mm residual cavity. Brackets set at 600 x 600mm centres fixed to structure. Dense block as λ=1.13, steelwork as 2mm with 50mm flange at 600 x 600mm centres infilled with OmniFit® Slab 35. Internal lining is standard 2 x 12.5mm wall board, cement particle sheathing board. Cavity is fully ventilated.

**The above values are for guidance only, please contact our Technical Support Team direct for specific values – all of our calculations for Rainscreen Façade Systems are carried out to BS EN 10211 using compliant software.**

We provide FREE 3D U-value calculations for Rainscreen Façade Systems.

Contact our Technical Support Team for details on 01744 766 666 or [technical.uk@knaufinsulation.com](mailto:technical.uk@knaufinsulation.com)

### DID YOU KNOW THAT ROCKSILK® RAINSCREEN SLAB AND OMNIFIT® SLAB 35 ARE SPECIFIED IN THE KNAUF THROUGHWALL SYSTEM?

The Knauf ThroughWall system is designed to meet required building performance while allowing a flexibility of external finishes to be applied, such as rainscreen cladding and brickwork.

For full information on the system performance, installation method and standard details visit [knauf.co.uk/systems-and-products/systems/exterior-systems/throughwall-system](http://knauf.co.uk/systems-and-products/systems/exterior-systems/throughwall-system)

### AVAILABLE INSULATION CPD COURSE

## NON-COMBUSTIBLE INSULATION SOLUTIONS FOR RAINSCREEN FAÇADE SYSTEMS

The CPD includes the following topics:

- Fire regulations related to Rainscreen Façade Systems
- Considerations for buildings over 18m in height
- Your options as a designer to achieve compliance and minimise risk

Visit [knaufinsulation.co.uk/technical-support/cpd](http://knaufinsulation.co.uk/technical-support/cpd) to book your CPD today!

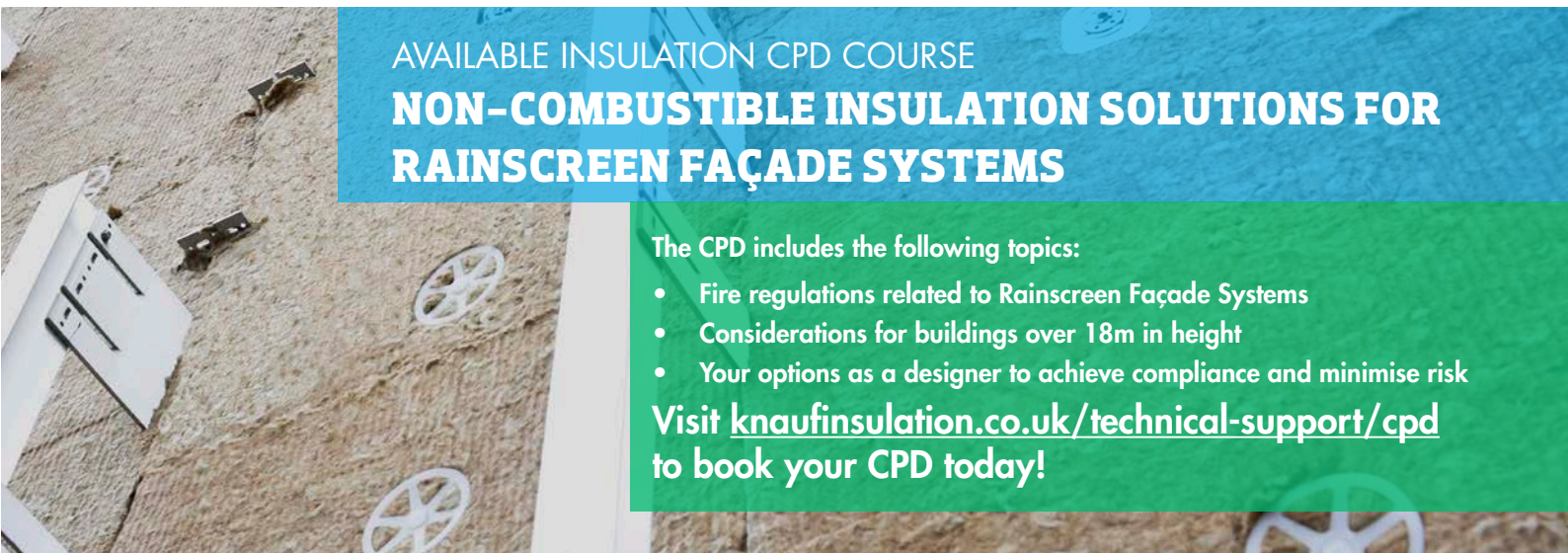



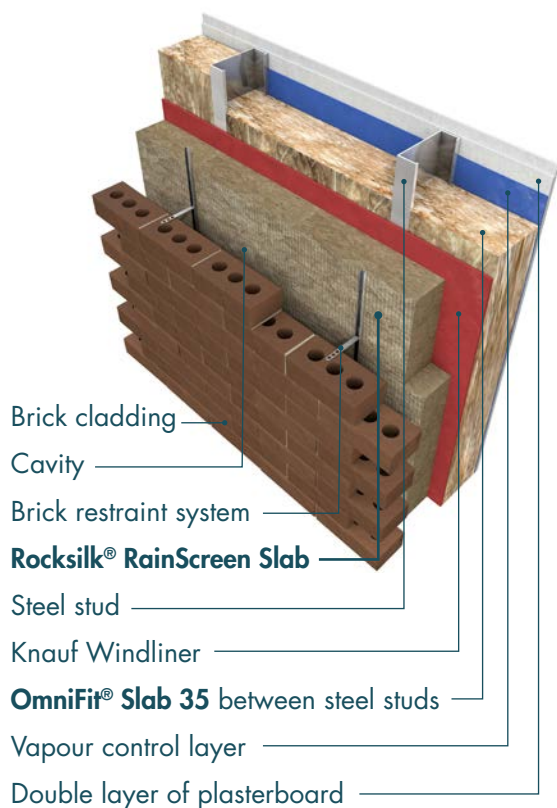

### APPLICATION OVERVIEW

A partial fill cavity features thermal insulation secured to the inner steel or timber framing system, leaving a cavity of air between the insulation and the masonry outer leaf.

The cavity between the insulation and the outer leaf performs as a barrier to external moisture, preventing it from tracking to the inner construction.

In addition to thermal properties, fire performance of insulation materials is a crucial consideration, when the building is to have high occupancy levels or have vulnerable occupants.

Our Mineral Wool insulation solutions provide the required thermal and fire performance and can be installed on buildings of any height.

### RECOMMENDED PRODUCTS

(In external rainscreen zone)

- **Rock silk® RainScreen Slab** (see page 114)



(Between light steel frame studwork)

- **OmniFit® Slab 35** (see page 104)

### OTHER SUITABLE PRODUCTS

(between light steel frame studwork)

- **OmniFit® Roll 34** (see page 102)
- **Rock silk® RS45** (see page 116)
- **Rock silk® Flexible Slab** (see page 118)

### WHY MINERAL WOOL?

- Mineral Wool provides the best combination of thermal, fire safety and acoustic performance.
- Compliance with reaction to fire classification requirements in Building Regulations without the need for system testing or desktop studies.

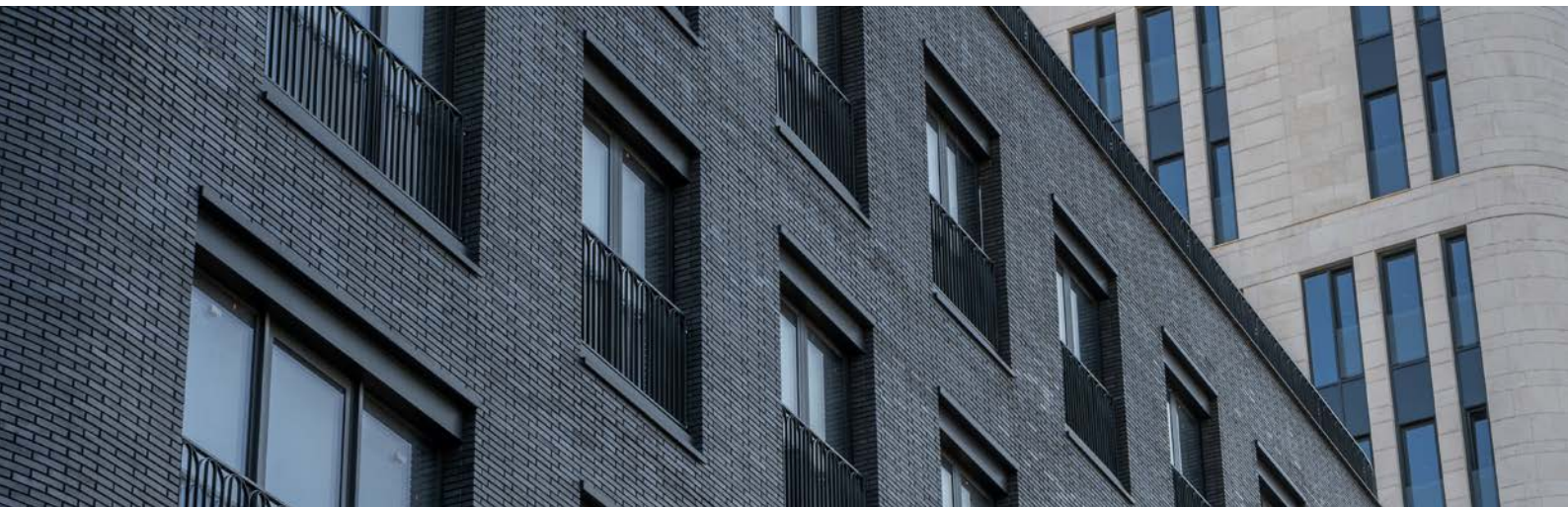

## TYPICAL U-VALUES

**FOR PARTIALLY FILLED MASONRY CAVITIES – NEW– USING ROCKSILK® RAINSCREEN SLAB  
(BRICK OUTER LEAF / CAVITY / 100MM INNER LEAF AS DETAILED BELOW)**

Rocksilk® RainScreen Slab (mm)	U-value (W/m²K)							
	102.5mm Brick K=0.770		100mm Dense Block K=1.210		100mm Medium Dense Block K=0.510		102.5mm Aircrete Block K=0.150	
	100mm SFS	150mm SFS	100mm SFS	150mm SFS	100mm SFS	150mm SFS	100mm SFS	150mm SFS
250	0.10	0.10	0.10	0.10	0.10	0.09	0.10	0.09
210	0.12	0.11	0.12	0.11	0.12	0.11	0.11	0.10
200	0.12	0.11	0.12	0.11	0.12	0.11	0.12	0.11
180	0.13	0.12	0.13	0.12	0.13	0.12	0.12	0.11
150	0.15	0.13	0.15	0.13	0.15	0.13	0.14	0.12
120	0.17	0.15	0.17	0.15	0.17	0.15	0.16	0.14
100	0.19	0.16	0.19	0.16	0.19	0.16	0.17	0.15
75	0.21	0.19	0.21	0.19	0.21	0.19	0.19	0.17
50	0.26	0.23	0.26	0.23	0.25	0.22	0.21	0.20

Note: 1.2mm Gauge SFS at 600mm centres, fully filled with OmniFi® Slab 35 (0.035W/mK). 12mm cementitious sheathing board and 2x1.5mm wallboard internal finish. Rocksilk® Rainscreen Slab (0.034W/mK) installed with 50mm residual cavity using ACS 25/15 Framefix restraint system secured with stainless steel fixings.

The above values are for guidance only, please contact our Technical Support Team direct for specific values.

We provide FREE 3D U-value calculations for Rainscreen Façade Systems.

Contact our Technical Support Team for details on 01744 766 666 or [technical.uk@knaufinsulation.com](mailto:technical.uk@knaufinsulation.com)

### DID YOU KNOW THAT ROCKSILK® RAINSCREEN SLAB AND OMNIFIT® SLAB 35 ARE SPECIFIED IN THE KNAUF THROUGHWALL SYSTEM?

The Knauf ThroughWall system is designed to meet required building performance while allowing a flexibility of external finishes to be applied, such as rainscreen cladding and brickwork.

For full information on the system performance, installation method and standard details visit [knauf.co.uk/systems-and-products/systems/exterior-systems/throughwall-system](http://knauf.co.uk/systems-and-products/systems/exterior-systems/throughwall-system)

AVAILABLE INSULATION CPD COURSE

## NON-COMBUSTIBLE INSULATION SOLUTIONS FOR RAINSCREEN FAÇADE SYSTEMS

The CPD includes the following topics:

- Fire regulations related to Rainscreen Façade Systems
- Considerations for buildings over 18m in height
- Your options as a designer to achieve compliance and minimise risk

Visit [knaufinsulation.co.uk/technical-support/cpd](http://knaufinsulation.co.uk/technical-support/cpd) to book your CPD today!





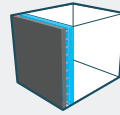
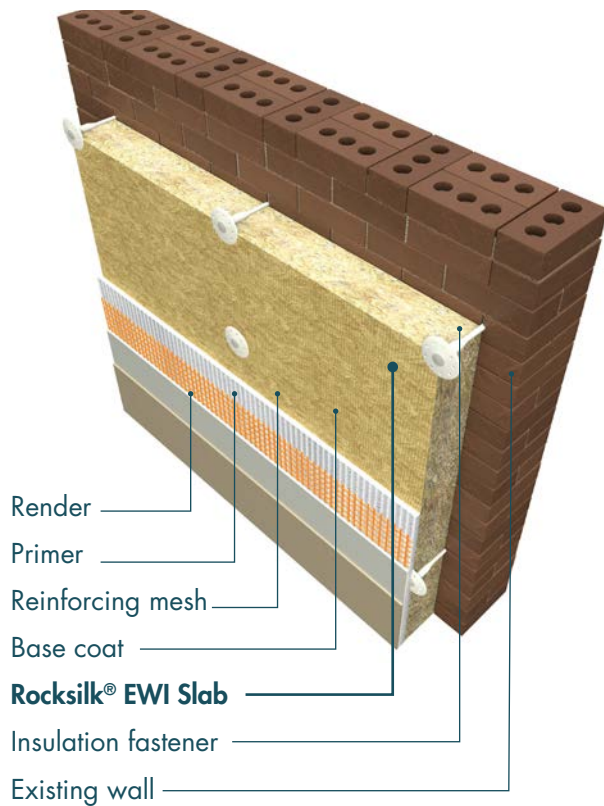

### APPLICATION OVERVIEW

External wall insulation involves the installation of an insulating layer to the external fabric of an existing or new building and is usually finished with a render coat.

Important issues when specifying an external wall insulation solution include the level of thermal performance to be achieved, which finish is the most suitable and the reaction to fire classification of the insulation.

Our Rock Mineral Wool insulation for external wall provides thermal and acoustic performance as well as being non-combustible.

### RECOMMENDED PRODUCT

- **Rocksilksl® EWI Slab** (see page 128)

### WHY MINERAL WOOL?

- Mineral Wool provides the best combination of thermal, fire safety and acoustic performance.
- Using a breathable Mineral Wool solution allows moisture vapour to pass through the construction to outside, removing the risk of condensation.





## TYPICAL U-VALUES

### USING ROCKSILK® EWI SLAB - REFURBISHMENT

Thickness (mm)	U-value (W/m <sup>2</sup> K)	
	225mm solid brick wall (0.77 W/mK)	215mm solid block wall (0.45 W/mK)
200*	0.17	0.16
180*	0.18	0.18
160*	0.20	0.20
140*	0.23	0.22
120	0.26	0.25
100	0.31	0.29

\*Thicknesses above 120mm are bespoke and subject to availability and minimum order quantities. Contact us for more details.

### USING ROCKSILK® EWI SLAB - NEW BUILD

Thickness (mm)	U-value (W/m <sup>2</sup> K)		
	215mm solid block wall (0.34 W/mK)	215mm solid block wall (0.19 W/mK)	215mm solid block wall (0.16 W/mK)
200*	0.16	0.15	0.14
180*	0.17	0.16	0.15
160*	0.19	0.17	0.17
140*	0.21	0.19	0.19
120	0.24	0.22	0.21
100	0.28	0.25	0.23

\*Thicknesses above 120mm are bespoke and subject to availability and minimum order quantities. Contact us for more details.

For any U-value calculations for alternative construction build-ups, please contact our Technical Support Team on 01744 766 666 or visit our online tool at [knaufinsulation.co.uk/uvalue-calculator](https://knaufinsulation.co.uk/uvalue-calculator)

For written U-value calculations, please email details of your full construction build-up to [technical.uk@knaufinsulation.com](mailto:technical.uk@knaufinsulation.com) and we will respond accordingly to meet your requirements.



External profiled sheeting

Rail and bracket

**FactoryClad Roll 40**

Vapour control layer

Liner sheet

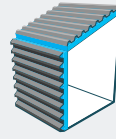

### APPLICATION OVERVIEW

Built-up metal wall systems typically consist of a low profile metal inner liner sheet, separated from an outer, higher profile metal weather sheet and are typically assembled on site.

The cavity between them is filled with a layer of insulation to provide the specified level of thermal performance. As well as thermal performance acoustic performance is also important.

Our Mineral Wool insulation solutions for built-up metal walls provide excellent levels of sound absorption, reducing the drumming effect of rainwater on walls and improving the overall acoustic performance of the wall.

### RECOMMENDED PRODUCT

- **FactoryClad Roll 40** (see page 86)

### OTHER SUITABLE PRODUCT

- **FactoryClad Roll 32** (see page 86)

### WHY MINERAL WOOL?

- Mineral Wool provides the best combination of thermal, fire safety and acoustic performance.
- Mineral Wool is easier to install correctly than other insulants such as rigid boards because it adapts to any slight imperfections in the substrate and knits together, eliminating any air gaps. Evidence shows the absence of air gaps is crucial to achieving real performance in the relevant application.



## TYPICAL U-VALUES

### U-VALUES WITH RAILS AT 1.20m SPACINGS

#### USING FACTORYCLAD ROLL 40

Thickness (mm)	U-value (W/m <sup>2</sup> K)
	Rails at 1.20m spacings
220	0.21
200	0.22
180	0.25
160	0.28
140	0.32

*Note: Generic rail and bracket U-value calculations can be provided by our Technical Support Team, however, for proprietary rail and bracket systems and all standing seam systems, the system manufacturer should be consulted for project specific U-value calculations.*

#### USING FACTORYCLAD ROLL 32

Thickness (mm)	U-value (W/m <sup>2</sup> K)
	Rails at 1.20m spacings
160 (2x80)	0.22

*Note: Generic rail and bracket U-value calculations can be provided by our Technical Support Team, however, for proprietary rail and bracket systems and all standing seam systems, the system manufacturer should be consulted for project specific U-value calculations.*

NOTE: The above tables should be used for guidance only.

Due to the complex nature of heat flow through these systems (due to the way they are assembled) it is not possible to calculate U-values using the normal simplified methods.

Our Technical Support Team can calculate the specification of insulation needed to achieve specific U-values (including the effect of thermal bridging for simple rail and bracket systems) but normally one would consult the system manufacturer, which is also the case for standing seam systems.



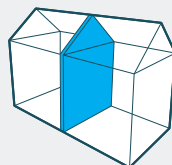
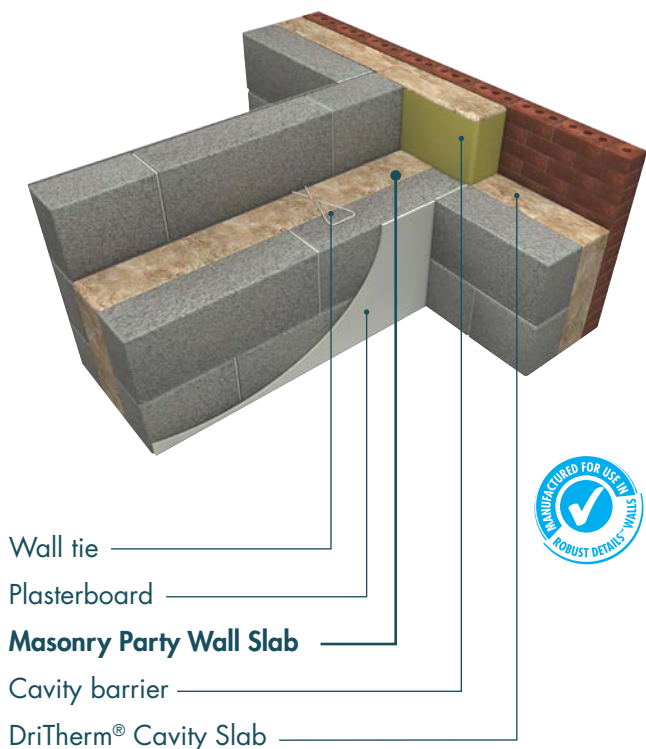

### APPLICATION OVERVIEW

Full-fill built-in insulation solutions are installed as the walls are built, with slabs being friction-fitted between the inner and outer leaves of the wall and in between wall ties.

Insulation is required to prevent heat loss via convection by fully filling the cavity to prevent an unwanted chimney effect, in addition to sound reduction to prevent noise transferring between dwellings.

Our non-combustible insulation solutions for party walls allow a zero-effective U-value to be claimed in SAP and are compliant with a wide range of constructions included in the Robust Details Handbook to demonstrate high levels of acoustic performance.

### WHY MINERAL WOOL?

- Mineral Wool provides the best combination of thermal, fire safety and acoustic performance.
- Mineral Wool is easier to install correctly than other insulants such as rigid boards because it adapts to any slight imperfections in the substrate and knits together, eliminating any air gaps. Evidence shows the absence of air gaps is crucial to achieving real performance in the relevant application.

### RECOMMENDED PRODUCT (MASONRY)

- **Masonry Party Wall Slab** (see page 96)

### RECOMMENDED PRODUCT (TIMBER FRAME)

- **Timber Frame Party Wall Slab** (see page 98)

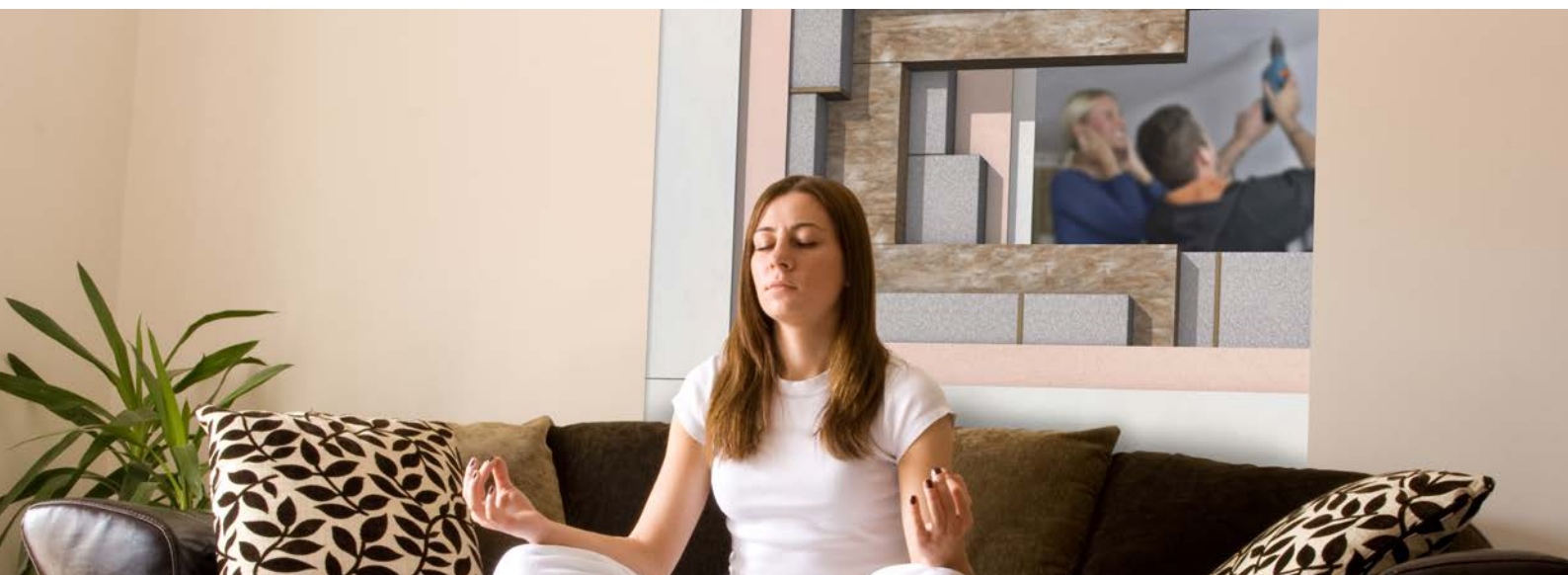

## TYPICAL U-VALUES

## USING SEPARATING (PARTY) WALL - BUILT-IN

U-value (W/m <sup>2</sup> K)	Party Wall Construction
0.0*	Solid
0.5	Unfilled cavity with no effective edge sealing
0.2	Unfilled cavity with effective edge sealing around all exposed edges and in line with insulation layers in abutting elements
<b>0.0*</b>	Fully filled cavity (e.g. by using <b>Masonry Party Wall Slab</b> or <b>Timber Frame Party Wall Slab</b> ) and with effective edge sealing around all exposed edges and in line with insulation layers in abutting elements

\* By either building a solid wall or fully filling a party wall cavity with mineral wool insulation results in a U-value of 0.0 W/m<sup>2</sup>K, i.e. zero heat loss.

## TIMBER FRAME (PARTY) SEPARATING WALL BUILD-UP

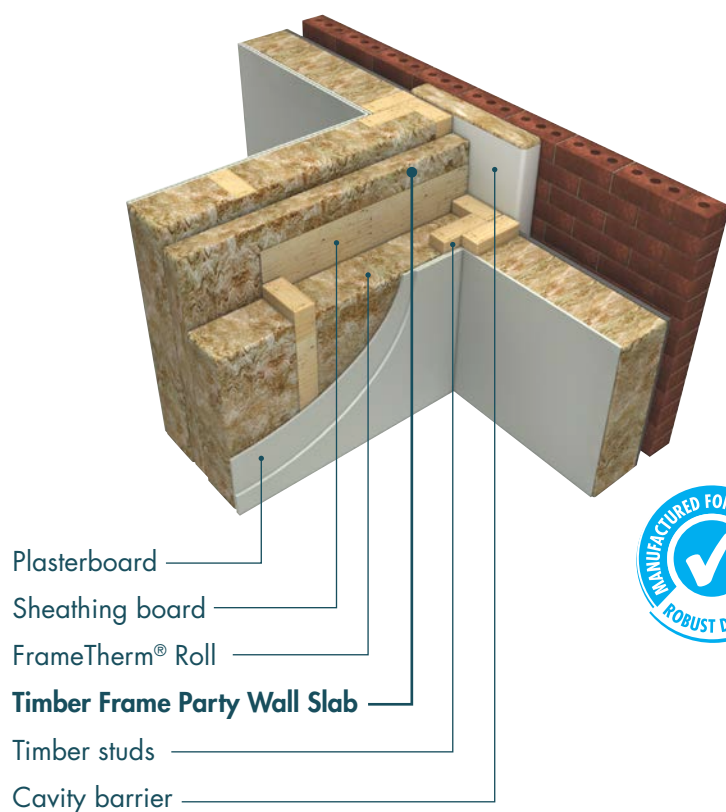

See tables on page 97 (masonry) / page 99 (timber frame) for compatibility with Robust Detail walls

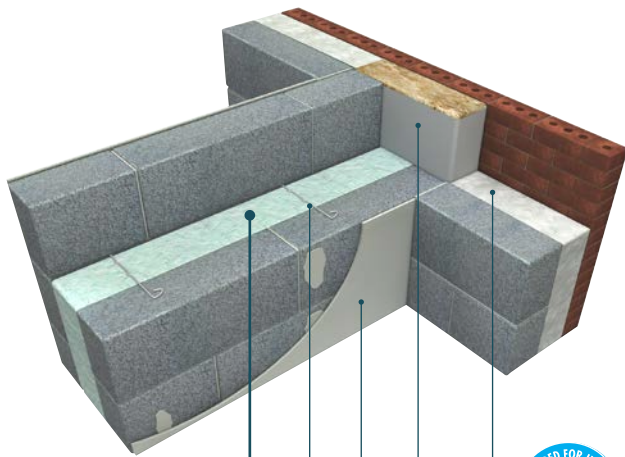

#### Supafil® Party Wall

Wall tie

Plasterboard on dabs

Cavity barrier

Supafil® 34

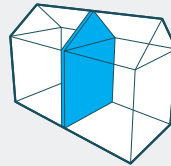

#### APPLICATION OVERVIEW

New build full-fill blown-in insulation solutions are installed via a series of pre-drilled installation holes by approved technicians once walls are built and when the building is watertight.

Insulation is required to prevent heat loss via convection by fully filling the cavity to prevent an unwanted chimney effect, in addition to sound reduction to prevent noise transferring between dwellings.

Our non-combustible Supafil® Party Wall system allows a zero-effective U-value to be claimed in SAP and is compliant walls built to constructions included in the Robust Details Handbook to demonstrate high levels of acoustic performance.

#### RECOMMENDED PRODUCT

- **Supafil® Party Wall** (masonry only) (see page 110)

#### WHY MINERAL WOOL?

- Mineral Wool provides the best combination of thermal, fire safety and acoustic performance.
- Mineral Wool is easier to install correctly than other insulants such as rigid boards because it adapts to any slight imperfections in the substrate and knits together, eliminating any air gaps. Evidence shows the absence of air gaps is crucial to achieving real performance in the relevant application.





## TYPICAL U-VALUES

### USING SEPARATING (PARTY) WALL - BLOWN-IN

U-value (W/m <sup>2</sup> K)	Party Wall Construction
0.0*	Solid
0.5	Unfilled cavity with no effective edge sealing
0.2	Unfilled cavity with effective edge sealing around all exposed edges and in line with insulation layers in abutting elements
<b>0.0*</b>	Fully filled cavity (e.g. by using <b>Supafil® Party Wall</b> ), and with effective edge sealing around all exposed edges and in line with insulation layers in abutting elements

\*By either building a solid wall or fully filling a party wall cavity with mineral wool insulation results in a U-value of 0.0 W/m<sup>2</sup>K, i.e. zero heat loss.

### Robust Detail Separating Walls and Party Wall Bypass Solutions - Supafil® Party Wall

Robust Detail Wall Type	Minimum Cavity Width (mm)	Block Type	Block Density (kg/m <sup>3</sup> )	Wall Finish	Parge coat	Zero U-value
E-WM-1	75	Dense	1850 to 2300	Wet plaster	Yes	Yes
E-WM-2	75	Light aggregate	1350 to 1600	Wet plaster	Yes	Yes
E-WM-3	75	Dense	1850 to 2300	Plasterboard (8kg/m <sup>2</sup> ) on dabs	Yes	Yes
E-WM-4	75	Light aggregate	1350 to 1600	Plasterboard (8kg/m <sup>2</sup> ) on dabs	Yes	Yes
E-WM-5	75	Besblock 'Star Performer'	1528	Plasterboard (8kg/m <sup>2</sup> ) on dabs on cement render	Yes	Yes
E-WM-6	75	Aircrete	600 to 800	Plasterboard (8kg/m <sup>2</sup> ) on dabs on cement render	Yes	Yes
E-WM-10	75	Aircrete - thin joint	600 to 800	Plasterboard (8kg/m <sup>2</sup> ) on dabs on cement render	Yes	Yes
E-WM-11	100	Light aggregate (or nominated hollow or cellular blocks)	1350 to 1600	Plasterboard (8kg/m <sup>2</sup> ) on dabs	Yes	Yes
E-WM-12	75	Plasmor Aglite Ultima	1050	Plasterboard (8kg/m <sup>2</sup> ) on dabs	Yes	Yes
E-WM-13	75	Aircrete - thin joint	600 to 800	Plasterboard (8kg/m <sup>2</sup> ) on dabs on cement render	Yes	Yes
E-WM-16	100	Dense	1850 to 2300	Plasterboard (9.6kg/m <sup>2</sup> ) on dabs	Yes	Yes
E-WM-18	100	Dense	1850 to 2300	Wet plaster	Yes	Yes
E-WM-19	100	Dense or light aggregate (or nominated hollow or cellular blocks)	1350 to 1600 or 1850 to 2300	Plasterboard on dabs on cement render	Yes	Yes
E-WM-21	100	Light aggregate	1350 to 1600	Wet plaster	Yes	Yes
E-WM-26	100	Besblock 'Star Performer'	1528	Plasterboard (10kg/m <sup>2</sup> ) on dabs	No	Yes
E-WM-28	100	Light aggregate	1350 to 1600	Plasterboard (8kg/m <sup>2</sup> ) on dabs	No	Yes
E-WM-30	100	Aircrete - standard and thin joint	600 to 800	Plasterboard (8kg/m <sup>2</sup> ) on dabs	No	Yes
E-WM-31	100	H+H - Celcon Elements - thin joint	575	Plasterboard (8kg/m <sup>2</sup> ) on dabs	No	Yes

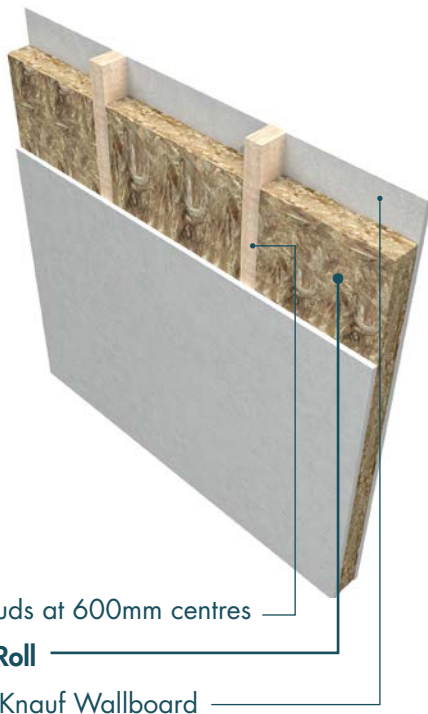

### APPLICATION OVERVIEW

Acoustic insulation is installed between two leaves of plasterboard. Variables within the system can include the type of plasterboard used, the types of studwork used and the orientation of studwork, all of which can be varied to provide differing levels of performance.

In addition to high levels of mass which is provided by the plasterboard layers, absorbent insulation is used to improve the sound reduction properties of internal walls. In certain buildings there may also be specific fire resistance requirements for walls between specific room types.

Our non-combustible solutions for internal walls provide the high levels of absorption required to contribute to excellent levels of sound reduction, and can also help towards high levels of fire resistance where required.

### WHY MINERAL WOOL?

- Mineral Wool provides the best combination of thermal, fire safety and acoustic performance.
- Mineral Wool insulation is the most effective insulant at reducing sound transmission and reverberations. The fibre matrix encourages the absorption of sound waves, converting them into heat energy, where other insulation types simply let the sound pass through.

### RECOMMENDED PRODUCT

- **Acoustic Roll** (see page 92)

### OTHER SUITABLE PRODUCTS

- **OmniFit® Slab 35** (see page 104)
- **Rocksilk® RS45** (see page 116)
- **Rocksilk® Flexible Slab** (see page 118)



## SOUND INSULATION PERFORMANCE



### TIMBER STUD PARTITIONS

Stud Size (mm)	Facing	Thickness of insulation (mm)	Sound insulation (R <sub>w</sub> dB)
63x38	12.5mm standard plasterboard each side	None	35
63x38	12.5mm standard plasterboard each side	50mm Acoustic Roll	40
63x38	12.5mm Knauf Soundshield each side	50mm Acoustic Roll	44



### METAL STUD PARTITIONS

Stud type	Stud spacing (mm)	Facing	Thickness of insulation (mm)	Sound insulation (R <sub>w</sub> dB)
50mm C stud	600 c/s	12.5mm Knauf Wallboard each side	25mm Acoustic Roll	43
70mm C stud	600 c/s	15mm Knauf Fireshield each side	25mm Acoustic Roll	49
50mm C stud	600 c/s	2 layers of 12.5mm Knauf Soundshield each side	25mm Acoustic Roll	54
70mm C stud	600 c/s	2 layers of 12.5mm Knauf Fireshield each side	50mm Acoustic Roll	54



### STAGGERED METAL STUD PARTITIONS

Stud type	Channel size	Facing	Thickness of insulation (mm)	Sound insulation (R <sub>w</sub> dB)
60mm T stud	72mm	2 layers of 12.5mm Knauf Soundshield each side	50mm Acoustic Roll	57
92mm T stud	148mm	2 layers of 15mm Knauf Soundshield each side	50mm Acoustic Roll	62



### TWIN METAL STUD PARTITIONS

Stud type	Facing	Thickness of insulation (mm)	Sound insulation (R <sub>w</sub> dB)
92mm C stud	19mm Knauf Plank and two layers of 12.5mm Wallboard each side	100mm Acoustic Roll	69
146mm C stud	19mm Knauf Plank and two layers of 12.5mm Wallboard each side	100mm Acoustic Roll	74



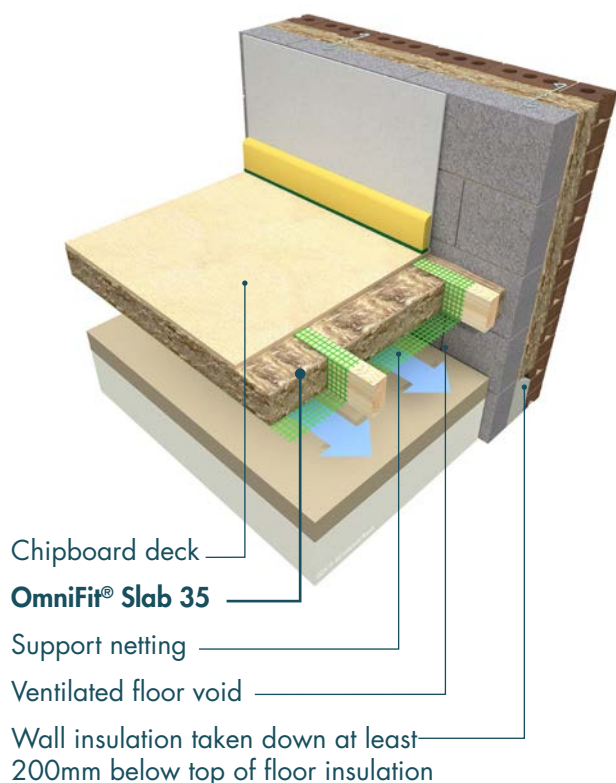

### APPLICATION OVERVIEW

In a suspended timber ground floor, insulation is placed between the joists and supported on netting (e.g. polypropylene) or timber battens.

In this application, an important consideration is the thermal and acoustic performance of the insulation.

Our Mineral Wool insulation solutions for suspended timber ground floors ensure that the product used fills all gaps between joists to prevent air movement which can lead to unwanted heat loss.

### RECOMMENDED PRODUCTS

(installed from below)

- **OmniFit® Slab 35** (see page 104)
- **Rocksilk® Flexible Slab** (see page 118)

(installed from above)

- **OmniFit® Roll 40** (see page 102)

### OTHER SUITABLE PRODUCTS

- **OmniFit® Roll 34** (see page 102)
- **Rocksilk® RS45** (see page 116)

### WHY MINERAL WOOL?

- Mineral Wool provides the best combination of thermal, fire safety and acoustic performance.
- Mineral Wool is easier to install correctly than other insulants such as rigid boards because it adapts to any slight imperfections in the substrate and knits together, eliminating any air gaps. Evidence shows the absence of air gaps is crucial to achieving real performance in the relevant application.



## TYPICAL U-VALUES

### USING OMNIFIT® SLAB 35 BETWEEN JOISTS

Floor joist thickness (mm)	U-value (W/m <sup>2</sup> K)							
	Ratio of perimeter to area (p/a) (m <sup>2</sup> )							
	0.1	0.2	0.3	0.4	0.5	0.6	0.7	0.8
250 (100+150mm)	0.10	0.12	0.13	0.13	0.13	0.14	0.14	0.14
200 (2x100mm)	0.11	0.14	0.15	0.15	0.16	0.16	0.16	0.17
150	0.13	0.16	0.18	0.19	0.20	0.20	0.20	0.21
100	0.15	0.20	0.23	0.24	0.26	0.26	0.27	0.28

Note: The U-values have been calculated assuming that the timber joists are 38mm wide at 600mm centres. Floor covering assumed 19mm chipboard.

### USING ROCKSILK® FLEXIBLE SLAB BETWEEN JOISTS

Floor joist thickness (mm)	U-value (W/m <sup>2</sup> K)							
	Ratio of perimeter to area (p/a) (m <sup>2</sup> )							
	0.1	0.2	0.3	0.4	0.5	0.6	0.7	0.8
250 (2x100+50mm)	0.10	0.12	0.13	0.14	0.15	0.14	0.14	0.14
200 (2x100mm)	0.12	0.14	0.15	0.16	0.16	0.17	0.17	0.17
150 (100+50mm)	0.13	0.17	0.18	0.20	0.20	0.21	0.21	0.21
100	0.16	0.21	0.23	0.25	0.26	0.27	0.28	0.28

Note: The U-values have been calculated assuming that the timber joists are 38mm wide at 600mm centres. Floor covering assumed 19mm chipboard.

### USING OMNIFIT® ROLL 40 BETWEEN JOISTS

Floor joist thickness (mm)	U-value (W/m <sup>2</sup> K)							
	Ratio of perimeter to area (p/a) (m <sup>2</sup> )							
	0.1	0.2	0.3	0.4	0.5	0.6	0.7	0.8
250 (100+150mm)	0.11	0.13	0.14	0.14	0.15	0.15	0.15	0.15
200	0.12	0.15	0.16	0.17	0.17	0.18	0.18	0.18
150	0.14	0.17	0.19	0.20	0.21	0.22	0.22	0.23
100	0.16	0.21	0.24	0.26	0.27	0.28	0.29	0.30

Note: The U-values have been calculated assuming that the timber joists are 38mm wide at 600mm centres. Floor covering assumed 19mm chipboard.

For any U-value calculations for alternative construction build-ups, please contact our Technical Support Team on 01744 766 666 or visit our online tool at [knaufinsulation.co.uk/uvalue-calculator](http://knaufinsulation.co.uk/uvalue-calculator)

For written U-value calculations, please email details of your full construction build-up to [technical.uk@knaufinsulation.com](mailto:technical.uk@knaufinsulation.com) and we will respond accordingly to meet your requirements.



Mineral Wool insulation taken down at least 300mm below top of soffit insulation

**Rocksilk® Soffit Linerboard Standard**

Concrete slab

Floor screed

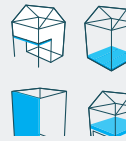

### APPLICATION OVERVIEW

If insulating below a structural floor, insulation can be fixed from below, allowing the floor to be insulated and finished in one process.

In timber frame exposed soffits, insulation is friction-fitted between timber joists, using the whole depth of the joist as an insulation zone. This allows high levels of thermal and acoustic insulation performance.

Our Rock Mineral Wool insulation solutions not only provide thermal and acoustic performance that would be required in an exposed soffit, but are also non-combustible giving additional peace of mind.

### RECOMMENDED PRODUCTS

- **Rocksilk® Soffit Linerboard Standard** (see page 122)
- **Rocksilk® Soffit Linerboard Extra** (see page 122)

### WHY MINERAL WOOL?

- Mineral Wool provides the best combination of thermal, fire safety and acoustic performance.





## TYPICAL U-VALUES

### USING ROCKSILK® SOFFIT LINERBOARD STANDARD TO AN EXPOSED SOFFIT.

Thickness (mm)	U-value (W/m <sup>2</sup> K)	
	Reinforced Concrete (RC) Floor Slab 150 - 300mm 2.500 (W/mK)	Precast plank 150mm 1.300 (W/mK)
295 (220+75)	0.12	0.12
270 (220+50)	0.13	0.13
220	0.15	0.15
185	0.18	0.18
160	0.21	0.20
130	0.25	0.25

Note: Calculated with 50mm Screed finish  $k=1.150$  and 1 steel fixing per slab.

### USING ROCKSILK® SOFFIT LINERBOARD EXTRA TO AN EXPOSED SOFFIT.

Thickness (mm)	U-value (W/m <sup>2</sup> K)	
	Reinforced Concrete (RC) Floor Slab 150 - 300mm 2.500 (W/mK)	Precast plank 150mm 1.300 (W/mK)
295 (220/6*+**75)	0.12	0.12
270 (220/6*+**50)	0.13	0.13
220/6*	0.15	0.15
185/6*	0.18	0.18
160/6*	0.21	0.20
130/6*	0.25	0.24

Note: Calculated with 50mm Screed finish  $k=1.150$  and 1 steel fixing per slab. Thermal conductivity of facing board = 0.240 W/mK.  
\* The /  $\delta$  is for the cement fibre flat sheet \*\*denotes standard product.

For any U-value calculations for alternative construction build-ups, please contact our Technical Support Team on 01744 766 666 or visit our online tool at [knaufinsulation.co.uk/uvalue-calculator](https://knaufinsulation.co.uk/uvalue-calculator)

For written U-value calculations, please email details of your full construction build-up to [technical.uk@knaufinsulation.com](mailto:technical.uk@knaufinsulation.com) and we will respond accordingly to meet your requirements.

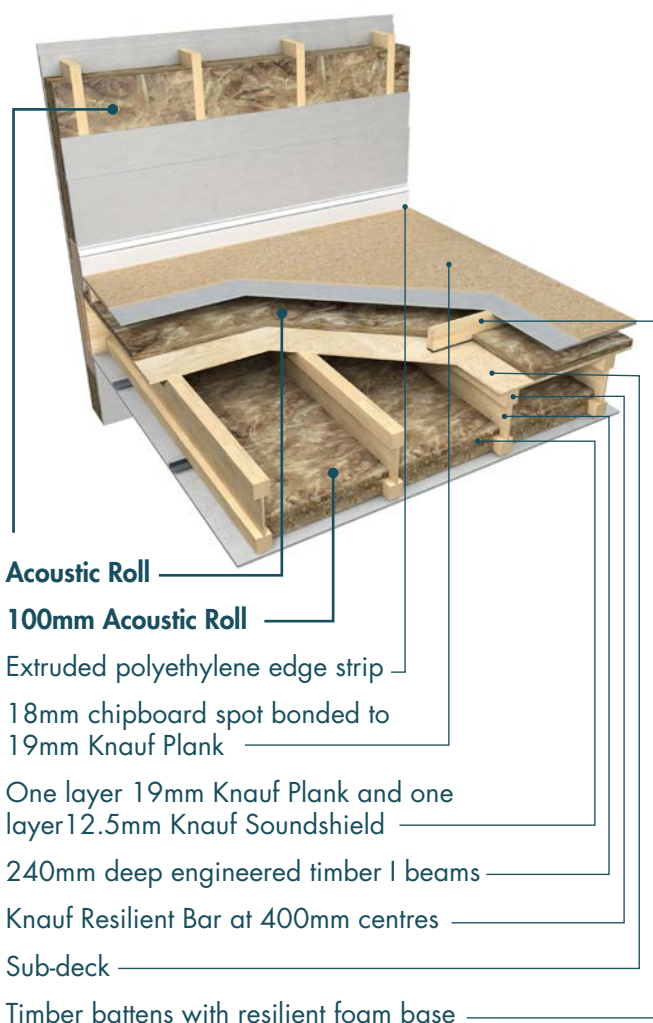

### APPLICATION OVERVIEW

Acoustic performance is the principle requirement in separating floors, with both sound insulation and sound absorption being important considerations.

The sound absorption characteristics of our Mineral Wool insulation solutions make them ideal for use in separating floor build-ups.

We have a wide range of solutions which comply with constructions registered in the Robust Details Handbook, providing compliance with sound related building regulations.

### RECOMMENDED PRODUCT

- **Acoustic Roll** (see page 92)

### OTHER SUITABLE PRODUCTS

- **OmniFir® Roll 40** (see page 102)
- **OmniFir® Slab 35** (see page 104)
- **Rocksilk® Flexible Slab** (see page 118)

### WHY MINERAL WOOL?

- Mineral Wool provides the best combination of thermal, fire safety and acoustic performance.
- Mineral Wool insulation is the most effective insulant at reducing sound transmission and reverberations. The fibre matrix encourages the absorption of sound waves, converting them into heat energy, where other insulation types simply let the sound pass through.

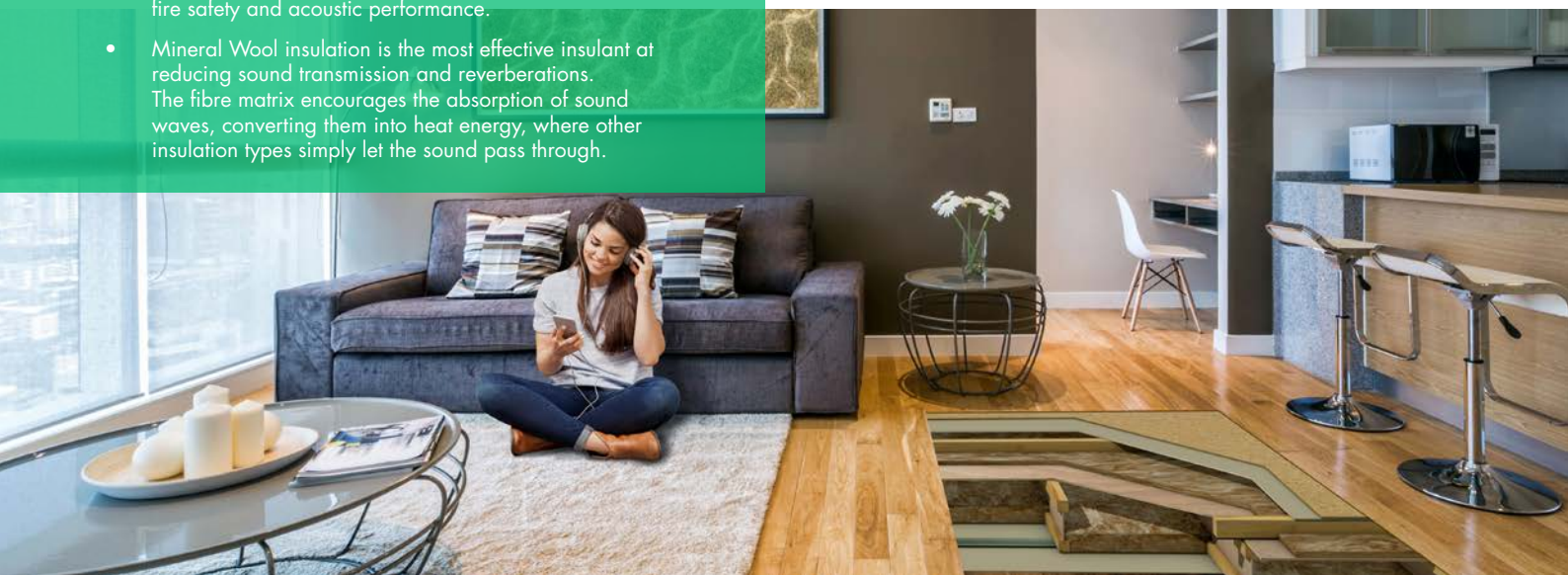

## ROBUST DETAILS



	Robust Detail Handbook reference	Joist Type	Acoustic Roll	OmniFit® Roll 40	OmniFit® Slab 35	Rocksilk® Flexible Slab
Timber Separating Floors	E-FT-1	Timber I-joists	✓	✓	✓	✓
	E-FT-2	Timber solid joists	✓	✓	✓	✓
	E-FT-3	Timber flange and metal web joists	✓	✓	✓	✓
	E-FT-4	Finnforest SoundBar Systems	✓	✓	✓	✓
	E-FT-5	Timber I-joists	✓	✓	✓	✓
	E-FT-6	Timber flange and metal web joists	✓	✓	✓	✓
	E-FT-7	Timber I-joists	✓	✓	✓	✓
	E-FT-8	Timber solid joists	✓	✓	✓	✓



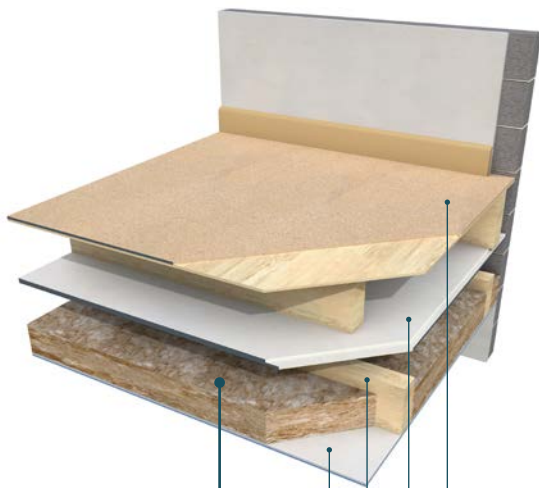

#### Acoustic Roll

Two layers of plasterboard  
min 20kg/m<sup>2</sup>

New independent joists

Existing ceiling upgraded  
to 20kg/m<sup>2</sup>

Hardboard fixed to  
existing timber floor



#### APPLICATION OVERVIEW

This detail provides a solution to upgrade existing separating floors for improved acoustic performance. The existing timber joist floor is overlaid with hardboard and a new independent timber joist ceiling containing absorbent Mineral Wool is installed below.

The separation between the existing floor and the new ceiling prevents unwanted noise transfer via flanking, whilst the use of absorbent Mineral Wool further improves sound reduction.

#### RECOMMENDED PRODUCT

- **Acoustic Roll** (see page 92)

#### OTHER SUITABLE PRODUCTS

- **OmniFit® Roll 40** (see page 102)
- **OmniFit® Slab 35** (see page 104)
- **Rocksilk® RS45** (see page 116)
- **Rocksilk® Flexible Slab** (see page 118)

#### WHY MINERAL WOOL?

- Mineral Wool provides the best combination of thermal, fire safety and acoustic performance.
- Mineral Wool insulation is the most effective insulant at reducing sound transmission and reverberations. The fibre matrix encourages the absorption of sound waves, converting them into heat energy, where other insulation types simply let the sound pass through.

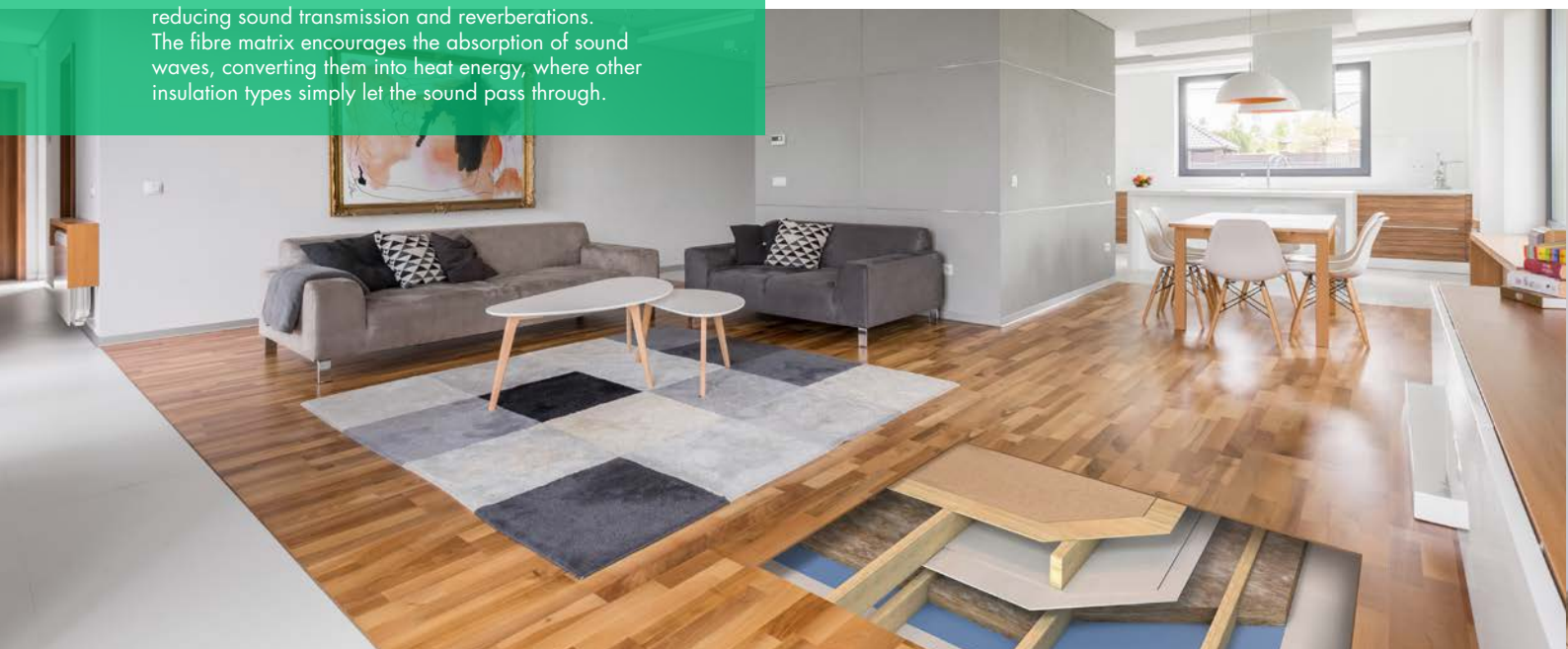

## SEPARATING FLOORS

UPGRADE TO AN EXISTING TIMBER FLOOR WITH  
NEW PLATFORM FLOOR



**Rocksilksil® Acoustic Floor Slab**

Plasterboard at least 10kg/m<sup>2</sup>

Timber deck with minimum  
mass of 15kg/m<sup>2</sup>

Timber joists



### APPLICATION OVERVIEW

This detail provides a solution to upgrade existing separating floors for improved acoustic performance. The existing timber joist floor is overlaid with a new floating platform (min 25kg/m<sup>2</sup>) on a resilient layer of 25mm Rocksilksil® Acoustic Floor Slab.

The use of absorbent Mineral Wool improves sound reduction, provides a solution as recommended for floor treatment 2 in Approved Document E and is for use where flats are formed by material change of use.

### RECOMMENDED PRODUCTS

- **Rocksilksil® Acoustic Floor Slab** (see page 120)
- **Acoustic Roll** (see page 92)

### OTHER SUITABLE PRODUCTS

- **OmniFit® Roll 40** (see page 102)
- **OmniFit® Slab 35** (see page 104)
- **Rocksilksil® RS45** (see page 116)
- **Rocksilksil® Flexible Slab** (see page 118)





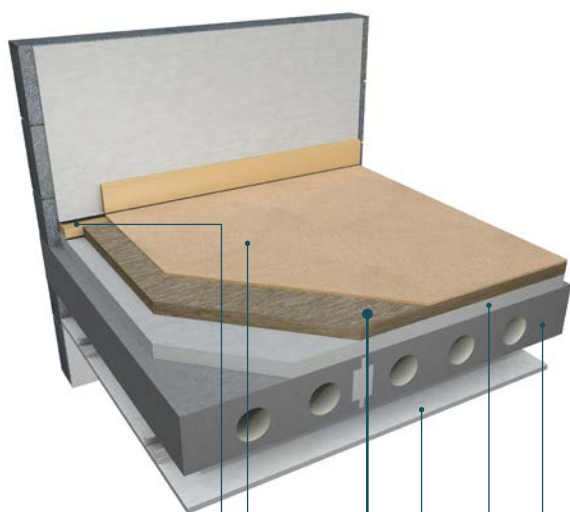

Extruded polyethylene edge strip

18mm chipboard

### Rocksilk® Acoustic Floor Slab Plus

15mm plasterboard supported by Knauf C Form II Ceiling System, minimum 75mm separation

40mm (min) screed directly applied to plank cement/sand or proprietary screed nominal 80 kg/m<sup>2</sup> mass per unit area

Minimum 150mm precast concrete slab (minimum 300kg/m<sup>2</sup> mass)



### APPLICATION OVERVIEW

Acoustic performance is the principle requirement in separating floors, with both sound insulation and sound absorption being important considerations.

The sound absorption characteristics of our Mineral Wool insulation solutions make them ideal for use in separating floor build-ups.

We have a wide range of solutions which comply with constructions registered in the Robust Details Handbook, providing compliance with sound related building regulations.

### RECOMMENDED PRODUCT

- **Rocksilk® Acoustic Floor Slab Plus** (see page 120)



### ROBUST DETAILS

	Robust Detail Handbook reference	Acoustic Floor Slab Plus
Concrete Floors	E-FC-1	✓
	E-FC-2	✓
Steel concrete composite floors	E-FS-1	✓

### WHY MINERAL WOOL?

- Mineral Wool provides the best combination of thermal, fire safety and acoustic performance.
- Mineral Wool insulation is the most effective insulant at reducing sound transmission and reverberations. The fibre matrix encourages the absorption of sound waves, converting them into heat energy, where other insulation types simply let the sound pass through.







### 100mm Acoustic Roll

Plasterboard at least 10kg/m<sup>2</sup>

Timber deck with minimum mass of 15kg/m<sup>2</sup>

Timber or steel joists



### APPLICATION OVERVIEW

Acoustic performance is the principle requirement for internal floors, with both sound insulation and sound absorption being important considerations.

The sound absorption characteristics of our Mineral Wool insulation solutions make them ideal for use in internal floor build-ups.

We have a wide range of solutions which comply with sound related building regulations.

### RECOMMENDED PRODUCT

- **Acoustic Roll** (see page 92)

### OTHER SUITABLE PRODUCTS

- **OmniFit® Roll 40** (see page 102)
- **OmniFit® Slab 35** (see page 104)
- **Rocksilk® RS45** (see page 116)
- **Rocksilk® Flexible Slab** (see page 118)



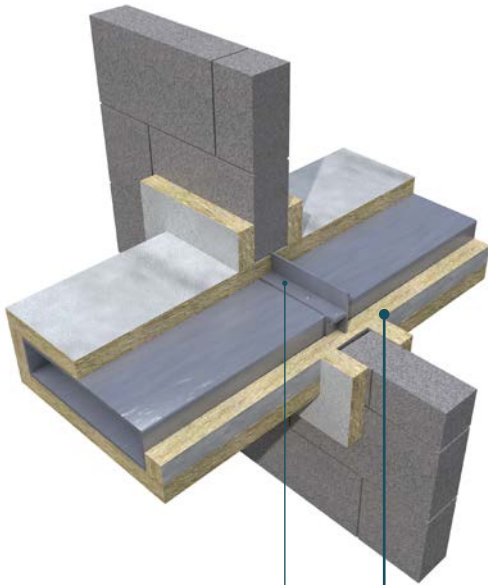

Steel angle riveted at  
150mm centres

**Fire-teK BD 917** fixed to duct  
and glued to wall and insulation

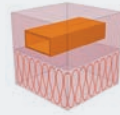

### APPLICATION OVERVIEW

In accordance with building regulations, when ductwork passes through any element of construction which has a designated period of fire resistance, the integrity of that compartment should be maintained.

Our Rock Mineral Wool fire protection solutions are designed to protect vertical and horizontal, rectangular and square steel ductwork associated with ventilation and/or air conditioning systems, in addition to ducted supply and extract systems (whether through ducts or plenums), mechanically assisted systems and those relying on natural convection.

### RECOMMENDED PRODUCT

- **Fire-teK BD 917** (see page 132)

### WHY MINERAL WOOL?

- Mineral Wool provides the best combination of thermal, fire safety and acoustic performance.
- With a melting point in excess of 1000°C, Rock Mineral Wool can provide up to two hours fire protection to steel ductwork.



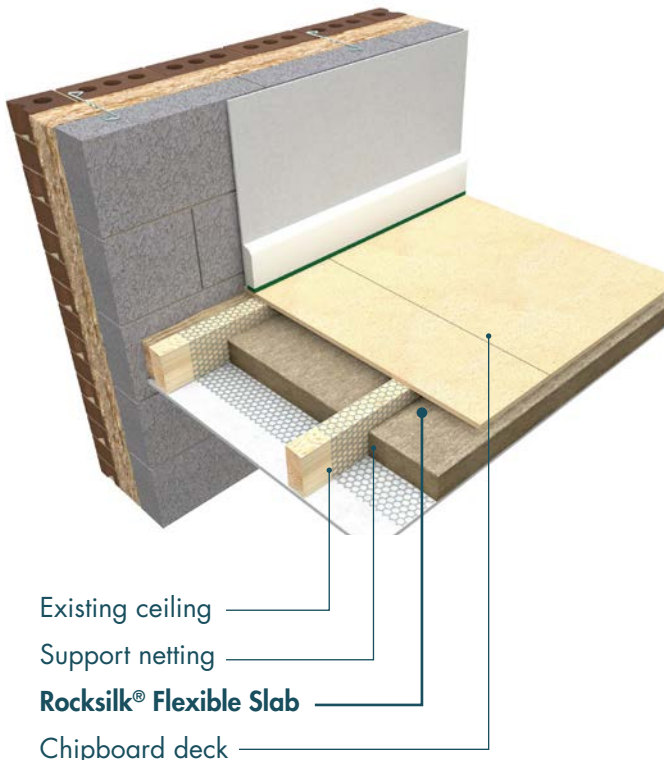

### APPLICATION OVERVIEW

When the loft of a two-storey house is converted into habitable accommodation, the floor to the new rooms must have 30 minutes fire resistance over any part of the escape route directly below. This can be achieved by completely refreshing the ceiling or by retaining the existing ceiling and insulating the joists with insulation that achieves the fire resistance period.

For this reason, fire performance of an insulation solution in this application is a crucial consideration, as the insulation must provide its own fire resistance period if the existing ceiling is to be retained.

Our Rock Mineral Wool solution is tested to meet the required fire resistance period as well as providing excellent acoustic properties in this application.

### WHY MINERAL WOOL?

- Mineral Wool provides the best combination of thermal, fire safety and acoustic performance.

### RECOMMENDED PRODUCT

- **Rocksilks® Flexible Slab** (see page 118)

**Rocksilks® Flexible Slab** is tested to provide

**60 minutes**

fire resistance in loft conversion floors.





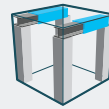
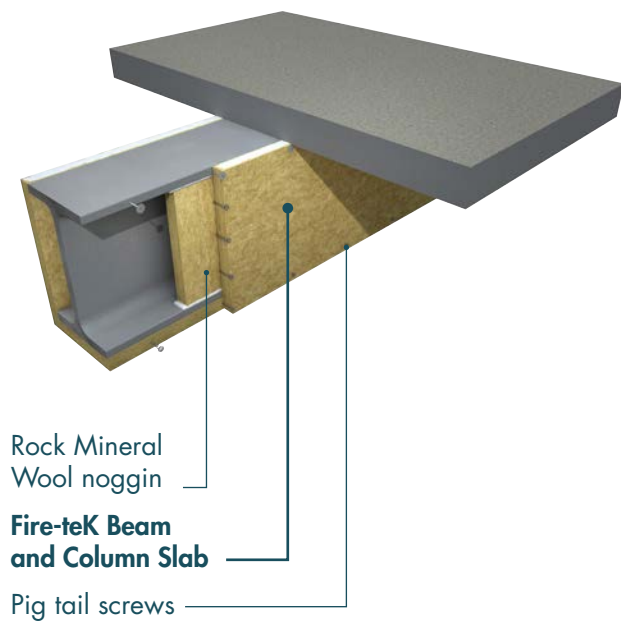

### APPLICATION OVERVIEW

With the increasing use of structural steel in construction, designers need fire protection solutions that provide a combination of fast installation and cost-effectiveness whilst achieving the desired finish.

Our Rock Mineral Wool fire protection solutions are designed to protect the steel from the heat of a fire. This delays the loss of structural integrity and the possible collapse of the building, allowing extra time for both the occupants to escape and fire services to tackle the fire.

### RECOMMENDED PRODUCT

- **Fire-teK Beam and Column Slab**  
(see page 130)

For more information see our  
Fire Protection of Structural Steel guide



### WHY MINERAL WOOL?

- Mineral Wool solutions manufactured to factory tolerances provide a consistent coverage across the whole surface, unlike painted solutions which can be difficult to check on-site.
- At less than half the weight of calcium silicate slabs, Mineral Wool solutions are easy to handle and fit, particularly for overhead work.



# PRODUCT SECTION

## CURED GLASS MINERAL WOOL

### Page Number

Loft Rolls	- 84 -
FactoryClad Rolls	- 86 -
FrameTherm® Rolls	- 88 -
Rafter Roll 32	- 90 -
Acoustic Roll	- 92 -
DriTherm® Cavity Slabs	- 94 -
Masonry Party Wall Slab	- 96 -
Timber Frame Party Wall Slab	- 98 -
FrameTherm® Slab 32	- 100 -
OmniFit® Roll 34	- 102 -
OmniFit® Roll 40	- 102 -
OmniFit® Slab 35	- 104 -

## BLOWN GLASS MINERAL WOOL

### Page Number

Supafil® 34	- 106 -
Supafil® 40	- 106 -
Supafil® CarbonPlus	- 108 -
Supafil® Party Wall	- 110 -
Supafil® Frame	- 112 -

## ROCK MINERAL WOOL

### Page Number

Rocksilk® RainScreen Slab	- 114 -
Rocksilk® Building Slabs	- 116 -
Rocksilk® Flexible Slab	- 118 -
Rocksilk® Acoustic Floor Slabs	- 120 -
Rocksilk® Soffit Linerboards	- 122 -
Rocksilk® Fabrication Slab	- 124 -
Rocksilk® Flat Roof Slabs	- 126 -
Rocksilk® EWI Slab	- 128 -
Fire-Tek Beam and Column Slabs	- 130 -
Fire-teK BD 917	- 132 -
UrbanScape® Green Roof System	- 134 -



### APPLICATION

- Pitched Roofs - Ceiling Level (see page 32)



## NON-COMBUSTIBLE INSULATION

### PRODUCT DESCRIPTION

Loft Rolls are Glass Mineral Wool rolls, designed for use in cold lofts where pitched roofs are insulated at ceiling level.

They are non-combustible with the best possible Euroclass A1 reaction to fire classification, and are manufactured using Knauf Insulation's unique bio-based binder, ECOSE® Technology.

### BENEFITS

- Available in combi-cut, ready cut and uncut formats giving a wide range of choice to suit specific install requirements.
- Manufactured in two different options; long lengths to allow quick and simple installation maximising efficiency, and shorter lengths for ease of handling on-site.
- Compression packed and lightweight for easy handling and moving around a site.
- Awarded the DECLARE 'Red List Free' label which means it is free of any harmful chemicals listed on the Living Building Challenge (LBC) Red List.

For the Feel Good Factor, use Knauf Insulation Mineral Wool with the added ECOSE® Technology benefits. See page 24 for further details.



### CERTIFICATION





## SPECIFICATIONS

### LOFT ROLL 40 (COMBI-CUT)

Thickness (mm)	Thermal conductivity (W/mK)	Thermal resistance (m <sup>2</sup> K/W)	Length (m)	Width (mm)	Area per pack (m <sup>2</sup> )	Rolls per pallet	Pallet product code
200	0.040	5.00	4.85	1140 (2x570/3x380)	5.529	24	2404169
150	0.040	3.75	7.53	1140 (2x570/3x380)	8.584	24	2404166
100	0.040	2.50	11.25	1140 (2x570/3x380)	12.825	24	2404167



### LOFT ROLL 44 (COMBI-CUT)

Thickness (mm)	Thermal conductivity (W/mK)	Thermal resistance (m <sup>2</sup> K/W)	Length (m)	Width (mm)	Area per pack (m <sup>2</sup> )	Rolls per pallet	Pallet product code
200	0.044	4.55	6.00	1140 (2x570/3x380)	6.840	24	715820
170	0.044	3.86	7.03	1140 (2x570/3x380)	8.014	24	2404156
150	0.044	3.41	8.05	1140 (2x570/3x380)	9.177	24	2404155
100	0.044	2.27	12.18	1140 (2x570/3x380)	13.885	24	2404154



### LOFT ROLL 44 (COMBI-CUT) SHORTER LENGTHS

Thickness (mm)	Thermal conductivity (W/mK)	Thermal resistance (m <sup>2</sup> K/W)	Length (m)	Width (mm)	Area per pack (m <sup>2</sup> )	Rolls per pallet	Pallet product code
200	0.044	4.50	3.40	1140 (2x570/3x380)	3.876	40	244329
170	0.044	3.85	4.30	1140 (2x570/3x380)	4.902	40	244328
150	0.044	3.40	4.90	1140 (2x570/3x380)	5.586	40	244327
100	0.044	2.25	7.28	1140 (2x570/3x380)	8.299	40	244326



### LOFT ROLL 44 (READY-CUT)

Thickness (mm)	Thermal conductivity (W/mK)	Thermal resistance (m <sup>2</sup> K/W)	Length (m)	Width (mm)	Area per pack (m <sup>2</sup> )	Rolls per pallet	Pallet product code
150	0.044	3.40	8.05	2x570	9.177	24	2404163
100	0.044	2.25	12.18	2x570	13.885	24	2404161



All dimensions are nominal

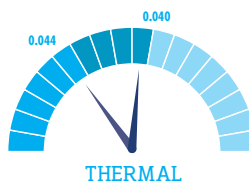

Fire: Euroclass reaction to fire classification | Sustainability: Generic BRE Green Guide rating

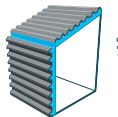

### APPLICATION

- Built-up Metal Roofs (see page 40)
- Built-up Metal Walls (see page 62)



**NON-COMBUSTIBLE  
INSULATION**

### PRODUCT DESCRIPTION

FactoryClad Rolls are Glass Mineral Wool rolls, designed for use in built-up metal roofs and walls, manufactured covering a range of thermal performances.

They are non-combustible with the best possible Euroclass A1 reaction to fire classification, and are manufactured using Knauf Insulation's unique bio-based binder, ECOSE® Technology.

### BENEFITS

- Manufactured in long lengths with high tear strength, for ease of installation and durability.
- Can be used as a sound absorbent lining in conjunction with perforated metal liner sheets to control reverberation of internal sound.
- Rolls are manufactured at 1200mm width to improve efficiency on site with quick installation.
- Awarded the DECLARE 'Red List Free' label which means it is free of any harmful chemicals listed on the Living Building Challenge (LBC) Red List.

For the Feel Good Factor, use Knauf Insulation Mineral Wool with the added ECOSE® Technology benefits. See page 24 for further details.



### CERTIFICATION



SPECIFICATIONS

FACTORYCLAD ROLL 32 (UNCUT)

Thickness (mm)	Thermal conductivity (W/mK)	Thermal resistance (m <sup>2</sup> K/W)	Length (m)	Width (mm)	Area per pack (m <sup>2</sup> )	Rolls per pallet	Pallet product code
80	0.032	2.50	5.00	1200	6.000	24	2400379



FACTORYCLAD ROLL 40 (UNCUT)

Thickness (mm)	Thermal conductivity (W/mK)	Thermal resistance (m <sup>2</sup> K/W)	Length (m)	Width (mm)	Area per pack (m <sup>2</sup> )	Rolls per pallet	Pallet product code
300	0.040	7.50	3.20	1200	3.840	24	612931
280	0.040	7.00	3.45	1200	4.140	24	612929
260	0.040	6.50	3.70	1200	4.440	24	2439994
240	0.040	6.00	4.70	1200	5.640	24	709932
220	0.040	5.50	4.35	1200	5.220	24	2411649
200	0.040	5.00	4.85	1200	5.820	24	2402003
180	0.040	4.50	6.26	1200	7.512	24	2402002
160	0.040	4.00	7.05	1200	8.460	24	2402001
140	0.040	3.50	8.02	1200	9.624	24	2402000
120	0.040	3.00	9.40	1200	11.280	24	2401999
100	0.040	2.50	11.25	1200	13.500	24	2401998
80	0.040	2.00	14.10	1200	16.920	24	2401997



All dimensions are nominal



Fire: Euroclass reaction to fire classification | Sustainability: Generic BRE Green Guide rating

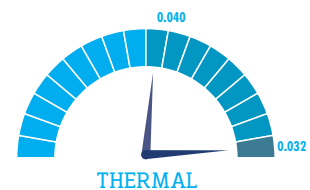
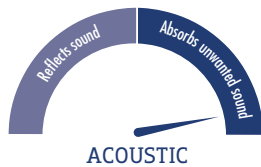



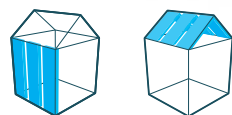

### APPLICATION

- Pitched Roofs - Rafter Level (see page 34)
- Timber Frame Walls - Built-in insulation between studs with partially filled cavity (see page 50)



**NON-COMBUSTIBLE  
INSULATION**

### PRODUCT DESCRIPTION

FrameTherm® Rolls are Glass Mineral Wool rolls, designed for use in timber frame applications between studwork, offering a range of thermal performance to meet construction requirements.

They are non-combustible with the best possible Euroclass A1 reaction to fire classification, and are manufactured using Knauf Insulation's unique bio-based binder, ECOSE® Technology.

### BENEFITS

- Designed to friction fit between timber studs, which prevents air movement and infiltration through or around the insulation, minimising heat loss.
- Ready-cut to allow quick and simple installation, maximising on-site efficiency when compared with alternative insulants.
- Rolls are fully cut into 2x570mm and 3x380mm to suit commonly used timber stud spacing.
- Awarded the DECLARE 'Red List Free' label which means it is free of any harmful chemicals listed on the Living Building Challenge (LBC) Red List.

For the Feel Good Factor, use Knauf Insulation Mineral Wool with the added ECOSE® Technology benefits. See page 24 for further details.



### CERTIFICATION



SPECIFICATIONS

FRAMETHERM® ROLL 32 (READY-CUT)

Thickness (mm)	Thermal conductivity (W/mK)	Thermal resistance (m <sup>2</sup> K/W)	Length (m)	Width (mm)	Area per pack (m <sup>2</sup> )	Rolls per pallet	Pallet product code
140	0.032	4.35	2.80	2x570	3.192	24	2435999
90	0.032	2.80	4.50	2x570	5.130	24	2402014
140	0.032	4.35	2.80	3x380	3.192	24	292208
90	0.032	2.80	4.50	3x380	5.130	24	605745



FRAMETHERM® ROLL 35 (READY-CUT)

Thickness (mm)	Thermal conductivity (W/mK)	Thermal resistance (m <sup>2</sup> K/W)	Length (m)	Width (mm)	Area per pack (m <sup>2</sup> )	Rolls per pallet	Pallet product code
140	0.035	4.00	3.90	2x570	4.446	24	2407395
90	0.035	2.55	6.00	2x570	6.840	24	2407396
140	0.035	4.00	3.90	3x380	4.446	24	605754
90	0.035	2.55	6.00	3x380	6.840	24	605752



FRAMETHERM® ROLL 40 (READY-CUT)

Thickness (mm)	Thermal conductivity (W/mK)	Thermal resistance (m <sup>2</sup> K/W)	Length (m)	Width (mm)	Area per pack (m <sup>2</sup> )	Rolls per pallet	Pallet product code
140	0.040	3.50	8.02	2x570	9.143	24	498560
90	0.040	2.25	12.50	2x570	14.250	24	498196



All dimensions are nominal.

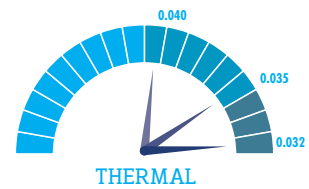
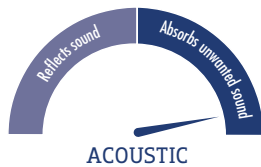

Fire: Euroclass reaction to fire classification | Sustainability: Generic BRE Green Guide rating



**NON-COMBUSTIBLE  
INSULATION**

### PRODUCT DESCRIPTION

Rafter Roll 32 is a Glass Mineral Wool roll, designed for use in warm roofs where the roof is insulated at rafter level, that offers excellent thermal performance.

It is non-combustible with the best possible Euroclass A1 reaction to fire classification, and is manufactured using Knauf Insulation's unique bio-based binder, ECOSE® Technology.

### BENEFITS

- Rolls are manufactured to allow cutting for installation at varying centre dimensions, providing maximum flexibility and on-site efficiency.
- High levels of sound absorption and reduction characteristics reduce unwanted external noise such as traffic or drumming from rainfall on the roof.
- Rolls are provided uncut in a width of 1200mm to allow cutting on-site to suit varying rafter dimensions.
- Awarded the DECLARE 'Red List Free' label which means it is free of any harmful chemicals listed on the Living Building Challenge (LBC) Red List.



### APPLICATION

- Pitched Roofs - Rafter Level (see page 34)

For the Feel Good Factor, use Knauf Insulation Mineral Wool with the added ECOSE® Technology benefits. See page 24 for further details.



### CERTIFICATION





SPECIFICATIONS

RAFTER ROLL 32 (UNCUT)

Thickness (mm)	Thermal conductivity (W/mK)	Thermal resistance (m <sup>2</sup> K/W)	Length (m)	Width (mm)	Area per pack (m <sup>2</sup> )	Rolls per pallet	Pallet product code
100	0.032	3.10	4.00	1200	4.800	24	2402020
75	0.032	2.30	5.25	1200	6.300	24	2402018



All dimensions are nominal.

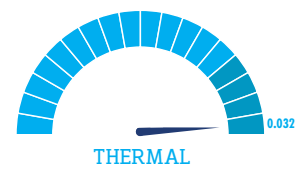
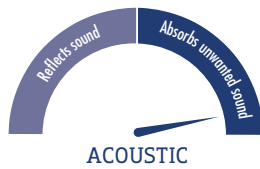

Fire: Euroclass reaction to fire classification | Sustainability: Generic BRE Green Guide rating



**NON-COMBUSTIBLE  
INSULATION**

### PRODUCT DESCRIPTION

Acoustic Roll is a Glass Mineral Wool roll, designed for use in internal wall and floor applications, to offer sound absorption and noise reduction properties.

It is non-combustible with the best possible Euroclass A1 reaction to fire classification, and is manufactured using Knauf Insulation's unique bio-based binder, ECOSE® Technology.

### BENEFITS

- Proven test results with all major brands of plasterboard to provide assured compliance with sound related building regulations.
- Manufactured density in excess of 10kg/m<sup>3</sup> meeting the requirements outlined within relevant sound related building regulations.
- Rolls are designed to fit between studs to close joints, reducing the potential for unwanted gaps and ensuring high levels of sound insulation.
- Awarded the DECLARE 'Red List Free' label which means it is free of any harmful chemicals listed on the Living Building Challenge (LBC) Red List.

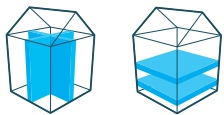

### APPLICATION

- Internal Walls (see page 68)
- Separating Floors - Timber (see page 74)
- Separating Floors - Upgrade to an existing timber floor with new ceiling (see page 76)
- Separating Floors - Upgrade to an existing timber floor with platform floor (see page 77)
- Internal Floors (see page 79)

For the Feel Good Factor, use Knauf Insulation Mineral Wool with the added ECOSE® Technology benefits. See page 24 for further details.



### CERTIFICATION



**SPECIFICATIONS**

ACOUSTIC ROLL (READY-CUT)						
Thickness (mm)	Length (m)	Width (mm)	Rolls per pack	Area per pack (m <sup>2</sup> )	Rolls per pallet	Pallet product code
100	10.30	2x600	1	12.360	24	715843
100	10.30	3x400	1	12.360	24	715842
75	14.50	2x600	1	17.400	24	715841
63	15.00	2x600	2	18.000	24	603550
50	13.50	2x600	1	16.200	24	715837
25	11.10	4x600	4	26.640	24	715838



All dimensions are nominal.

**Building regulations compliant**

Independent laboratory tested for proven use with major plasterboard brands.

- ✓ Knauf
- ✓ Siniat
- ✓ British Gypsum

Contact our Technical Support Team for details on **01744 766 666** or [technical.uk@knaufinsulation.com](mailto:technical.uk@knaufinsulation.com)

**Building regulations**

England and Wales: Approved Document E  
Northern Ireland: Technical Booklet G

All internal walls between a bedroom or room containing a WC and another room must provide a minimum sound insulation of 40 R<sub>w</sub> dB

**Building regulations**

Scotland: Section 5

All internal walls between a bedroom or room containing a WC and another room must provide a minimum sound insulation of 43 R<sub>w</sub> dB

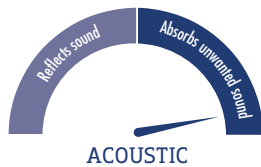
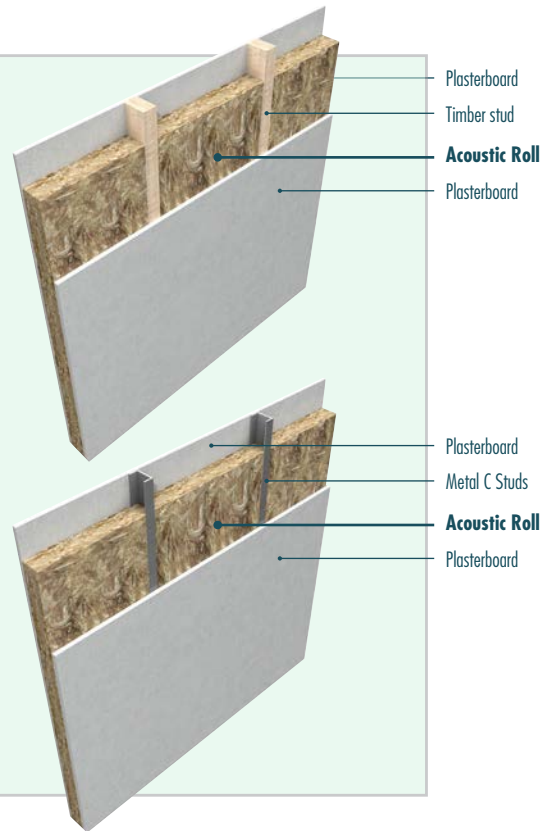

Fire: Euroclass reaction to fire classification | Sustainability: Generic BRE Green Guide rating





**NON-COMBUSTIBLE  
INSULATION**

### PRODUCT DESCRIPTION

DriTherm® Cavity Slabs are water-repellent Glass Mineral Wool slabs, designed for use in external full-fill masonry cavity walls, offering a range of thermal performance to suit construction requirements.

They are non-combustible with the best possible Euroclass A1 reaction to fire classification, and are manufactured using Knauf Insulation's unique bio-based binder, ECOSE® Technology.

### BENEFITS

- Water-repellent and BBA certified for use in all exposure zones, including those in very severe areas.
- Slabs are sized to fit between wall ties without the need for retaining discs.
- Cavity barriers are not required with non-combustible full-fill insulation, minimising the risk of fire spreading through a cavity.
- Awarded the DECLARE 'Red List Free' label which means it is free of any harmful chemicals listed on the Living Building Challenge (LBC) Red List.



### APPLICATION

- External Masonry Cavity Walls - Built-In (see page 44)



For the Feel Good Factor, use Knauf Insulation Mineral Wool with the added ECOSE® Technology benefits. See page 24 for further details.



### CERTIFICATION



## SPECIFICATIONS



### DRITHERM® CAVITY SLAB 32

Thickness (mm)	Thermal conductivity (W/mK)	Thermal resistance (m <sup>2</sup> K/W)	Length (mm)	Width (mm)	Slabs per pack	Area per pack (m <sup>2</sup> )	Packs per pallet	Pallet product code
150	0.032	4.65	1200	455	4	2.184	30	580216
125	0.032	3.91	1200	455	4	2.184	40	715828
100	0.032	3.13	1200	455	6	3.276	30	715829
85	0.032	2.66	1200	455	5	2.730	45	715830
75	0.032	2.34	1200	455	6	3.276	45	715827



### DRITHERM® CAVITY SLAB 34

Thickness (mm)	Thermal conductivity (W/mK)	Thermal resistance (m <sup>2</sup> K/W)	Length (mm)	Width (mm)	Slabs per pack	Area per pack (m <sup>2</sup> )	Packs per pallet	Pallet product code
150	0.034	4.41	1200	455	5	2.730	30	715834
125	0.034	3.68	1200	455	6	3.276	30	715836
100	0.034	2.94	1200	455	8	4.368	30	715832
75	0.034	2.21	1200	455	10	5.460	30	715833



### DRITHERM® CAVITY SLAB 37

Thickness (mm)	Thermal conductivity (W/mK)	Thermal resistance (m <sup>2</sup> K/W)	Length (mm)	Width (mm)	Slabs per pack	Area per pack (m <sup>2</sup> )	Packs per pallet	Pallet product code
150	0.037	4.05	1200	455	8	4.368	25	715835
125	0.037	3.35	1200	455	6	3.276	40	316660
100	0.037	2.70	1200	455	12	6.552	25	715831
85	0.037	2.25	1200	455	8	4.368	45	316656
75	0.037	2.00	1200	455	8	4.368	50	316654
65	0.037	1.80	1200	455	10	5.460	40	316652
50	0.037	1.40	1200	455	12	6.552	30	316650

All dimensions are nominal

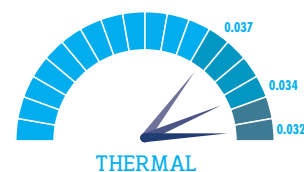
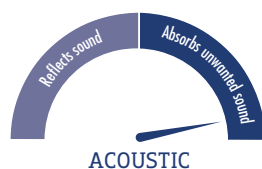

Fire: Euroclass reaction to fire classification | Sustainability: Generic BRE Green Guide rating



**NON-COMBUSTIBLE INSULATION**

### PRODUCT DESCRIPTION

Masonry Party Wall Slab is a Glass Mineral Wool slab, designed for use in masonry separating party walls, that offers thermal and acoustic performance.

It is non-combustible with the best possible Euroclass A1 reaction to fire classification, and is manufactured using Knauf Insulation's unique bio-based binder, ECOSE® Technology.

### BENEFITS

- Fully filling the party wall cavity contributes towards a zero effective U-value, simplifying compliance with building regulations.
- Suitable for use with a range of constructions registered in the Robust Details Handbook reducing the need for on-site acoustic testing.
- Awarded the DECLARE 'Red List Free' label which means it is free of any harmful chemicals listed on the Living Building Challenge (LBC) Red List.



### APPLICATION

- Separating (Party) Walls - Built-In (see page 64)

For the Feel Good Factor, use Knauf Insulation Mineral Wool with the added ECOSE® Technology benefits. See page 24 for further details.



### CERTIFICATION





## SPECIFICATIONS



### MASONRY PARTY WALL SLAB

Thickness (mm)	Density (kg/m <sup>3</sup> )	Length (mm)	Width (mm)	Slabs per pack	Area per pack (m <sup>2</sup> )	Packs per pallet	Pallet product code
100	18.00	1200	455	12	6.552	20	2441353
75	18.00	1200	455	16	8.736	20	2441351

All dimensions are nominal.

### ROBUST DETAIL SEPARATING WALLS AND PARTY WALL BYPASS SOLUTIONS - MASONRY PARTY WALL SLAB

Robust Detail Wall Type	Minimum Cavity Width (mm)	Block Type	Block Density (kg/m <sup>3</sup> )	Wall Finish	Parge coat	Zero U-value
E-WM-1	75	Dense	1850 to 2300	Wet plaster	Yes	Yes
E-WM-2	75	Light aggregate	1350 to 1600	Wet plaster	Yes	Yes
E-WM-3	75	Dense	1850 to 2300	Plasterboard (8kg/m <sup>2</sup> ) on dabs	Yes	Yes
E-WM-4	75	Light aggregate	1350 to 1600	Plasterboard (8kg/m <sup>2</sup> ) on dabs	Yes	Yes
E-WM-5	75	Besblock 'Star Performer'	1528	Plasterboard (8kg/m <sup>2</sup> ) on dabs on cement render	Yes	Yes
E-WM-6	75	Aircrete	600 to 800	Plasterboard (8kg/m <sup>2</sup> ) on dabs on cement render	Yes	Yes
E-WM-10	75	Aircrete - thin joint	600 to 800	Plasterboard (8kg/m <sup>2</sup> ) on dabs on cement render	Yes	Yes
E-WM-11	100	Light aggregate (or nominated hollow or cellular blocks)	1350 to 1600	Plasterboard (8kg/m <sup>2</sup> ) on dabs	Yes	Yes
E-WM-12	75	Plasmor Aglite Ultima	1050	Plasterboard (8kg/m <sup>2</sup> ) on dabs	Yes	Yes
E-WM-13	75	Aircrete - thin joint	600 to 800	Plasterboard (8kg/m <sup>2</sup> ) on dabs on cement render	Yes	Yes
E-WM-16	100	Dense	1850 to 2300	Plasterboard (9.8kg/m <sup>2</sup> ) on dabs	Yes	Yes
E-WM-18	100	Dense	1850 to 2300	Wet plaster	Yes	Yes
E-WM-19	100	Dense or light aggregate (or nominated hollow or cellular blocks)	1350 to 1600 or 1850 to 2300	Plasterboard (8kg/m <sup>2</sup> ) on dabs on cement render	Yes	Yes
E-WM-21	100	Light aggregate	1350 to 1600	Wet plaster	Yes	Yes
E-WM-22	100	Light aggregate	1350 to 1600	Plasterboard (10kg/m <sup>2</sup> ) on dabs (No parge coat)	No	Yes
E-WM-25	100	Porotherm	n/a	Plasterboard (8kg/m <sup>2</sup> ) on dabs	Yes	Yes
E-WM-26	100	Besblock	1528	Plasterboard (10kg/m <sup>2</sup> ) on dabs	No	Yes
E-WM-29	75	Porotherm	n/a	Plasterboard (8kg/m <sup>2</sup> ) on dabs	Yes	Yes
E-WM-31	100	H+H Celcon Elements	575	Plasterboard (8kg/m <sup>2</sup> ) on dabs	No	Yes
E-WM-32	75	Light aggregate	1350 to 1600	Plasterboard (10kg/m <sup>2</sup> ) on dabs	No	Yes

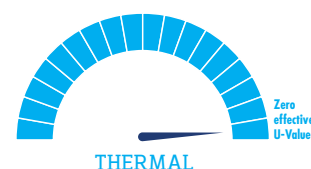
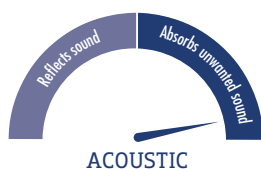

Fire: Euroclass reaction to fire classification | Sustainability: Generic BRE Green Guide rating



**NON-COMBUSTIBLE  
INSULATION**

### PRODUCT DESCRIPTION

Timber Frame Party Wall Slab is a Glass Mineral Wool slab, designed for use in timber frame party walls, that offers thermal and acoustic performance.

It is non-combustible with the best possible Euroclass A1 reaction to fire classification, and is manufactured using Knauf Insulation's unique bio-based binder, ECOSE® Technology.

### BENEFITS

- Fully filling the party wall cavity contributes towards a zero effective U-value, simplifying compliance with building regulations.
- Suitable for use with a range of constructions registered in the Robust Details Handbook reducing the need for on-site acoustic testing.
- Awarded the DECLARE 'Red List Free' label which means it is free of any harmful chemicals listed on the Living Building Challenge (LBC) Red List.



### APPLICATION

- Separating (Party) Walls - Built-In (see page 64)

For the Feel Good Factor, use Knauf Insulation Mineral Wool with the added ECOSE® Technology benefits. See page 24 for further details.



### CERTIFICATION



## SPECIFICATIONS



### TIMBER FRAME PARTY WALL SLAB

Thickness (mm)	Density (kg/m <sup>3</sup> )	Length (mm)	Width (mm)	Slabs per pack	Area per pack (m <sup>2</sup> )	Packs per pallet	Pallet product code
85	18.00	1200	600	12	8.640	16	2441340
60	18.00	1200	600	16	11.520	16	2441338

All dimensions are nominal.

### ROBUST DETAIL SEPARATING WALLS AND PARTY WALL BYPASS SOLUTIONS - TIMBER FRAME PARTY WALL SLAB

Robust Detail Wall Type	Minimum Cavity Width (mm)	Sheathing	Wall Finish	External (flanking) wall	Zero U-value
E-WT-1	50	None <sup>1</sup>	2 or more layers of gypsum-based board	Outer leaf masonry min 50mm cavity	Yes
E-WT-2	50	9mm(min) thick board	2 or more layers of gypsum-based board	Outer leaf masonry min 50mm cavity	Yes
E-WT-3	50	None	2 or more layers of gypsum-based board	Outer leaf masonry min 50mm cavity	Yes

<sup>1</sup> Partial sheathing of the cavity faces of the separating wall for structural reasons is permitted but the cavity width must be 50mm including sheathing

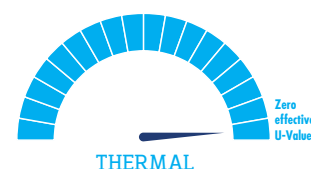
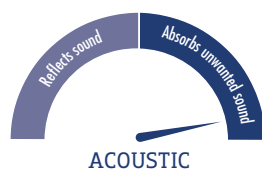

Fire: Euroclass reaction to fire classification | Sustainability: Generic BRE Green Guide rating





**NON-COMBUSTIBLE  
INSULATION**

### PRODUCT DESCRIPTION

FrameTherm® Slab 32 is a Glass Mineral Wool slab, designed for use in timber frame applications between studwork, offering a range of thermal performance to meet construction requirements.

They are non-combustible with the best possible Euroclass A1 reaction to fire classification, and are manufactured using Knauf Insulation's unique bio-based binder, ECOSE® Technology.

### BENEFITS

- Designed to friction fit between timber studs, which prevents air movement and infiltration through or around the insulation, minimising heat loss.
- Allows quick and simple installation, maximising on-site efficiency when compared with alternative insulants.
- Awarded the DECLARE 'Red List Free' label which means it is free of any harmful chemicals listed on the Living Building Challenge (LBC) Red List.

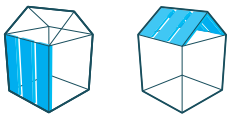

### APPLICATION

- Pitched Roofs - Rafter Level (see page 34)
- Timber Frame Walls - Built-in insulation between studs with partially filled cavity (see page 50)

For the Feel Good Factor, use Knauf Insulation Mineral Wool with the added ECOSE® Technology benefits. See page 24 for further details.



### CERTIFICATION



SPECIFICATIONS



FRAMETHERM® SLAB 32

Thickness (mm)	Thermal conductivity (W/mK)	Thermal resistance (m <sup>2</sup> K/W)	Length (mm)	Width (mm)	Slabs per pack	Area per pack (m <sup>2</sup> )	Packs per pallet	Area per pallet (m <sup>2</sup> )	Pallet product code
140	0.032	4.35	1170	570	4	2.668	16	42.72	2438531

All dimensions are nominal.



Fire: Euroclass reaction to fire classification | Sustainability: Generic BRE Green Guide rating

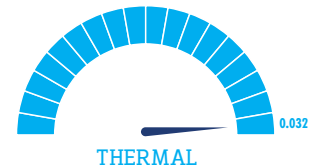
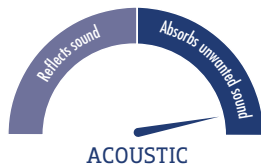



**NON-COMBUSTIBLE  
INSULATION**

### PRODUCT DESCRIPTION

OmniFit® Roll 34 is a Glass Mineral Wool roll, designed for use in multiple applications in both timber and steel frame construction, that offers the best thermal and acoustic performance in the range.

OmniFit® Roll 40 is a Glass Mineral Wool roll, designed for use in multiple applications that offers excellent thermal and acoustic performance.

They are both non-combustible with the best possible Euroclass A1 reaction to fire classification, and are manufactured using Knauf Insulation's unique bio-based binder, ECOSE® Technology.

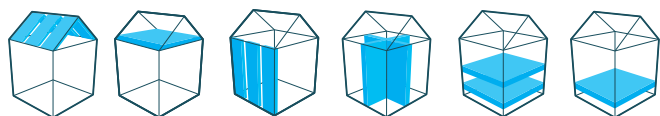

### APPLICATION

- Pitched Roofs - Ceiling Level (see page 32)
- Pitched Roofs - Rafter Level (see page 34)
- Rainscreen Façade System (see page 56)
- Frame Construction With Masonry Outer (see page 58)
- Suspended Timber Ground Floors (see page 70)
- Separating Floors - Timber (see page 74)
- Separating Floors - Upgrade to an existing timber floor with new ceiling (see page 76)
- Separating Floors - Upgrade to an existing timber floor with new platform floor (see page 77)
- Internal Floors (see page 79)

### BENEFITS

- Multi-purpose product which can be used to insulate a wide range of applications, meaning less products on a vehicle and on-site.
- Rolls are 1200mm wide to allow cutting for installation at varying centre dimensions, providing flexibility on-site.
- OmniFit® Roll 40 is partially perforated for use in either timber or steel frame applications at 400mm or 600mm centres.
- Friction fitting between rafters and studwork provides an optimum seal and prevents gaps which can otherwise lead to unwanted heat loss.
- Awarded the DECLARE 'Red List Free' label which means it is free of any harmful chemicals listed on the Living Building Challenge (LBC) Red List.

For the Feel Good Factor, use Knauf Insulation Mineral Wool with the added ECOSE® Technology benefits. See page 24 for further details.



### CERTIFICATION





SPECIFICATIONS

OMNIFIT® ROLL 34 (UNCUT)

Thickness (mm)	Thermal conductivity (W/mK)	Thermal resistance (m <sup>2</sup> K/W)	Length (m)	Width (mm)	Area per pack (m <sup>2</sup> )	Rolls per pallet	Pallet product code
220*	0.034	6.45	2.50	1200	3.000	24	416121
180	0.034	5.25	3.00	1200	3.600	24	416113
150	0.034	4.40	3.50	1200	4.200	24	417800
140	0.034	4.10	4.20	1200	5.040	24	474996
100	0.034	2.90	5.20	1200	6.240	24	417796



All dimensions are nominal. \* Full loads only

OMNIFIT® ROLL 40 (COMBI-CUT)

Thickness (mm)	Thermal conductivity (W/mK)	Thermal resistance (m <sup>2</sup> K/W)	Length (m)	Width (mm)	Area per pack (m <sup>2</sup> )	Rolls per pallet	Pallet product code
200	0.040	5.00	3.40	1200 (2x600 or 3x400)	4.080	40	474509
150	0.040	3.75	4.55	1200 (2x600 or 3x400)	5.460	40	474386
100	0.040	2.50	6.80	1200 (2x600 or 3x400)	8.160	40	474381



All dimensions are nominal

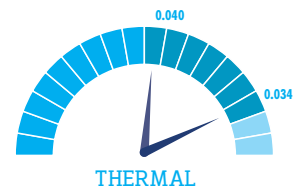
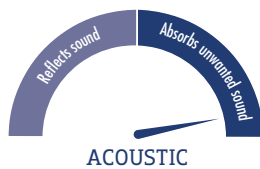

Fire: Euroclass reaction to fire classification | Sustainability: Generic BRE Green Guide rating



**NON-COMBUSTIBLE INSULATION**

### PRODUCT DESCRIPTION

OmniFit® Slab 35 is a Glass Mineral Wool slab, designed for use in multiple applications in both timber and steel frame construction, that offers excellent thermal and acoustic performance.

It is non-combustible with the best possible Euroclass A1 reaction to fire classification, and is manufactured using Knauf Insulation's unique bio-based binder, ECOSE® Technology.

### BENEFITS

- Multi-purpose product which can be used to insulate a wide range of applications, meaning less products on a vehicle and on-site.
- Manufactured size allows friction fitting between common stud centres without any cutting and waste on-site.
- Engineered to provide high level of robustness whilst maintaining installation flexibility.
- Awarded the DECLARE 'Red List Free' label which means it is free of any harmful chemicals listed on the Living Building Challenge (LBC) Red List.

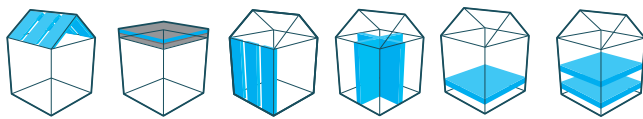

### APPLICATION

- Pitched Roofs - Rafter Level (see page 34)
- Flat Roof - Cold Roof (see page 38)
- Timber Frame Walls - Built-in insulation between studs with partially filled cavity (see page 50)
- Timber Frame Walls - Built-in insulation between studs with low emissivity service void (see page 52)
- Rainscreen Façade System (see page 56)
- Frame Construction With Masonry Outer (see page 58)
- Internal Walls (see page 68)
- Suspended Timber Ground Floors (see page 70)
- Separating Floors - Timber (see page 74)
- Separating Floors - Upgrade to an existing timber floor with new ceiling (see page 76)
- Separating Floors - Upgrade to an existing timber floor with new platform floor (see page 77)
- Internal Floors (see page 79)

For the Feel Good Factor, use Knauf Insulation Mineral Wool with the added ECOSE® Technology benefits. See page 24 for further details.



### CERTIFICATION



## SPECIFICATIONS



### OMNIFIT® SLAB 35 (600MM WIDE)

Thickness (mm)	Thermal conductivity (W/mK)	Thermal resistance (m <sup>2</sup> K/W)	Length (mm)	Width (mm)	Slabs per pack	Area per pack (m <sup>2</sup> )	Packs per pallet	Pallet product code
150	0.035	4.25	1200	600	4	2.880	32	587280
140	0.035	4.00	1200	600	4	2.880	36	474342
100	0.035	2.85	1200	600	6	4.320	32	474340
90	0.035	2.55	1200	600	6	4.320	36	474337
75	0.035	2.10	1200	600	8	5.760	32	587268
70	0.035	2.00	1200	600	8	5.760	32	474334
50	0.035	1.40	1200	600	12	8.640	24	474329

All dimensions are nominal.



### OMNIFIT® SLAB 35 (400MM WIDE)

Thickness (mm)	Thermal conductivity (W/mK)	Thermal resistance (m <sup>2</sup> K/W)	Length (mm)	Width (mm)	Slabs per pack	Area per pack (m <sup>2</sup> )	Packs per pallet	Pallet product code
140	0.035	4.00	1200	400	4	1.920	48	474318
100	0.035	2.85	1200	400	6	2.880	42	474314
50	0.035	1.40	1200	400	12	5.760	36	474293

All dimensions are nominal.

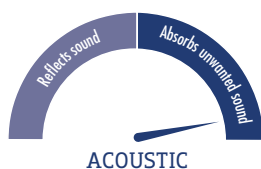

Fire: Euroclass reaction to fire classification | Sustainability: Generic BRE Green Guide rating





### APPLICATION

- External Masonry Cavity Walls Blown-In (New Build) (see page 46)
- External Masonry Cavity Walls Blown-In (Retrofit) (see page 48)



### NON-COMBUSTIBLE INSULATION

### PRODUCT DESCRIPTION

Supafil® 34 is a Glass Mineral Blowing Wool, designed for use in external masonry cavity walls, that offers the best thermal performance in the Supafil® range.

Supafil® 40 is a Glass Mineral Blowing Wool, designed for use in external masonry cavity walls, that offers excellent thermal performance.

They are non-combustible with the best possible Euroclass A1 reaction to fire classification.

### BENEFITS

- Water-repellent and BBA certified for use in all exposure zones, including those in very severe areas.
- Installed by approved installing technicians who bring product to site meaning no storage is required on site before installation, and no waste is left on-site post-installation.
- Awarded the DECLARE 'Red List Free' label which means it is free of any harmful chemicals listed on the Living Building Challenge (LBC) Red List.



### CERTIFICATION



SPECIFICATIONS



SUPAFIL® 34

Pack Weight (kg)	Thermal Conductivity (W/mK)	Pack Dimensions (mm)	Packs per pallet	Pallet product code
15.5	0.034	1200x550x250	28	2441358

All dimensions are nominal.  
Available via approved contractors.



SUPAFIL® 40

Pack Weight (kg)	Thermal Conductivity (W/mK)	Pack Dimensions (mm)	Packs per pallet	Pallet product code
17.6	0.040	1200x550x250	28	2409790

All dimensions are nominal.  
Available via approved contractors.



Fire: Euroclass reaction to fire classification | Sustainability: Generic BRE Green Guide rating

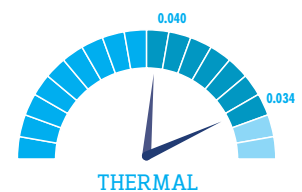
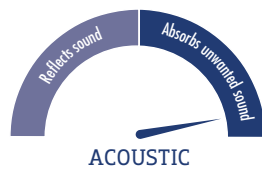



### NON-COMBUSTIBLE INSULATION

#### PRODUCT DESCRIPTION

Supafil® CarbonPlus is a Glass Mineral Blowing Wool, designed for use in narrow (down to 40mm) external masonry cavity walls.

It is non-combustible with the best possible Euroclass A1 reaction to fire classification.

#### BENEFITS

- Water repellent and BBA certified for use in all exposure zones, including those in very severe areas.
- Installed by approved installing technicians who bring product to site meaning no storage is required on site before installation, and no waste is left on-site post-installation.
- Awarded the DECLARE 'Red List Free' label which means it is free of any harmful chemicals listed on the Living Building Challenge (LBC) Red List.



#### APPLICATION

- External Masonry Cavity Walls Blown-In (Retrofit) (see page 48)



#### CERTIFICATION





SPECIFICATIONS



SUPAFIL® CARBONPLUS

Pack Weight (kg)	Thermal Conductivity (W/mK)	Pack Dimensions (mm)	Packs per pallet	Pallet product code
15.5	0.034	1200x550x250	28	409307

All dimensions are nominal.  
Available via approved contractors.

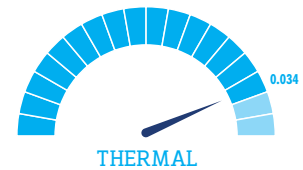
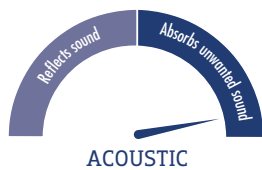

Fire: Euroclass reaction to fire classification | Sustainability: Generic BRE Green Guide rating

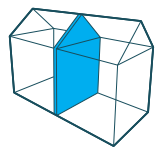

### APPLICATION

- Separating (Party) Walls - Blown-In (see page 64)



## NON-COMBUSTIBLE INSULATION

### PRODUCT DESCRIPTION

Supafil® Party Wall is a Glass Mineral Blowing Wool, designed for use in masonry separating party walls, that prevents thermal bypass and offers excellent acoustic performance.

It is non-combustible with the best possible Euroclass A1 reaction to fire classification.

### BENEFITS

- Suitable for use with a range of constructions registered in the Robust Details Handbook reducing the need for onsite acoustic testing.
- Fully filling the party wall cavity contributes towards a zero effective U-value, simplifying compliance with building regulations.
- Installed by approved installing technicians who bring product to site meaning no storage is required on site before installation, and no waste is left on-site post-installation.
- Its blue colour provides visual identification and assurance that the right product is being used for the right application.
- Awarded the DECLARE 'Red List Free' label which means it is free of any harmful chemicals listed on the Living Building Challenge (LBC) Red List.



### CERTIFICATION



SPECIFICATIONS



SUPAFIL® PARTY WALL

Pack Weight (kg)	Installed Density (kg/m <sup>3</sup> )	Pack Dimensions (mm)	Packs per pallet	Pallet product code
17.6	18.00	1200x550x250	28	2441359

All dimensions are nominal.  
Available via approved contractors.

Robust Detail Separating Walls and Party Wall Bypass Solutions - Supafil® Party Wall

Robust Detail Wall Type	Minimum Cavity Width (mm)	Block Type	Block Density (kg/m <sup>3</sup> )	Wall Finish	Parge coat	Zero U-value
E-WM-1	75	Dense	1850 to 2300	Wet plaster	Yes	Yes
E-WM-2	75	Light aggregate	1350 to 1600	Wet plaster	Yes	Yes
E-WM-3	75	Dense	1850 to 2300	Plasterboard (8kg/m <sup>2</sup> ) on dabs	Yes	Yes
E-WM-4	75	Light aggregate	1350 to 1600	Plasterboard (8kg/m <sup>2</sup> ) on dabs	Yes	Yes
E-WM-5	75	Besblock 'Star Performer'	1528	Plasterboard (8kg/m <sup>2</sup> ) on dabs on cement render	Yes	Yes
E-WM-6	75	Aircrete	600 to 800	Plasterboard (8kg/m <sup>2</sup> ) on dabs on cement render	Yes	Yes
E-WM-10	75	Aircrete - thin joint	600 to 800	Plasterboard (8kg/m <sup>2</sup> ) on dabs on cement render	Yes	Yes
E-WM-11	100	Light aggregate (or nominated hollow or cellular blocks)	1350 to 1600	Plasterboard (8kg/m <sup>2</sup> ) on dabs	Yes	Yes
E-WM-12	75	Plasmor Aglite Ultima	1050	Plasterboard (8kg/m <sup>2</sup> ) on dabs	Yes	Yes
E-WM-13	75	Aircrete - thin joint	600 to 800	Plasterboard (8kg/m <sup>2</sup> ) on dabs on cement render	Yes	Yes
E-WM-16	100	Dense	1850 to 2300	Plasterboard (9.6kg/m <sup>2</sup> ) on dabs	Yes	Yes
E-WM-18	100	Dense	1850 to 2300	Wet plaster	Yes	Yes
E-WM-19	100	Dense or light aggregate (or nominated hollow or cellular blocks)	1350 to 1600 or 1850 to 2300	Plasterboard on dabs on cement render	Yes	Yes
E-WM-21	100	Light aggregate	1350 to 1600	Wet plaster	Yes	Yes
E-WM-26	100	Besblock 'Star Performer'	1528	Plasterboard (10kg/m <sup>2</sup> ) on dabs	No	Yes
E-WM-28	100	Light aggregate	1350 to 1600	Plasterboard (8kg/m <sup>2</sup> ) on dabs	No	Yes
E-WM-30	100	Aircrete - standard and thin joint	600 to 800	Plasterboard (8kg/m <sup>2</sup> ) on dabs	No	Yes
E-WM-31	100	H+H - Celcon Elements - thin joint	575	Plasterboard (8kg/m <sup>2</sup> ) on dabs	No	Yes



FIRE

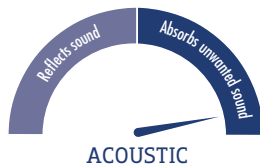

ACOUSTIC



SUSTAINABILITY

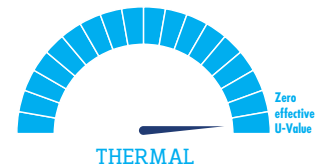

THERMAL

Fire: Euroclass reaction to fire classification | Sustainability: Generic BRE Green Guide rating



**NON-COMBUSTIBLE  
INSULATION**

### PRODUCT DESCRIPTION

Supafil® Frame is a Glass Mineral Blowing Wool, designed for use in either on-site or off-site timber frame construction, that offers excellent thermal performance.

It is non-combustible with the best possible Euroclass A1 reaction to fire classification.

### BENEFITS

- Multi-purpose product which can insulate a variety of timber frame applications, maximising efficiency.
- Provides intimate contact between frames, offering a full-fill solution for a wide range of stud depths, centres and void shapes.
- Can be installed either on-site or off-site, using our innovative Supafil® Frame System.
- Only one product needed which can insulate all timber frame applications.
- Awarded the DECLARE 'Red List Free' label which means it is free of any harmful chemicals listed on the Living Building Challenge (LBC) Red List.

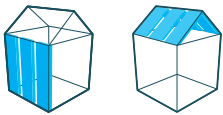

### APPLICATION

- Timber Frame Walls - Blown-In (see page 54)

### CERTIFICATION





SPECIFICATIONS



SUPAFIL® FRAME

Pack Weight (kg)	Thermal Conductivity (W/mK)	Pack Dimensions (mm)	Packs per pallet	Pallet product code
15.5	0.033 – 0.038 <sup>(i)</sup>	1200x550x250	28	2436637

All dimensions are nominal.

Available via approved contractors.

(i) Thermal conductivity varies with installed density and application as follows:

Angle range (°)	Thermal conductivity (W/mK)	Installed density (kg/m <sup>3</sup> )
0–25	0.038	19.0
0–90	0.034	26.0
0–90	0.033	30.0



Our Supafil® Frame System offers an innovative installation solution which combines our Supafil® Frame Blown Glass Mineral Wool , machine and panel to achieve consistent quality and fast installation times.

Understanding that every system is tailor-made, we can work with you to recommend the best insulation solution for your system.

Visit [knaufinsulation.co.uk/offsite-solutions](http://knaufinsulation.co.uk/offsite-solutions) for further information

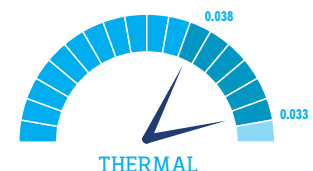
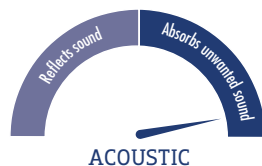

Fire: Euroclass reaction to fire classification | Sustainability: Generic BRE Green Guide rating



**NON-COMBUSTIBLE INSULATION**

### PRODUCT DESCRIPTION

Rocksilk® RainScreen Slab is a BBA certified Rock Mineral Wool slab designed for use as rainscreen insulation in Façade Systems for buildings of any height.

It is non-combustible with the best possible Euroclass A1 reaction to fire classification, and is manufactured using Knauf Insulation's unique bio-based binder, ECOSE® Technology.

### BENEFITS

- BBA Certified (certificate 19/5609) for the widest range of thicknesses and build-ups of any rainscreen solution on the market so it can be specified with confidence.
- Free 3D U-value calculation service.
- Made with a water-repellent additive - slabs will maintain their integrity while exposed on site.
- Slabs are engineered to adapt to minor imperfections in the substrates.
- Suitable for use on all buildings including those above 18m in height.
- Black Glass Veil makes the product suitable for semi visible areas such as behind perforated panels.



### APPLICATION

- Timber Frame Walls - Built-in insulation between studs with partially filled cavity (see page 50)
- Rainscreen Façade System (see page 56)
- Frame Construction With Masonry Outer (see page 58)



\*not BGV

For the Feel Good Factor, use Knauf Insulation Mineral Wool with the added ECOSE® Technology benefits. See page 24 for further details.



### CERTIFICATION



## SPECIFICATIONS



## ROCKSILK® RAINSCREEN SLAB

Thickness (mm)	Thermal conductivity (W/mK)	Thermal resistance (m <sup>2</sup> K/W)	Length (mm)	Width (mm)	Pieces per pack	Packs per pallet	Area per pack (m <sup>2</sup> )	Area per pallet (m <sup>2</sup> )	Pallet product code
250	0.034	7.35	1200	600	2	10	1.440	14.400	656411
240	0.034	7.05	1200	600	2	10	1.440	14.400	656410
230	0.034	6.75	1200	600	2	12	1.440	17.280	656409
220	0.034	6.45	1200	600	2	12	1.440	17.280	656408
210	0.034	6.15	1200	600	2	12	1.440	17.280	640933
200	0.034	5.85	1200	600	2	12	1.440	17.280	640930
190	0.034	5.55	1200	600	2	12	1.440	17.280	652477
180	0.034	5.25	1200	600	3	10	2.160	21.600	640927
170	0.034	5.00	1200	600	3	10	2.160	21.600	651506
165	0.034	4.85	1200	600	3	10	2.160	21.600	658742
160	0.034	4.70	1200	600	3	10	2.160	21.600	651512
155	0.034	4.55	1200	600	3	12	2.160	25.920	658741
150	0.034	4.40	1200	600	3	12	2.160	25.920	640921
140	0.034	4.10	1200	600	3	12	2.160	25.920	651513
130	0.034	3.80	1200	600	3	12	2.160	25.920	651499
125	0.034	3.65	1200	600	4	10	2.880	28.800	658740
120	0.034	3.50	1200	600	4	10	2.880	28.800	640916
110	0.034	3.20	1200	600	4	12	2.880	34.560	650811
100	0.034	2.90	1200	600	4	12	2.880	34.560	640914
90	0.034	2.60	1200	600	5	12	3.600	43.200	650810
80	0.034	2.35	1200	600	5	12	3.600	43.200	650809
75	0.034	2.2	1200	600	6	12	4.320	51.840	640911
70	0.034	2.05	1200	600	6	12	4.320	51.840	650808
60	0.034	1.75	1200	600	7	12	5.040	60.480	650807
50	0.034	1.45	1200	600	8	12	5.760	69.120	640909
150 BGV*	0.034	4.40	1200	600	3	12	2.160	25.920	640959
120 BGV*	0.034	3.50	1200	600	4	10	2.880	28.800	640949
100 BGV*	0.034	2.90	1200	600	4	12	2.880	34.560	640935

  Standard thickness. All dimensions are nominal. \* Black Glass Veil facing.



Fire: Euroclass reaction to fire classification | Sustainability: Generic BRE Green Guide rating

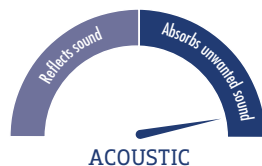

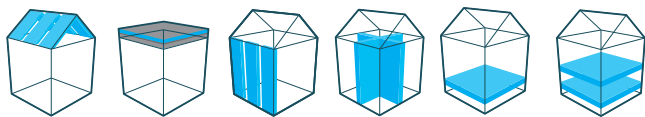

### APPLICATION

- Pitched Roofs - Rafter Level (see page 34)
- Flat Roof - Cold Roof (see page 38)
- Timber Frame Walls - Built-in insulation between studs with partially filled cavity (see page 50)
- Timber Frame Walls - Built-in insulation between studs with low emissivity service void (see page 52)
- Rainscreen Façade System (see page 56)
- Frame Construction With Masonry Outer (see page 58)
- Internal Walls (see page 68)
- Suspended Timber Ground Floors (see page 70)
- Separating Floors - Upgrade to an existing timber floor with new ceiling (see page 76)
- Separating Floors - Upgrade to an existing timber floor with new platform floor (see page 77)
- Internal Floors (see page 79)



NON-COMBUSTIBLE  
INSULATION

### PRODUCT DESCRIPTION

Rocksilk® Building Slabs are Rock Mineral Wool slabs manufactured in a range of densities, designed for use in multiple thermal and acoustic applications where density is critical.

They are non-combustible with the best possible Euroclass A1 reaction to fire classification, and are manufactured using Knauf Insulation's unique bio-based binder, ECOSE® Technology.

### BENEFITS

- Single slab can be used for multiple applications.
- Can be provided with a factory applied foil or tissue facing, offering solutions for a wide variety of applications.

For the Feel Good Factor, use Knauf Insulation Mineral Wool with the added ECOSE® Technology benefits. See page 24 for further details.



### CERTIFICATION





## SPECIFICATIONS

Thickness (mm)	Thermal conductivity (W/mK)	Thermal resistance (m <sup>2</sup> K/W)	Length (mm)	Width (mm)	Pieces per pack	Area per pack (m <sup>2</sup> )	Packs per pallet	Pallet product code
<b>ROCKSILK® RS45</b>								
150	0.035	4.25	1200	600	3	2.160	12	531096
100	0.035	2.85	1200	600	5	3.600	12	2411339
75	0.035	2.10	1200	600	6	4.320	12	2411328
60	0.035	1.70	1200	600	8	5.760	12	2411425
50	0.035	1.40	1200	600	10	7.200	12	2411327
40	0.035	1.10	1200	600	12	8.640	12	2411326
30	0.035	0.85	1200	600	16	11.520	12	2411424
25	0.035	0.70	1200	600	20	14.400	12	2411325
<b>ROCKSILK® RS60</b>								
100	0.034	2.90	1200	600	4	2.880	12	2411331
75	0.034	2.20	1200	600	6	4.320	12	2411330
60	0.034	1.75	1200	600	7	5.040	12	2411433
50	0.034	1.45	1200	600	9	6.480	12	2411329
40	0.034	1.15	1200	600	12	8.640	12	2411432
25	0.034	0.70	1200	600	18	12.960	12	2411430
<b>ROCKSILK® RS80</b>								
100	0.034	2.90	1200	600	3	2.160	16	2411332
75	0.034	2.20	1200	600	4	2.880	16	2411437
50	0.034	1.45	1200	600	6	4.320	16	2411435
<b>ROCKSILK® RS100</b>								
100	0.034	2.90	1200	600	3	2.160	16	2411334
75	0.034	2.20	1200	600	4	2.880	16	2411333
50	0.034	1.45	1200	600	6	4.320	16	2411441
40	0.034	1.15	1200	600	7	5.040	16	2411440
30	0.034	0.85	1200	600	10	7.200	16	2411439
25	0.034	0.70	1200	600	12	8.640	16	2411438
<b>ROCKSILK® RS100 WHITE TISSUE FACING 1</b>								
30	0.034	0.85	1200	600	10	7.200	16	528143
<b>ROCKSILK® RS140</b>								
100	0.034	2.90	1200	600	2	1.440	12	2432553
75	0.034	2.20	1200	600	3	2.160	10	2411447
50	0.034	1.45	1200	600	4	2.880	12	2411446
40	0.034	1.15	1200	600	5	3.600	12	2411445
30	0.034	0.85	1200	600	7	5.040	10	2411444

All dimensions are nominal.

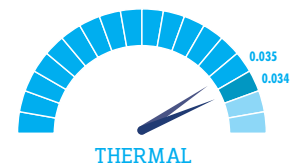
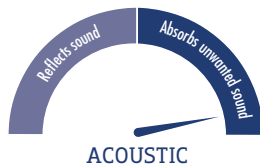

Fire: Euroclass reaction to fire classification | Sustainability: Generic BRE Green Guide rating



**NON-COMBUSTIBLE INSULATION**

### PRODUCT DESCRIPTION

Rocksilk® Flexible Slab is a Rock Mineral Wool slab, designed for use in multiple thermal and acoustic applications as well as the fire protection of a loft conversion floor.

It is non-combustible with the best possible Euroclass A1 reaction to fire classification, and is manufactured using Knauf Insulation's unique bio-based binder, ECOSE® Technology.

### BENEFITS

- Multi-purpose product which can be used to insulate a wide range of applications on site.
- Flexible on all four sides for quick and simple installation.
- Provides a solution to allow existing ceilings to be retained in loft conversion projects to meet the requirements of building regulations.

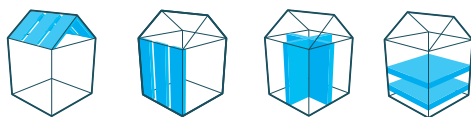

### APPLICATION

- Pitched Roofs - Rafter Level (see page 34)
- Timber Frame Walls - Built-in insulation between studs with partially filled cavity (see page 50)
- Timber Frame Walls - Built-in insulation between studs with low emissivity service void (see page 52)
- Rainscreen Façade System (see page 56)
- Frame Construction With Masonry Outer (see page 58)
- Internal Walls (see page 68)
- Suspended Timber Ground Floors (see page 70)
- Separating Floors - Timber (see page 74)
- Separating Floors - Upgrade to an existing timber floor with new ceiling (see page 76)
- Separating Floors - Upgrade to an existing timber floor with new platform floor (see page 77)
- Internal Floors (see page 79)

For the Feel Good Factor, use Knauf Insulation Mineral Wool with the added ECOSE® Technology benefits. See page 24 for further details.



### CERTIFICATION



## SPECIFICATIONS



### ROCKSILK® FLEXIBLE SLAB

Thickness (mm)	Thermal conductivity (W/mK)	Thermal resistance (m <sup>2</sup> K/W)	Length (mm)	Width (mm)	Pieces per pack	Area per pack (m <sup>2</sup> )	Packs per pallet	Pallet product code
140	0.035	4.00	1200	600	3	2.160	12	2411335
100	0.037	2.70	1200	600	6	4.320	12	457994
90	0.037	2.40	1200	600	6	4.320	12	457997
70	0.037	1.85	1200	600	8	5.760	12	2411408
60	0.037	1.60	1200	600	10	7.200	12	457996
50	0.037	1.35	1200	600	12	8.640	12	457995
40	0.037	1.05	1200	600	14	10.080	12	531594

All dimensions are nominal.



Fire: Euroclass reaction to fire classification | Sustainability: Generic BRE Green Guide rating

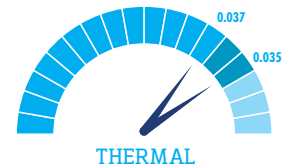
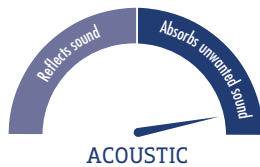



**NON-COMBUSTIBLE INSULATION**

### PRODUCT DESCRIPTION

Rocksilk® Acoustic Floor Slab is a Rock Mineral Wool slab, designed to meet the acoustic requirements for use in floating floors.

Rocksilk® Acoustic Floor Slab Plus is a Rock Mineral Wool slab with the highest load bearing capability in the range.

They are non-combustible with the best possible Euroclass A1 reaction to fire classification, and are manufactured using Knauf Insulation's unique bio-based binder, ECOSE® Technology.



### APPLICATION

- Separating Floors - Concrete (see page 78)

### BENEFITS

- Suitable for use with a range of constructions registered in the Robust Details Handbook eliminating the need for on-site acoustic testing.
- Significantly reduces the amount of sound transferred between floors.
- Slabs are engineered to adapt to minor imperfections in the substrates.

For the Feel Good Factor, use Knauf Insulation Mineral Wool with the added ECOSE® Technology benefits. See page 24 for further details.



### CERTIFICATION





SPECIFICATIONS



ROCKSILK® ACOUSTIC FLOOR SLAB

Thickness (mm)	Thermal conductivity (W/mK)	Length (mm)	Width (mm)	Pieces per pack	Area per pack (m <sup>2</sup> )	Packs per pallet	Pallet product code
25	0.036	1000	600	12	7.200	16	606070

ROCKSILK® ACOUSTIC FLOOR SLAB PLUS

Thickness (mm)	Thermal conductivity (W/mK)	Length (mm)	Width (mm)	Pieces per pack	Area per pack (m <sup>2</sup> )	Packs per pallet	Pallet product code
50	0.036	1000	600	4	2.400	24	606068
25	0.036	1000	600	8	4.800	24	606069

All dimensions are nominal.



Fire: Euroclass reaction to fire classification | Sustainability: Generic BRE Green Guide rating

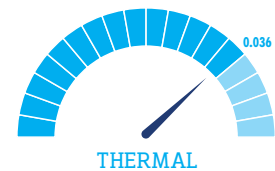
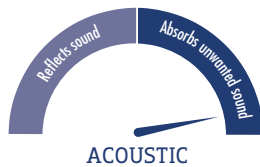



**NON-COMBUSTIBLE  
INSULATION**

Rocksilk® Soffit Linerboard Standard

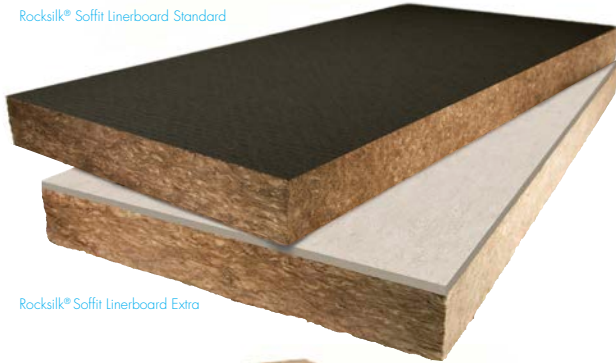

Rocksilk® Soffit Linerboard Extra

Rocksilk® Soffit Linerboard Unfaced

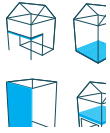

### APPLICATION

- Exposed Soffit Floors (see page 72)

### PRODUCT DESCRIPTION

Rocksilk® Soffit Linerboard Standard and Extra are Rock Mineral Wool slabs, designed to insulate structural soffits in applications such as underground car parks.

They are non-combustible with the best possible Euroclass A1 reaction to fire classification, and are manufactured using Knauf Insulation's unique bio-based binder, ECOSE® Technology.

Rocksilk® Soffit Linerboard Extra has a non-combustible facing board, with a black facing so it can be used in semi-exposed environments such as open-sided car parks.

### BENEFITS

- Impact resistant fibre cement flat sheet ideal for semi exposed environments.
- Provides a solution to upgrade thermal performance of existing floors without reducing floor height.
- Can be installed without the need to access areas above the floor.

For the Feel Good Factor, use Knauf Insulation Mineral Wool with the added ECOSE® Technology benefits. See page 24 for further details.



### CERTIFICATION



## SPECIFICATIONS

## ROCKSILK® SOFFIT LINERBOARD STANDARD

Thickness (mm)	Thermal conductivity (W/mK)	Thermal resistance (m <sup>2</sup> K/W)	Length (mm)	Width (mm)	Slabs per pallet	Area per pallet (m <sup>2</sup> )	Pallet product code
220	0.034	6.45	1200	600	20	14.400	469973
185	0.034	5.40	1200	600	28	20.160	672812
160	0.034	4.70	1200	600	28	20.160	2411455
130	0.034	3.70	1200	600	36	25.920	2411454

## ROCKSILK® SOFFIT LINERBOARD EXTRA

Thickness (mm)	Thermal conductivity (W/mK)	Thermal resistance (m <sup>2</sup> K/W)	Length (mm)	Width (mm)	Slabs per pallet	Area per pallet (m <sup>2</sup> )	Pallet product code
220/6*	0.034 / 0.24	6.55	1200	600	10	7.200	682465
185/6*	0.034 / 0.24	5.55	1200	600	12	8.640	682466
160/6*	0.034 / 0.24	4.75	1200	600	14	10.080	2411647
130/6*	0.034 / 0.24	3.75	1200	600	18	12.960	2411648

All dimensions are nominal. \*Thickness of facing board.

## Bespoke Sizes

Rocksilk® Soffit Linerboard is available in bespoke dimensions to suit specific thermal and aesthetic requirements in thicknesses from 50 to 270mm.



Fire: Euroclass reaction to fire classification | Sustainability: Generic BRE Green Guide rating

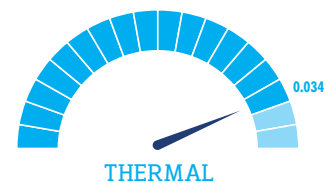
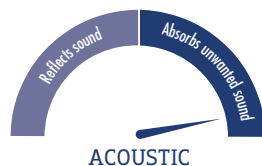



**NON-COMBUSTIBLE  
INSULATION**

### PRODUCT DESCRIPTION

Rocksilk® Fabrication Slab is a Rock Mineral Wool slab, designed for use in a wide range of fabrication applications.

It is non-combustible with the best possible Euroclass A1 reaction to fire classification, and is manufactured using Knauf Insulation's unique bio-based binder, ECOSE® Technology.

### BENEFITS

- Robust product allowing cutting to accurate tolerances for a range of applications.
- Can be provided with a factory applied foil or tissue facing, offering solutions for a wide variety of fabrication applications.



### APPLICATION

- Fabrication

For the Feel Good Factor, use Knauf Insulation Mineral Wool with the added ECOSE® Technology benefits. See page 24 for further details.



### CERTIFICATION





## SPECIFICATIONS



### ROCKSILK® FABRICATION SLAB

Thickness (mm)	Thermal conductivity (W/mK)	Thermal resistance (m <sup>2</sup> K/W)	Length (mm)	Width (mm)	Pieces per pack	Area per pack (m <sup>2</sup> )	Packs per pallet	Pallet product code
160	0.037	4.30	1200	600	3	2.160	12	512152
150	0.037	4.05	1200	600	3	2.160	12	512154
140	0.037	3.75	1200	600	3	2.160	12	512160
130	0.037	3.50	1200	600	4	2.880	12	512164
120	0.037	3.20	1200	600	4	2.880	12	512165
110	0.037	2.95	1200	600	4	2.880	12	512167
100	0.037	2.70	1200	600	5	3.600	12	512168
85	0.037	2.30	1200	600	6	4.320	12	512169
75	0.037	2.00	1200	600	6	4.320	12	512170
65	0.037	1.75	1200	600	8	5.760	12	512171

All dimensions are nominal.



Fire: Euroclass reaction to fire classification | Sustainability: Generic BRE Green Guide rating

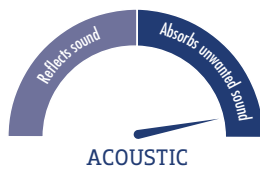



**NON-COMBUSTIBLE  
INSULATION**



### PRODUCT DESCRIPTION

Rocksilk® Flat Roof Slab is a BBA certified Rock Mineral Wool slab, designed for use in mechanically fixed flat roof build ups onto all types of roof deck.

Rocksilk® Flat Roof Slab Extra is a Rock Mineral Wool slab with the strongest mechanical performance in the range.

They are non-combustible with the best possible Euroclass A1 reaction to fire classification, and are manufactured using Knauf Insulation's Krimpack® Technology.

### BENEFITS

- Slabs contain a special additive to ensure their water repellency.
- Manufactured using Knauf Insulation's Krimpack® Technology for high levels of compressive strength and durability.
- Excellent sound absorption and reduction characteristics reducing the drumming effect of rainfall.
- Compatible with a wide range of single ply membranes.
- Slabs are engineered to adapt to minor imperfections in the substrates.

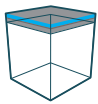

### APPLICATION

- Flat Roof - Warm Roof (see page 36)



\*not Extra

### CERTIFICATION



## SPECIFICATIONS

## ROCKSILK® FLAT ROOF SLAB

Thickness (mm)	Thermal conductivity (W/mK)	Thermal resistance (m <sup>2</sup> K/W)	Length (mm)	Width (mm)	Slabs per pallet	Pallet product code
180	0.039	4.60	1200	1000	14	606059
145	0.039	3.70	1200	1000	16	606057
120	0.039	3.05	1200	1000	20	606055
100	0.039	2.55	1200	1000	24	606052

## ROCKSILK® FLAT ROOF SLAB EXTRA

Thickness (mm)	Thermal conductivity (W/mK)	Thermal resistance (m <sup>2</sup> K/W)	Length (mm)	Width (mm)	Slabs per pallet	Pallet product code
150	0.040	3.75	1200	1000	16	606067
125	0.040	3.10	1200	1000	20	606065
105	0.040	2.60	1200	1000	24	606064
95	0.040	2.35	1200	1000	24	606061

All dimensions are nominal



Fire: Euroclass reaction to fire classification | Sustainability: Generic BRE Green Guide rating

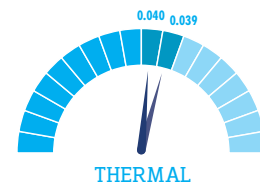
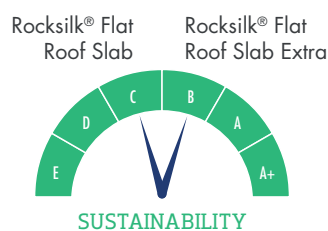
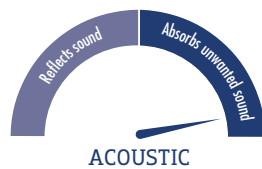



### NON-COMBUSTIBLE INSULATION



#### PRODUCT DESCRIPTION

Rocksilk® EWI Slab is a high performance non-combustible Rock Mineral Wool slab manufactured with a water-repellent additive, and is designed for use in External Wall Insulation (EWI) systems.

It is non-combustible with the best possible Euroclass A1 reaction to fire classification.

#### BENEFITS

- EWI systems made with non-combustible materials remove the need for separate fire breaks.
- Provides additional acoustic performance to the external wall.
- Breathable, allowing moisture vapour to pass through the construction removing the risk of condensation.
- Suitable for use with both silicone and mineral render systems providing design and installation flexibility.
- Easy to cut with a large bladed knife or serrated saw.



#### APPLICATION

- External Wall Insulation (see page 60)

#### CERTIFICATION





## SPECIFICATIONS

## ROCKSILK® EWI SLAB

Thickness (mm)	Thermal conductivity (W/mK)	Thermal resistance (m <sup>2</sup> K/W)	Length (mm)	Width (mm)	Pieces per pallet	Area per pallet (m <sup>2</sup> )	Pallet product code
120	0.036	3.30	1200	600	20	14.400	271217
110	0.036	3.05	1200	600	20	14.400	271267
100	0.036	2.75	1200	600	24	17.280	264383
90	0.036	2.50	1200	600	24	17.280	264382

All dimensions are nominal.

Available via approved contractors.



Fire: Euroclass reaction to fire classification | Sustainability: Generic BRE Green Guide rating

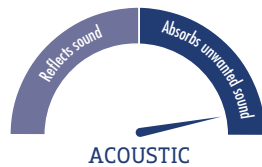



### NON-COMBUSTIBLE INSULATION



#### PRODUCT DESCRIPTION

Fire-teK Beam and Column Slab is a Rock Mineral Wool slab, for use in the fire protection of structural steel beams, column and trusses.

It is non-combustible with the best possible Euroclass A1 reaction to fire classification.

#### BENEFITS

- Non-combustible with a melting point in excess of 1000°C providing excellent levels of fire protection.
- Unlike painted solutions, Fire-teK Beam and Column Slabs are manufactured to factory tolerances, enabling the specifier to be certain that the correct thickness of fire protection has been applied.
- Quick and easy to check (by visual inspection) that all relevant areas have been protected providing an extra level of reassurance.
- Can be installed in all temperature and humidity conditions – in contrast to paints and sprays which are often restricted by normal UK winter conditions, causing potential delay to site programs.
- At less than half the weight of calcium silicate slabs – Rock Mineral Wool fire protection slabs are easy to handle and fit on site particularly for overhead work.

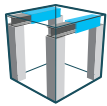

#### APPLICATION

- Fire Protection - Structural Steel (see page 82)

#### CERTIFICATION



## SPECIFICATIONS

## FIRE-TEK BEAM AND COLUMN SLAB - UNFACED

Thickness (mm)	Length (mm)	Width (mm)	Pieces per pallet	Area per pallet (m <sup>2</sup> )	Pallet product code
65	2000	1200	18	43.200	675215
60	2000	1200	20	48.000	TBC
50	2000	1200	24	57.600	TBC
45	2000	1200	27	64.800	673932
40	2000	1200	31	74.400	TBC
35	2000	1200	35	84.000	673943
30	2000	1200	40	96.000	741206
25	2000	1200	50	120.000	741179
20	2000	1200	60	144.000	675214

## FIRE-TEK BEAM AND COLUMN SLAB - FOIL FACED

Thickness (mm)	Length (mm)	Width (mm)	Pieces per pallet	Area per pallet (m <sup>2</sup> )	Pallet product code
65	2000	1200	18	43.200	723692
60	2000	1200	20	48.000	TBC
50	2000	1200	24	57.600	TBC
45	2000	1200	27	64.800	723720
40	2000	1200	31	74.400	TBC
35	2000	1200	35	84.000	723722
30	2000	1200	40	96.000	741198
25	2000	1200	50	120.000	741207
20	2000	1200	60	144.000	723721

All dimensions are nominal. Other sizes may be available subject to enquiry.

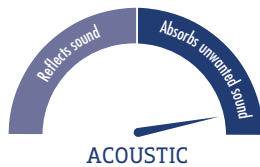

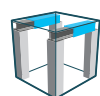

### APPLICATION

- Fire Protection - Ducts (see page 80)

### PRODUCT DESCRIPTION

Fire-tek BD 917 is a rigid Rock Mineral Wool slab reinforced with an aluminium foil facing to one side, for use in the fire protection of HVAC steel ductwork for up to 120 minutes.

### BENEFITS

- Has a melting point in excess of 1000°C providing excellent levels of fire protection.
- Applied in a single thickness, removing the need for multi-layer applications, and provides assurance of a uniform thickness and allows for easy verification of correct installation on site.
- Slab is faced with a reinforced aluminium foil, making it suitable for applications above clean rooms, within air plenums or for aesthetic purposes.
- Fast and simple fixing system of welded pins and square edge butt joints, requiring no special cuts, drilling or sub-frames so the slabs are fast and easy to install.

### CERTIFICATION





## SPECIFICATIONS

## FIRE-TEK BD 917

Thickness (mm)	Length (mm)	Width (mm)	Pieces per pack	Area per pack (m <sup>2</sup> )	Packs per pallet	Pallet product code
90	1200	600	2	1.440	12	2361482
45	1200	600	4	2.880	12	2361481

*All dimensions are nominal.*

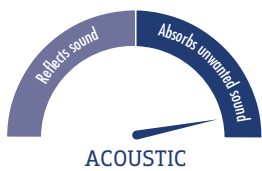

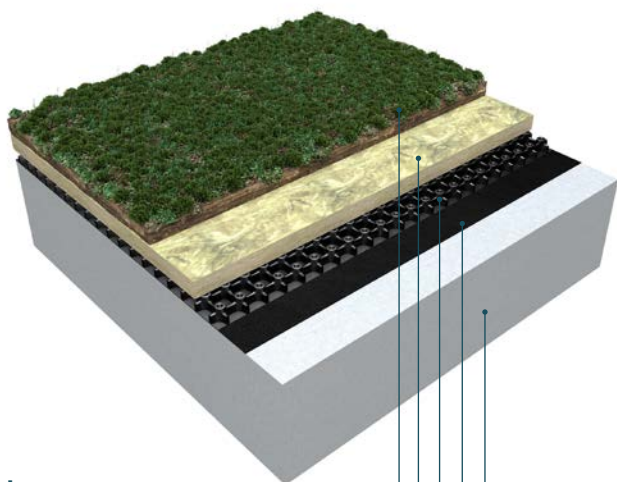

### Urbanscape® Green Roof System is made up of:

- Urbanscape® Sedum-Mix Blanket
- Urbanscape® Green Roll Substrate
- Urbanscape® Drainage with Buffer
- Urbanscape® Root Membrane
- Roof Substrate



**urbanscape**

*Above and beyond*

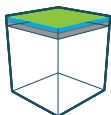

### APPLICATION

- Green Roofs (see page 42)

### PRODUCT DESCRIPTION

The Urbanscape® Green Roof System is an innovative, lightweight system using our high performance, specially designed non-combustible Rock Mineral Wool needle-felt insulation as a growing medium, as a replacement for traditional substrates. The system offers high water retention capacity, and is designed specifically for green roofs on residential, non-residential and industrial buildings in urban areas.

### BENEFITS

- Urbanscape® Green Roll is non-combustible.
- Manufactured using innovative 'needle felt' technology, providing excellent water absorption to allow even provision of water to roots for improved growing conditions.
- Urbanscape® Green Roll can hold up to 3-4 times more water for its volume than other green roof substrates, allowing lower capacity drainage systems to be used.
- Urbanscape® Green Roll is 8-10 times lighter than regular green roof substrates, meaning the Urbanscape® system can be installed onto lightweight constructions where traditional systems are otherwise not possible.
- The lightweight nature of Urbanscape® Green Roll ensures significantly lower labour during installation.
- Our innovative Performance Evaluation Tool (PET) quantifies the water retention performance of the Urbanscape® Green Roof System based on geographic location, helping designers and urban planners to understand the real performance of the roof.

### CERTIFICATION



## SPECIFICATIONS

## URBANSCAPE® SEDUM-MIX BLANKET

Thickness (mm)	Length (mm)	Width (mm)	Area per roll (m <sup>2</sup> )	Rolls per pallet	Area per pallet (m <sup>2</sup> )	Pallet product code
20	1200	1000	1.200	33	39.600	463083

## URBANSCAPE® GREEN ROLL SUBSTRATE

Thickness (mm)	Length (mm)	Width (mm)	Area per roll (m <sup>2</sup> )	Rolls per pallet	Area per pallet (m <sup>2</sup> )	Pallet product code
40	3000	1000	3.000	24	72.000	420646
20	6000	1000	6.000	24	144.000	420647

## URBANSCAPE® DRAINMAT ROLL

Thickness (mm)	Length (mm)	Width (mm)	Area per roll (m <sup>2</sup> )	Rolls per pallet	Area per pallet (m <sup>2</sup> )	Pallet product code
20	3500	1000	35.000	Supplied in individual rolls		491719

## URBANSCAPE® DRAINAGE WITH BUFFER

Thickness (mm)	Length (mm)	Width (mm)	Area per roll (m <sup>2</sup> )	Rolls per pallet	Area per pallet (m <sup>2</sup> )	Pallet product code
25	2020	1100	2.220	250	555.500	428616

## URBANSCAPE® ROOT MEMBRANE

Thickness (mm)	Length (mm)	Width (mm)	Area per roll (m <sup>2</sup> )	Rolls per pallet	Area per pallet (m <sup>2</sup> )	Pallet product code
0.5 (+/- 10%)	25	4	100.000	25	2500.000	428740

## URBANSCAPE® ALUMINIUM PROFILE

Thickness (mm)	Length (mm)	Width (mm)	Height (mm)	Units per pallet	Area per pallet (m <sup>2</sup> )	Product code
1.5	2500	800	80	Supplied individually		511060
1.5	2500	1000	100	Supplied individually		505857

All dimensions are nominal

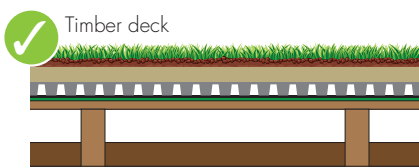

Timber deck

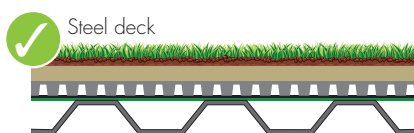

Steel deck

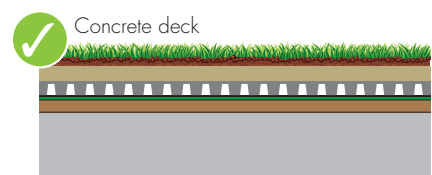

Concrete deck

Contact our Technical Support Team on 01744 766 666 for more information.

Note: Urbanscape® Green Roof System will not affect U-values of roofs but it can contribute significantly to the efficient design of drainage.

## CONTACTS

### Technical Support Team

01744 766 666

[technical.uk@knaufinsulation.com](mailto:technical.uk@knaufinsulation.com)

### Literature

[info.uk@knaufinsulation.com](mailto:info.uk@knaufinsulation.com)

### Find your local sales representative

[knaufinsulation.co.uk/contact-finder](http://knaufinsulation.co.uk/contact-finder)

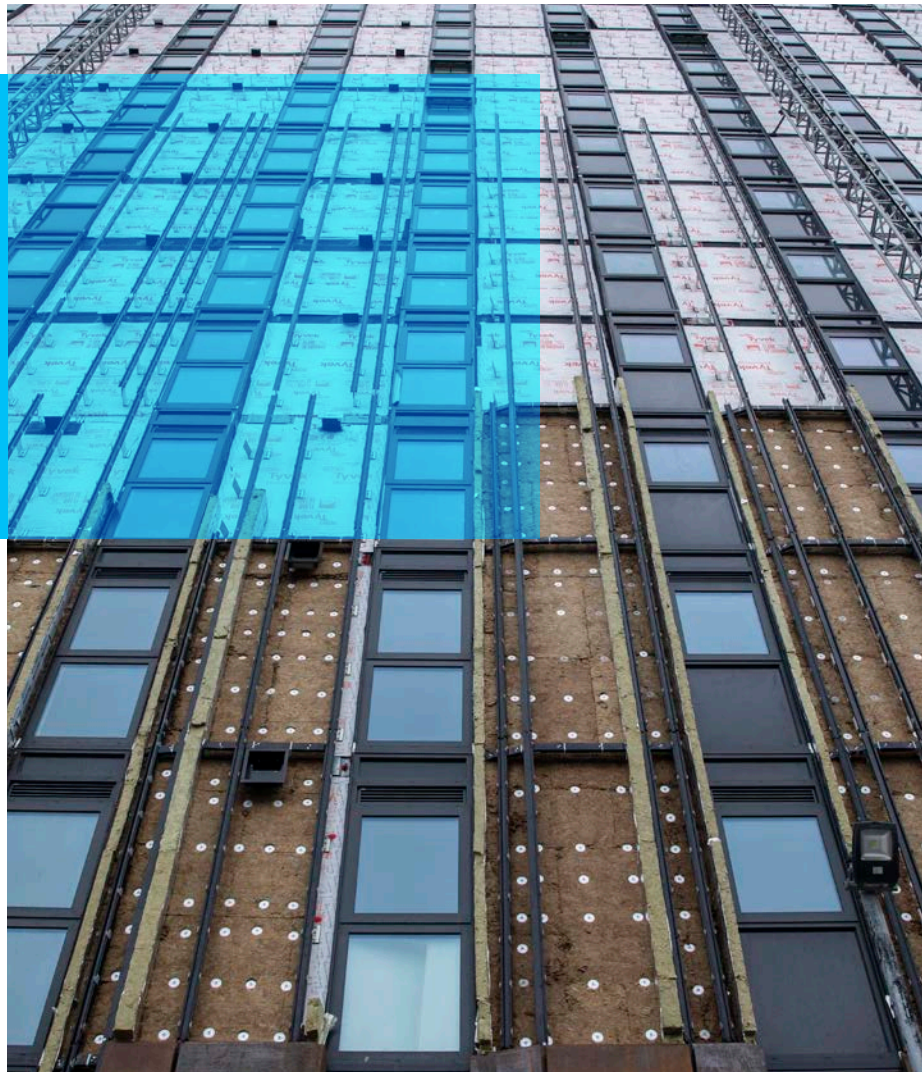

**Knauf Insulation Ltd** PO Box 10, Stafford Road, St.Helens, Merseyside, WA10 3NS. UK

For more information please visit [knaufinsulation.co.uk](http://knaufinsulation.co.uk)

All rights reserved, including those of photomechanical reproduction and storage in electronic media. Extreme caution was observed when putting together and processing the information, text and illustrations in this document. Nevertheless, errors cannot be completely ruled out. The publisher and editors cannot assume legal responsibility or any liability for incorrect information and consequences thereof. The publisher and editors will be grateful for improvement suggestions and details of possible errors pointed out. For the most up-to-date document versions and product information, please always refer to our website.

challenge.  
create.  
care.