



Technical Data

13 Amp Socket Outlet

Brief product description:

The subtle design will blend with any décor - suitable for domestic or commercial installations.

Features:

- White moulded round edge, sleek and slim with softly rounded edges
- Power socket for standard 3 pin UK plug
- Easy to install, supplied with fixing screws and installation instructions
- Angled in-line colour coded terminals with backed out screws for fast installation
- Screw cover caps for a sleek appearance
- Twin earth fitted as standard for high integrity circuits
- Anti-microbial certified - manufactured using high grade thermoset Urea which effectively inhibits the growth of infectious diseases, including MRSA, E-Coli, Salmonella and Klebsiella Pneumonia bacteria

Product Images



821/821DP

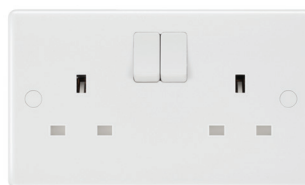
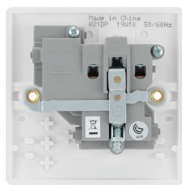

822/822DP

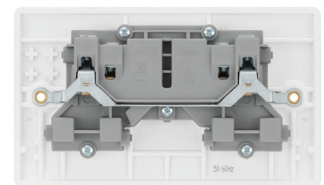

823

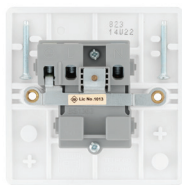

824

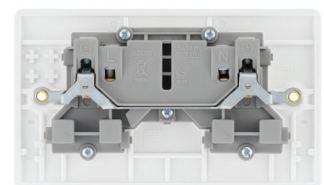

825

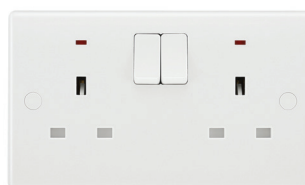
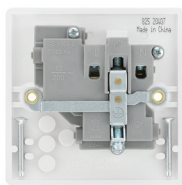

826

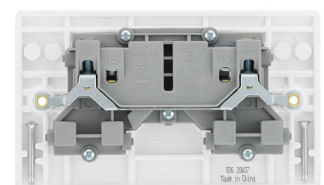

822DPOB

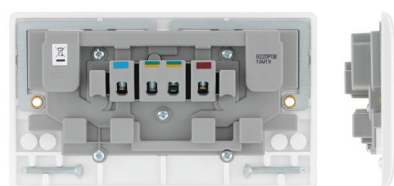



13 Amp Socket Outlet

Technical Specifications

Standard(s)	BS 1363-2:2016+A1:2018
Rating	13 Amp 250V AC
Switch Type	Single pole (821, 822, 825, 826 products) Double pole (821DP, 822DP, 822DPOB)
Terminal Capacity	3 x 2.5mm ² 3 x 4mm ² 2 x 6mm ²
RoHS Directive	Yes
WEEE Directive	Yes
Mounting Box Depth (Min)	25mm
Fixing Centres	60.3mm (821, 821DP, 823, 825 products) 120.6mm (822, 822DP, 822DPOB, 826 products)



Line Diagrams

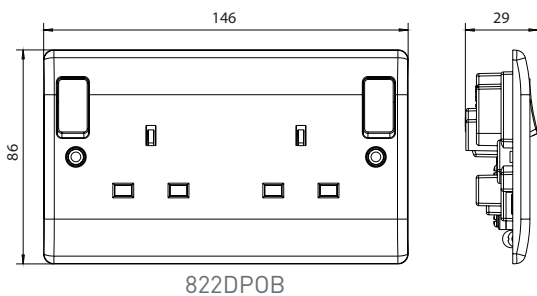
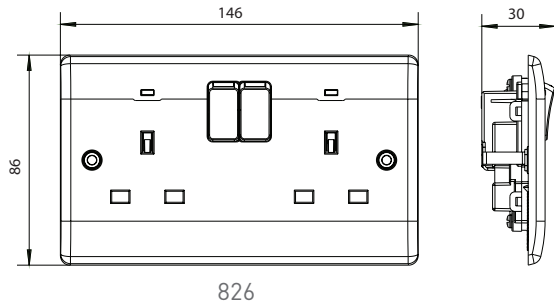
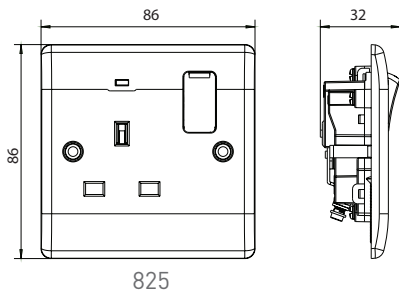
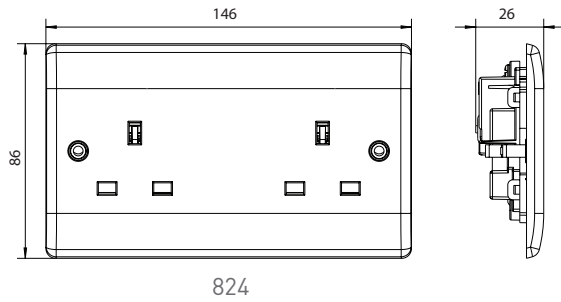
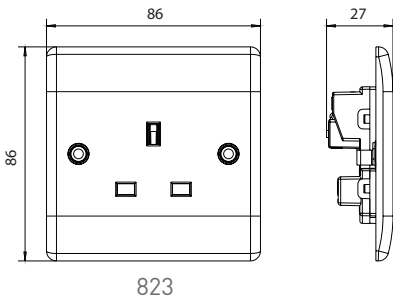
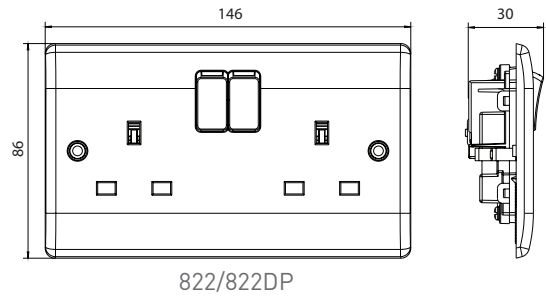
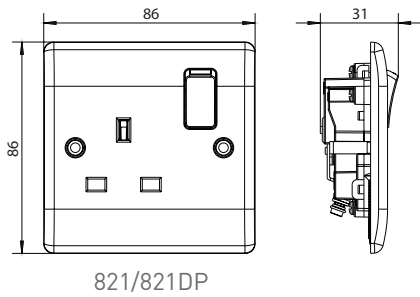



13 Amp Socket Outlet

Packaging Information

Cat No.	Description	Packaging Type			Pack Quantity			Barcode		
		Product	Inner Box	Outer Box	Each	Inner Box	Outer Box	Individual	Inner Box	Outer Box
821	13A 1G SP, SW SKT	Printed Bag	Printed Carton	Printed Carton	1	10	100	5050765000550	5050765000567	5050765000574
821DP	13A 1G DP, SW SKT	Printed Bag	Printed Carton	Printed Carton	1	10	100	5050765000581	5050765000598	5050765000604
822	13A 2G SP, SW SKT	Printed Bag	Printed Carton	Printed Carton	1	5	50	5050765000611	5050765000628	5050765000635
822DP	13A 2G DP, SW SKT	Printed Bag	Printed Carton	Printed Carton	1	5	50	5050765000642	5050765000659	5050765000666
822DPOB	13A 2G DP OB SW SKT	Printed Bag	Printed Carton	Printed Carton	1	5	50	5050765018128	5050765106610	5050765106627
823	13A 1G SKT	Printed Bag	Printed Carton	Printed Carton	1	10	100	5050765000673	5050765000680	5050765000697
824	13A 2G SKT	Printed Bag	Printed Carton	Printed Carton	1	5	50	5050765000703	5050765000710	5050765000727
825	13A 1G SW SKT+ LED	Printed Bag	Printed Carton	Printed Carton	1	10	100	5050765000734	5050765000741	5050765000758
826	13A 2G SW SKT+ LED	Printed Bag	Printed Carton	Printed Carton	1	5	50	5050765000765	5050765000772	5050765000789

Weights & Dimensions

Cat No.	Description	Dimensions (H x W x D) cm				Weight (kg)				CBM (m ³)
		Unpacked Product	Packed Product	Inner Box	Outer Box	Unpacked Product	Packed Product	Inner Box	Outer Box	Outer Box
821	13A 1G SP, SW SKT	8.6 x 8.6 x 3.1	16.5 x 11 x 3.4	9.5 x 18.2 x 14.7	19.6 x 48.8 x 30.8	0.094	0.098	1.05	10.93	0.02946
821DP	13A 1G DP, SW SKT	8.6 x 8.6 x 3.1	16.5 x 11 x 3.4	9.5 x 18.2 x 14.7	19.6 x 48.8 x 30.8	0.078	0.082	1.06	10.93	0.02946
822	13A 2G SP, SW SKT	8.6 x 14.6 x 3	23 x 11 x 3.4	9.5 x 15.2 x 14.7	16.6 x 48.8 x 31	0.078	0.083	0.88	9.11	0.02511
822DP	13A 2G DP, SW SKT	8.6 x 14.6 x 3	23 x 11 x 3.4	9.5 x 15.2 x 14.7	16.6 x 48.8 x 31	0.078	0.163	0.89	9.05	0.02639
822DPOB	13A 2G DP OB SW SKT	8.6 x 14.6 x 2.9	23 x 11 x 3.1	9.5 x 15.2 x 14.7	16.6 x 48.8 x 31	0.078	0.083	0.88	9.13	0.02511
823	13A 1G SKT	8.6 x 8.6 x 2.7	16.5 x 11 x 2.8	9.5 x 18.2 x 14.7	19.6 x 48.8 x 30.8	0.078	0.093	0.99	10.21	0.02946
824	13A 2G SKT	8.6 x 14.6 x 2.6	23 x 11 x 2.7	9.5 x 15.2 x 14.7	16.6 x 48.8 x 31	0.078	0.082	0.80	8.34	0.02511
825	13A 1G SW SKT+ LED	8.6 x 8.6 x 3.2	16.5 x 11 x 3.4	9.5 x 18.2 x 14.7	19.6 x 48.8 x 30.8	0.078	0.082	0.94	9.73	0.02946
826	13A 2G SW SKT+ LED	8.6 x 14.6 x 3	23 x 11 x 3.4	9.5 x 15.2 x 14.7	16.6 x 48.8 x 31	0.078	0.083	0.80	8.31	0.02511