

Civils & Infrastructure

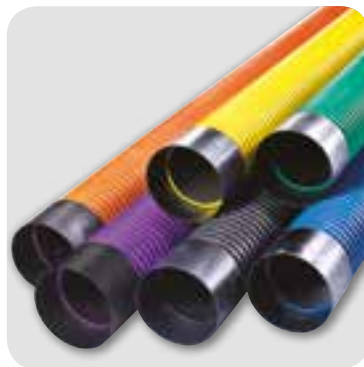
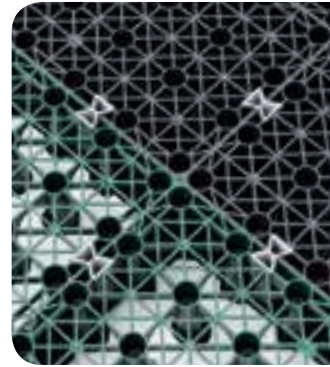

Product Guide

Welcome to Polypipe

At Polypipe, conceiving, designing, manufacturing and delivering the most advanced products and systems is more than just an occupation. We see it as our passion. Everything we do has always been based around a few simple beliefs: Quality always beats quantity. Products are nothing without service and support. Sustainability isn't just a 'green' word and working with our customers is much better than simply supplying them.

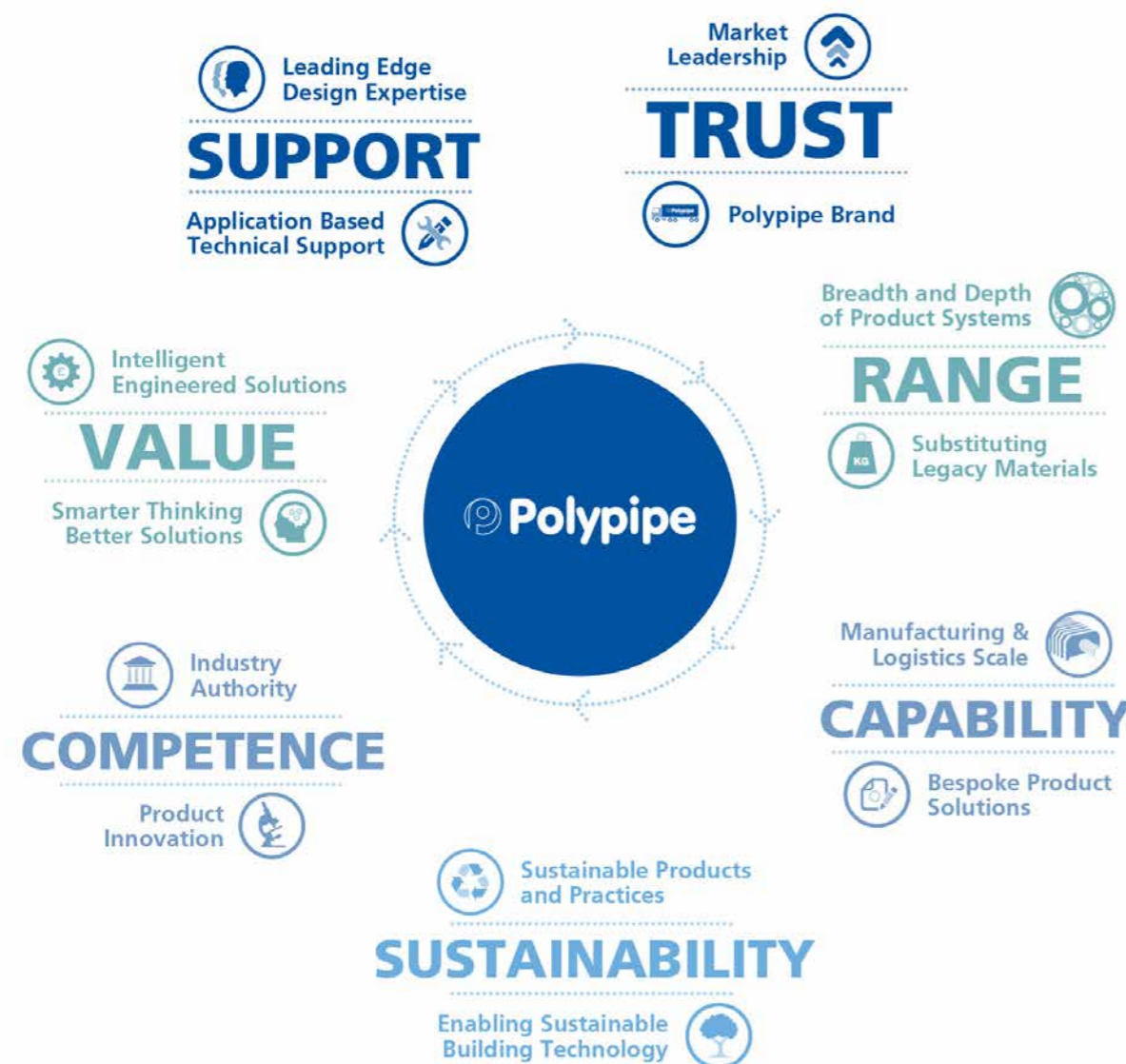

Our products offer unrivalled choice and quality. With water management, sewerage and cable protection systems, we offer the industry's widest choice of plastic piping and geocellular solutions.

Serving commercial, industrial, retail, infrastructure, residential and utilities markets, our commitment to innovative product solutions is unmatched. Our focus on continued investment in people, plant and product research helps to meet and exceed standards for performance and reliability in the UK market.

How to use this brochure

This product guide has been designed to provide you with quick, easy access to information on all of our Polypipe products and systems. A clear colour-coded navigation divides the guide into sections, each with its own introduction, followed by sub-contents segments that break down products by application and function.

Contents

| | | |
|-------------------|--|-----------|
| SECTION 1 | Polypipe Civils | |
| | Company Overview | 4 - 5 |
| | Technical services and support | 6 - 7 |
| | Our markets | 8 - 9 |
| | Plastics vs legacy materials | 10 - 11 |
| | The growing importance of SuDS | 12 - 13 |
| | Legislation and regulations | 14 |
| | Process integration | 15 |
| | The complete picture for Water Management and Civils and Infrastructure projects | 16 - 17 |
| | Drainage and SuDS – selection and design | 18 - 19 |
| SECTION 2 | Ridgidrain | |
| | Overview | 20 - 21 |
| | Ridgidrain pipes | 22 |
| | Ridgidrain end caps, seals & couplings | 23 |
| | Ridgidrain bends & junctions | 24 - 26 |
| | Ridgidrain reducers, spigots & sockets | 27 |
| | Gullies | 28 - 29 |
| | Linflex Fin and Narrow Filter Drains | 30 |
| | Ridgitreat | 31 |
| | Case studies | 32 - 33 |
| SECTION 3 | Ridgistorm-XL | |
| | Overview | 34 - 35 |
| | Ridgistorm-XL applications | 36 - 39 |
| | Ridgistorm-XL piping system | 40 - 41 |
| | Ridgistorm-XL jointing options | 42 - 43 |
| | Case studies | 44 - 45 |
| SECTION 4 | Fabrications | |
| | Overview | 46 - 47 |
| | RIDGISTORMCheck Vortex Flow Control Chamber | 48 |
| | RIDGISTORMCheck Orifice Plate Flow Control Chamber | 49 |
| | RIDGISTORMControl Penstock and Valve Chamber | 50 |
| | RIDGISTORMAccess Manholes | 51 |
| | RIDGISTORMSeparate Silt Traps | 52 |
| | RIDGISTORMSeparate Catchpits | 53 |
| | RIDGISTORMSeparate Weir and Baffle Chamber | 54 |
| | RIDGISTORMSeparate Filter Chamber | 55 |
| | RIDGISTORM-X4 Stormwater Treatment System | 56 |
| | Ridgistorm-XL Lifting Points | 57 |
| | Ridgistorm-XL Low Flow Channel | 58 |
| | Ridgistorm-XL Chamber Accessories | 59 |
| SECTION 5 | Geocellular | |
| | Overview | 60 - 61 |
| | The Permavoid system | 62 - 63 |
| | Permavoid applications | 64 - 65 |
| | Permavoid system components | 66 - 69 |
| | Permavoid 85 & 150 | 70 |
| | Permachannel | 71 |
| | Permavoid Biomat | 72 |
| | Permafilter Geotextile | 73 |
| | Polystorm range | 74 - 75 |
| | An 8 step guide to a total Polystorm system | 76 - 79 |
| | Polystorm Lite | 80 |
| | Polystorm-R | 81 |
| | Polystorm | 82 |
| | Polystorm Xtra | 83 |
| | Polystorm Access | 84 |
| | Polystorm Inspect | 85 |
| | Permavoid case studies | 86 - 87 |
| | Polystorm case studies | 88 - 89 |
| SECTION 6 | Rainwater harvesting | |
| | Overview | 90 - 91 |
| | Rainstream | 92 - 93 |
| SECTION 7 | Land drainage | |
| | Overview | 94 - 95 |
| | Landcoil system | 96 - 97 |
| SECTION 8 | Sewer system | |
| | Overview | 98 - 99 |
| | Polysewer – pipes, fittings and accessories | 100 - 104 |
| | Sewer Saddles and Ridgisewer pipe | 105 |
| | Ridgisewer – fittings and accessories | 106 - 109 |
| SECTION 9 | Cable protection | |
| | Overview | 110 - 111 |
| | Power – Class 1 | 112 - 113 |
| | Power – Class 2 | 114 |
| | Power – Class 3 | 115 |
| | Ridgicoil power and power accessories | 116 - 117 |
| | General purpose power | 118 - 119 |
| | Motorway Comms | 120 - 121 |
| | Lighting | 122 - 125 |
| | Utilities | 126 - 129 |
| | Installation advice | 130 - 131 |
| SECTION 10 | The company | |
| | Overview | 132 - 133 |
| | Innovation and research | 134 - 135 |
| | Polypipe project and technical support | 136 - 137 |
| | Online technical resources | 138 - 139 |
| | Enabling sustainable building technology | 140 |
| | Literature | 141 |

Company overview

Polypipe is the UK market leader in the design, development and manufacture of plastic piping systems for civils and infrastructure projects.



Civils and Infrastructure

At Polypipe we provide advanced holistic solutions and unrivalled technical support to help our customers meet today's construction challenges. With our civil engineering expertise, we lead the way in replacing traditional materials like concrete or clay with high performance, engineered, thermoplastic solutions for a variety of project types. Whether it's a highway scheme such as the M25 road widening, an airport like Heathrow Terminal 5 or a capital works scheme such as Gulls Way in the Wirral for Welsh Water, we offer a comprehensive range of solutions, including surface water drainage, sewerage systems, cable protection and water management solutions.

Water management solutions

The demand for comprehensive water management solutions has never been more pressing. Extreme rainfall events, driven by climate change, are becoming more frequent. In response, the Government has introduced new legislation. The Floods and Water Management Act 2010 sets out new ways to manage surface water via sustainable drainage systems (SuDS). We have responded to this challenging market by developing intelligently engineered, holistic water management solutions. These include geocellular and large diameter pipe systems for retention, attenuation and infiltration applications, surface water treatment products and rainwater re-use solutions, all supported by in-house Design, Technical, Fabrication and Product Support Teams.

Contents

| SECTION 1 | Polypipe Civils | |
|-----------|--|---------|
| | The company overview | 4 - 5 |
| | Technical services and support | 6 - 7 |
| | Our markets | 8 - 9 |
| | Plastics vs legacy materials | 10 - 11 |
| | The growing importance of SuDS | 12 - 13 |
| | Legislation and regulations | 14 |
| | Process integration | 15 |
| | The complete picture | 16 - 17 |
| | Drainage and SuDS – Selection and design | 18 - 19 |

Technical services and support

Our industry expertise and knowledgeable Technical Solutions Team allow us to provide an unrivalled level of technical support for your project.



We work closely with our customers to help guide them through current legislation and complex building regulations. We also assist in selecting the right product ranges to meet with individual project requirements and can help develop a fully engineered system for more challenging project needs.

The calibre of our people

We place a huge emphasis on the knowledge and experience of the people we employ, offering unparalleled customer service to ensure your project receives the best possible solution. Our team includes fully qualified design engineers who offer detailed specification guidance and both fabrication and installation specialists. We are also members of influential bodies such as the British Plastics Federation and Construction Products Association and work closely with organisations such as DEFRA, CIRIA and Constructing Excellence, ensuring we are always closely involved with industry drivers.

Design

From the outset, our Design Team bring their technical expertise and experience to bear, providing assistance with hydraulic, structural and flotation calculations supported by system CAD designs and specifications.

Installation guidance

Providing guidance at the critical installation stage, co-ordinating deliveries and ensuring the most cost and time efficient pathways to completion.

Bespoke fabrication

We are unique in having our own in-house fabrication unit. In the 2600m² facility, our skilled and highly experienced technicians deliver modular engineered drainage and water management systems. These are provided ready-to-install, maximising the benefits of pre-fabrication, for ease of delivery and reduced installation time on-site.

Guidance and support

We are here to offer you the support you need at every stage of your project. Our extensive product literature, including product datasheets and technical manuals, are readily available from our website www.polypipe.com/toolbox or you can call our Technical Team for a rapid response to all enquiries on **+44 (0) 1509 615100**.

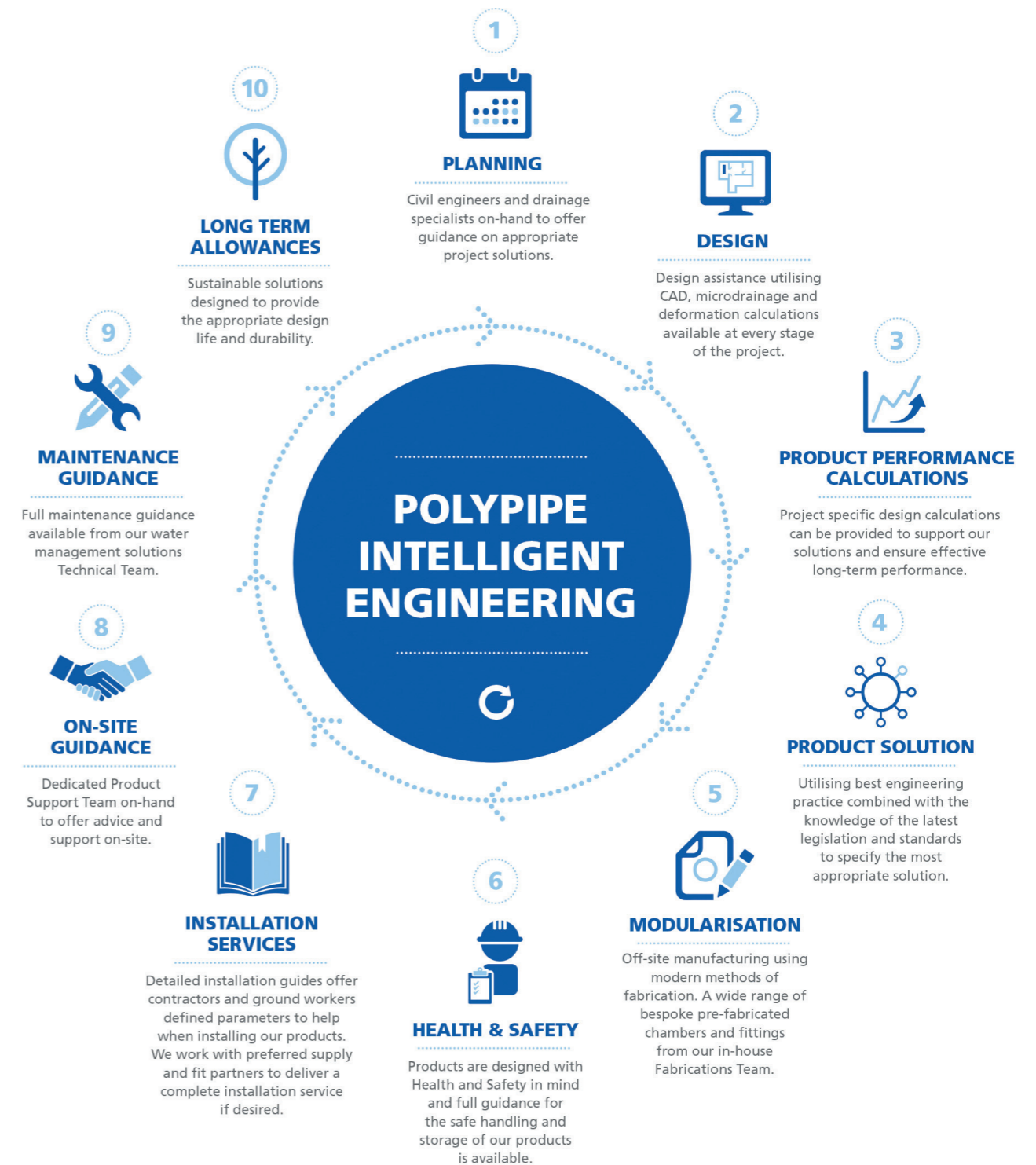

Our markets

At Polypipe, we pride ourselves on the versatility of our product range, providing systems and solutions to the commercial, industrial, retail, infrastructure, residential and utilities market sectors.



Commercial and Public

We provide complete solutions for a range of commercial, public, industrial and retail projects with product solutions engineered for large commercial buildings, schools, hospitals, car parks, shopping centres and industrial developments. We have innovative products and systems for every project – from below ground ventilation, sewer and drainage systems to managing surface water, storing and reusing it as an alternative to mains supply.

Rail

Our trackside and station solutions for surface water drainage, water management and cable protection have been installed in a number of important rail infrastructure projects such as London Bridge Station. Our products and systems are designed to ensure a quick installation to minimise track closures, improve Health and Safety during handling and installation and where possible, they carry Network Rail PADS approval.

Power

Polypipe is the UK's leading supplier to the power utilities industry and our products are favoured by Distribution Network Operations (DNO) companies. Our range includes cable protection that complies with ENATS 12-24 Classes 1, 2 and 3 as well as above ground solutions, such as Cable Guards and Hockey Sticks.

Roads and Highways

We offer a full range of both surface water drainage and cable protection BBA HAPAS approved systems, conforming to Highways England standards and specifications to meet the needs of motorways and highway projects. Our Ridgidrain surface water drainage system is quick to install due to being lighter in weight and available in longer lengths, compared to concrete alternatives, speeding up installation to reduce road/lane closures. Our Motorway Comms cable protection systems are also quick and easy to install and come in longer lengths to minimise joints and the risk of water ingress.



Residential

We have a range of adoptable drainage, sewer and water management solutions to suit any size of development. Our Polysewer, Ridgisewer and Ridgistorm-XL piping systems offer a water company approved solution for Section 104 agreements. Whilst our Permavoid and Polystorm geocellular systems extend the choice for water management further and can be used in conjunction with soft SuDS to enhance the biodiversity of a development.

Water

We offer a complete range of chemical resistant piping systems to meet the requirements of the water industry, from smaller sized pipes such as Polysewer and Ridgisewer, to large diameter Ridgistorm-XL. Our systems are perfectly suited to surface water, sewer and combined sewer applications and are fully compliant with Sewers for Adoption, 7th Edition and are accepted for use by all UK water companies.

Ports and Harbours

We offer a range of drainage, water management and cable protection systems engineered for the requirements of airports, ports and harbours. Whether its capturing water, storing it, reusing it, or draining it away, all our products have been manufactured with a high degree of durability, versatility and strength – particularly for coping with increased traffic loading as well as carrying away high volumes of standing water on airport tarmacs.

Agriculture

Our Landcoil land drainage pipe range is designed to aid the successful management of land water. In addition, Ridgistorm-XL, Ridgidrain and Ridgitreat can be used in trench and French drain applications to collect, treat and infiltrate water or take it to another area.

Plastics vs legacy materials

Using engineered plastics rather than traditional materials such as concrete or clay can lead to innovative project solutions that offer transportation, installation and cost-saving benefits.

Plastic pipe key benefits

- Lower density weight than legacy materials, lowering transport and installation costs
- Lower modulus means flexibility and reduced risk of breakage
- Strong and lighter weight providing excellent Health and Safety benefits
- Reduced leakage due to longer pipe lengths and high-integrity joint systems
- Can be manufactured from recycled materials
- Proven second life - 100% recyclable
- Ability to use off-site construction techniques to minimise cost and time on-site
- Non-corrosive
- Chemical resistant



On-site benefits

As thermoplastic pipes are inherently lighter in weight than legacy materials, they are quicker and easier to install. In many circumstances, lighter plant is required to install these products, providing cost savings on-site. Further cost savings are achieved as lighter plant removes the need for temporary access works and prevents damage to road surfaces. Thermoplastic pipes can be **70% cheaper to transport** than equivalent concrete pipes due to their longer lengths and lighter weight. Their lighter weight nature also provides excellent Health and Safety benefits when considering the storage and handling of pipes, making them beneficial to Construction Design Management (CDM) compliance.

Performance benefits

Typically, concrete pipes are usually supplied in 2.5m lengths. However, thermoplastic pipes can be supplied in lengths all the way up to 12m. Using these longer pipes ensures fewer joints are required along the pipeline, minimising any potential leakage points. In addition, these pipes have integral sockets, excellent jointing systems and are flexible, meaning they are more tolerant to movement of the surrounding soil than legacy pipes. This is a key factor when considering the Water Framework Directive (WFD) and Groundwater Directive legislation, which cites a reduction in diffuse pollution as a critical objective.

Environmental benefits

Thermoplastics are an integral part of sustainable developments. Lighter and more robust than most legacy materials, they typically **weigh up to 94% less** than their concrete equivalents. Due to this lighter weight nature, thermoplastic pipes and fittings help to reduce energy use and therefore greenhouse gas emissions. Thermoplastic pipes can also be transported in greater volumes than their concrete equivalents. For example, 1km of 450mm thermoplastic drainage pipes from Polypipe only requires three deliveries. Compare this to the twelve deliveries to site that concrete pipes would require, then the cost savings become apparent.

Not only will a reduced number of deliveries provide environmental benefits, but the reduction in vehicle movements on-site also ensures that the associated Health and Safety risks are reduced. We produce pipes and fittings utilising recycled materials where appropriate and all products are 100% recyclable at the end of their useful life.



The growing importance of SuDS

‘Making Space for Water’ is an integrated, forward-thinking strategy for managing future flood risk in England, first published in 2004.

Among its many recommendations is the adoption of a ‘joined-up’ approach to drainage management in high-risk urban areas and the widespread use of sustainable drainage systems (SuDS) to control the rate at which rainwater runs off paved areas and into sewer networks and rivers.

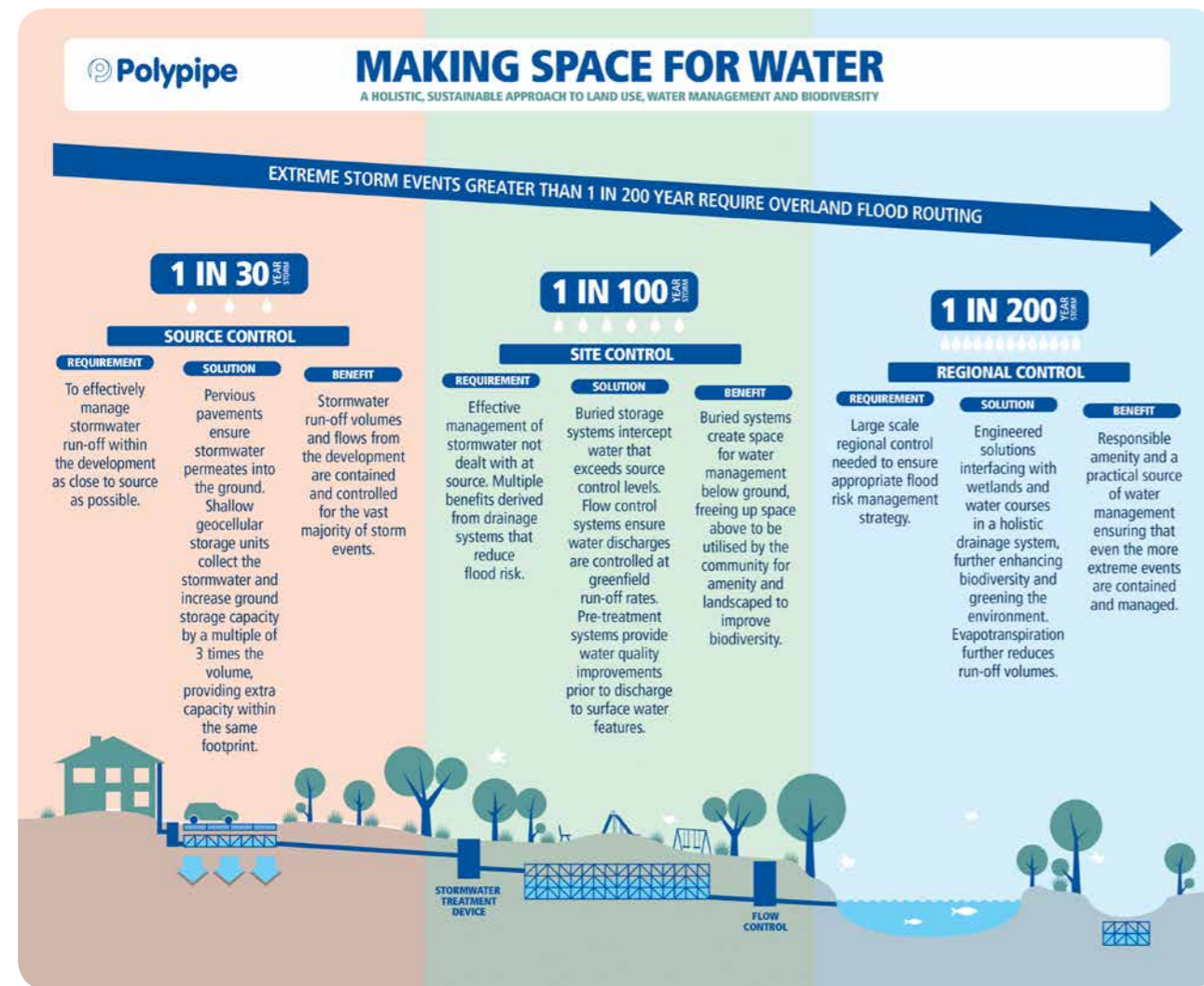

The challenge each developer faces, on both greenfield and brownfield developments, is what to do with the excess run-off generated by the development which has to be retained in and around the site. BS8533:2011, ‘Assessing and Managing Flood Risk in Development Code of Practice’, has been created to help designers analyse flood risk and to guide the selection of appropriate flood risk management solutions.

Soft SuDS alone may not provide sufficient storage on certain sites due to space constraints, particularly driven by the housing density requirements in PPS3:Housing. Our systems can help address these challenges, providing an effective controlled retention, attenuation or infiltration system to suit site specific requirements.

Government planning policy has defined the need for sustainable drainage systems (SuDS) to ensure that flood risk is taken into account during all stages of the planning process.

CIRIA (SuDS Manual)

The SuDS Manual provides guidance on all aspects of the design, construction, operation and maintenance of SuDS. In particular, it places a real emphasis on the use of source control techniques and requires designers to consider pollution removal.

The SuDS Manual defines that a sustainable drainage system should consider certain basic requirements, including:

- Run-off from a developed area should be no greater than the run-off prior to development
- Run-off from a developed area should not result in any down-grading of downstream watercourses or habitat
- Consideration should be given at the development feasibility stage to water resource management and control in the developed area
- Run-off should replicate as far as possible the natural response of the site to rainfall

Urbanisation has led to increasing negative impacts on the environment, in particular pollution. Depending on the land use, the following typical surface pollutants can be found in surface water run-off:

- Hydrocarbons and oils
- Sediments
- Heavy metals
- Fertilisers and pesticides
- Salts
- Animal wastes
- Pathogens

Traditionally, pollutants are collected from impermeable surfaces into the drainage systems and treated downstream via large, deep, in-line separators that are typically designed to treat the first ‘flush’ only. Emulsified oils and hydrocarbons can still be discharged downstream, the discharged oil and hydrocarbons constitutes a major pollution source and is a serious threat to groundwater sources.

The SuDS Management Train

This is a staged design concept used in sustainable drainage systems (SuDS) which controls volume and quality of surface water run-off.

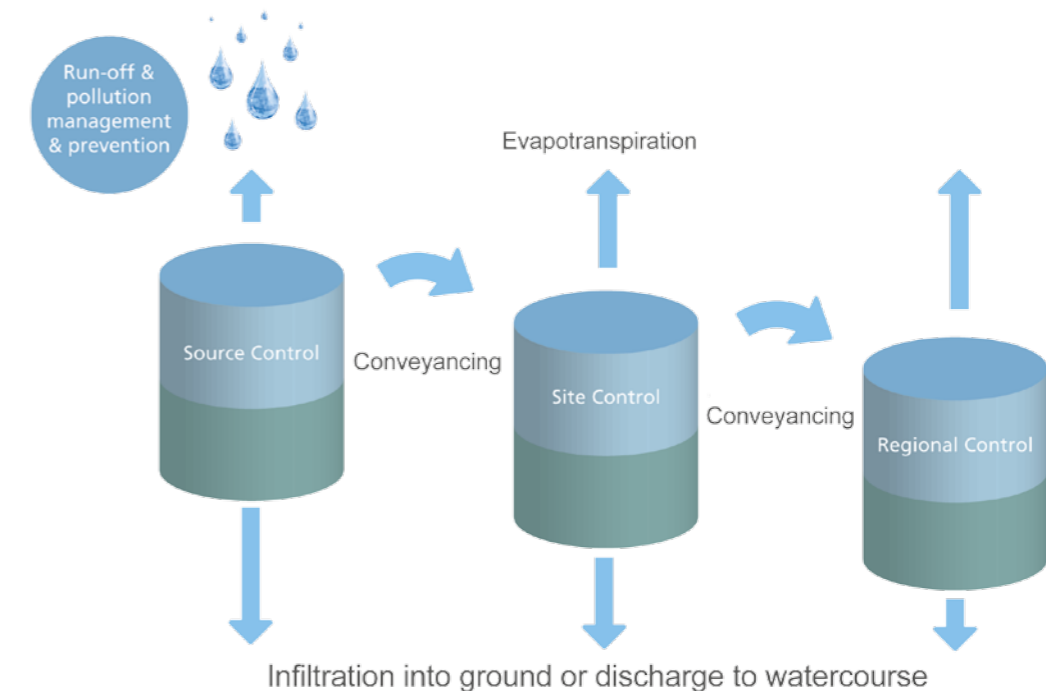

Legislation and regulations

We understand how important it is to keep up to date with legislation. That is why our advice and system selection is informed by the very latest regulations and standards.

Water Framework Directive

The Water Framework Directive (WFD) is a piece of EU legislation to improve water quality in watercourses and coastal areas. It identifies the treatment of pollution at source as one of the most effective ways of reducing pollution and improving water quality. Our geocellular solutions can meet that challenge by integrating a number of surface water treatment and water management control systems into your attenuation and soakaway structures at source.

Flood and Water Management Act 2010 (amended 2012)

The Flood and Water Management Act (FWMA) came into effect in 2010 with the aim to mitigate flood risk and improve water management. As part of the Act, Schedule 3 requires new developments to implement sustainable drainage systems (SuDS) on all new developments using natural and proprietary features in place of conventional drainage, to reduce surface water run-off, mitigate flood risk and improve water quality.

Building Regulations

Building Regulations Approved Document H3 requires rainwater to be either stored in a tank or discharged in the following order:

1. Soakaway or other infiltration
2. Rivers and watercourses
3. Direct to sewers

Many developments are being built on land that is not suitable for infiltration. Brownfield sites, sites with contaminated ground, high water tables, poor percolation and with natural aquifers are all examples of this. Rivers and watercourses are not always in close proximity/reasonable construction distance from the site, resulting in a very large number of sites still having to utilise mains sewer connections as their only viable means of stormwater discharge.

Lead Local Flood Authorities

The Flood and Water Management Act (FWMA) 2010 requires the Lead Local Flood Authority (LLFA) to be responsible for co-ordinating flood risk management within its area. They have the responsibility for managing the risk of flooding from surface water, groundwater and ordinary watercourses and for developing, maintaining and applying a strategy for local flood risk management. LLFA's are also responsible for maintaining a register of significant flood risk assets.

It is a requirement under the FWMA that LLFA's develop a local flood risk strategy focused on local issues. The strategy should incorporate effective and robust surface water drainage systems for new developments in accordance with SuDS principles.

National Planning Policy Framework (NPPF)

The NPPF requires that development is undertaken in a sustainable manner and has a presumption in favour of sustainable development. The systems should be designed to control surface water run-off close to where it falls and mimic natural drainage as closely as possible to:

- Reduce the causes and impacts of flooding
- Remove pollutants from urban run-off at source
- Combine water management with green space with benefits for amenity, recreation and wildlife

Information on how this should be applied is provided in the DEFRA non-statutory technical standards for sustainable drainage systems (SuDS).

Local Planning Authorities (LPAs)

When determining planning applications, LPAs should ensure that any new or redevelopment avoids flood risk to people and property, does not increase flood risk elsewhere and mitigates any flood risk taking into account of the impacts of climate change.

The LPA will be required to consult with the LLFA as a statutory consultee on major developments with surface water drainage requirements along with other statutory and non-statutory consultees as required.

Process integration

BS EN 782:2008

BS EN 782:2008 takes a more integrated view of designing sewer systems in the context of the wider urban drainage system and water environment. It helps engineers understand and implement integrated urban drainage systems and management. The National Annex provides information on how to incorporate BS EN 782:2008 practices within the UK.

BS 8582:2013

This Code of Practice is for surface water management for development sites. The standard has been developed to support:

- Planners and drainage approval bodies: In setting consistent drainage criteria and principles (for new

developments and redevelopments) that deliver effective surface water flood risk management as sustainably as possible, while contributing towards the delivery of relevant environmental, sustainability and urban design planning objectives for the site and local area.

- Designers: In planning and implementing safe, robust surface water management systems, that meet the criteria and principles referred to above.

In addition, this standard gives recommendations on the planning, design, construction and maintenance of surface water management systems for new developments and redevelopment sites, focusing on the sustainable management of flood risks arising from surface water run-off.

The diagram below demonstrates pertinent links between the development planning process and the drainage system design process, emphasising the involvement of stakeholders throughout.

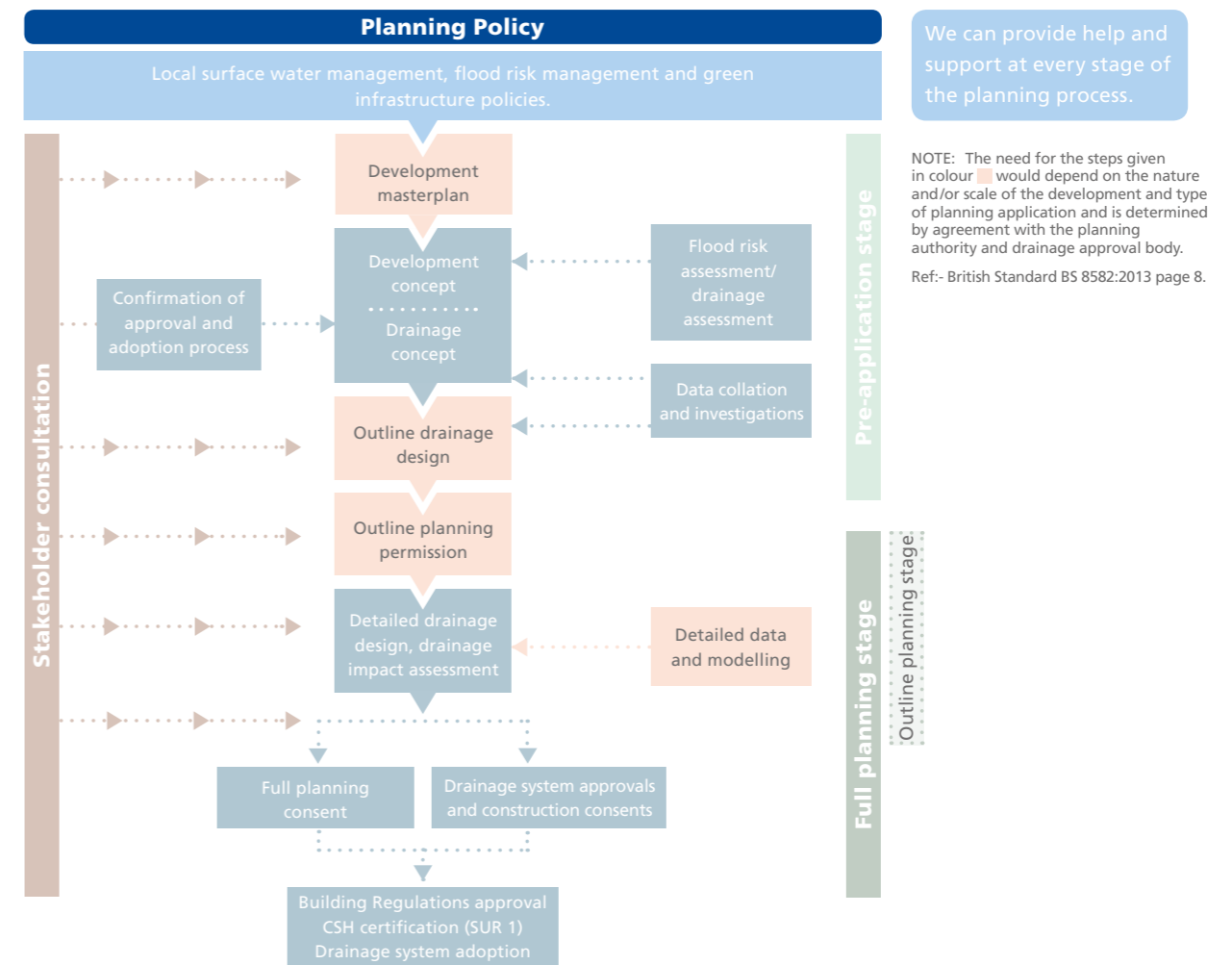

The complete picture for water management and civils and infrastructure projects

We offer the broadest range of plastic piping systems available in the UK. Our complete and comprehensive systems enable a one-stop approach to specification and technical support.

Covering everything from surface water management, treatment, attenuation and infiltration to sewerage and cable protection systems, our range takes into account the complete picture.



Permavoid
A sub-base replacement geocellular water management system for use at shallower depths.



Polystorm
A geocellular system used for retention, attenuation and infiltration at deeper depths.

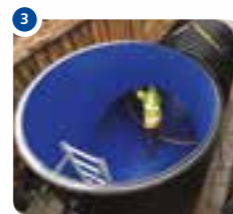

Ridgistorm-XL
An engineered, large diameter pipe solution for surface water, foul water and combined sewer applications.



Rainstream
Rainwater reuse systems for both commercial and residential applications.



Ridgidrain
A high strength HDPE surface water drainage piping system, used for surface and sub-surface drainage applications.



Polysewer
A PVCu sewer pipe system available in sizes 150-300mm.



Ridgisewer
A highly durable and versatile polypropylene sewer pipe system, available in sizes 400-600mm.

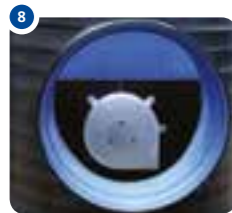

RIDGISTORM Check Chambers
Flow control chambers available with pre-fabricated Vortex Flow Controllers and Orifice Plates.

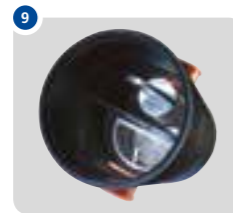

RIDGISTORM Separate
A range of upstream catchpits and silt traps to separate silt and other particles before entering a drainage system or the environment.



RIDGISTORM Control Chambers
A range of pre-fabricated chambers with flow control components such as Gate Valves, Flap Valves and Penstocks.



RIDGISTORM Access Manholes
Pre-fabricated manholes to provide easy access into a pipeline.



RIDGISTORM-X4
Advanced 4 stage water treatment system.



Landcoil
A land drainage system for the management of excess land water.

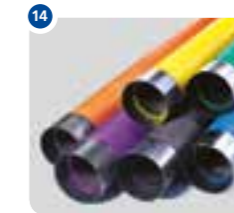

Cable protection
Protects cables and conduits carrying power, motorway communications, lighting and utilities in almost every application.

Drainage and SuDS - selection and design

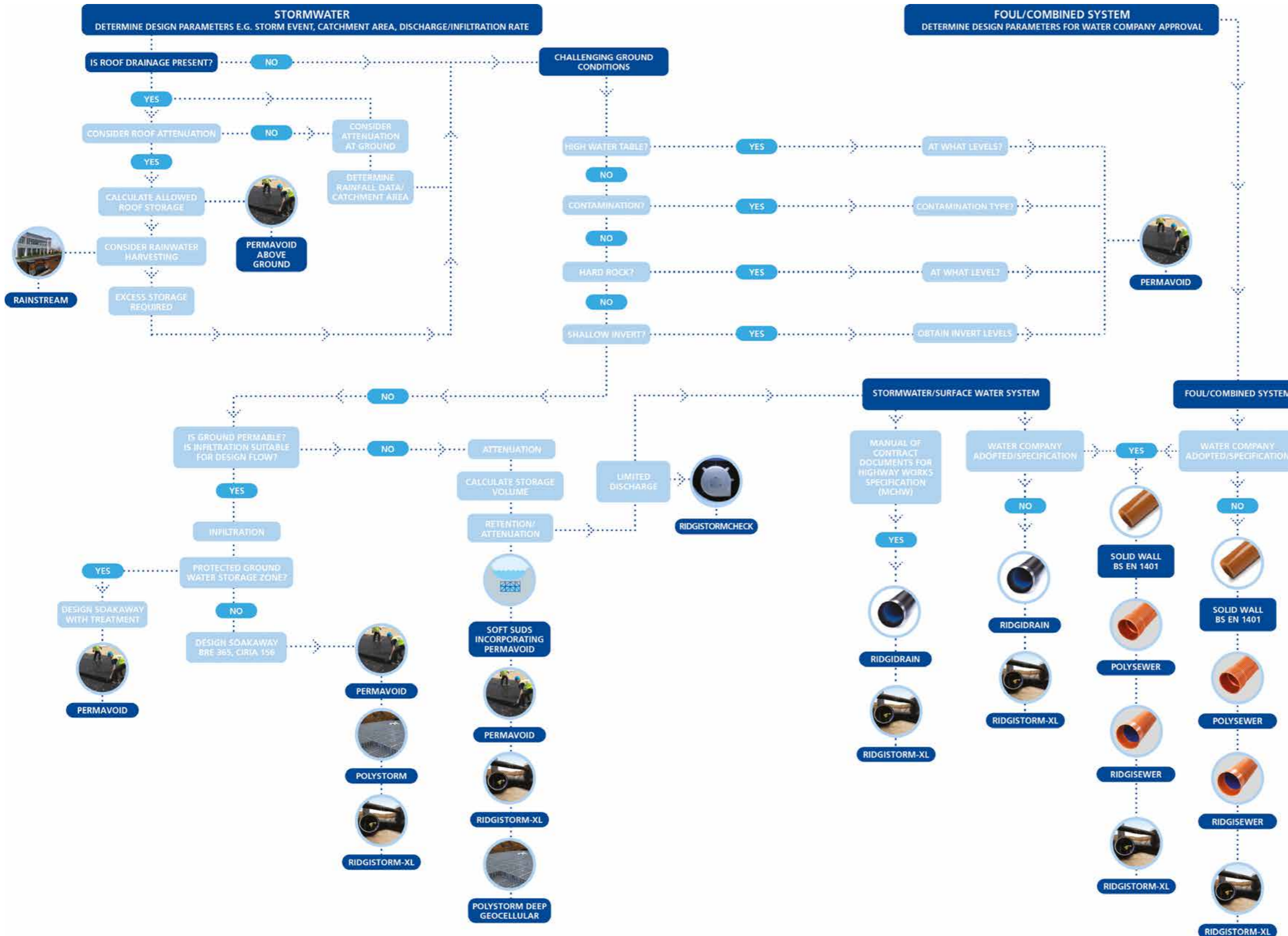

The right system for the right application

We manufacture modular sustainable drainage products and systems to suit site specific requirements. From Permavoid for rainwater interception and source control at shallower depths through to larger and deeper attenuation, infiltration and carrier systems for adoptable and non-adoptable stormwater systems.

This chart demonstrates all of our water management solutions available, to help determine which option best suits your particular site requirements.

Ridgidrain overview

Offering increased sustainability without compromise in performance, Ridgidrain is suitable for use in civils and infrastructure non-pressurised surface and sub-surface drainage applications.

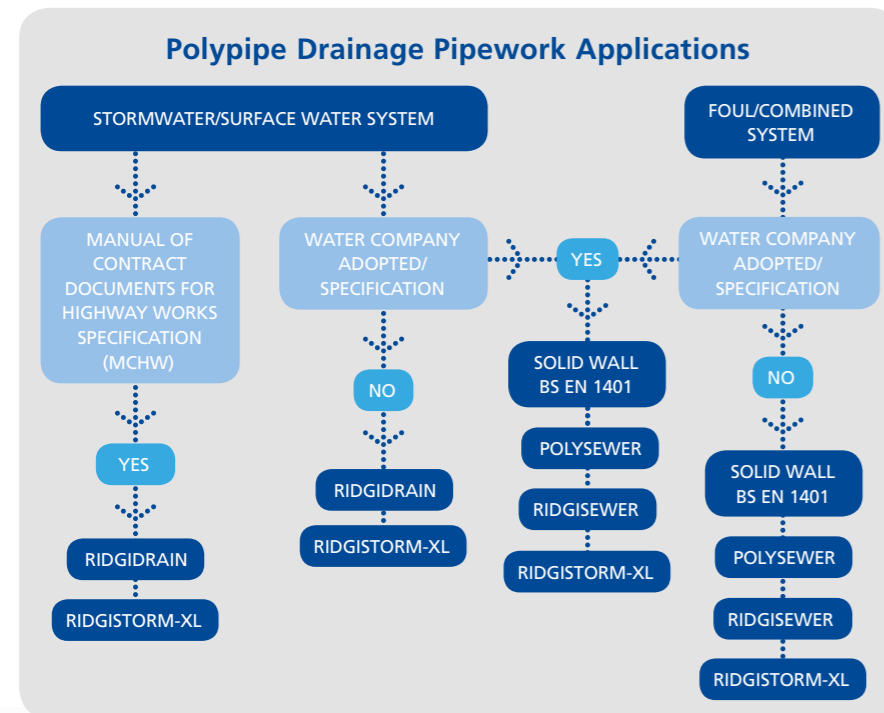

Ridgidrain key benefits

- Full range of pipes and fittings from 100-600mm
- BBA and BBA HAPAS approved
- Network Rail Parts and Drawing Systems (PADS) approved
- Structured wall design for high ring stiffness and strength
- Manufactured to SN6 with a predicted design life in excess of 60 years
- Non-pressure and leak tested up to 100mm/wg (0.01 bar)
- Smooth bore giving excellent hydraulic properties
- Longer lengths so fewer joints for improved resilience to leakage
- Light weight for reduced transport, installation costs and improved Health and Safety benefits
- Up to 94% lighter than concrete means fewer deliveries to site
- Reduces CO₂ consumed in production, transportation and on-site handling
- Manufactured from 100% recycled material
- Resistant to ground movement and differential settlement
- Integrally socketed in diameters 400-600mm for ease of installation
- Unperforated, half perforated and full perforated options available
- Ridgitrack is available for higher loading applications



High strength performance

The very first twinwall surface drainage system in the UK with Highways Authority Product Approval Scheme (HAPAS) status, Ridgidrain has a high strength to weight ratio and flexibility to resist high traffic loads. It has a low friction inner wall for improved hydraulics and comes in 6m lengths to significantly reduce the number of joints and risk of leakage. Made from 100% recycled high strength HDPE, using a structured wall design to produce a robust yet flexible pipe, Ridgidrain has a high resistance to the most common chemicals. It offers excellent performance, meaning you get all the benefits of sustainability, strength and lower weight without compromising on long term effectiveness.

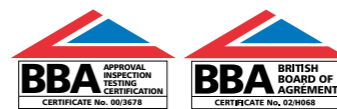

(BBA and HAPAS Approved)



(Network Rail Parts and Drawing Systems (PADS) Approved)
Certificate Number: PA05/05460

Applications

- Highways
- Rail
- Airports
- Residential
- Commercial
- Industrial
- Agricultural
- Education

Contents

| SECTION 2 | Ridgidrain | |
|-----------|--|---------|
| | Ridgidrain overview | 20 - 21 |
| | Ridgidrain pipes | 22 |
| | Ridgidrain end caps, seals & couplings | 23 |
| | Ridgidrain bends & junctions | 24 - 26 |
| | Ridgidrain reducers, spigots & sockets | 27 |
| | Gullies | 28 - 29 |
| | Linflex Fin and Narrow Filter Drains | 30 |
| | Ridgitreat | 31 |
| | Case studies | 32 - 33 |

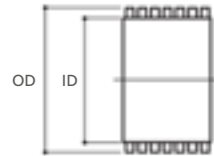

Ridgidrain plain ended pipe

Order seals separately if required,
1 coupler, 2 seals per length.



PA05/05460

| Ridgidrain Plain Ended Pipes | | | | | | | |
|------------------------------|----------------|-------|-------|----------|--------|--------------------------|----------|
| Nominal size mm | Code | ID mm | OD mm | Length m | Option | Weight kgm ⁻¹ | Pack qty |
| 100 | RD100X6PE* | 100 | 118 | 6 | U | 0.75 | 85 |
| 100 | RD100X6PEHP* | 100 | 118 | 6 | H | 0.75 | 85 |
| 100 | RD100X6PEP* | 100 | 118 | 6 | P | 0.75 | 85 |
| 150 | RD150X6PE/1 | 150 | 178 | 6 | U | 1.2 | 36 |
| 150 | RD150X6PEHP/1 | 150 | 178 | 6 | H | 1.2 | 36 |
| 150 | RD150X6PEP/1 | 150 | 178 | 6 | P | 1.2 | 36 |
| 225 | RD225X6PE/1 | 225 | 267 | 6 | U | 2.45 | 14 |
| 225 | RD225X6PEHP/1 | 225 | 267 | 6 | H | 2.45 | 14 |
| 225 | RD225X6PEP/1 | 225 | 267 | 6 | P | 2.45 | 14 |
| 300 | RD300X6PE/1 | 300 | 355 | 6 | U | 4.18 | 9 |
| 300 | RD300X6PEHP/1 | 300 | 355 | 6 | H | 4.18 | 9 |
| 300 | RD300X6PEP/1 | 300 | 355 | 6 | P | 4.18 | 9 |
| 375 | RD375X6PE/1 | 375 | 435 | 6 | U | 7.5 | 5 |
| 375 | RD375X6PEHP/1 | 375 | 435 | 6 | H | 7.5 | 5 |
| 375 | RD375X6PEP/1 | 375 | 435 | 6 | P | 7.5 | 5 |
| 400 | RD400X6PE/1▲ | 400 | 458 | 6 | U | 8.13 | 5 |
| 400 | RD400X6PEHP/1▲ | 400 | 458 | 6 | H | 8.13 | 5 |
| 400 | RD400X6PEP/1▲ | 400 | 458 | 6 | P | 8.13 | 5 |
| 450 | RD450X6PE/1▲ | 450 | 523 | 6 | U | 9.3 | 1 |
| 450 | RD450X6PEHP/1▲ | 450 | 523 | 6 | H | 9.3 | 1 |
| 450 | RD450X6PEP/1▲ | 450 | 523 | 6 | P | 9.3 | 1 |
| 500 | RD500X6PE/1▲ | 500 | 576 | 6 | U | 12.25 | 1 |
| 500 | RD500X6PEHP/1▲ | 500 | 576 | 6 | H | 12.25 | 1 |
| 500 | RD500X6PEP/1▲ | 500 | 576 | 6 | P | 12.25 | 1 |
| 600 | RD600X6PE/1▲ | 600 | 700 | 6 | U | 17.5 | 1 |
| 600 | RD600X6PEHP/1▲ | 600 | 700 | 6 | H | 17.5 | 1 |
| 600 | RD600X6PEP/1▲ | 600 | 700 | 6 | P | 17.5 | 1 |

Sizes 750-3000mm are available as Ridgistorm-XL, please see Section 3 for further information.

* Black inner wall.

▲ Made to order and subject to lead times.

U = Unperforated H = Half perforated P = Fully perforated

Weights are nominal.

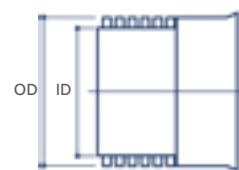

Ridgidrain integrally socketed pipe

Order seals separately if required, 1 per length.



PA05/05460

| Ridgidrain Integrally Socketed Pipes | | | | | | | |
|--------------------------------------|-------------|-------|-------|----------|--------|--------------------------|----------|
| Nominal size mm | Code | ID mm | OD mm | Length m | Option | Weight kgm ⁻¹ | Pack qty |
| 400 | RD400X6/1 | 400 | 458 | 6 | U | 8.0 | 5 |
| 400 | RD400X6HP/1 | 400 | 458 | 6 | H | 8.0 | 5 |
| 400 | RD400X6P/1 | 400 | 458 | 6 | P | 8.0 | 5 |
| 450 | RD450X6/1 | 450 | 523 | 6 | U | 9.0 | 1 |
| 450 | RD450X6HP/1 | 450 | 523 | 6 | H | 9.0 | 1 |
| 450 | RD450X6P/1 | 450 | 523 | 6 | P | 9.0 | 1 |
| 500 | RD500X6/1 | 500 | 576 | 6 | U | 12.0 | 1 |
| 500 | RD500X6HP/1 | 500 | 576 | 6 | H | 12.0 | 1 |
| 500 | RD500X6P/1 | 500 | 576 | 6 | P | 12.0 | 1 |
| 600 | RD600X6/1 | 600 | 700 | 6 | U | 14.0 | 1 |
| 600 | RD600X6HP/1 | 600 | 700 | 6 | H | 14.0 | 1 |
| 600 | RD600X6P/1 | 600 | 700 | 6 | P | 14.0 | 1 |

Sizes 750-3000mm are available as Ridgistorm-XL, please see Section 3 for further information.

U = Unperforated H = Half perforated P = Fully perforated

Weights are nominal.

| Internal End Caps | | |
|-------------------|-----------|----------|
| Nominal size mm | Code | Pack qty |
| 100 | EC1059INT | 10 |
| 150 | EC1778INT | 10 |
| 225 | EC5064INT | 10 |
| 300 | EC6010INT | 10 |

| External Sealable End Caps | | |
|----------------------------|---------|----------|
| Nominal size mm | Code | Pack qty |
| 100 | EC100 ▲ | 10 |
| 150 | EC150 ▲ | 10 |
| 225 | EC225 ▲ | 10 |
| 300 | EC300 ▲ | 10 |
| 375 | EC375 ▲ | 10 |
| 400 | EC400 ▲ | 10 |
| 450 | EC450 ▲ | 10 |
| 500 | EC500 ▲ | 10 |
| 600 | EC600 ▲ | 10 |

▲ Made to order and subject to lead times.

| Plastic Tub of Lubricant | | |
|--------------------------|---------|----------|
| Size kg | Code | Pack qty |
| 1 | LUBX1 | 12 |
| 2.5 | LUBX2.5 | 4 |

| Ridgidrain Seals | | |
|------------------|----------|----------|
| Nominal size mm | Code | Pack qty |
| 100 | SRD100 | 170 |
| 150 | SRD150 | 36 |
| 225 | SRD225 | 14 |
| 300 | SRD300 | 8 |
| 375 | SRD375 | 10 |
| 400 | SRD400/1 | 2 |
| 450 | SRD450/1 | 2 |
| 500 | SRD500/1 | 2 |
| 600 | SRD600/1 | 2 |

| Ridgidrain Nitrile Seals | | |
|--------------------------|---------------|----------|
| Nominal size mm | Code | Pack qty |
| 100 | SRD100NIT ▲ | 170 |
| 150 | SRD150NIT ▲ | 36 |
| 225 | SRD225NIT ▲ | 14 |
| 300 | SRD300NIT ▲ | 8 |
| 375 | SRD375NIT ▲ | 10 |
| 400 | SRD400NIT/1 ▲ | 2 |
| 450 | SRD450NIT/1 ▲ | 2 |
| 500 | SRD500NIT/1 ▲ | 2 |
| 600 | SRD600NIT/1 ▲ | 2 |

▲ Made to order and subject to lead times.
Typically used where soil contains certain chemicals. Please send soil reports to our Technical Team.

| Ridgidrain Double Socket Couplings | | | | |
|------------------------------------|------------|------|------|----------|
| Nominal size mm | Code | A mm | B mm | Pack qty |
| 100 | CRD100 | 140 | 133 | 43 |
| 150 | CRD150 | 185 | 186 | 18 |
| 225 | CRD225 | 260 | 289 | 7 |
| 300 | CRD300 | 280 | 379 | 3 |
| 375 | CRD375 | 335 | 460 | 1 |
| 400 | CRD400DS/1 | 400 | 475 | 1 |
| 450 | CRD450DS/1 | 435 | 540 | 1 |
| 500 | CRD500DS/1 | 489 | 589 | 1 |
| 600 | CRD600DS/1 | 560 | 719 | 1 |

Slip couplers available on request.



Ridgidrain internal end caps

Not suitable for air tests.
Manufactured from polyethylene.



Plastic tub of lubricant



Ridgidrain sealing rings

EPDM seals to BS EN 681:Part 1 as standard.
Optional nitrile seals are available, but may be subject to order quantities and lead times.



PA05/05460

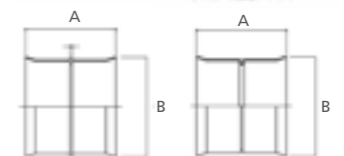

Ridgidrain double socket couplings

Order seals separately if required,
2 per coupler.



PA05/05460



Ridgidrain 11.25° & 15° bends
Order seals separately if required, 2 per bend.



PA05/05460



Ridgidrain 22.5° & 30° bends
Order seals separately if required, 2 per bend.



PA05/05460



Ridgidrain 45° bends
Order seals separately if required, 2 per bend.



PA05/05460

| Ridgidrain 11.25° & 15° Bends | | |
|-------------------------------|----------------|----------|
| Nominal size mm | Code | Pack qty |
| 100 | BRD100X11.25 | 10 |
| 150 | BRD150X15 | 10 |
| 225 | BRD225X11.25 | 1 |
| 300 | BRD300X11.25 | 1 |
| 375 | BRD375X11.25 | 1 |
| 400 | BRD400X11.25/1 | 1 |
| 450 | BRD450X11.25/1 | 1 |
| 500 | BRD500X11.25/1 | 1 |
| 600 | BRD600X11.25/1 | 1 |

Sizes 750-3000mm are available as Ridgistorm-XL, please see Section 3 for further information. Some bends are made to order and are subject to lead times.

| Ridgidrain 22.5° & 30° Bends | | |
|------------------------------|---------------|----------|
| Nominal size mm | Code | Pack qty |
| 100 | BRD100X22.5 | 10 |
| 150 | BRD150X30 | 10 |
| 225 | BRD225X22.5 | 1 |
| 300 | BRD300X22.5 | 1 |
| 375 | BRD375X22.5 | 1 |
| 400 | BRD400X22.5/1 | 1 |
| 450 | BRD450X22.5/1 | 1 |
| 500 | BRD500X22.5/1 | 1 |
| 600 | BRD600X22.5/1 | 1 |

Sizes 750-3000mm are available as Ridgistorm-XL, please see Section 3 for further information. Some bends are made to order and are subject to lead times.

| Ridgidrain 45° Bends | | |
|----------------------|-------------|----------|
| Nominal size mm | Code | Pack qty |
| 100 | BRD100X45 | 10 |
| 150 | BRD150X45 | 10 |
| 225 | BRD225X45 | 1 |
| 300 | BRD300X45 | 1 |
| 375 | BRD375X45 | 1 |
| 400 | BRD400X45/1 | 1 |
| 450 | BRD450X45/1 | 1 |
| 500 | BRD500X45/1 | 1 |
| 600 | BRD600X45/1 | 1 |

Sizes 750-3000mm are available as Ridgistorm-XL, please see Section 3 for further information. Some bends are made to order and are subject to lead times.

This brochure incorporates the most common bends and junctions. Bends and junctions incorporating other angles and diameters are available as specials. Manholes, catchpits, soakaways, ducting drawpits, pumping chambers and specialist items manufactured to customer specifications are also available. For further information, see Section 4 or contact our Technical Team on **+44 (0) 1509 615100**.

| Ridgidrain 87.5° & 90° Bends | | |
|------------------------------|-------------|----------|
| Nominal size mm | Code | Pack qty |
| 100 | BRD100X87.5 | 10 |
| 150 | BRD150X87.5 | 10 |
| 225 | BRD225X90 | 1 |
| 300 | BRD300X90 | 1 |
| 375 | BRD375X90 | 1 |
| 400 | BRD400X90/1 | 1 |
| 450 | BRD450X90/1 | 1 |
| 500 | BRD500X90/1 | 1 |
| 600 | BRD600X90/1 | 1 |

Sizes 750-3000mm are available as Ridgistorm-XL, please see Section 3 for further information. Some bends are made to order and are subject to lead times.

| 45° Ridgidrain Junctions | | | |
|--------------------------|-------------------|--------------|----------|
| Nominal size A mm | Nominal size B mm | Code | Pack qty |
| 100 | 100 | JRD100100Y | 10 |
| 150 | 100 | JRD150100Y | 5 |
| 150 | 150 | JRD150150Y | 5 |
| 225 | 100 | JRD225100Y | 1 |
| 225 | 150 | JRD225150Y | 1 |
| 225 | 225 | JRD225225Y | 1 |
| 300 | 100 | JRD300100Y | 1 |
| 300 | 150 | JRD300150Y | 1 |
| 300 | 225 | JRD300225Y | 1 |
| 300 | 300 | JRD300300Y | 1 |
| 375 | 100 | JRD375100Y | 1 |
| 375 | 150 | JRD375150Y | 1 |
| 375 | 225 | JRD375225Y | 1 |
| 375 | 300 | JRD375300Y | 1 |
| 375 | 375 | JRD375375Y | 1 |
| 400 | 100 | JRD400100Y/1 | 1 |
| 400 | 150 | JRD400150Y/1 | 1 |
| 400 | 225 | JRD400225Y/1 | 1 |
| 400 | 300 | JRD400300Y/1 | 1 |
| 400 | 400 | JRD400400Y/1 | 1 |
| 450 | 100 | JRD450100Y/1 | 1 |
| 450 | 150 | JRD450150Y/1 | 1 |
| 450 | 225 | JRD450225Y/1 | 1 |
| 450 | 300 | JRD450300Y/1 | 1 |
| 450 | 375 | JRD450375Y/1 | 1 |
| 450 | 450 | JRD450450Y/1 | 1 |
| 500 | 100 | JRD500100Y/1 | 1 |
| 500 | 150 | JRD500150Y/1 | 1 |
| 500 | 225 | JRD500225Y/1 | 1 |
| 500 | 300 | JRD500300Y/1 | 1 |
| 500 | 375 | JRD500375Y/1 | 1 |
| 500 | 400 | JRD500400Y/1 | 1 |
| 500 | 500 | JRD500500Y/1 | 1 |
| 600 | 100 | JRD600100Y/1 | 1 |
| 600 | 150 | JRD600150Y/1 | 1 |
| 600 | 225 | JRD600225Y/1 | 1 |
| 600 | 300 | JRD600300Y/1 | 1 |
| 600 | 450 | JRD600450Y/1 | 1 |
| 600 | 600 | JRD600600Y/1 | 1 |

Sizes 750-3000mm are available as Ridgistorm-XL, please see Section 3 for further information. Other sizes available on request. Some junctions are made to order and are subject to lead times.



Ridgidrain 87.5° & 90° bends
Order seals separately if required, 2 per bend.



PA05/05460

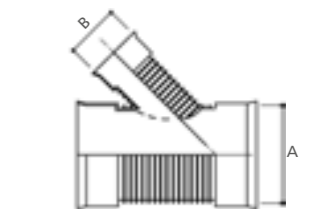

Ridgidrain 45° junctions
All junctions are triple socketed. Order seals and couplers separately.

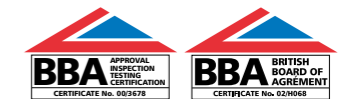

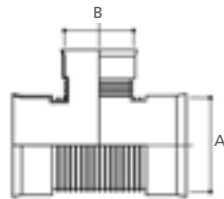

Ridgidrain 90° junctions

All junctions are triple socketed.
Order seals and couplers separately.



| 90° Ridgidrain Junctions | | | |
|--------------------------|-------------------|--------------|----------|
| Nominal size A mm | Nominal size B mm | Code | Pack qty |
| 100 | 100 | JRD100100T | 10 |
| 150 | 100 | JRD150100T | 10 |
| 150 | 150 | JRD150150T | 1 |
| 225 | 100 | JRD225100T | 1 |
| 225 | 150 | JRD225150T | 1 |
| 225 | 225 | JRD225225T | 1 |
| 300 | 100 | JRD300100T | 1 |
| 300 | 150 | JRD300150T | 1 |
| 300 | 225 | JRD300225T | 1 |
| 300 | 300 | JRD300300T | 1 |
| 375 | 100 | JRD375100T | 1 |
| 375 | 150 | JRD375150T | 1 |
| 375 | 225 | JRD375225T | 1 |
| 375 | 300 | JRD375300T | 1 |
| 375 | 375 | JRD375375T | 1 |
| 400 | 100 | JRD400100T/1 | 1 |
| 400 | 150 | JRD400150T/1 | 1 |
| 400 | 225 | JRD400225T/1 | 1 |
| 400 | 300 | JRD400300T/1 | 1 |
| 400 | 400 | JRD400400T/1 | 1 |
| 450 | 100 | JRD450100T/1 | 1 |
| 450 | 150 | JRD450150T/1 | 1 |
| 450 | 225 | JRD450225T/1 | 1 |
| 450 | 300 | JRD450300T/1 | 1 |
| 450 | 375 | JRD450375T/1 | 1 |
| 450 | 450 | JRD450450T/1 | 1 |
| 500 | 100 | JRD500100T/1 | 1 |
| 500 | 150 | JRD500150T/1 | 1 |
| 500 | 225 | JRD500225T/1 | 1 |
| 500 | 300 | JRD500300T/1 | 1 |
| 500 | 375 | JRD500375T/1 | 1 |
| 500 | 500 | JRD500500T/1 | 1 |
| 600 | 100 | JRD600100T/1 | 1 |
| 600 | 150 | JRD600150T/1 | 1 |
| 600 | 225 | JRD600225T/1 | 1 |
| 600 | 300 | JRD600300T/1 | 1 |
| 600 | 450 | JRD600450T/1 | 1 |
| 600 | 600 | JRD600600T/1 | 1 |

Sizes 750-3000mm are available as Ridgistorm-XL, please see Section 3 for further information.
Other sizes available on request. Some junctions are made to order and are subject to lead times.

Ridgidrain Level Invert Reducers

| Nominal size A mm | Nominal size B mm | Code |
|-------------------|-------------------|-------------|
| 150 | 100 | ARD150100 |
| 225 | 150 | ARD225150 |
| 300 | 150 | ARD300150 |
| 300 | 225 | ARD300225 |
| 375 | 225 | ARD375225 |
| 375 | 300 | ARD375300 |
| 400 | 150 | ARD400150/1 |
| 400 | 225 | ARD400225/1 |
| 400 | 300 | ARD400300/1 |
| 400 | 375 | ARD400375/1 |
| 450 | 150 | ARD450150/1 |
| 450 | 225 | ARD450225/1 |
| 450 | 300 | ARD450300/1 |
| 450 | 375 | ARD450375/1 |
| 450 | 400 | ARD450400/1 |
| 500 | 225 | ARD500225/1 |
| 500 | 300 | ARD500300/1 |
| 500 | 375 | ARD500375/1 |
| 500 | 400 | ARD500400/1 |
| 500 | 450 | ARD500450/1 |
| 600 | 100 | ARD600100/1 |
| 600 | 150 | ARD600150/1 |
| 600 | 225 | ARD600225/1 |
| 600 | 300 | ARD600300/1 |
| 600 | 375 | ARD600375/1 |
| 600 | 450 | ARD600450/1 |
| 600 | 500 | ARD600500/1 |

Some junctions are made to order and are subject to lead times.

Ridgidrain to BS EN 1401 Spigot and Socket

| Description | Code | Pack qty |
|--|-------------------|----------|
| 100mm Ridgidrain socket to 110mm BS EN 1401 spigot | ARD100110 | 10 |
| 150mm Ridgidrain socket to 160mm BS EN 1401 spigot | ARD150160 | 10 |
| 100mm Ridgidrain socket to 110mm BS EN 1401 socket | ARD100110 & UG401 | 10 |
| 150mm Ridgidrain socket to 160mm BS EN 1401 socket | ARD150160 & UG601 | 10 |

Order seals separately if required.

Ridgidrain to Super Clay Socket

| Description | Code | Pack qty |
|--|-------------------|----------|
| 100mm Ridgidrain socket to 100mm Super Clay socket | ARD100110 & UG434 | 10 |
| 150mm Ridgidrain socket to 150mm Super Clay socket | ARD150160 & UG634 | 10 |

Some sockets are made to order and subject to lead times.
Order seals separately if required.

Ridgidrain to Thick Clay Socket

| Description | Code | Pack qty |
|--|-------------------|----------|
| 100mm Ridgidrain socket to 100mm Thick Clay socket | ARD100110 & UG486 | 10 |
| 150mm Ridgidrain socket to 150mm Thick Clay socket | ARD150160 & UG696 | 10 |

Some sockets are made to order and subject to lead times.
Order seals separately if required.



Ridgidrain level invert reducers

Order seals separately if required.



PA05/05460



ARD150160



ARD100110



UG634



UG696



Ridgigully

A high quality, light, easy to handle and install alternative to heavy concrete gullies. Ridgigully is manufactured in durable HDPE in 3 sizes. Ridgigully is suitable for both trapped and untrapped systems with a 160mm spigot outlet as standard, which is easily adapted using the multi adaptor (ARG multi) to Ridgidrain, Polysewer and other pipe systems. A range of accessories are available, including gully risers that key into the gully and eliminate the need for brickwork to finish level.

Ridgigully key benefits

- Unique, patented screw thread corrugations
- Light in weight with superior strength
- Effective keying into the concrete surround
- Nested gullies lock together for easy handling, transportation and safer storage on-site
- BBA approved



(Applies to Ridgigully only)

| Ridgigully | | | | |
|---------------------|----------|-------------|-----------------|----------|
| Description | Code | Diameter mm | Capacity litres | Pack qty |
| 750mm Ridgigully | RG450750 | 450 | 80 | 16 |
| 900mm Ridgigully | RG450900 | 450 | 104 | 16 |
| BS EN 1401 Coupling | UG602 | 160 | - | - |
| Multi Adaptor | ARGMulti | - | - | 20 |



Ridgiflex

Ideal for flexible gully connections, 150mm single wall corrugated Ridgiflex has the same external profile as Ridgidrain. Available in 25m coils, it is compatible with standard Ridgidrain fittings.

| Ridgiflex Gully Connection Pipe | | | |
|---------------------------------|-------|----------|----------|
| ID mm | OD mm | Code | Length m |
| 150 | 178 | RF150X25 | 25 |



Midigully

Midigully is an ideally sized gully for domestic and smaller capacity industrial and commercial applications.

Midigully key benefits

- Manufactured in durable HDPE
- Spigot outlet, suitable for connection to 110mm BS EN 1401 sockets that can also be adapted to 100mm Ridgidrain
- Nested gullies lock together for easy handling, transportation and safer storage on-site
- A range of adaptors available
- Optional aluminium silt buckets and cast iron gratings

| Midigully | | | | |
|-----------|-------------|----------|-----------------|----------|
| Code | Diameter mm | Depth mm | Capacity litres | Pack qty |
| RG300600 | 300 | 600 | 24 | 36 |

| Midigully Accessories | |
|---------------------------|---------|
| Description | Code |
| 110mm BS EN 1401 coupling | UG402 ▲ |
| Silt Bucket | RGSB ▲ |
| Grating | RGG ▲ |

▲ Made to order and subject to lead times.



Gully Chute

Gully Chutes and large diameter gullies

Gully Chutes, larger diameter gullies and sumpless gullies are also available where larger flow rates are required, or an interface with slot drains or dished channels is required. For further information on our fabrication capabilities and benefits, please see Section 4, or contact our Technical Team on **+44 (0) 1509 615100**.

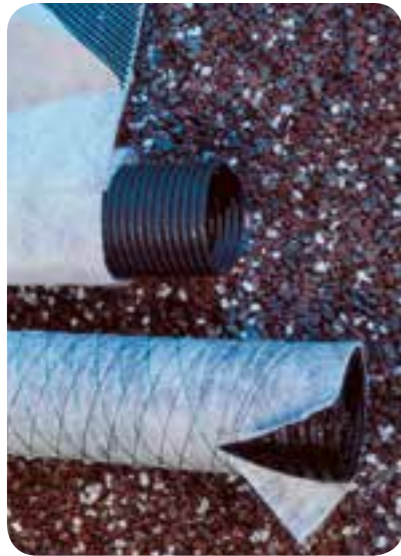

Linflex Fin and Narrow Filter Drains

Linflex Fin and Narrow Filter Drains provide drainage for both surface and sub-surface water. For applications where sub-surface only drainage is required, e.g. low capacity drainage for keeping water out of road structures, Fin and Narrow Filter Drains may be used as an alternative. These products are for use in edge-of-pavement drains for collection and/or disposal of sub-surface water in accordance with the requirements of Highways England.

Linflex Fin and Narrow Filter Drains key benefits

- Reduced requirement for aggregate
- Elimination of stone scatter by vehicles
- Reduced possibility of water logging of road base due to surface water inflow
- Manufactured to meet Highways England requirements (MCHW, Volume 3, Drawings F18, F19 and F20)
- Available in Type 6 and Type 8 configurations



Linflex Type 6 Fin Drain



Linflex Type 8 Narrow Filter Drain



Linflex Type 6 Fin Drain

PVCu perforated corrugated pipe to BS 4962:1989 supplied assembled with a composite plastic fin of two layers of geotextile separated by a plastic core. The geotextile is a non-woven fabric of heat-bonded polypropylene/polyethylene filaments. The product is delivered to site in a polyethylene protective wrapper for UV protection. Linflex Type 6 Fin Drain is manufactured in accordance with MCHW, Volume 1, sub-clause 514.

Linflex Type 6 Fin Drain

| Nominal size mm | Code | Length m | Fin Depth mm | Connector code |
|-----------------|-------------------|----------|--------------|----------------|
| 80 | FD80X12.5X600 ▲ | 12.5 | 600 | DC80M |
| 80 | FD80X12.5X750 ▲ | 12.5 | 750 | DC80M |
| 80 | FD80X12.5X900 ▲ | 12.5 | 900 | DC80M |
| 100 | FD100X12.5X600 ▲ | 12.5 | 600 | DC100M |
| 100 | FD100X12.5X750 ▲ | 12.5 | 750 | DC100M |
| 100 | FD100X12.5X1000 ▲ | 12.5 | 1000 | DC100M |
| 160 | FD160X12.5X600 ▲ | 12.5 | 600 | DC160M |
| 160 | FD160X12.5X750 ▲ | 12.5 | 750 | DC160M |

▲ Made to order and subject to lead times.

Linflex Type 8 Narrow Filter Drain

Single wall PVCu perforated corrugated pipe to BS 4962:1989 supplied in geotextile which is a non-woven fabric of heat-bonded polypropylene/polyethylene filaments. The product is delivered to site in a polyethylene protective wrapper for UV protection. Linflex Type 8 Narrow Filter Drain is manufactured in accordance with MCHW, Volume 1, sub-clause 515.

Linflex Type 8 Narrow Filter Drain

| Nominal size mm | Code | Length m | Connector code |
|-----------------|------------|----------|----------------|
| 60 | GE60150 ▲ | 150 | DC60 |
| 80 | GE80100 ▲ | 100 | DC80M |
| 100 | GE100100 ▲ | 100 | DC100M |
| 160 | GE16045 ▲* | 45 | DC160M |

▲ Made to order and are subject to lead times.
* Not BBA approved.

Ridgitreat

Ridgitreat surface water treatment pipes are designed to complement the existing Ridgidrain range when using a treatment infiltration solution. It comprises of a perforated HDPE plain ended Ridgidrain twinwall surface water pipework, wrapped in Permafilter Geotextile. The semi-permeable Permafilter Geotextile is engineered to catch, filter and break down hydrocarbon deposits such as oil and petrol from surface water, before infiltrating into the surrounding soil. The Permafilter geotextile provides a habitat for naturally occurring micro-organisms that feed on the trapped oil, removing pollutants through biodegradation, extending the product's design life beyond that which is expected with a generic geotextile. The oil retention capability is 800 ml/linear metre.

Applications

- Rail
- Commercial
- Car Parks
- Leisure
- Highways
- Retail



PA05/05460

(Approvals for Ridgidrain)

Ridgitreat key benefits

- A range of pipes and fittings available from 100-300mm
- Ridgidrain is BBA and BBA HAPAS approved
- Ridgidrain is Network Rail Parts and Drawing Systems (PADS) approved
- Captures residual hydrocarbons and removes pollutants by biodegradation
- Enhances water quality when used as part of a source control sustainable drainage system and eliminates the need for end of line petrol interceptors
- Structured wall design for high ring stiffness and strength
- Smooth bore giving excellent hydraulic properties
- EPDM sealing rings
- Longer lengths so fewer joints for improved resilience to leakage
- Light weight for reduced transport/installation costs and improved Health and Safety benefits
- Incorporates recycled plastic
- Resistant to ground movement and differential settlement



Microscopic view of self-maintaining eco-system

Oil retention capability is 800 ml/linear metre.

Ridgitreat Plain Ended Pipe

| Nominal size mm | Code | Length m | Weight kg | Connector code |
|-----------------|---------------|----------|-----------|----------------|
| 100 | RDT100X6PEP | 6 | 5 | CRD100 |
| 150 | RDT150X6PEP/1 | 6 | 7.5 | CRD150 |
| 225 | RDT225X6PEP/1 | 6 | 15 | CRD225 |
| 300 | RDT300X6PEP/1 | 6 | 25.5 | CRD300 |

Note: Please use Ridgidrain sealing rings for jointing, see page 23 for further information.

Case studies - M27, Junction 3-4 and 10-11 - Heathrow Terminal 5



M27 road widening scheme

We supplied Ridgidrain surface water drainage products for the widening of the M27 between Junctions 3-4 and 10-11 near Portsmouth, a £78m improvement scheme led by Costain on behalf of Highways England. Concrete pipes were originally considered, but as the works were taking place on a live highway they were deemed not the most appropriate option. This aided the specifier's decision to choose Polypipe due to the speed and ease of installation offered by plastic products. Ridgidrain, which includes an integral socket for faster installation, was used on the busiest sections of motorway to allow faster progress and reduce the danger to road crews. Polypipe and Costain have worked together on a number of road projects and our Technical Design and Product Support Teams again proved their ability to fabricate bespoke products and deliver them safely and economically to project timelines.

Heathrow Terminal 5

As partnering suppliers on the huge T5 project, we supplied main contractors AMEC and Laing O'Rourke with Ridgiduct and Ridgidrain products. Our Technical Design Team produced a one-off Ridgiduct design, complete with CAD Drawings, specifically for the project. This allowed couplers in the air ducting, that serves the air-side road tunnel, to be spaced every 12 metres instead of the usual 6. The result was a saving of 50% in coupling costs, along with significant savings in time, materials and labour. On projects such as T5, where even small savings are magnified by the sheer volumes involved, such close interaction between suppliers and contractors can have a huge impact on final costs.

Case studies - M4, Junction 13 - M25, Junctions 27 and 30



M4 Junction 13 improvement

We were appointed to design and deliver a drainage project that was easy to handle and quick to install within project timelines. The A34/M4 upgrade was a major infrastructure project and part of the Government's Targeted Programme for Improvement (TPI), involving 15,000m² of lime cement. Working closely with main contractor Costain, we provided a Ridgidrain structured-wall pipe system in diameters from 150mm to 450mm. Its excellent performance, longer lengths and effective jointing system meant it could be installed quickly and easily to save time and money on-site. We also provided cable protection ducting for communications, lighting and motorway signage. The long-term benefits of the upgrade can be seen in a marked improvement in carriageway drainage and substantially easier traffic flow.

M25 widening project

We provided 100,000m of surface water drainage products including Ridgidrain and large-diameter Ridgistorm-XL pipe, gullies and cable protection for street lighting and motorway communications. In addition to the Ridgistorm-XL and Ridgidrain products, we also teamed up with supply and fix partners, Stormwater Management Limited, to supply three separate off-line attenuation structures using our Polystorm modular cell system. These were installed in the soft-verge embankments to control surface water run-off from the carriageway. A total of 9330 Polystorm cells have been installed between Junctions 27 and 30.

Ridgistorm-XL overview

Ridgistorm-XL is an innovative large diameter piping system, available in sizes 750-3000mm in diameter. It can be used for a wide range of applications including surface water drainage, foul and combined sewers, large scale flood alleviation schemes and even displacement ventilation and renewable energy.

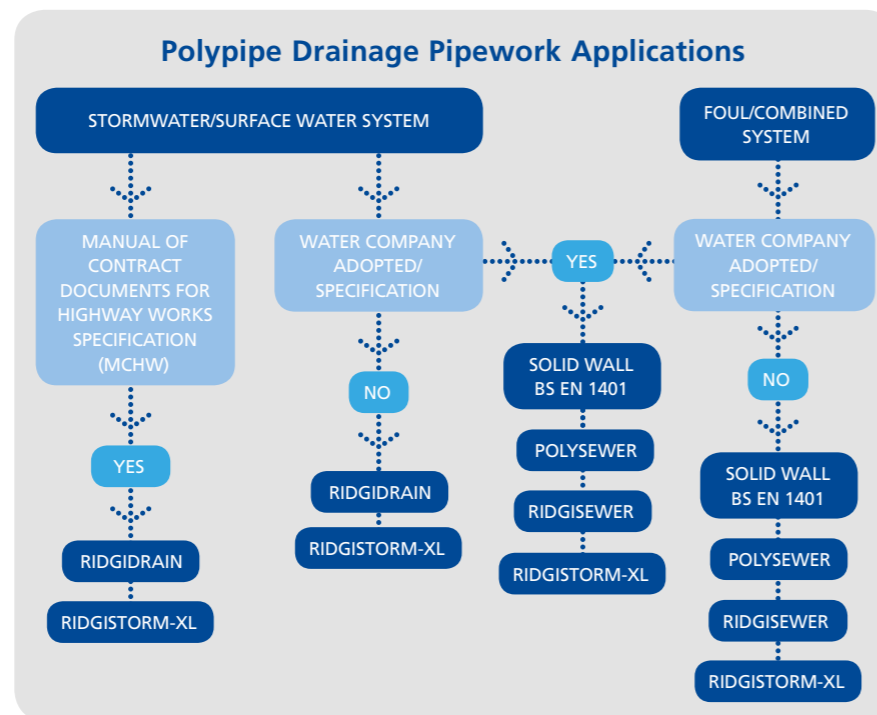

Ridgistorm-XL key benefits

- Pipe lengths available from 1.25-12m
- Integrally socketed system to aid pipe alignment
- Pre-fabricated modularised system incorporating flow controllers and treatment devices, manholes and fittings
- Lighter weight for reduced plant requirements
- Multiple jointing options include electro-fusion welding, seal jointing & extrusion welding
- Extremely durable – service lifetime expectancy of at least 100 years
- Designed to optimum stiffness classification
- Excellent load bearing capability
- Superior performance in areas of differential settlement
- Excellent resistance to sulphate and chemical attack
- Superior hydraulic performance achieved through smooth bore
- Saddles available for 150mm lateral pipe connections
- Pre-fabricated dry weather flow channels available

A versatile solution

Robust, reliable and long-lasting, Ridgistorm-XL is one of the most adaptable large diameter piping solutions in the UK. In fact, our designers can engineer exact stiffness classifications for the pipe system to meet variable loading specifications by analysing site conditions and installation parameters. This means we can deliver an effective solution that is fully adaptable.



Standards, approvals and certifications

- Water Company Approved for Capital Works projects and installation under Section 104 and Section 106 agreements*
- Compliant with MCHW, Volume 1, Series 500 (Specification for Highway Works)**
- AIP acceptance to Specification for Highway Works, Series 2500 through BD2/05 Standard for highways schemes
- Structural calculations in accordance with BS EN 1295-1, the Structural Design Standard for Buried Pipelines
- WRc approved
- Manufactured to meet the material requirements of BS EN 13476:2007 (Part 1-3), Plastic Piping Systems for Non-Pressure Underground Drainage and Sewerage
- Compliant with the requirements of the Civil Engineering Specification for the Water Industry 7th Edition (CESWI)
- Compliant with the requirements of Sewers for Adoption 7th Edition (SfA)
- Compliant with the requirements of Sewers for Scotland 3rd Edition (SfS)
- Certified to BSI ISO9001 and BSI ISO14001

*We would recommend that local water company approval is confirmed before a final design is complete. **SHW Series 500 applies to 750 and 900mm only.

Contents

| SECTION 3 | Ridgistorm-XL | |
|-----------|--------------------------------|---------|
| | Ridgistorm-XL overview | 34 - 35 |
| | Ridgistorm-XL applications | 36 - 39 |
| | Ridgistorm-XL piping system | 40 - 41 |
| | Ridgistorm-XL jointing options | 42 - 43 |
| | Ridgistorm-XL case studies | 44 - 45 |

Applications

Ridgistorm-XL is a versatile solution, proven for applications ranging from pipelines for surface water drainage and foul sewer schemes, to attenuation structures and large diameter manholes and pre-fabricated component chambers.



Waste water and sewer

Our Ridgistorm-XL pipe system offers the perfect solution for use in sewer and waste water systems. The pipes have excellent chemical resistance, are lighter in weight than concrete equivalents thereby reducing on-site Health and Safety risks, yet are strong and durable enough to withstand ground movement and differential settlement. All of our solutions are fully compliant with Sewers for Adoption, 7th Edition, CESWI and are accepted for use by all UK Water Companies for Capital Works, Section 104 and Section 106 agreements. Low Flow Channels can be incorporated within the Ridgistorm-XL pipes for improved performance. Lifting points, Safety Chain Assemblies, Guardrail Assemblies and specialist ironmongery have been developed in response to pipeline designers and contractors seeking innovation in safer, faster and more cost-effective installations.

Applications

- Sewer pipework
- Low flow systems
- Pumping stations
- Valve chambers
- Flow meter chambers
- Inter process pipework
- CSO storage

Flood alleviation

Developers are facing the challenges of having to store increasing volumes of flood water, as they look to satisfy the requirements of local authorities and Government agencies to obtain planning. Increasingly, engineered solutions are being required to satisfy these requirements. Ridgistorm-XL single pipe runs or multi-leg tanks offer flexibility in design and can form part of an engineered solution, being located under highways or POS (public open space) areas.

Applications

- On-line attenuation
- Off-line attenuation
- Infiltration tanks
- Multi-leg storage
- Low flow systems
- Stormwater run-off
- Culverts

Component chambers and manholes

Ridgistorm-XL is the ideal solution for pre-fabricated manholes or component chambers. They are modular, ready-to-install man-access solutions that integrate at any point in a drainage network system to control flow and to facilitate inspection and maintenance.

Applications

- Inlet chambers
- Oversized manholes
- Offset manholes
- Pumping stations
- Overflow storage tanks
- Weir walls
- Catchpits
- Control chambers
 - Flow controllers
 - Non-return valves
 - Penstocks
 - Flap valves
 - Gate valves

For more information about our component chambers and manholes, please see Section 4.

Applications



Infrastructure – Highways and Rail

Ridgistorm-XL has gone through extensive product evaluation to be compliant with MCHW Volume 1, Series 500 (Specification for Highway Works) (750-900mm) and AIP acceptance to Specification for Highway Works, Series 2500 through BD2/05 Standard for Highways Schemes (1050-3000mm). In addition, the pipes are lighter in weight than legacy products and have seal jointing for quicker, easier and safer installation – key considerations for infrastructure projects.

Applications

- Surface water pipelines
- Manholes
- Component chambers
- Catchpits
- UTX Chambers
- Low flow systems
- Culverts



UTX Chamber

Renewable energy

Ridgistorm-XL can be used in a variety of ways to help aid sustainable renewable energy. The system's strength, durability and versatility allows large tank structures to be created for both above and below ground applications.

Applications

- Domestic rainwater harvesting
- Commercial rainwater harvesting
- Water to air cooling storage
- Anaerobic digestion vessels
- Biomass plants



UTX Chambers are Network Rail PADS approved.
Certificate Number: PA05/05460
Approved sizes 600-1200mm

Ventilation

Ridgistorm-XL pipes are increasingly being used as a displacement ventilation system conduit. Using the pipe as either an underground or above ground ventilation system, the Biomaster anti-microbial inner lining and electro-fusion welding allows for excellent air quality.

An earth tube system allows air temperature to be preconditioned before entering the building, with the air drawn into the system via air inlets. This passive technology enables the transfer of ground source energy to heat or cool ventilation air, whilst reducing energy requirements and carbon footprints.



Applications

- Earth tubes
- Ventilation ducts
- Inter process pipework
- Valve chambers
- Baffle housings
- Service access chambers
- Flange connectors
- Landfill ventilation plenums
- Condensate chambers



Ridgistorm-XL piping system



Engineered pipe profile providing individual stiffness class

Ridgistorm-XL can be engineered to suit any application. By analysing the site conditions and installation parameters, our design engineers can create a solution with the appropriate profile strength and stiffness classifications. Our production flexibility allows pipe strength to be produced at varying stiffness classes between SN1-SN8, meaning it is never over nor under engineered, exactly meeting the design requirements of a particular project. Utilising the latest manufacturing technology and state-of-the-art software enables us to create unique profile designs to match your site requirements.

Exceptional leak tightness

Ridgistorm-XL is designed as a flexible structure to minimise the effects of ground movement, differential settlement and deformation. Exceptional structural integrity is achieved with Ridgistorm-XL due to its engineered pipe profile. It is manufactured in lengths up to 12m to reduce the number of joints, therefore minimising the number of potential leakage points and removing the risk of groundwater pollution.

Life expectancy

Ridgistorm-XL is manufactured in accordance with BS EN 13476:2007 (Part 1-3) under ISO 9001 and ISO 14001 certified management systems. A lifetime expectancy of **100+ years** can be predicted for Ridgistorm-XL using guidelines set out in BS EN ISO 9080.

For more technical information and dimensions on Ridgistorm-XL please visit our website www.polypipe.com/toolbox

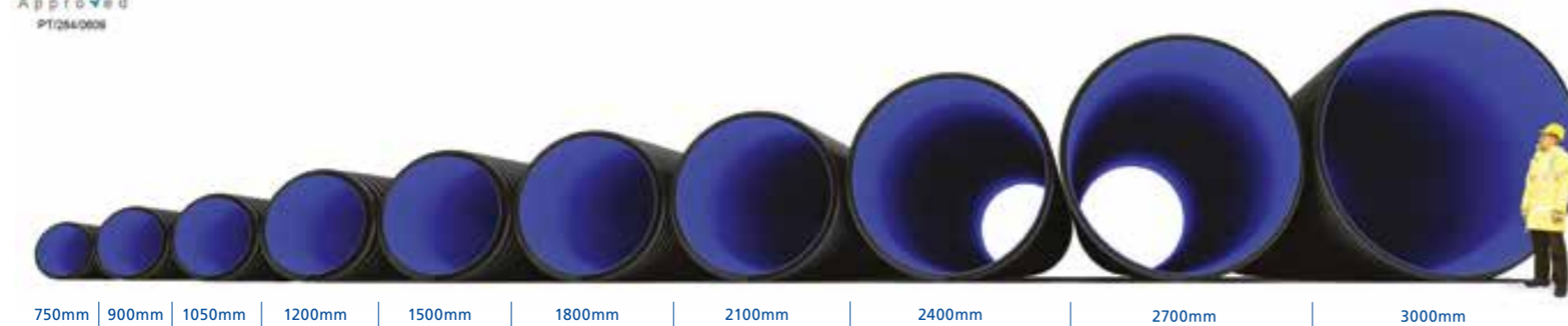

750mm | 900mm | 1050mm | 1200mm | 1500mm | 1800mm | 2100mm | 2400mm | 2700mm | 3000mm

Pipe Profiles

Pipe profile designs can be adapted to maximise strength and minimise the use of material within the pipeline. This improves pipeline performance and provides a fully engineered solution. Our range of profiles are integral to the strength and performance of the pipeline.

VW profile

Profile type VW enables the production of a solid pipe with a smooth inner and outer surface. These pipes can be produced with a wall thickness of 5-80mm. This profile is often used in pressure pipelines and certain chamber applications.

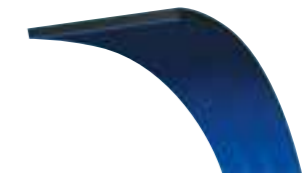

PR profile

Pipes produced with a PR profile achieve high stiffness with relatively low weight. This is a common pipe profile for use in surface water, foul and combined sewer drainage.

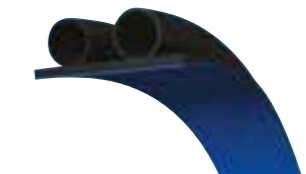

Olympia profile

In addition to the PR profile, the Olympia profile option can achieve greater pipeline stiffness with a comparatively low weight. This profile is often used in the larger diameters of Ridgistorm-XL.



SQ profile

This profile option has a smooth inner and outer surface, including internal profile to one layer. High stiffness is achieved through the SQ profile, making it ideal for extremely high loads or larger diameters.



SQ2 profile

SQ2 offers the same benefits as the single-layer SQ profile, yet it can be produced with additional profile layers for added ring stiffness.



CPR profile

The majority of our pre-fabricated components have a CPR profile achieving high stiffness with relatively low weight.

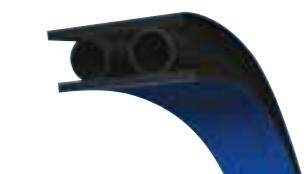

Jointing options

Ridgistorm-XL can be designed and manufactured to suit any jointing requirements on-site. Ring seals, electro-fusion welding, extrusion welding, flange connections and mechanical pipe couplings can all be utilised with the Ridgistorm-XL system, depending on the installation and application requirements of the project.



Ring seal

This is the simplest jointing method which does not require welding. Available in sizes 750-1800mm this connection uses integral socket and spigot jointing with two rubber seals, which are installed into the spigot end of the pipe or fitting. This allows pipes to be separated in the future if necessary.

This method meets the requirements of BS EN 1277. Nitrile seals are also available, typically for use where the soil contains certain chemicals. Please send soil reports to our Technical Team for further assistance.

| Ridgistorm-XL Seals | | |
|---------------------|----------|----------|
| Pipe diameter mm | Code | Pack qty |
| 750 | SRST750 | 1 |
| 900 | SRST900 | 1 |
| 1050 | SRST1050 | 1 |
| 1200 | SRST1200 | 1 |
| 1500 | SRST1500 | 1 |
| 1800 | SRST1800 | 1 |

Note: 2 seals required per joint.

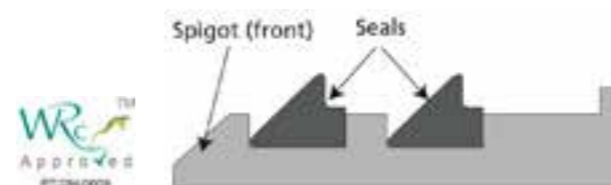

Electro-fusion welding

We offer the only large diameter plastic pipe solution with integral electro-fusion jointing. The whole pipe system effectively becomes a homogeneous unit. Electro-fusion wire is connected to the socket end of the pipe during manufacture. Available for 750-3000mm diameter pipes.

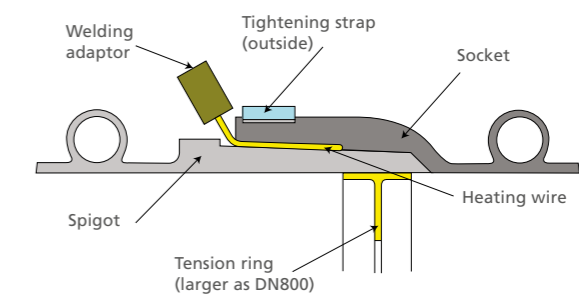

Extrusion welding

Pipes are jointed with an extrusion welding device. The jointing method can be carried out inside and/or outside the pipe. This jointing is most suitable for low-pressure gravity pipes and manholes.



Flange connection

This is a special connection, please contact our Technical Team for further details on **+44 (0) 1509 615100**. The ends of pipes and fittings are manufactured with circular flanges, jointed with the help of steel backing rings and a rubber gasket.



Mechanical pipe coupling

This is a specialist jointing method, please contact the Technical Team for further details on **+44 (0) 1509 615100**.

Mechanical pipe couplings allow pipes to be joined without the need for flanging, grooving, threading or welding.



Case studies – Gulls Way capital works scheme

– Westbrook Primary School



Pre-fabricated Ridgistorm-XL solution chosen for Welsh Water capital works scheme

The Gulls Way capital works scheme in Heswall, Wirral, required combined sewer improvements along a residential street where the existing 450mm concrete sewer had insufficient capacity to cope with high volumes of rainfall, causing the surrounding road and a number of properties to flood during storm events. Working closely with Welsh Water, consultant engineer AECOM, main contractor Costain and groundworker Mulcair Ltd from an early design stage, we supplied a fully engineered Ridgistorm-XL attenuation system comprising of a dual pipe run to provide an additional 360m³ of storage.

As well as providing Ridgistorm-XL pipes in 900mm diameters, we also utilised our large diameter piping and its ability to pre-fabricate structural components to create a number of 1500mm chambers and unique modular 'H' RIDGISTORMAccess Manholes to sit between the pipe runs. Saving time and costs whilst minimising disruption to residents in the immediate local area was vital, which is why a pre-fabricated system from Polypipe was ideal for the project.

The Ridgistorm-XL system limited the amount of work undertaken in the highway and ensured that work was able to progress much quicker than if more traditional methods had been used. We were able to deliver the chambers to site with internal benching and step runs incorporated and the light weight nature of our plastic systems – combined with Ridgistorm-XL's factory fitted lifting points – meant that the new combined sewer system was able to be installed much quicker and safer than would have otherwise been possible, minimising the project's impact on road users and local residents.



Polypipe delivers a unique earth tube project as part of the redevelopment of Westbrook Primary School

Noise pollution caused by passing aircrafts was a major problem for Westbrook Primary School, due to its location under one of the main flight paths for Heathrow Airport. The issue was exacerbated during summer months when windows needed to be opened to allow for ventilation in the building, causing disruption to learning. As part of major new construction works taking place at the school, Consulting Engineers WSP worked closely with ourselves and BSRIA to devise an innovative ventilation solution that minimised the environmental impact while limiting noise pollution.

A modular earth tube structured wall pipework system, utilising our market leading Ridgistorm-XL large diameter pipe, was installed as a ground source energy system in order to precondition the temperature of incoming air before it enters the building, with air drawn into the earth tube system via air inlets. This passive technology enables the transfer of ground source energy to heat or cool ventilation air, stabilising temperatures without compromising the learning environment. Earth tubes operate on the understanding that earth temperatures are relatively constant throughout the year at just a few metres below ground.

In the summer, the soil around the pipework will be cooler than the atmospheric air, so the pipe will deliver cool, fresh air to the school. Conversely, in winter the soil will be warmer than the atmospheric air, so the pipe will deliver warm air to the school – reducing the heating bill of the school. The system allows 100% fresh air ventilation within the school, creating an improved internal environment, while reducing the energy required to heat or cool the building and greatly reducing the school's carbon footprint in line with the requirements of the 2011 London Plan.

Case studies – Yorkshire Water

– A5 highway improvements



Yorkshire Water utilises largest diameter Ridgistorm-XL for Section 104 trial scheme

A housing development in Featherstone, West Yorkshire has benefited from our 3,000mm Ridgistorm-XL large diameter pipe, as part of a unique stormwater attenuation system. We worked closely with Yorkshire Water and RAB Engineering Design Limited to provide an innovative solution for Strata Homes' 'Origin' housing development.

With limited public open space of just 360m² available on the site, we sought to design a solution that utilised our popular Ridgistorm-XL piping solution in 3,000mm diameters to form a 430m³ stormwater attenuation system comprising four legs and two manifolds. In order to avoid overwhelming the local drainage system, the Ridgistorm-XL attenuation system discharges stormwater at a flow rate of 127 litres per second. These flow rate calculations ensure that the system will provide necessary attenuation for the development in the event of a '1 in 100' year storm event, whilst allowing additional space to mitigate the effects of climate change on rainfall, as stipulated by the local authority, which is also adoptable for Section 104 approval.

The system, designed and manufactured at our dedicated facility in Loughborough, was delivered to site for installation and jointed by internal welding by BFS Nationwide Ltd. The process was made much simpler due to the inclusion of integral sockets within Ridgistorm-XL, which work to provide improved alignment between pipes.



Vital road improvement project relies on Ridgistorm-XL

The A5 highway infrastructure improvements near Hinckley, Leicestershire, had originally specified a concrete system to provide surface water drainage for the busy highway, as part of wider improvement works. Utilising the popular Ridgistorm-XL piping system, our Technical Team engineered a solution to match the original 750mm diameter pipe specified to incorporate a single pipe run to sit beneath the road's verge, complimented by two separate twin runs, with a combined length of more than 400m.

We provided structural calculations and assisted consultant engineer Milestone by engineering a reduction in the pipe stiffness from the original specification. This was accepted for use, allowing works to commence as scheduled. With Ridgistorm-XL being up to 94% lighter in weight than alternative concrete products, it was easier to handle and reduced the need for heavy plant machinery, allowing benefits to the project including reduced time and costs of the installation.

The installation time was reduced further still as we supply Ridgistorm-XL in 6 metre lengths with ring seal joints. This limited the number of joints required and ensured that each jointing process was as quick as possible – a vital consideration within a live highway environment. The pipes were engineered to the exact strength required to meet the ground conditions and installation parameter, in this case stiffness classes 2.67kN/m², 3.056kN/m² and 6kN/m², allowing the pipe to withstand external loading during the installation process.

Fabrications overview

Our ability to provide pre-fabricated, engineered solutions offer a range of benefits that will not only ensure undertaking your project is more effective and efficient, it will also result in measurable cost savings. Our modern methods of manufacturing reduce installation time and costs on-site and also minimise Health and Safety risks during handling, storage and installation.



Fabrications key benefits

- Tailor-made, fully-welded, watertight structured wall chambers to suit project-specific requirements
- One-piece installation, off-site construction - delivered ready-to-install reducing installation time and costs
- Strong but light in weight, minimising Health and Safety risks in handling and installation
- Manufactured in a factory controlled environment for improved quality of finish
- Eliminates wastage associated with in-situ construction
- WRc approved

In-house fabrications department

Providing a unique and comprehensive service through our in-house fabrication facility, we are able to create fully engineered solutions to precisely match specific project requirements. Whether you require a one piece manhole, catchpit, flow control device or treatment filter, a customised fitting or specialist bend, our team can engineer the right system accurately and to the highest quality.

Seamless integration

Our pre-fabricated solutions are designed to integrate seamlessly within existing drainage or water management systems, including our Ridgidrain, Ridgisewer or Ridgistorm-XL systems, or can be engineered to connect to other materials.

Other fabrications are available for our drainage, sewer and cable protection ranges.

Off-site construction

We can help you to meet your project deadlines by delivering your ready-to-install, pre-fabricated system to site. Our solutions are manufactured in our factory-controlled environment, ensuring a superior finish in comparison to those constructed on-site. Additionally, the wastage usually associated with on-site construction is removed, so we are not only saving time and money, but we are also providing more environmentally friendly products and systems.

The products included over the following pages are only an example of what is possible. For full product datasheets and standard details please visit our website www.polypipe.com/toolbox, or to discuss your project with our Technical Team, please call +44 (0) 1509 615100.

Other Ridgistorm-XL fabricated solutions available include:

- Bends
- Junctions
- Reducers
- Dual run H chambers

Contents

| SECTION 2 | Fabrications | |
|-----------|--|---------|
| | Fabrications overview | 46 - 47 |
| | RIDGISTORMCheck Vortex Flow Control Chamber | 48 |
| | RIDGISTORMCheck Orifice Plate Flow Control Chamber | 49 |
| | RIDGISTORMControl Penstock and Valve Chambers | 50 |
| | RIDGISTORMAccess Manholes | 51 |
| | RIDGISTORMSeparate Silt Traps | 52 |
| | RIDGISTORMSeparate Catchpits | 53 |
| | RIDGISTORMSeparate Weir and Baffle Chamber | 54 |
| | RIDGISTORMSeparate Filter Chamber | 55 |
| | RIDGISTORM-X4 Stormwater Treatment System | 56 |
| | Ridgistorm-XL Lifting Points | 57 |
| | Ridgistorm-XL Low Flow Channel | 58 |
| | Ridgistorm-XL Chamber Accessories | 59 |



RIDGISTORMCheck Vortex Flow Control Chamber

Where flows within a drainage system are required to be limited or checked (i.e. prior to discharge from site), with improved hydraulic performance and reduced maintenance, we are able to offer our RIDGISTORMCheck Vortex Flow Control Chamber.



Pre-fabricated under factory controlled conditions, our RIDGISTORMCheck Chamber is available in a range of diameters from 1050-3000mm and incorporates a vortex flow control unit, fitted onto a preformed headwall. Each vortex flow control unit is manufactured to suit the unique hydraulic characteristics of the site's drainage system design. RIDGISTORMCheck Vortex Flow Control Chambers are typically supplied as a single unit, allowing simple installation and eliminating a number of construction risks associated with in-situ construction. When installed in conjunction with our range of pipe systems, they offer a fully integrated drainage system.

Applications

Site specific RIDGISTORMCheck Vortex Flow Control Chambers are engineered to suit a range of stormwater systems, providing a hydraulically efficient means of flow regulation that does not use moving parts or require power to operate.

Performance

RIDGISTORMCheck Vortex Flow Control Chambers are fabricated from Ridgiform-XL pipework, which is manufactured to meet the material requirements of BS EN 13476:2007 (Part 1-3).

Manual Bypass Design

The manual bypass design offers a bypass to the flow control device to facilitate maintenance. Manually operated from the surface, the activation of the bypass system opens a door in the head-wall allowing water in the chamber to drain down via the bypass pipe.

Non-Bypass Chamber

For sites where discharge rates must be guaranteed to not exceed a prescribed limit(s).

RIDGISTORMCheck Vortex Flow Control Chamber key benefits

- Self-activating vortex flow controller which controls forward flow of water
- No moving parts - virtually maintenance free
- Manufactured with an integral sump for silt catchment/removal
- Available as non-bypass or manual bypass with built in overflow
- Manufactured to adoptable standards
- Multiple inlet and outlet options, allowing quick and seamless connection to pipelines
- Depths can be tailored to suit project requirements
- Step rungs to BS EN 13101 and ladders to BS EN 14396
- Integral lifting points available on request to improve Health and Safety during handling and installation

| Element | Value |
|----------------------------|---|
| PHYSICAL PROPERTIES | |
| Diameter mm | 1050-3000 |
| Depth | To suit requirements |
| Material | HDPE |
| Colour | Black with blue interior |
| Flow control units | Grade 304 Stainless Steel |
| Chemical resistance | HDPE is naturally resistant to most chemicals associated with stormwater drainage systems |
| Inlets/outlets mm | 100-3000 |
| Hydraulic performance | Vortex flow control unit to suit site specific flow rates and head |



RIDGISTORMCheck Orifice Plate Flow Control Chamber

Where flows within a drainage system are required to be limited or checked (i.e. prior to discharge from site), in a simple and cost effective design, we are able to offer our RIDGISTORMCheck Orifice Plate Flow Control Chamber. Incorporating an integral orifice plate flow control with an optional removable Permavoid filter unit wrapped in a 2mm polyethylene mesh, to provide filtration and ease of maintenance.

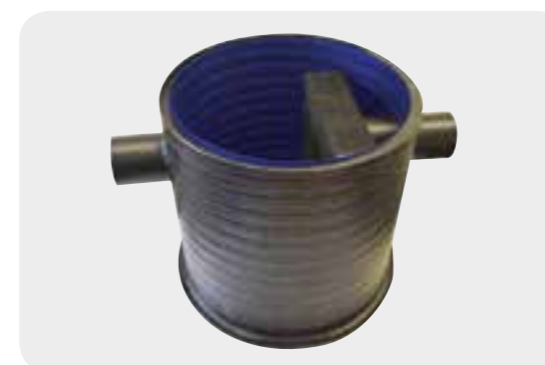

RIDGISTORMCheck Orifice Plate Flow Control Chamber offers a cost-effective means of limiting flows, particularly when used in conjunction with our range of attenuation systems on smaller scale projects.

Applications

Site specific RIDGISTORMCheck Orifice Plate Flow Control Chambers are engineered to suit a range of stormwater attenuation and infiltration systems, providing a means of flow regulation and are used regularly when designing to source control principles. The optional filter unit on the outlet provides a filtration system for reduced maintenance.

Performance

RIDGISTORMCheck Orifice Plate Flow Control Chambers are fabricated from Ridgiform-XL pipework, which is manufactured to meet the material requirements of BS EN 13476:2007 (Part 1-3).

RIDGISTORMCheck Orifice Plate Flow Control Chamber key benefits

- Manufactured with an integral sump for silt retention
- One-piece installation, off-site construction, delivered ready-to-install reducing installation time and costs
- Multiple inlet and outlet options, supplied with integral sockets as standard allowing quick and seamless connection to pipeline
- Depths can be tailored to suit project requirements
- Step rungs to BS EN 13101 and ladders to BS EN 14396
- Integral lifting points available on request to improve Health and Safety of handling and installation

| Element | Value |
|----------------------------|---|
| PHYSICAL PROPERTIES | |
| Diameter mm | 500-3000 |
| Depth | To suit requirements |
| Material | HDPE |
| Colour | Black with blue interior |
| Chemical resistance | HDPE is naturally resistant to most chemicals associated with stormwater drainage systems |
| Inlets/outlets mm | 100-3000 |
| Hydraulic performance | Orifice plate flow controls to suit site specific flow rates and head |

For the full datasheets and standard details, for both of the RIDGISTORMCheck Chambers, please visit our website www.polypipe.com/toolbox



RIDGISTORMControl Penstock and Valve Chambers

Where a drainage or sewer system design requires the inclusion of control devices to limit or isolate flows, our range of RIDGISTORMControl Chambers are available with pre-installed Penstocks, Flap Valves and Gate Valves.



Flap Valve



Penstock

RIDGISTORMControl Chambers are typically supplied as single units, manufactured in factory controlled conditions to improve the quality of finish and eliminate wastage associated with in-situ construction.

Applications

Our pre-fabricated RIDGISTORMControl Chambers incorporate a range of flow control devices to limit or isolate flows within surface water, sewer and combined sewer systems.

Typical valves include:

Gate Valves

Gate Valves are used to permit or prevent the flow of water and can isolate drainage sections. The valve opens by lifting a wedge out of the path of the flow of water.

Flap Valves

Flap Valves are non-return hinge valves to prevent backflow upstream. They can also be used for outflow applications such as ponds, ditches, swales and tidal.

Penstocks

Penstocks consist of a gate which can isolate or control water flow. The gate can also be used as a flow control device to limit the flow of water passing through the system.

Performance

RIDGISTORMControl Penstock and Valve Chambers are fabricated from Ridgidrain-XL pipework, which is manufactured to meet the material requirements of BS EN 13476:2007 (Part 1-3).

RIDGISTORMControl Penstock and Valve Chamber key benefits

- Facilitates maintenance, controls system flows and protects the drainage system from surcharging
- System components available include: Penstocks, Gate Valves and Flap Valves
- Multiple inlet and outlet options, supplied with integral sockets as standard allowing quick and seamless connection to pipeline
- Chamber depths are tailored to suit project requirements
- Lockable steel covers available
- Integral benching
- Step rungs to BS EN 13101 and ladders to BS EN 14396
- Optional riser section
- Integral lifting points available on request to improve Health and Safety of handling and installation

| Element | Value |
|----------------------------|---|
| PHYSICAL PROPERTIES | |
| Diameter mm | 1200-3000 |
| Depth | To suit requirements |
| Material | HDPE |
| Colour | Black with blue interior |
| Loading | Determined by structural design |
| Chemical resistance | HDPE is naturally resistant to most chemicals associated with stormwater drainage systems |
| Inlets/outlets mm | 100-3000 |



RIDGISTORMAccess Manholes

Whether your project calls for stormwater, foul water or combined sewer systems, we can manufacture high density polyethylene (HDPE) pre-fabricated manholes, to provide easy access into and maintenance of a pipeline. RIDGISTORMAccess Manholes are utilised where pipe runs change direction, combine, change invert level, diameter or pipe material.

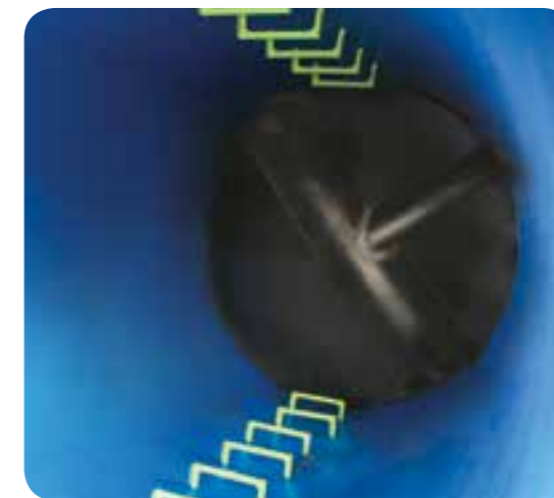

RIDGISTORMAccess Manholes key benefits

- Provides easy access for maintenance
- Manufactured to adoptable standards
- Full range of accessories available including Safety Chain Assembly and Guardrail Assembly
- Multiple inlet and outlet options, supplied with integral sockets as standard allowing quick and seamless connection to pipeline
- Depths can be tailored to suit project requirements
- Factory installed, high quality integral benching
- Step rungs to BS EN 13101 and ladders to BS EN 14396
- Optional riser section
- Riser location ring
- Integral lifting points available on request to improve Health and Safety of handling and installation

Applications

RIDGISTORMAccess Manholes are engineered for use in stormwater, foul and combined sewer applications to enable access to the pipework system for inspection and maintenance. Factory installed, preformed benching and channelling is available to spring line (SHW) or soffit (SFA) depending on the specification required. RIDGISTORMAccess Manholes can be pre-fabricated with a number of features to reduce the need for direct access into the pipe, such as an offset channel, or maximising step landing width, or to minimise operational Health and Safety risks with the pre-fabrication of Safety Chain Assembly and Guardrail Assembly, please see page 59 for further information.

Compatibility

RIDGISTORMAccess Manholes can be integrated into our surface water (Ridgidrain and Ridgistorm-XL) and sewer (Polysewer, Ridgisewer and Ridgistorm-XL) pipework systems, or engineered to connect to other pipe materials.

Performance

RIDGISTORMAccess Manholes are fabricated from Ridgidrain-XL pipework, which is manufactured to meet the material requirements of BS EN 13476:2007 (Part 1-3).

| Element | Value |
|----------------------------|---|
| PHYSICAL PROPERTIES | |
| Diameter mm | 900-3000 |
| Depth | To suit requirements |
| Material | HDPE |
| Colour | Black with blue interior |
| Loading | Determined by structural design |
| Chemical resistance | HDPE is naturally resistant to most chemicals naturally found in stormwater run-off and uncontaminated ground |
| Inlets/outlets mm | 100-3000 |



RIDGISTORM Separate Silt Traps

Located upstream of retention, attenuation and infiltration drainage systems, RIDGISTORM Separate Silt Traps capture and retain silt and separate out other particles by encouraging settlement in the unit sump, preventing ingress into sustainable drainage systems (SuDS). This range of small diameter silt traps are standard stock items and are readily available.



Mini silt trap
Product code: PSMST110



Advanced silt trap
Product code: PSMST160/15

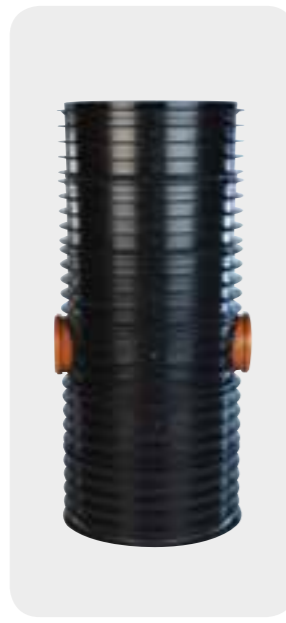

Basic silt trap
Product code: PSMST160

RIDGISTORM Separate Silt Traps key benefits

- Improves water quality by removing silt, grit and litter, protecting downstream elements of the drainage systems
- Self cleansing
- Prevents the ingress of debris, silt and litter into the structure
- Multiple inlet and outlet options, supplied with integral sockets as standard allowing quick and seamless connection to pipeline
- Plastic or lockable steel covers available from Polypipe Building Products

Applications

For use in stormwater drainage systems typically located upstream of retention, attenuation and infiltration drainage elements to protect the ingress of silt and other particles.

| SILT TRAP ASSOCIATED PRODUCTS | | |
|--|--|-------|
| PRODUCT | DESCRIPTION | CODE |
| PVC 320mm cover & frame (round) | 320mm sealed screw down cover & frame, includes seals and fixing screws | UG501 |
| PVC 320mm cover & frame (square) | 320mm square plastic cover with PP frame, includes seals and fixing screws | UG502 |
| 460mm silt trap cover & frame (round) | Round cover complete with seals and fixing screws (35kN test load) | UG511 |
| 450mm silt trap cover & frame (square) | Square PP cover complete with seals and fixing screws (35kN test load) | UG512 |
| Polypropylene cover & frame | Reduced access square PP cover and frame with seals and fixing screws (35kN test load) | ICDC1 |
| Chamber riser section | Silt trap side riser (215mm effective height) | ICDR1 |
| Silt trap sealing ring | EPDM 110mm seal | UG488 |

Note: Polypropylene (PP)

| PHYSICAL PROPERTIES | MINI | BASIC | ADVANCED |
|---------------------|--|--|--|
| Nominal diameter mm | 320 | 460 | 460 |
| Depth mm | 440 | 1220 | 830 |
| Inlet and Outlet mm | 110 (BS EN 1401-1) | 160 (BS EN 1401-1) | 160 (BS EN 1401-1) |
| Sump depth mm | 250 | 420 | 280 |
| Material | Polypropylene | Polypropylene | Polypropylene |
| Colour | Black chamber | Black chamber | Black chamber |
| Chemical resistance | Polypropylene is resistant to the most chemicals associated with stormwater drainage systems | Polypropylene is resistant to the most chemicals associated with stormwater drainage systems | Polypropylene is resistant to the most chemicals associated with stormwater drainage systems |

Note: For a Basic Silt Trap risers and seals are required. The bucket and filter are easily removable from the Advanced Silt Trap to enable cleaning.

RIDGISTORM Separate Catchpits

Our purpose-built large diameter high density polyethylene (HDPE) pre-fabricated catchpits are ideal for stormwater and land drainage applications and are the simplest and most cost-effective way of separating out silt and debris, providing an easily maintainable drainage system.



RIDGISTORM Separate Catchpits are designed to separate silt and other particles from stormwater, helping to protect the downstream drainage system and local environment. They can be integrated into our range of pipe systems, such as Ridgidrain and Ridgistorm-XL, to offer a fully integrated drainage system.

Applications

RIDGISTORM Separate Catchpits are pre-fabricated for use in a range of stormwater systems requiring silt and debris separation and retention.

Performance

RIDGISTORM Separate Catchpits are fabricated from Ridgistorm-XL pipework, which is manufactured to meet the material requirements of BS EN 13476:2007 (Part 1-3).



For the full RIDGISTORM Separate datasheets and standard details, please visit our website www.polypipe.com/toolbox

RIDGISTORM Separate Catchpits key benefits

- Provides easy access for silt collection
- Network Rail Parts and Drawing System (PADS) approved for use in cess areas
- Separates silt and debris from the downstream drainage system
- Fully-welded, watertight structured wall chambers to suit project-specific requirements
- One-piece installation, off-site construction, delivered ready-to-install reducing installation time and costs
- Multiple inlet and outlet options, supplied with integral sockets as standard allowing quick and seamless connection to pipeline
- Depths can be tailored to suit project requirements
- Step rungs to BS EN 13101 and ladders to BS EN 14396
- Integral lifting points available on request to improve Health and Safety of handling and installation

| Element | Value |
|----------------------------|---|
| PHYSICAL PROPERTIES | |
| Diameter mm | 450–3000 |
| Depth | To suit requirements |
| Sump depth | To suit (min. 50mm) |
| Material | HDPE |
| Colour | Black with blue interior |
| Chemical resistance | HDPE is naturally resistant to most chemicals associated with stormwater drainage systems |
| Inlets/outlets mm | 100-3000 |

RIDGISTORMSeparate Weir and Baffle Chamber

RIDGISTORMSeparate Weir and Baffle Chambers can be installed within new installations or retrofit into existing drainage systems. They are designed to provide basic silt and oil separation, retaining these pollutants in the drainage system and protecting downstream systems.



RIDGISTORMSeparate Weir and Baffle Chambers can be integrated into our range of pipe systems, such as Ridgidrain and Ridgistorm-XL, or even engineered to connect to other materials to offer a fully integrated drainage system.

Applications

RIDGISTORMSeparate Weir and Baffle Chambers are pre-fabricated for use in a range of stormwater attenuation and infiltration systems requiring 'in-line' silt and oil separation.

| Element | Value |
|----------------------------|---|
| PHYSICAL PROPERTIES | |
| Diameter mm | 900-3000 |
| Depth | To suit requirements |
| Sump depth | To suit (min. 50mm) |
| Material | HDPE |
| Colour | Black with blue interior |
| Chemical resistance | HDPE is naturally resistant to most chemicals associated with stormwater drainage systems |
| Inlets/outlets mm | 100-3000 |

RIDGISTORMSeparate Weir and Baffle Chamber key benefits

- Separates silt and oil to protect the downstream drainage network
- Tailor-made, fully-welded, watertight pre-fabricated chambers to suit project-specific requirements
- One-piece installation, off-site construction - delivered ready-to-install reducing installation time and costs
- Multiple inlet and outlet options allowing quick and seamless connection to pipelines
- Depths can be tailored to suit project requirements
- Step rungs to BS EN 13101 and ladders to BS EN 14396
- Integral lifting points



For the full RIDGISTORMSeparate datasheets and standard details, please visit our website www.polypipe.com/toolbox

RIDGISTORMSeparate Filter Chamber

RIDGISTORMSeparate Filter Chambers incorporate both a sump and removable filter unit on the chamber outlet to capture silt and debris. The filter unit is easily removed for maintenance purposes and can also be incorporated into Catchpits and Weir and Baffle Chambers.

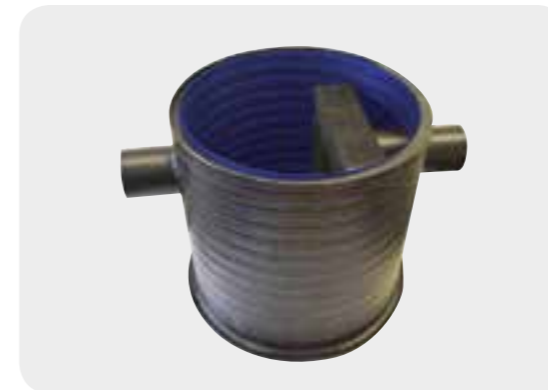

RIDGISTORMSeparate Filter Chambers can be integrated into our range of pipe systems, such as Ridgidrain and Ridgistorm-XL, to offer a fully integrated drainage system.

Applications

RIDGISTORMSeparate Filter Chambers are pre-fabricated for use in a range of stormwater systems requiring silt and debris separation.

Performance

RIDGISTORMSeparate Filter Chambers are fabricated from Ridgistorm-XL pipework, which is manufactured to meet the material requirements of BS EN 13476:2007 (Part 1-3).



RIDGISTORMSeparate Filter Chamber key benefits

- Easily accessible removable filter
- Washable filter unit
- Multiple inlet and outlet options, supplied with integral sockets as standard allowing quick and seamless connection to pipeline
- Depths can be tailored to suit project requirements
- Step rungs to BS EN 13101 and ladders to BS EN 14396
- Integral lifting points available on request to improve Health and Safety of handling and installation

| Element | Value |
|----------------------------|---|
| PHYSICAL PROPERTIES | |
| Diameter mm | 500-3000 |
| Depth | To suit requirements |
| Sump depth | To suit (min. 50mm) |
| Material | HDPE |
| Colour | Black with blue interior |
| Chemical resistance | HDPE is naturally resistant to most chemicals associated with stormwater drainage systems |
| Inlets/outlets mm | 100-3000 |

RIDGISTORM-X4 Stormwater Treatment System

RIDGISTORM-X4 is a 4-stage treatment device, used for the treatment of surface water run-off, providing high levels of contaminant removal, including hydrocarbons and heavy metals. Utilising a number of processes the RIDGISTORM-X4 Stormwater Treatment System consistently provides proven levels of protection for the downstream elements of the drainage system and local environment.

1. Sedimentation

Water is induced into a radial flow within the dynamic separator at the base of the unit, promoting sedimentation of solid particles.

2. Filtration

Water flows up from the separator and through removable filter elements. The filter elements remain saturated, minimising the risk of the filter elements clogging.

3. Chemical Separation

While passing through the filter unit, dissolved chemical pollutants are removed through a process of adsorption, absorption and precipitation.

4. Oil Retention

Water is finally discharged via an oil trap assembly which is designed to retain free floating oils in the event of a major spill.

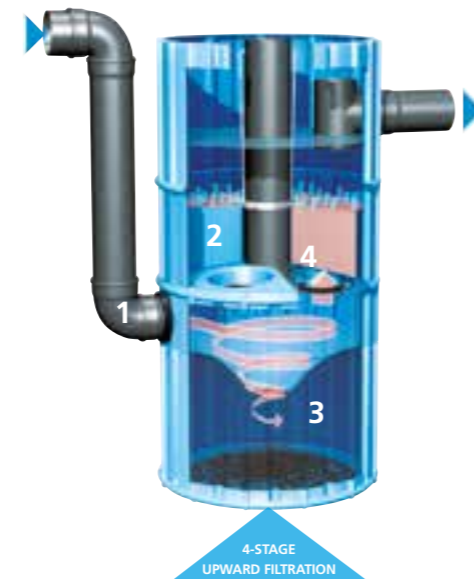

Applications

RIDGISTORM-X4 is capable of cleaning surface water run-off from roofs, car parks, roads and heavily trafficked areas. The RIDGISTORM-X4 Stormwater Treatment System is a low maintenance solution for all surface water applications.

Performance

RIDGISTORM-X4 Stormwater Treatment Systems are fabricated from Ridgistorm-XL pipework, which is manufactured to meet the material requirements of BS EN 13476:2007 (Part 1-3).

Filters have no moving parts and have an average expected lifespan of 2 years (based on nominal usage).

| RIDGISTORM-X4 | | | |
|--|-----------------------------|-----------------------|--------------------|
| PHYSICAL PROPERTIES | RIDGISTORM-X4 HEAVY TRAFFIC | RIDGISTORM-X4 TRAFFIC | RIDGISTORM-X4 ROOF |
| Height mm | 1985 | 1985 | 1985 |
| Diameter mm* | 980 | 980 | 980 |
| Chamber material** | PE | PE | PE |
| Weight kg* | 122 | 122 | 122 |
| Recommended max. catchment area m ² | 500 | 750 | 1000 |
| Number of Filter elements | 4 | 4 | 4 |
| Weight/element kg | 54 | 34 | 34 |
| Connections mm | 200 | 200 | 200 |

*Unit typically supplied within a pre-fabricated chamber. However these measurements may increase dependant on the proposed unit's general arrangements. **Majority of components are polyethylene (PE), however other materials are used in the unit manufacture.

RIDGISTORM-X4 key benefits

- Advanced 4-stage filtration system
- Treats water from roofs, car parks and roads
- Separates and removes silt, heavy particles, oil, phosphorus and heavy metal pollutants
- Low maintenance – no moving parts
- Facilitates compliance with Water Framework Directive
- Supplied within a pre-fabricated chamber delivered to site ready-to-install or as a stand alone unit
- Step rungs to BS EN 13101 and ladders to BS EN 14396
- Integral lifting points available on request to improve Health and Safety of handling and installation
- Chamber is strong but light in weight, minimising Health and Safety risks

For further information please see the full RIDGISTORM-X4 datasheet available on our website www.polypipe.com/toolbox

Ridgistorm-XL Lifting Points

The range of Ridgistorm-XL Lifting Points have been designed specifically to aid in the safe handling of Ridgistorm-XL chambers when loading, off-loading and installing the products on-site. The lifting points consist of three plastic lugs, which are pre-welded into a Ridgistorm-XL chamber by our in-house Fabrication Team. These lugs provide external points for the attachment of lifting accessories and can lift up to 2500kg in weight.

| RIDGISTORM-XL LIFTING POINTS | | | |
|------------------------------|-------------------------|-------------------------|---------------------------|
| PHYSICAL PROPERTIES | STANDARD LIFTING POINTS | EXTENDED LIFTING POINTS | HEAVY DUTY LIFTING POINTS |
| Product code | RSTLP | RSTELP | RSTHLP |
| Pipe diameter mm | 1050-1800 | 2100-3000 | 2100-3000 |
| Safe working load kg | 1500 | 1500 | 2500 |

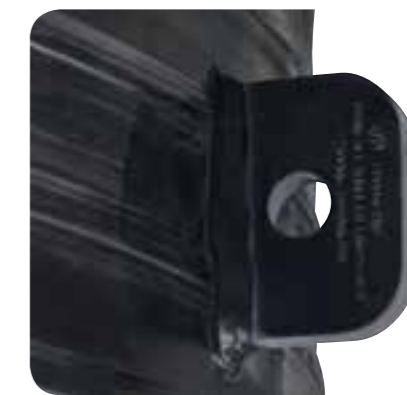

- For any asymmetrical chambers, additional slings or other suitable lifting equipment will be needed to prevent the chamber swinging during the lift
- The designated competent person* must have read and understood our Ridgistorm-XL Chamber Lifting Instruction and Guidance document before commencing with any lift of this product
- All packaging should be removed from the product prior to any lift being carried out
- The lifting of this product must only be conducted utilising all three or more lifting points, with additional slings or other lifting devices where deemed necessary

Important

*All chamber lifts should be carried out by a 'competent person' under a site specific risk assessment and lifting plan, adhering to the 'lifting instructions' carried out in our Ridgistorm-XL Chamber Lifting and Guidance document.

Note: Polypipe are not liable for any lift carried out by a third party.

Lifting points key benefits

- Installed off-site to ensure leak tightness
- 3 lifting points per chamber provide stability during handling
- Fail-safe design
- Lifting points are external to the chambers to reduce the Health and Safety risks of working in confined spaces
- Can be used as anti-flotation devices to stop the chamber floating during concrete filling
- The lugs can be removed after installation without compromising the leak tightness of the chamber

For full details on Ridgistorm-XL lifting points, please see our Ridgistorm-XL Chamber Lifting Instruction and Guidance document which can be downloaded from our website toolbox www.polypipe.com/toolbox

Ridgistorm-XL Low Flow Channel

Our Ridgistorm-XL Low Flow Channel (LFC) is ideally suited to large capacity surface water, foul and combined sewers where a minimum self-cleansing velocity is required for dry weather flows. It is available with a ring seal joint from 900-1800mm and with an electro-fusion joint from 900-3000mm. 150mm, 225mm and 300mm channels are available as standard to suit project specifications. Other sizes are available, please contact our Technical Team for further information.

Low Flow Channel key benefits

- Prevents water stagnation, reduced siltation and stouling debris and eliminates blockages
- Can be used for Ridgistorm-XL pipes from 900-3000mm
- 150mm, 225mm and 300mm channels as standard
- Can be used for both sealed and electro-fusion jointed pipes
- Chemical resistant
- Ability to withstand ground movements and to move with the pipe without failure of welds and fixing points
- Puncture resistant



For more information please see our Ridgistorm-XL Low Flow Channel installation guide, which can be downloaded from our website www.polypipe.com/toolbox

Joining accessories

During installation, it is necessary to use a suitable 'Ridgistorm-XL LFC Alignment Jig' to suit the channel width, to ensure a continuous linear low flow channel.



| LFC ALIGNMENT JIG | |
|-------------------|--------------|
| CHANNEL WIDTH mm | PRODUCT CODE |
| 150 | RST150LFCJAT |
| 225 | RST225LFCJAT |
| 300 | RST300LFCJAT |

Ridgistorm-XL Chamber Accessories

Guardrail Assembly Product code: RSTGR



Ridgistorm-XL Guardrail Assemblies can be pre-installed into our manholes and chambers, with an outflow pipe greater than 600mm, to act as a safety barrier. The Guardrail Assembly consists of three components:

- Guardrail attachment points
- Pre-assembled Guardrail
- Chain gates

Guardrail Assembly key benefits

- Compliant with Sewers for Adoption, 7th Edition and MCHW F Series
- Prevents the site workers from accidentally falling into the outflow channel
- Pre-fabricated into the chamber, delivered to site as a one-piece modular unit ready to install

Safety Chain Assembly Product code: RSTSC



Ridgistorm-XL Safety Chain Assemblies are securely fixed into RIDGISTORMAccess Manhole outflow pipes greater than 600mm, acting as a lifeline if a worker was to accidentally fall into the outflow pipe whilst in the manhole or chamber. The Safety Chain Assembly is positioned as close to the end of the channel as possible, allowing the worker to hold onto the chain to prevent being carried further into the system.

Safety Chain Assembly key benefits

- Compliant with Sewers for Adoption, 7th Edition and MCHW F Series
- Secured across the outflow pipe
- Prevent the site worker from being swept down the outflow pipe whilst in the manhole
- 3kN breaking strength
- Pre-fabricated into the chamber, delivered to site as a one-piece modular unit ready to install

Ladders & Steps



Access to Ridgistorm-XL chambers and manholes can be aided by incorporating either step rungs or ladders.

Ladders & Steps key benefits

- Ladders to BS EN 14396
- Step rungs to BS EN 13101
- Pre-fabricated into the chamber, delivered to site as a one-piece modular unit ready to install

Geocellular solutions overview

We have the largest range of geocellular products and systems in the market, allowing you to select the optimum solution for surface water management and pollution control. With a choice of products for shallow or deep excavations, our Permavoid and Polystorm systems can match your exact site specifications and loading conditions.



Contents

| SECTION 5 | Geocellular solutions | |
|-----------|---|---------|
| | Geocellular solutions overview | 60 - 61 |
| | The Permavoid system | 62 - 63 |
| | Permavoid applications | 64 - 65 |
| | Permavoid system components | 66 - 69 |
| | Permavoid 85 & 150 | 70 |
| | Permachannel | 71 |
| | Permavoid Biomat | 72 |
| | Permafilter Geotextile | 73 |
| | Polystorm range | 74 - 75 |
| | An 8 step guide to the Polystorm system | 76 - 79 |
| | Polystorm Lite | 80 |
| | Polystorm-R | 81 |
| | Polystorm | 82 |
| | Polystorm Xtra | 83 |
| | Polystorm Access | 84 |
| | Polystorm Inspect | 85 |
| | Permavoid case studies | 86 - 87 |
| | Polystorm case studies | 88 - 89 |



Permavoid for shallow applications

Permavoid is a geocellular sub-base replacement system, which has been specifically designed and tested to provide stormwater treatment, retention, attenuation or infiltration at shallower depths.

For further information, [see page 62](#).

Polystorm for deep applications

The tried and tested Polystorm range is designed to provide retention, attenuation or infiltration at a variety of depths. It is ideally suited for deeper applications and can accommodate a wide range of traffic loadings, from pedestrianised to large HGV parks.

For further information, [see page 74](#).

The Permavoid system

Permavoid is an engineered, geocellular water management system that meets the demands of current legislation and guidance for source control and surface water treatment. The system comprises of high-strength recycled polypropylene modular cells, connected together using tapered ties to create a consistent structural raft of exceptional high compressive and tensile strength, ideal for sub-base replacement.

Why a shallower application?

Shallower attenuation or infiltration structures are often necessary because the ground at greater depths presents a construction challenge, of one kind or another. This could be due to the presence of chemicals or contamination left over from previous land use, a high water table or hard rock areas. Some drainage engineers prefer a shallower approach because it does not rely on expensive pumping equipment. Shallower methods also reduce environmental impact because they require less excavation and fewer trips to transport infill and rubble to and from the site. They are also much more versatile and cost-effective than deeper solutions, as no trench supports are required and the need for expensive, heavy plant usually required during installation, is eliminated.

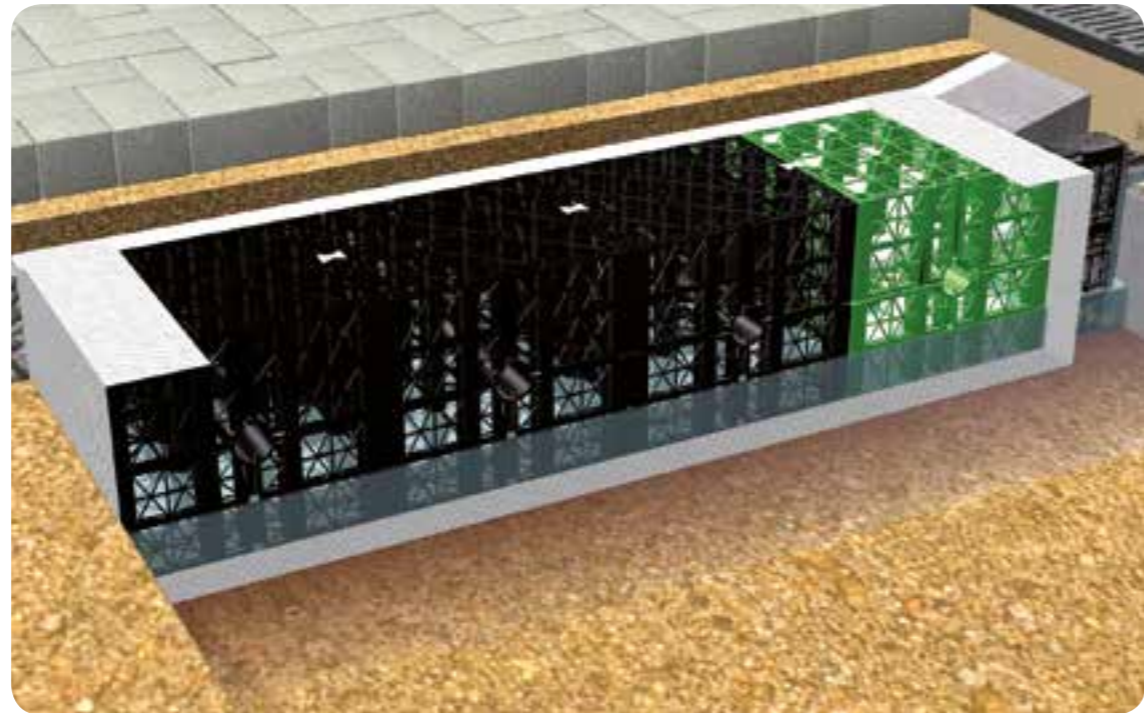

- ### The Permavoid system key benefits
- Designed and tested for retention, attenuation or infiltration at shallower depths
 - Provides effective source control
 - Can be installed above a high water table
 - Allows water to be spread across a wide area
 - Ideal for brownfield or contaminated sites
 - Provides treatment to remove silt and hydrocarbon deposits
 - Removes the requirement for pumping stations
 - Oil interception at source – no need for petrol interceptors
 - Can be used in combination with the full range of Polystorm geocellular solutions for deeper applications
 - Interlocking raft for rigidity and a high compressive and tensile strength under load
 - Suitable for use beneath porous and non-porous surfaces
 - Reduction in excavation depth and cost
 - No need for trench supports or plant to deliver and remove trench support panels
 - Can be used in conjunction with soft SuDS to help 'make space for water'

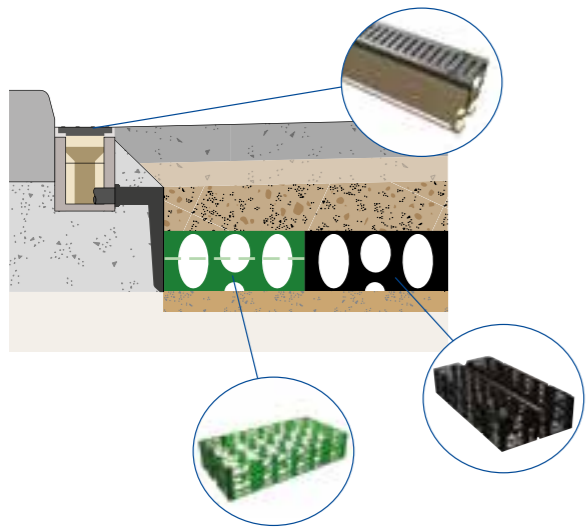

Within impervious pavements

Within impervious pavements, Permavoid can be installed as a replacement for granular sub-base to enhance the attenuation capacity, due to the high void ratio of the Permavoid modular cell. Permachannel and Permaceptors are used to capture water from hardstanding areas. They treat surface water run-off and transfer the flow into the adjoining Permavoid layer.

The water treatment efficiency of the system is enhanced with the addition of Permavoid Biomats. These have a floating oil treatment geotextile which prevents any excess oils and hydrocarbons entering the storage system.



Within pervious pavements

As Permavoid can be installed as a replacement for granular sub-base; the attenuation capacity of pervious pavements can be significantly increased due to the high void ratio of the Permavoid modular cell and the thickness of traditional granular layers may be reduced in many instances. The water treatment efficiency of the pavement can also be significantly enhanced by the introduction of Permafilter oil treatment geotextile at formation level to prevent any excess oils and hydrocarbons from passing through the storage system. This is also relevant where pavements are designed as infiltration features.

Permavoid applications

With an increasing emphasis being placed on the implementation of source control drainage solutions, the Permavoid system provides a flexible, modular geocellular water management solution for a wide range of applications.



Suitable for almost every project

The Permavoid system can be incorporated into the full range of traffic conditions, from domestic driveways to HGV applications and is suitable below pervious and impervious asphaltic, block paved or concrete paved areas. The Permavoid system complies with the requirements of BS 7533-13 and incorporates a high vertical compressive strength of 715 kN/m² and lateral compressive strength of 156 kN/m².

High water tables

High water tables and even perched water at shallow depths, require specific design and construction measures to avoid issues such as flotation of attenuation structures, and often prevents the use of soakaways. Anti-flotation and temporary dewatering measures are invariably very expensive. The Permavoid system can often provide the attenuation or infiltration solution for such projects by avoiding groundwater issues.

Contaminated land

Redevelopment of brownfield sites is commonplace and issues of ground contamination often go together simultaneously. Permavoid structures can negate the need to excavate into contaminated soils, a process that would otherwise incur significant costs in on-site remediation or off-site disposal, as well as associated environmental issues.

Excavation of hard rock

Excavation of hard rock is usually expensive and slow. However, Permavoid is ideal for use on sites that are underlain by hard rock at shallow depth as the systems can be incorporated into the pavement construction. This invariably avoids any net additional excavation for the drainage system.

Shallow outfalls

Shallow Permavoid solutions can very often avoid the need for pumping that might otherwise be required with conventional drainage or deep attention tank solutions. Pumped solutions can be costly to install and maintain and are considered to be environmentally unsustainable.

Limited access sites

The Permavoid system can be easily man-handled into place without any heavy lifting or off-load equipment. The footprint of the structure does not have to be square; segmented tanks can fit into the available space.

Ground stabilisation

Due to their high compressive strength and bending resistance within the joints, Permavoid cells create a horizontal, consistent structural raft providing a stable structure.

Soft landscaped areas

The Permavoid system can be used to provide pre-treatment of stormwater run-off before it enters a swale, dry basin, pond or wetland. It can even be installed below soft SuDS to improve treatment and increase storage capacity.

Multi-function and urban landscapes

SuDS is an integral function of water sensitive urban designs (WSUD). Permavoid offers an efficient storage and treatment system to help achieve improved stormwater management, particularly when incorporated into urban retrofitting applications.

Bio-retention systems

The Permavoid system can be an effective storage and treatment solution when incorporated into the design of rain gardens and bioretention systems where space is limited.

Public open spaces

Acting as both a sub-base replacement system and drainage component, the Permavoid system can give maximum attenuation and infiltration capabilities for both natural and artificial surfaces and be integrated into site-wide sustainable drainage systems more effectively. The result is a sustainable development in line with the DEFRA national standards for delivery of sustainable drainage systems.

Driveways

Any domestic driveway or front garden over 5m² that is being paved must incorporate SuDS to minimise the risk of flooding. The Permavoid system, used in conjunction with permeable paving, can help adhere to these requirements whilst allowing a wide range of landscaping options.

Permavoid system components

The Permavoid system comprises of:

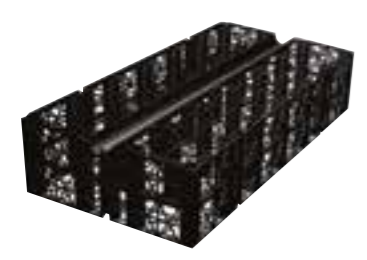

Permavoid (85 & 150)
 Product codes: PVPP85 & PVPP150
 Geocellular sub-base replacement system that locks together to form an interlocking raft of exceptional high compressive and tensile strength.

See page 70



Permachannel
 Product code: PV03001
 A linear treatment system that combines run-off collection, silt and effluent interception and water treatment functions.

See page 71



Permavoid Biomat
 Product code: PV150BM
 High strength geocellular unit containing a low density, oil treating, geosynthetic floating mat.

See page 72



Permafilter Geotextile
 Product code: PV23002
 A non-woven, dimpled, needle-punched geotextile designed for hydrocarbon pollution treatment.

See page 73



Geomembrane
 An impermeable membrane for wrapping around Permavoid structures to form watertight tanks.



Permaties
 Product code: PVCLIP
 Fully interlocking tapered tie connections to securely link Permavoid cells together horizontally in a single structure and to transfer tensile loads.

Our technical manual and datasheets for the Permavoid system components can be found on our website www.polypipe.com/toolbox



Shear Connector
 Product code: PVSC
 Securely links multiple layers of Permavoid together in a single structure.



Permavoid Medium Duty with Biomat
 Product code: PSM1BM
 Comprising of a low density, oil treating geosynthetic floating mat for use with the Polystorm range of modular geocellular units.



Permaceptor
 Product code: PV04002
 A combined run-off collection, silt/oil interceptor and treatment system used with road/yard gullies.



Permafoam (85 & 150)
 Product codes: PVPP85PF & PVPP150PF
 An open celled absorbent phenolic foam incorporated into Permavoid geocellular units for 'on demand' irrigation or check dams.



Permatex 300
 Product code: PV23006
 A heavy duty, non-woven, polypropylene, geotextile designed to protect and separate Permavoid geocellular layers.



Orifice Plate Flow Control Chambers
 A pre-fabricated orifice plate flow control unit, incorporating a removable filter to protect the orifice.



Permavoid Rainwater Diffuser Unit
 Product code: PV09011
 Permavoid units encapsulated with a 2mm mesh fabric diffuse the collected run-off into the surrounding granular sub-base.



Permavoid Connectors
 A range of Spigot and Saddle Connectors allowing piped connection to the Permavoid structure.



Permavoid Capillary Geotextile
 Product code: PV23008
 A heavy duty, non-woven geotextile formulated to provide passive irrigation to soft and landscaped areas.

SECTION 5 Geocellular solutions

www.polypipe.com/geocellarsolutions

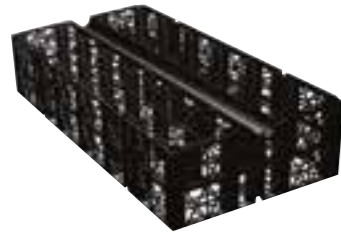

Permavoid 150 cell

| Permavoid Modular Cells | | |
|------------------------------------|------------------|-----------|
| Description | Dimensions mm | Code |
| Permavoid 85 | 708 x 354 x 85 | PVPP85 |
| Permavoid 150 | 708 x 354 x 150 | PVPP150 |
| Permavoid Biomat | 708 x 354 x 150 | PV150BM |
| Permafoam 85 | 708 x 354 x 85 | PVPP85PF |
| Permafoam 150 | 708 x 354 x 150 | PVPP150PF |
| Permavoid 85 Capillary Cone | 708 x 354 x 85 | PVPP85CC |
| Permavoid Medium Duty with Biomat* | 500 x 400 x 1000 | PSM1BM |

*Please use Polystorm Shear Connectors and Clips.

| Sumps, Catchpits and Orifice Plate Flow Control Chambers | | |
|---|--|---------|
| Description | Dimensions | Code |
| 315mm Rainwater Downpipe Filter Chamber with litter guard | Maximum 0.5m deep, 110mm inlet, 160mm outlet | PV05007 |
| 500mm Silt Pit Chamber | Maximum 1m deep, 300mm deep sump, 4x Spigot Connectors up to 160mm | PV05032 |
| 500mm Orifice Plate Flow Controller | Maximum 1m deep, 300mm deep sump, 4x Spigot Connectors up to 160mm | PV05033 |
| 500mm Orifice Plate Flow Controller | Maximum 1.5m deep, 300mm deep sump, 4x Spigot Connectors up to 160mm | PV05035 |



Orifice Plate Flow Control Chamber



Shear Connector

Permaties

| Permavoid Connection Accessories | |
|----------------------------------|--------|
| Description | Code |
| Shear Connector | PVSC |
| Permaties | PVCLIP |

| Preformed Spigot Connectors with Weldable Membrane | |
|--|---------|
| Description | Code |
| 110mm Flat Rigid Spigot Tank Adaptor | PV06200 |
| 160mm Flat Rigid Spigot Tank Adaptor | PV06201 |



Preformed Spigot Connector with weldable membrane



Permafilter Geotextile

| Geotextile Wraps* | | |
|------------------------|--------------------|---------|
| Description | Roll Dimensions mm | Code |
| Permafilter Geotextile | 2.4 x 100 | PV23002 |
| Permatex 300 | 5.25 x 65 | PV23006 |
| Capillary Geotextile | 6 x 100 | PV23008 |

*Geomembranes are also available.

| Flat Tank Spigot Connections | |
|--------------------------------------|---------|
| Description | Code |
| 110mm Flat Rigid Spigot Tank Adaptor | PV06200 |
| 160mm Flat Rigid Spigot Tank Adaptor | PV06201 |



Permachannel



Universal Permachannel Connector

| Permachannel | |
|---|---------|
| Description | Code |
| Permachannel complete with heel guard clip grating* | PV03001 |
| Permachannel End Cap | PV03002 |
| Universal Permachannel Connector | PV06305 |

*Comes with Universal Permachannel Connector, 1 per metre.

| Saddle Connections | | |
|---------------------------|---------------|---------|
| Description | Dimensions mm | Code |
| Saddle Connection 110/150 | 110 Spigot | PV06501 |
| Saddle Connection 110/300 | 110 Spigot | PV06502 |
| Saddle Connection 160/150 | 160 Spigot | PV06503 |
| Saddle Connection 160/300 | 160 Spigot | PV06504 |



Saddle Connection



Permaceptor

| Permaceptor Interceptor Treatment System | | |
|--|------------------|---------|
| Description | Dimensions mm | Code |
| Permaceptor GullyCeptor (not including cover or frame) | 1062 x 708 x 300 | PV04002 |

| Permavoid Rainwater Diffuser Unit* | | |
|--|-----------------|---------|
| Description | Dimensions mm | Code |
| Permavoid Rainwater Diffuser Unit x1 with a 110mm socket wrapped in a 2mm mesh | 708 x 354 x 150 | PV09011 |

*Other sizes are available, please see our Permavoid Technical Manual for further information.

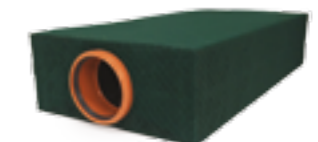

Permavoid Rainwater Diffuser Unit

Permavoid 85 & 150

Product codes: PVPP85 & PVPP150

Permavoid is a geocellular interlocking system designed for shallow groundwater storage or infiltration, to be used in place of traditional aggregate sub-base. The system has an exceptionally high compressive and tensile strength and bending resistance, with a proprietary jointing system to create a consistent structural raft within the pavement that is ideal for the shallow attenuation of surface water.



| Element | 85mm | 150mm |
|---|---|-------|
| PHYSICAL PROPERTIES | | |
| Weight per unit | 2.25kg | 3kg |
| Weight per square metre | 9kg | 12kg |
| Length | 708mm | 708mm |
| Width | 354mm | 354mm |
| Depth | 85mm | 150mm |
| SHORT TERM COMPRESSIVE STRENGTH | | |
| Vertical | 715kN/m ² | |
| Lateral | 156kN/m ² | |
| SHORT TERM DEFLECTION | | |
| Vertical | 1mm per 126kN/m ² | |
| Lateral | 1mm per 15kN/m ² | |
| TENSILE STRENGTH | | |
| Of a single joint | 42.4kN/m ² | |
| Of a single joint at (1% secant modulus) | 18.8kN/m ² | |
| Bending resistance of unit | 0.71kN/m | |
| Bending resistance of single joint | 0.16kN/m | |
| Volumetric void ratio | 92% | |
| Average effective perforated surface area | 52% | |
| OTHER PROPERTIES | | |
| Intrinsic permeability k | 1.0 x 10 ⁻⁵ | |
| Ancillary | Permavoid Permatie Permavoid Shear Connector | |
| Material | Polypropylene (PP) | |

Permavoid 85 & 150 key benefits

- High strength, high capacity, shallow sub-base replacement system
- Stormwater attenuation and/or infiltration system
- Used as part of a SuDS scheme to offer stormwater storage at shallow construction depths
- Units are manufactured from 90% recycled polypropylene (PP)
- 100% recyclable

Applications

The Permavoid units are suitable for use as a stormwater attenuation and/or infiltration system. The system comprises of single, interconnected cells which can be installed in the ground as part of sub-base formation. Permavoid is suitable for use in a range of applications including residential, industrial estates, car parks, sports pitches, roofs, basements, pedestrian areas and rainwater harvesting.

Performance

The structural load bearing capacity of the Permavoid units have been tested in accordance with the following European Standard: BS 7533-13:2009. The system's structural design life expectancy, based upon creep test data (tested in accordance with CIRIA guidelines) is as follows; For lightly loaded areas such as car parks, a design life of 50 years is achievable. For areas with prolonged HGV loading, a typical design life may only be 25 years, depending on the design of the pavement surfacing and structural layers over the tank.

Installation standard

All calculations for Permavoid units are based upon site-specific load cases, pavement construction types and thicknesses, soil cover and ground conditions and the suitability must therefore be approved for each project.

| Hydraulic Performance | | | | | | |
|---|---|----|----|----|----|----|
| 3 units wide, 1 unit deep (1.06m x 0.15m) | | | | | | |
| FREE DISCHARGE | | | | | | |
| Gradient % | 0 | 1 | 2 | 3 | 4 | 5 |
| Flow Rate 85mm l/m/s | 4 | 6 | 7 | - | - | - |
| Flow Rate 150mm l/m/s | 8 | 13 | 15 | 17 | 19 | 21 |

Permachannel

Product code: PVO3001

The Permachannel functions as a combined run-off collection, silt/oil interceptor and treatment system. The system is designed to be ideally laid with zero gradient to prevent the development of lateral velocities, stilling sheet run-off from each sub-catchment and encouraging silt deposition within each channel. The outlets discharge from the side of the channel via a weir and baffle component, which separates oils and prevents the effluent and silt from progressing beyond the channel into the rest of the drainage system.



Permachannel key benefits

- Gravity separation of oils and silts at source
- Trapped effluent naturally treated by aerobic digestion
- Can enhance water quality and eliminate the need for end of line petrol/oil interceptors
- The system complies with the regulations of the treatment train criteria in a SuDS scheme as defined in PPG3
- 100% recyclable

Applications

Permachannel is used for stormwater collection, interception and the treatment of associated pollutants. The system comprises of single or multiple interconnected channels appropriately located to collect surface water run-off from sub-catchments of predominantly impervious or pervious pavements. Permachannel is suitable for use in a range of applications including residential, industrial estates, car parks, sports pitches, roofs, basements, pedestrian areas and rainwater harvesting.

Performance

Permachannel is rated to D400 loading in accordance with BS EN 124:1994 when installed with a concrete bed and haunch in accordance with site specific construction details.

Installation standard

Permachannel must be installed on a load bearing concrete bed and haunch in accordance with site specific construction details.

| Element | Value |
|---|--|
| PHYSICAL PROPERTIES | |
| Weight per unit | 29kg |
| Length | 1000mm |
| Width | 150mm |
| Depth | 210mm |
| Material | Polymer concrete |
| Grating | Ductile iron standard steel safe |
| Catchment area | 30m ² |
| Loading | Rated to D400 |
| Average effective perforated surface area | Polymer concrete |
| Chemical resistance | The polymer concrete has a capillary-free, non-porous sealed structure, which makes it naturally resistant to most chemicals (i.e. petrol, oils and acids) |

Effluent concentrations are below PPG3 Class I requirements.

Note: Ancillary universal channel connector 40mm diameter.

For our full range of Permavoid datasheets and standard details, please visit our website www.polypipe.com/toolbox

Permavoid Biomat Product code: PV150BM

Permavoid Biomat is a high strength geocellular unit, designed for use with the Permavoid system, containing a low density, oil treating, geosynthetic floating mat (biomat). The biomat floats on water and is designed to intercept and treat any potential residual emulsified oils that may be present within the surface water. The use of Permavoid Biomat provides additional oil retention and water treatment capability to an underground water storage system.

Permavoid Biomat key benefits

- Secondary treatment phase for potential residual hydrocarbons
- Pollutant-intercepting floating mat
- Same size as Permavoid so can be incorporated into Permavoid attenuation designs
- Floating medium maintained at air-water interface allowing optimum conditions for aerobic degradation
- Self maintaining, degrades residual oils by absorption and aerobic digestion
- Units are manufactured from 90% recycled polypropylene (PP)
- 100% recyclable

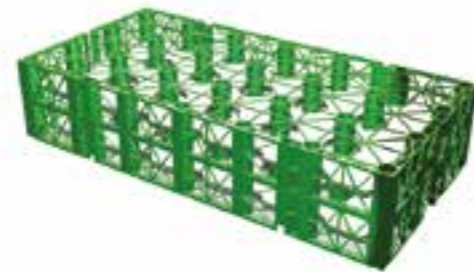

Installation standard

All calculations for Permavoid Biomat units are based upon site-specific load cases, pavement construction types and thickness, soil cover and ground conditions and the suitability must therefore be approved for each project.

| Element | Value |
|---|---|
| PHYSICAL PROPERTIES | |
| Weight per unit | 3kg |
| Length | 708mm |
| Width | 354mm |
| Depth | 150mm |
| SHORT TERM COMPRESSIVE STRENGTH | |
| Vertical | 715kN/m ² |
| Lateral | 156kN/m ² |
| SHORT TERM DEFLECTION | |
| Vertical | 1mm per 126kN/m ² |
| Lateral | 1mm per 15kN/m ² |
| TENSILE STRENGTH | |
| Of a single joint | 42.4kN/m ² |
| Of a single joint at (1% secant modulus) | 18.8kN/m ² |
| Bending resistance of unit | 0.71kN/m ² |
| Bending resistance of single joint | 0.16kN/m ² |
| Volumetric void ratio | 92% |
| Average effective perforated surface area | 52% |
| OTHER PROPERTIES | |
| Intrinsic permeability (k) | Minimum 1.0 x 10 ⁻⁵ |
| Oil retention | 56g/m ² |
| Effluent discharge at max. oil loading | 10ppm |
| Ancillary | Permavoid Permatie Permavoid Shear Connector |

Applications

Permavoid Biomat units are an effective water treatment component suitable for use as a stormwater attenuation and/or infiltration system. The system comprises single, interconnected cells which can be installed in the ground as part of a sub-base formation. Permavoid Biomat is suitable for use in a range of applications including residential, industrial estates, car parks, sports pitches, roofs, basements, pedestrian areas and rainwater harvesting.

Performance

The structural load bearing capacity of the Permavoid Biomat units have been tested in accordance with the following European Standard: BS 7533-13:2009. The system's structural design life expectancy, based upon creep test data (tested in accordance with CIRIA guidelines) is as follows: For lightly loaded areas such as car parks, a design life of 50 years is achievable. For areas with prolonged HGV loading, a typical design life may only be 25 years, depending on the design of the pavement surfacing and structural layers over the tank.

Permafilter Geotextile Product code: PV23002

Permafilter Geotextile is a non-woven, dimpled, needle-punched geotextile that has been specifically designed for hydrocarbon pollution treatment in sustainable drainage systems (SuDS) and other civil engineering applications.

Permafilter Geotextile key benefits

- Captures residual hydrocarbons
- Removes pollutants by biodegradation
- 100% recyclable
- Enhances water quality when used as part of a source control SuDS and eliminates the need for end of line petrol/oil interceptors
- Designed to be self-maintaining for the life of the installation



Applications

Permafilter Geotextile is suitable for use in a range of applications including residential, industrial estates, swales, sports pitches, car parks, roofs, basements, pedestrian areas and rainwater harvesting.

Performance

The dimpled geotextile comprises of a proprietary blend of polyester fibres that incorporates hydrophilic (water attracting and oil repellent) and hydrophobic (oil attracting and water repellent) properties to achieve superior oil retention. Permafilter Geotextile is capable of retaining oil contamination ranging from daily car drip losses, up to catastrophic spillages i.e. originating from car oil-sump failures. The entrapped hydrocarbons are biodegraded by naturally occurring microorganisms providing a self-cleansing mechanism.

Laying generally

Permafilter will be laid to suit site specific requirements. Overlaps shall be a minimum of 300mm or heat sealed. Ensure geotextile is clean and debris free before installing Permavoid.

| Element | Value |
|--|--------------------------|
| PHYSICAL PROPERTIES | |
| Weight per unit | 300g/m ² |
| Roll length | 100m |
| Roll width | 2.4m |
| Roll weight | 72kg |
| MECHANICAL PROPERTIES | |
| Tensile strength EN10319 (md/cmd) | 9/12kN/m |
| Static puncture (CBR test) EN12236 | 1575N |
| HYDRAULIC PROPERTIES | |
| Water permeability EN ISO 11058 | 57 l/m ² /s |
| OTHER PROPERTIES | |
| Air permeability | 1000 l/m ² /s |
| Max. oil retention | 6l/10m ² |
| Effluent discharge at max. oil loading | 10ppm |
| Material | Modified polyester |

For our full range of Permavoid datasheets and standard details, please visit our website www.polypipe.com/toolbox

Polystorm range

The Polystorm geocellular range is designed to provide retention, attenuation or infiltration at a variety of depths. It is ideally suited to deeper applications and can accommodate a wide range of traffic loadings, from pedestrianised areas to large HGV parks.

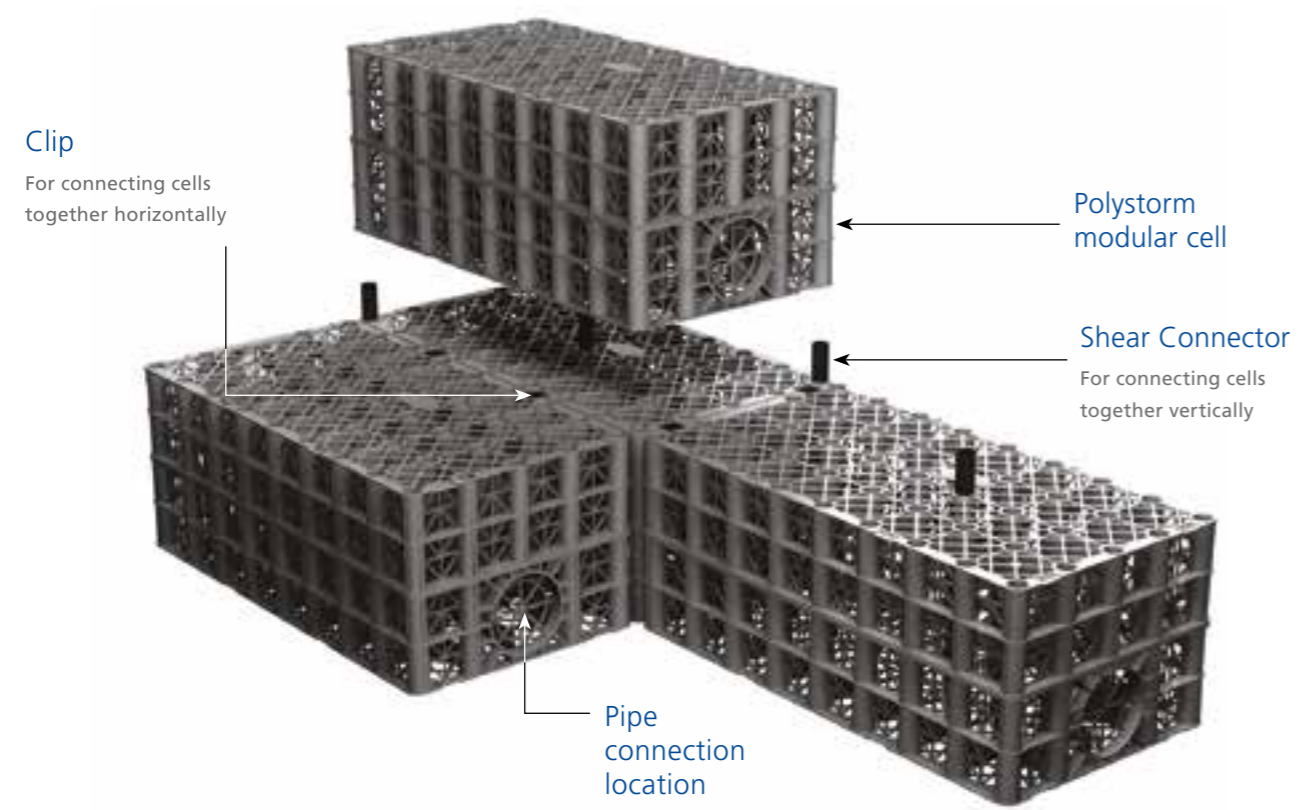







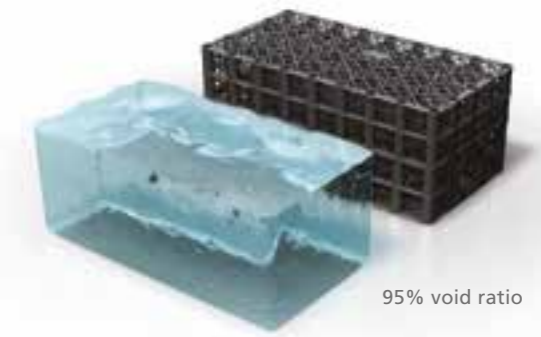

Polystorm modular cells are joined together with Clips and Shear Connectors to provide water storage structures. Each cell has a 95% void ratio to provide a highly efficient, SuDS compliant water retention, attenuation or infiltration solution. For projects that have high sustainability targets, Polystorm is also available manufactured from recycled materials.

Polystorm system key benefits

- 95% void ratio providing greater water storage capacity and reduced excavation and disposal costs
- BBA approved for Polystorm Lite, Polystorm-R and Polystorm. BBA pending for Polystorm Xtra
- Modular units allow flexibility of shape, making it ideal for shallow excavation systems, narrow strips or for use in restricted areas
- Light weight yet robust, affording excellent Health and Safety and installation benefits
- Unique rounded corners make it easy to handle and reduce likelihood of punctures to membranes
- 100% recyclable at the end of its useful life
- Spans from 20 tonnes per square metre load bearing capacity, up to a maximum of 80 tonnes per square metre load bearing capacity
- The range can be designed for non-trafficked, trafficked or heavily trafficked applications
- Suitable for retention, attenuation and infiltration systems
- Up to 60 year design life
- Polystorm modular cells manufactured from polypropylene
- Polystorm Access manufactured from MDPE







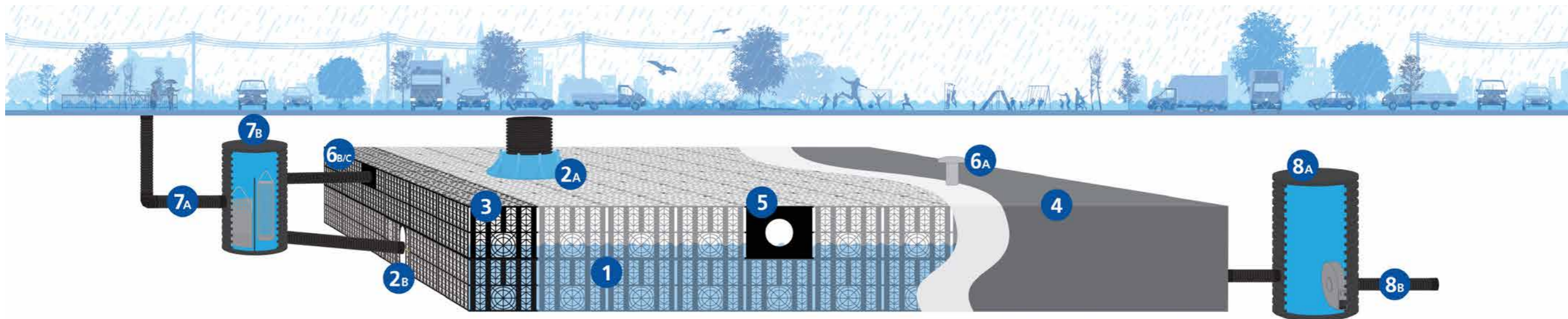

Polystorm systems

| | | | | | |
|---|---|---|---|---|---|
|   <p>Polystorm Lite Landscaped/pedestrian areas</p> |   <p>Polystorm-R Trafficked areas</p> |   <p>Polystorm Trafficked areas</p> |  <p>Polystorm Xtra Heavy trafficked, deep or reduced cover areas</p> |  <p>Polystorm Inspect Lateral maintenance and inspection</p> |  <p>Polystorm Access Vertical maintenance and inspection</p> |
|---|---|---|---|---|---|

An 8 step guide to a total Polystorm system



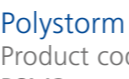

1 Select modular cell

| | | | |
|--|---|---|---|
|   Polystorm Lite Product code: PSM2 Landscaped/pedestrian Polystorm Lite has been specifically designed for non-trafficked applications. With a 20 tonnes per square metre compressive strength, it will support general maintenance vehicles such as grass cutters. Polystorm Lite is typically used in landscaped and pedestrianised areas at lower depths. See page 80 |   Polystorm-R Product code: PSM1A Trafficked The standard Polystorm cell for trafficked and loaded applications at greater depths has a compressive strength of 61 tonnes per square metre and the added benefits of a higher recycled material content. Ideally suited for housing, commercial and infrastructure projects. See page 81 |   Polystorm Product code: PSM1 Trafficked The Polystorm cell, made of virgin material, has a 44 tonnes per square metre compressive strength and is ideally suited for trafficked and loaded areas at greater depths. See page 82 |   Polystorm Xtra Product code: PSM3 Heavy trafficked, deep or reduced cover Designed for use in deeper burial depths for heavily trafficked applications, Polystorm Xtra has a compressive strength of 83 tonnes per square metre, making it suitable for use in very heavily trafficked areas, deep applications and where reduced cover is required. See page 83 |
|--|---|---|---|

Connection accessories

| | | |
|--|---|--|
|  • Shear Connectors Product code: PSMSC |  • Clips Product code: PSMCLIP |  • Brick Bond Connectors Product code: PSMBBSC |
|--|---|--|

2 Select access if maintenance and inspection is required

| | |
|---|---|
|  | 2A Polystorm Access (see page 84 for product codes) Polystorm Access provides a 1m x 0.5m vertical shaft within a Polystorm geocellular structure to enable surface access for remote camera inspection and maintenance activities such as flushing and rodding. The system consists of a 500mm diameter shaft which extends from surface level to the top of a Polystorm structure, at which point a turret provides an interface between the shaft and the inspection chamber within the Polystorm structure. |
|  | 2B Polystorm Inspect – Product code: PSM4 The Polystorm Inspect cell is complementary to the Polystorm range of modular cell solutions. Its primary purpose is to provide a tunnel along the length of a fully installed Polystorm structure to enable access for inspection and maintenance. Polystorm Inspect is a high strength thermoplastic cell which evenly distributes its load through the Polystorm structure. The tunnel end is left open by default but the unit can be closed off if required by clipping into place the moulded end plate. For purposes of identification the cell features a yellow centre section and end plate. See page 85 |

3 Select if treatment is required

| | |
|---|--|
|  | Permavoid Medium Duty with Biomat – Product code: PSM1BM Comprising of a high strength, low density, oil treating geosynthetic floating mat for use with the Polystorm range of modular geocellular units. For multi-stage oil interception the Permavoid Medium Duty with Biomat can be used in conjunction with Permachannel (linear treatment) or a pre-fabricated RIDGISTORM Separate Weir and Baffle Chamber (point treatment). |
|---|--|

8 step guide continued...

4 Select wrap

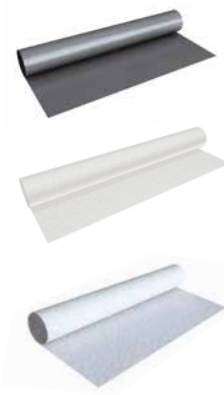

Geomembrane for retention & attenuation

An impermeable membrane for wrapping around geocellular structures to form watertight tanks. This is then wrapped in a geotextile which protects the geomembrane during installation.

Permafilter Geotextile for infiltration Product code: PV23002

This geotextile has been specifically designed to remove hydrocarbon pollution, treating the captured water before infiltrating it into the ground for treatment and infiltration.

See page 73

Permatex 300 for infiltration or protection Product code: PV23006

A non-woven protective geotextile that can be used for soakaway infiltration solutions or to wrap a geocellular tank before a geomembrane is installed for added protection.

5 Flange Connections

A flange adaptor is attached at both the inlet and outlet points to allow water to enter and exit the tank.



Flange Adaptor to EN1401



Polystorm cell with Drainage Flange Connection

- 5a. Polystorm cells with Flange Connections to Ridgidrain drainage pipes: PSMCRD225 (225mm), PSMCRD300 (300mm), PSMCRD375 (375mm)
- 5b. Polystorm Inspect cells with Flange Connections to Ridgidrain drainage pipes: PSM4CRD225 (225mm), PSMCRD300 (300mm)
- 5c. Flange Adaptor to EN1401: PSMFA110 (110mm), PSMFA160 (160mm)
- 5d. Flange Adaptor to Ridgidrain: PSMFA150 (150mm), PSMFA225 (225mm), PSMFA300 (300mm), PSMFA375 (375mm), PSMFA450 (450mm), PSMFA600 (600mm)

6 Venting

Every attenuation tank requires at least one vent to maximise hydraulic performance, reduce stress on encapsulating geomembranes and avoid stagnant water. This can be done by installing either a Vent Cowl or a connection pipe to vent air directly into an upstream chamber.

- 6A** Vent Cowl
Product code: SCV40
To vent air above ground.

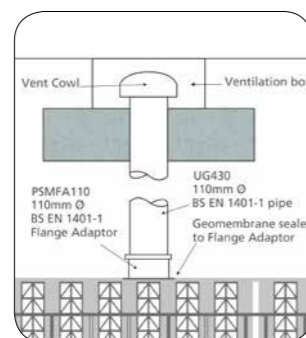

- 6B** BS EN1401-1 pipe
Product code: UG430



- 6C** 150mm Ridgidrain pipe
Product code: RD150X6PE
For ventilation into the upstream chamber.



7 Associated upstream products

7A Ridgidrain

Ridgidrain can be utilised within a Polystorm system by allowing captured surface water to enter the attenuation or infiltration tank.



7B RIDGISTORM Separate Chambers

RIDGISTORM Separate Chambers are self-cleaning and prevent the ingress of debris, silt, organic and even other particles into the Polystorm structure, extending its useful life.

Silt Traps

Small diameter (320-460mm)

Silt traps are available from the RIDGISTORM Separate Silt Traps range.

See page 52

Catchpits

Larger diameter (450-3000mm)

Catchpits are available from the RIDGISTORM Separate range.

See page 53

Weir and Baffle Chambers & Filter Chambers

In addition to silt traps and catchpits, we also offer RIDGISTORM Separate Weir and Baffle Chambers and RIDGISTORM Separate Filter Chambers with additional treatment features.

See page 54 - 55



8 Associated downstream products

8A RIDGISTORM Check

A choice of Vortex or Orifice Plate Flow Control Chambers for precise control of site discharge rates.

See page 48



RIDGISTORM Control

Pre-fabricated structured wall chambers which feature 'in-line' system components such as penstocks, gate valves or flap valves to control system flows and facilitate maintenance.

See page 50

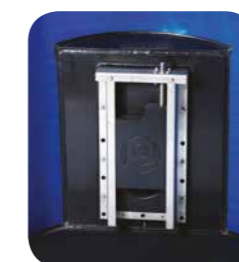

8B Ridgidrain

Ridgidrain can be utilised to drain away stored water from a Polystorm attenuation tank.



Polystorm Lite Product code: PSM2

Polystorm Lite has been specifically designed for non-trafficked applications such as landscaped areas, pedestrianised areas or public open spaces. With a compressive strength of up to 20 tonnes/m², it is able to support general maintenance vehicles such as grass cutters. Polystorm Lite can be used for retention, attenuation and infiltration applications.



Polystorm Lite key benefits

- Compressive strength of 20 tonnes/m²
- Ideal for retention, attenuation or infiltration applications with a suitable geomembrane or geotextile
- Designed for landscaped, pedestrian or other non-loaded applications
- BBA approved
- Visual and maintenance access can be achieved when used in conjunction with Polystorm Access and Inspect
- Can be used as part of a value engineered hybrid system with Polystorm-R, Polystorm and Polystorm Xtra
- Integrated inlet and outlet
- 3D flow throughout the structure
- 95% void ratio
- 100% recyclable
- 50 years creep limited life expectancy

| Element | Value |
|--|---------------------------------|
| TECHNICAL SPECIFICATION OVERVIEW | |
| Product code | PSM2* |
| Length | 1m |
| Width | 0.5m |
| Depth | 0.4m |
| Total volume | 0.2m ³ |
| Unit weight | 7kg |
| Unit storage volume | 0.19m ³ (190 litres) |
| Void ratio | 95% |
| Vertical compressive strength | Maximum 200kN/m ² ** |
| Lateral compressive strength | Maximum 40kN/m ² ** |
| Short-term vertical deflection | 43kN/m ² per mm |
| Short-term lateral deflection | 6.4kN/m ² per mm |
| Maximum burial depths: Non-trafficked | 2.5m*** |

* Each unit includes 4 Clips and 2 Shear Connectors.

** Compressive strength at yield, maximum recommended value for design purposes.

*** Based on ground conditions being dense sand and gravel with no groundwater present, using the calculation methodology detailed within CIRIA C680 (2008). Where ground conditions differ, please consult our water management solutions Technical Department on +44 (0) 1509 615100.



For our full Polystorm Lite datasheet, please visit our website www.polypipe.com/toolbox



Note: Exact colour may vary due to recycled material.

| Element | Value |
|---|---|
| TECHNICAL SPECIFICATION OVERVIEW | |
| Product Code | PSM1A* |
| Length | 1m |
| Width | 0.5m |
| Depth | 0.4m |
| Total volume | 0.2m ³ |
| Unit weight | 9kg (approx) |
| Unit storage volume | 0.19m ³ (190 litres) |
| Void ratio | 95% |
| Vertical compressive strength | 610kN/m ² ** |
| Lateral compressive strength | 63kN/m ² ** |
| Short-term vertical deflection | 60kN/m ² per mm |
| Short-term lateral deflection | 4.4kN/m ² per mm |
| Estimated long term vertical deflection (creep) | 0.2798 Ln (design life in hrs) +0.485 [Based on an applied test load = 162 kN/m ²] Creep data limit 60 years |
| Estimated long term lateral deflection (creep) | 1.0192 Ln (design life in hrs) -3.864 [Based on an applied test load = 30.8 kN/m ²] Creep data limit 60 years |

Note: Polystorm-R is ideal for use in trafficked and pedestrian applications subject to a structural design check and suitable installation conditions.

* Each unit includes 4 Clips and 2 Shear Connectors.

** Compressive strength at yield, maximum recommended value for design purposes.

Polystorm-R Product code: PSM1A

Polystorm-R has been designed to provide retention, attenuation or infiltration in trafficked and loaded areas. It has a 61 tonnes/m² compressive strength and is manufactured from over 90% recycled material content.

Polystorm-R key benefits

- Made from specially selected and controlled recycled materials
- Environmentally friendly, sustainable solution
- Compressive strength of 61 tonnes/m²
- Ideal for retention, attenuation or infiltration applications/schemes with a suitable geomembrane or geotextile
- BBA approved
- Can be used as part of a value engineered hybrid system with Polystorm Lite, Polystorm and Polystorm Xtra
- Integrated inlet and outlet
- 3D flow throughout the structure
- 95% void ratio
- 60 years creep limited life expectancy

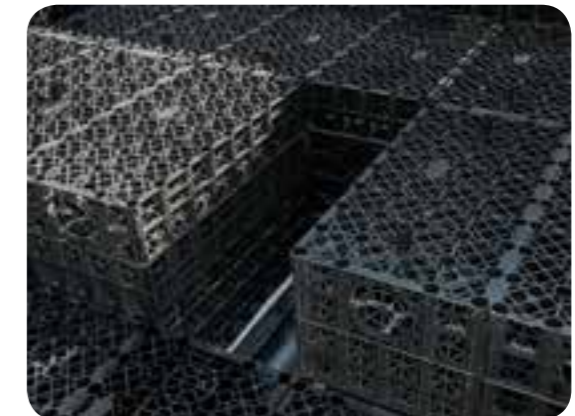

For our full Polystorm-R datasheet, please visit our website www.polypipe.com/toolbox

Polystorm Product code: PSM1

Polystorm has a 44 tonnes/m² compressive strength and is ideally suited for retention, attenuation or infiltration under trafficked or loaded areas such as car parks and housing and commercial developments.

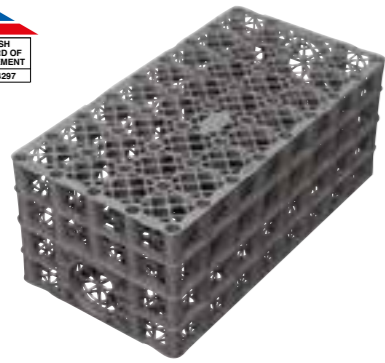

| Element | Value |
|---|---------------------------------|
| TECHNICAL SPECIFICATION OVERVIEW | |
| Product code | PSM1* |
| Length | 1m |
| Width | 0.5m |
| Depth | 0.4m |
| Total volume | 0.2m ³ |
| Unit weight | 9kg |
| Unit storage volume | 0.19m ³ (190 litres) |
| Void ratio | 95% |
| Vertical compressive strength | Maximum 440kN/m ² ** |
| Lateral compressive strength | Maximum 63kN/m ² ** |
| Short-term vertical deflection | 83kN/m ² per mm |
| Short-term lateral deflection | 4.2kN/m ² per mm |
| Maximum burial depths: | |
| Light trafficked | 3.7m*** |
| Non-trafficked | 3.8m*** |

* Each unit includes 4 Clips and 2 Shear Connectors.

** Compressive strength at yield, maximum recommended value for design purposes.

*** Based on ground conditions being dense sand and gravel with no groundwater present, using the calculation methodology detailed within CIRIA C680 (2008). Where ground conditions differ, please consult our water management solutions Technical Department on +44 (0) 1509 615100.

Polystorm key benefits

- Compressive strength of 44 tonnes/m²
- Ideal for retention, attenuation or infiltration applications with a suitable geomembrane or geotextile
- Designed for trafficked and loaded conditions
- BBA approved
- Visual and maintenance access can be achieved when used in conjunction with Polystorm Access and Inspect
- Can be used as part of a value engineered hybrid system with Polystorm Lite and Polystorm Xtra
- Integrated inlet and outlet
- 3D flow throughout the structure
- 95% void ratio
- 100% recyclable
- 50 years creep limited life expectancy



For our full Polystorm datasheet, please visit our website www.polypipe.com/toolbox

Polystorm Xtra Product code: PSM3

Designed for use in deeper burial depths, heavily trafficked applications and where areas of reduced cover are required, Polystorm Xtra has a compressive strength of 83 tonnes/m², making it suitable for use in very heavily trafficked areas like lorry parks and industrial access roads.



| Element | Value |
|---|----------------------------------|
| TECHNICAL SPECIFICATION OVERVIEW | |
| Product code | PSM3* |
| Length | 1m |
| Width | 0.5m |
| Depth | 0.21m |
| Total volume | 0.105m ³ |
| Unit weight | 6kg |
| Unit storage volume | 0.0986m ³ (98 litres) |
| Void ratio | 94% |
| Vertical compressive strength | Maximum 834kN/m ² ** |
| Lateral compressive strength | Maximum 93kN/m ² ** |
| Short-term vertical deflection | 97.8kN/m ² per mm |
| Short-term lateral deflection | 7.1kN/m ² per mm |
| Maximum burial depths: | |
| Heavy trafficked | 4.8m*** |
| Light trafficked | 5.3m*** |
| Non-trafficked | 5.45m*** |

* Each unit includes 4 Clips and 2 Shear Connectors.

** Compressive strength at yield, maximum recommended value for design purposes.

*** Based on ground conditions being dense sand and gravel with no groundwater present, using the calculation methodology detailed within CIRIA C680 (2008).

Where ground conditions differ, please consult our water management solutions Technical Department on +44 (0) 1509 615100.

Polystorm Xtra key benefits

- Compressive strength of 83 tonnes/m²
- Ideal for retention, attenuation or infiltration applications/schemes with a suitable geomembrane or geotextile
- Designed for heavy trafficked conditions which require shallow excavations or deep burial depths
- Can be used as part of a value engineered hybrid system in non-loaded and light traffic applications with Polystorm Lite, Polystorm-R and Polystorm
- Installed with blue lid facing down for increased strength
- Undergone testing in accordance to BBA certification
- Integrated inlet and outlet
- 3D flow throughout the structure
- 94% void ratio
- 100% recyclable

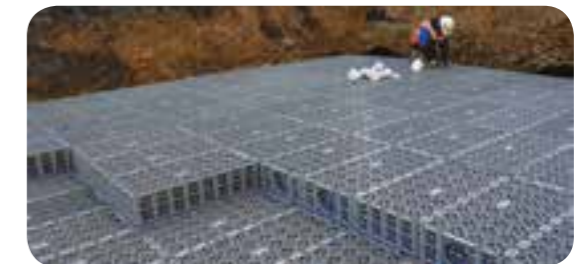

For our full Polystorm Xtra datasheet, please visit our website www.polypipe.com/toolbox

Polystorm Access

Product codes: See chart below

Polystorm Access provides a 1m x 0.5m shaft within a Polystorm geocellular structure to enable surface access for remote camera inspection and maintenance activities, such as flushing and rodding.

The system consists of a 500mm diameter shaft which extends from surface level to the top of a Polystorm structure, at which point a turret provides an interface between the shaft and the inspection chamber within the Polystorm structure. At the bottom of the chamber, a base unit interlocks with the surrounding layer of Polystorm cells whilst supporting the geomembrane. A 350mm reduced access shaft cap is provided to comply with inspection chamber regulations.

Polystorm Access is suitable for use with Polystorm Lite, Polystorm-R, Polystorm and Polystorm Xtra and may be combined with Polystorm Inspect for full length remote inspection and maintenance.

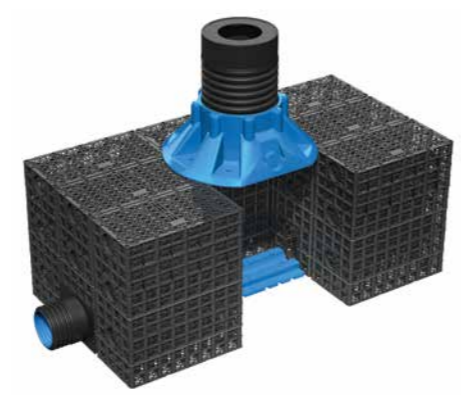

Please note: The Polystorm Access turret and base assembly are black. They are shown blue for illustration purposes.

Polystorm Access key benefits

- Meets minimum 450mm width requirement for inspection chamber access, with 350mm reduced access where regulations dictate
- Integrated solution; can be used with Polystorm Inspect to monitor internal volume of geocellular structure
- Base unit provides smooth transition between Polystorm Inspect units
- Multiple inspection configurations can be achieved when used in conjunction with Polystorm Inspect
- Manufactured from polyethylene for light weight, ease of handling and high strength
- Sustainability: All components 100% recyclable after use

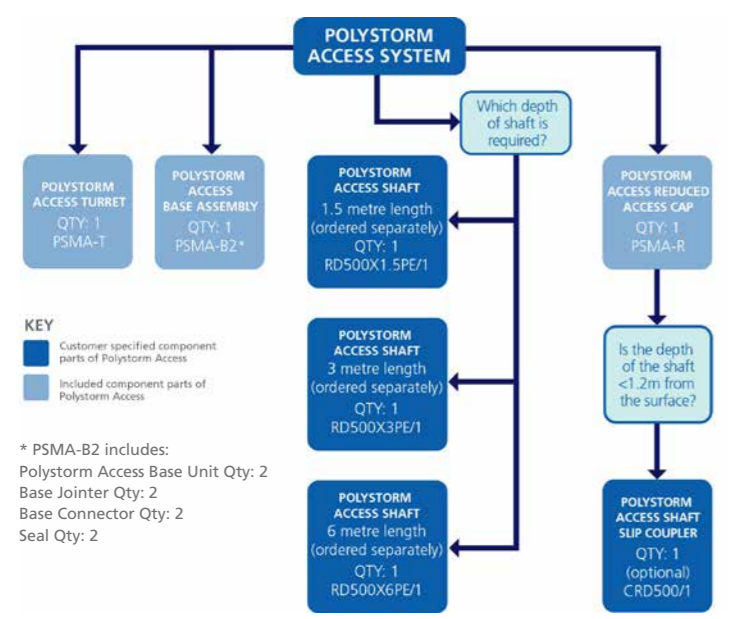
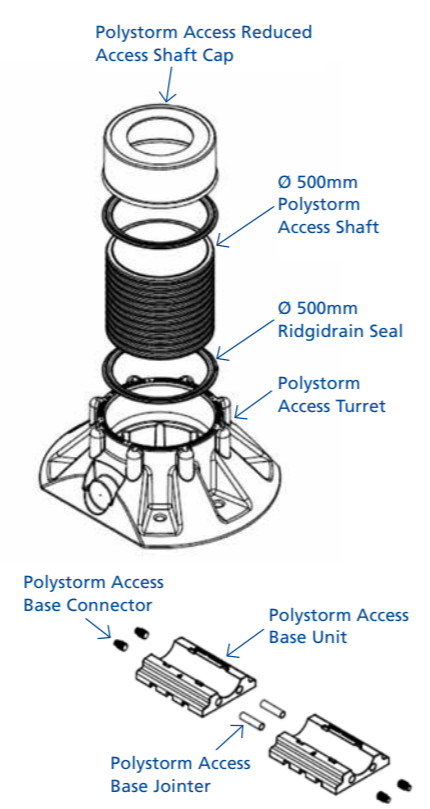

* PSMA-B2 includes:
 Polystorm Access Base Unit Qty: 2
 Base Joiner Qty: 2
 Base Connector Qty: 2
 Seal Qty: 2

For our full Polystorm Access datasheet and installation guide, please visit our website www.polypipe.com/toolbox

Polystorm Inspect

Product code: PSM4

The Polystorm Inspect cell is complementary to the Polystorm range of modular cell solutions. Its primary purpose is to provide a tunnel along the length of a fully installed Polystorm structure to enable access for inspection and maintenance.

Polystorm Inspect is a high strength, thermoplastic cell which evenly distributes its load through the Polystorm structure. The tunnel end is left open by default but the unit can be closed off if required by clipping into place the moulded end plate. For purposes of identification, the cell features a yellow centre section and end plate.

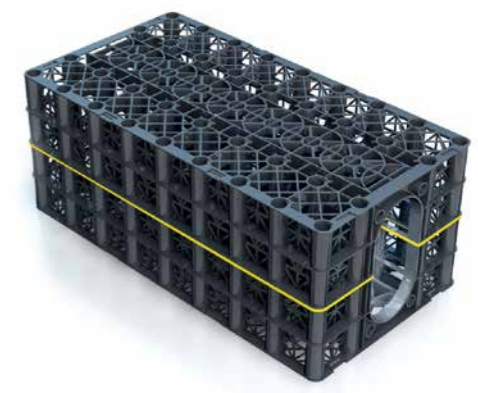

Polystorm Inspect key benefits

- Creates a horizontal tunnel running through the middle of the tank to provide access for inspection and maintenance, i.e. jetting and rodding
- Can be used with Polystorm Lite, Polystorm-R and Polystorm
- Tunnel can be used as a flow inlet track achieving greater stormwater flow distribution within the unit
- Large access tunnel (height 320mm and width 172mm nominal) – allows maximum field of vision while maintaining the system's structural performance
- High strength to weight ratio
- Light weight cell allows easier handling and reduced Health and Safety risk
- Utilises the same Shear Connectors and Clips as the Polystorm range
- The tunnel restricts the dissipation of silt in to the overall structure making inspection and maintenance easier
- Polystorm Inspect cells with 225mm or 300mm inlets are available (PSM4CRD225 or PSM4CRD300)

| Unit type | Polystorm Inspect* |
|---|--------------------------------------|
| TECHNICAL SPECIFICATION OVERVIEW | |
| Product code | PSM4 |
| Length | 1m |
| Width | 0.5m |
| Depth | 0.4m |
| Total volume | 0.2m ³ |
| Unit weight | 11.6kg* |
| Cube storage volume | 0.188m ³ (188 litres) |
| Volumetric void ratio | 94% |
| Vertical compressive strength at yield | Minimum 440kN/m ² |
| Lateral compressive strength at yield | Minimum 63kN/m ² |
| Short-term vertical deflection | Minimum 70.1kN/m ² per mm |
| Estimated long term vertical deflection (creep) | 0.6113Ln (design life in hrs) |

Note: The table above is applicable to PSM4 without the end plate.
 * Approximate weight.

For our full Polystorm Inspect datasheet, please visit our website www.polypipe.com/toolbox

Case study – Coronation Street



A shallow stormwater management system using Permavoid was specified for use as part of the construction of the new Coronation Street set

Permavoid was the ideal choice for the project because the existing site was brownfield with a high water table and shallow outfall and our system was capable of providing an innovative shallow solution. The project saw 28 separate Permavoid attenuation tanks installed throughout the site, providing a combined storage capability of 420,000 litres.

High strength cells were combined with strategically located Permachannel and Permavoid Biomat cells that capture, treat, store and control rainwater discharge at source. The system also incorporates a unique jointing mechanism that forms an interlocking 'raft' that supports structural loads across the heavily trafficked areas of the Coronation Street set. The shallow depth of the solution not only negated the need for pumping stations, it also reduced the need for temporary works, which in turn reduced installation and labour costs as well as Health and Safety risks.



Case study – Newcastle City Council



Polypipe supplied its Permavoid products to Newcastle City Council for a DEFRA funded flood alleviation scheme at Acomb Crescent, Fawdon

The housing development had previously flooded during heavy rainfall due to interaction between surface water sewers and the water level in the nearby Ouseburn River. To help prevent future flooding, our Permavoid system was installed under a recreational area between a road and the river.

The water management solution comprised of a Permavoid shallow geocellular system, which featured the use of Permavoid Biomat. Permavoid Biomat was incorporated into the design in order to trap and retain any residual and emulsified oils that may be present in surface water from the road before discharging directly into the river.

As the surface water enters the Permavoid attenuation system through kerb drainage, the Permavoid cells had to be installed below the level of the road at the same time as being above the normal river level.

As the system is designed for shallow applications, the burial depths could be tightly controlled to ensure the optimum attenuation performance was achieved.

The units provide storage until river levels fall and gravity discharge can begin again. River water is prevented from entering the system by a non-return valve on the outlet.

Acomb Crescent is an area which is particularly prone to flooding, with limited available space for a solution. Our Permavoid system was ideal for this project and our Technical Team were on hand to design a bespoke solution for the client.

Using Permavoid products on this project not only enabled us to provide an effective drainage solution, but also helped to ensure that the water is returned to the watercourse in a clean, unpolluted form.

Case study – East Kent College



Polypipe tops the class in new College Development

A new centre for Environmental Technologies, at East Kent College, has benefited from one of our bespoke Polystorm geocellular drainage solutions. Working closely with groundworker Stevens Construction, our Water Management Solutions Team created a Polystorm infiltration structure underneath a car park of the College's new building.

Our Polystorm Access and Inspect products were used in conjunction with Polystorm-R modular cells to create a 96m³ structure.

The soakaway tank is used to store surface water collected from the new study centre and disperse it at an even rate into the surrounding soil. Polystorm Access and Polystorm Inspect products feature tunnels specifically designed to allow access to be built into a Polystorm geocellular structure, for remote camera inspection and maintenance activities when required.

Both products were used in conjunction with each other to provide horizontal and vertical access simultaneously. The light weight nature of our plastic products meant that the site's lack of vehicle access did not prove an issue as the Polystorm cells could be moved onto site easily.

Case study – David Wilson Homes



Polypipe experts helped David Wilson Homes gain Section 104 approval for its new residential development in Essex

David Wilson Homes' large-scale Ashcroft Place development in Thundersley, Essex, required a bespoke sustainable drainage systems (SuDS) to meet Section 104 requirements. We were able to provide an effective and easy to install drainage solution for the project's Main Contractor J L Knight, which quickly gained Section 104 approval from the local water authority.

Polystorm-R modular cells, Ridgistorm-XL large diameter pipe and a RIDGISTORMCheck Vortex Flow Control Chamber were all utilised on the site, forming a number of attenuation tanks to store surface water and then gradually release it back into the sewer system.

A total of 2,790 Polystorm-R Cells were used to create 5 separate attenuation tanks for the site, with a combined capacity to store up to 558m³ of stormwater.

Ridgistorm-XL pipes in 750mm and 900mm diameters were utilised as single straight runs under the road, with 1200mm diameter Ridgistorm-XL pipes installed by the side of the road to form a bespoke multi-leg pre-fabricated attenuation tank.

We designed and manufactured Ridgistorm-XL in a variety of stiffness classes in order to overcome the issue of varying loading and ground conditions. Taking this approach and by combining this with Polystorm-R cells, means that the site is now protected against both 1 in 30 year and 1 in 100 year storm events.

The completed Ridgistorm-XL large diameter pipe system has a total length of 650m and was designed in accordance with the Specification for Highway Works and Sewers for Adoption.

Rainwater harvesting overview

Climate change and population growth are reshaping how we think about rainwater. With UK temperatures predicted to rise over the next 70 years, climate change is driving the need for solutions to retain and reuse rainfall and surface water.



Rainwater harvesting key benefits

- Tank sizes from 1,500 to 300,000 litres (smaller tanks available upon request)
- Leaf filter within engineered chambers to suit specific project needs
- Complete range of additional items such as duty standby and booster systems
- Mains water back-up
- Helps to reduce your carbon footprint by lowering the volume of water from local treatment works
- Tank system supplied with filters, pumps, valves, component set and factory fitted inlet, calmed inlet and outlet connections
- Offers bespoke design solutions
- Filter uses first flush principle
- Manifold system available for multiple dwellings
- Water filtered to 110 microns
- Increases water capture by using specialist filters such as RIDGISTORM-X4

By harvesting rainwater, a constant supply of water can be maintained, whatever the weather. In periods of heavy rain, rainwater harvesting takes pressure off local drains and limits the potential of flooding. It also stores plentiful supplies of water for use during dry periods.

Why harvest rainwater?

- Population growth and rising consumption is increasing the demand for water
- Climate change is creating pressure to conserve water
- Legislation is enforcing the need to conserve water
- Higher water charges and water metering are predicted
- We use up to 70% more water now than we did 30 years ago

Commercial systems

If you are interested in rainwater harvesting systems for commercial applications, including schools, office blocks, warehouses, hotels, and other multi-occupancy venues please contact **Polypipe Terrain** on **+44 (0) 1622 795200**.

Harvested rainwater can be used for:

- Toilet flushing
- Irrigation and landscape watering
- Cooling and sprinkler systems
- Vehicle washing
- Domestic and commercial laundry

Residential systems

If you are interested in rainwater harvesting systems for residential use, please contact **Polypipe Building Products** on **+44 (0) 1709 770000**.

Contents

| SECTION 6 | Rainwater harvesting | |
|-----------|-------------------------------|---------|
| | Rainwater harvesting overview | 90 - 91 |
| | Rainstream | 92 - 93 |

Rainstream

Rainstream from Polypipe offers a range of highly effective solutions for the retention, filtration and reuse of rainwater.

Rainstream for commercial applications

Large-scale solutions have been installed on a wide variety of projects, from Ministry of Defence sites through to retail developments. Our team, consisting of fully-qualified designers and engineers, have the technical pedigree and manufacturing capability to design solutions to meet any site requirements.

Assessment and advice

Our experts offer a wide range of advice and support to help explain the solutions available for the effective capture, storage, filtration and reuse of rainwater. Services include: assessment, tank sizing calculations, technical detail and system schematics.

Together these services ensure that customers receive the most suitable and effective rainwater reuse system for their particular application.

Rainstream Home XL for residential applications

A key benefit of Rainstream Home XL is that it will never need a concrete surround in non-loaded applications, even in cases of a high water table. All that is needed is a concrete base which the tanks are strapped to. It provides a simple solution to the complex problem of rising water tables and changing weather patterns. As most systems are installed during the summer months when water tables are at their lowest, the rising water table that occurs in winter is often not taken into account. Some systems are not designed to be installed within the water table and are unable to withstand the hydrostatic pressures, resulting in their collapse. Rainstream Home XL has been designed by civil engineers to withstand these hydrostatic pressures. Further testing has taken place proving the tank's capability

to withstand water pressure at a burial depth of up to 6m or 0.6 bar, far beyond the pressures the tank is likely to face. The range of tank sizes offered by Polypipe has been researched and designed to meet the exact requirements of the UK market, based on research into the national average household water use and the most up-to-date MET office data. Rainstream Home XL tanks allow the homeowner to meet their exact requirements and therefore provide the most cost-effective and efficient solution in the market, without the need to over-specify and incur disproportionate purchasing and installation costs.

Manifold system for multiple dwellings

A manifold system can be a highly effective and economical way of capturing rainwater from multiple properties.

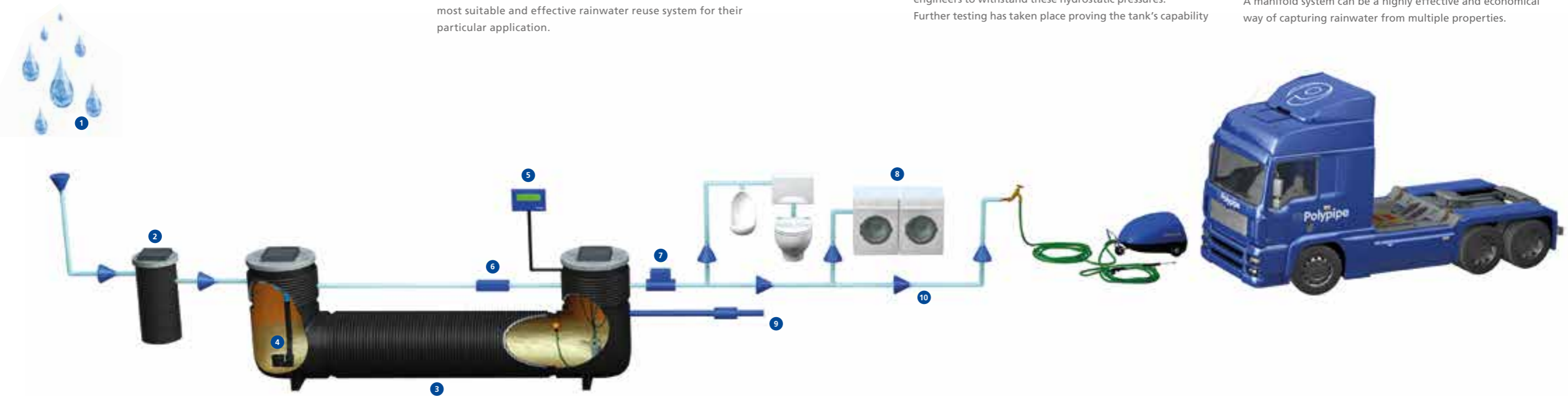

Typical system process

- 1** Rainwater falling onto roofs, roads and paved areas can be collected by a variety of measures which include guttering, channel drainage and specialised roof drain systems.
- 2** Pre-tank filtration then removes any larger pieces of debris such as leaves, before the collected water passes to the storage tank.
- 3** The storage vessel is typically a large tank which can sometimes be included within a building, surface mounted externally or buried below the surface of the site.
- 4** Captured water is redistributed through a second stage filtration and pump assembly.
- 5** A sophisticated control unit monitors water levels in various parts of the system and matches these to the water demand at the outlets.
- 6** Third stage in-line filtration to remove finer particles of debris before use.
- 7** An optional ultra violet disinfection process can be used to kill off bacteria and improve the quality of the collected water.
- 8** Water is supplied on demand to a number of outlets around the property and can be used for many different purposes including flushing toilets, watering gardens or cleaning vehicles.
- 9** A back flow prevention device stops a backward flow of contaminated water from the sewer and acts as a rodent barrier.
- 10** Outlet to the sewer, soakaway, attenuation, or for reuse purposes.

Land drainage overview

Excess water can lead to restricted land access, reduced crop yields, soil erosion and environmental damage, making effective drainage a critical component of any water management scheme.



Land drainage key benefits

- Full range of pipes and fittings in sizes from 60-200mm
- Kitemarked to BS 4962 (blue coil and couplers only)
- Blue as standard, also available in black
- Perforated and unperforated options available
- Flexible, durable and easy to install
- Extremely cost-effective
- Supported by a full range of fittings
- Manufactured from PVCu



Landcoil drainage systems

Our Landcoil range is specifically designed to aid in the successful management of land water. It offers significant improvements in areas where poor drainage negatively affects ground quality, from agricultural applications requiring enhanced soil conservation or crop production capabilities; to sports and leisure projects struggling with waterlogged sections of pitch or turf. Manufactured in one of the UK's largest dedicated manufacturing facilities, our PVCu Landcoil range includes a choice of diameters, colours and coil lengths. It is also durable, easy to install, carries the BS 4962 quality Kitemark and is supported by an extensive range of fittings.



Contents

| | | |
|------------------|------------------------|---------|
| SECTION 7 | Land drainage | |
| | Land drainage overview | 94 - 95 |
| | Landcoil system | 96 - 97 |

SECTION 7 Land drainage

www.polypipe.com/landdrainage

Landcoil system

Landcoil is a PVCu single walled flexible piping system, used for the successful management of land water. It is available perforated or unperforated in blue as standard, as a Kitemarked system and is also available in black.



Landcoil system key benefits

- Full range of pipes and fittings available in sizes 60-200mm
- Kitemarked to BS 4962 (blue coil and couplers only)
- Perforated and unperforated options available
- Flexible, durable and easy to install
- Extremely cost-effective
- Supported by a full range of fittings
- Available in yellow for gas applications (see page 127 for Gas Ducting)
- Available with a non-woven fabric geotextile wrap (see page 30 for Linflex Type 8 Narrow Filter Drain)



Landcoil end caps
Not suitable for air tests.



Landcoil multi-junctions

| Landcoil | | | | | | |
|-----------------|---------------------|-------|-------|----------|--------------|--------|
| Nominal size mm | Code | OD mm | ID mm | Length m | Description | Colour |
| 60 | LD6025 (B or BLK) | 60 | 50 | 25 | Perforated | B BLK* |
| 60 | LD6050 (B or BLK) | 60 | 50 | 50 | Perforated | B BLK* |
| 60 | LD60150 (B or BLK) | 60 | 50 | 150 | Perforated | B BLK* |
| 60 | UD60150 (B or BLK) | 60 | 50 | 150 | Unperforated | B BLK* |
| 80 | LD8025 (B or BLK) | 80 | 71 | 25 | Perforated | B BLK* |
| 80 | LD8050 (B or BLK) | 80 | 71 | 50 | Perforated | B BLK* |
| 80 | LD80100 (B or BLK) | 80 | 71 | 100 | Perforated | B BLK* |
| 80 | UD80100 (B or BLK) | 80 | 71 | 100 | Unperforated | B BLK* |
| 100 | LD10025 (B or BLK) | 100 | 90 | 25 | Perforated | B BLK* |
| 100 | LD10050 (B or BLK) | 100 | 90 | 50 | Perforated | B BLK* |
| 100 | LD100100 (B or BLK) | 100 | 90 | 100 | Perforated | B BLK* |
| 100 | UD100100 (B or BLK) | 100 | 90 | 100 | Unperforated | B BLK* |
| 160 | LD16025 (B or BLK) | 160 | 148 | 25 | Perforated | B BLK* |
| 160 | LD16045 (B or BLK) | 160 | 148 | 45 | Perforated | B BLK* |
| 160 | UD16045 (B or BLK) | 160 | 148 | 45 | Unperforated | B BLK* |
| 200 | LD20040 (B or BLK) | 200 | 183 | 40 | Perforated | B BLK* |
| 200 | UD20040 (B or BLK) | 200 | 183 | 40 | Unperforated | B BLK* |

*Black (BLK) is not a Kitemarked product.



| Landcoil End Caps | | |
|-------------------|--------|----------|
| Nominal size mm | Code | Pack qty |
| 60 | HEC60 | 10 |
| 80 | HEC80 | 10 |
| 100 | HEC100 | 10 |
| 160 | HEC160 | 10 |
| 200 | HEC200 | 10 |

| Landcoil Multi-Junctions | | | |
|--------------------------|---------|--------|----------|
| Nominal size mm | Code | Colour | Pack qty |
| 60 to 60 | CDJ66 | Blue | 100 |
| 80 to 100 | CDJ10M | Blue | 20 |
| 160 to 60 | CDJ160M | Black | 5 |

Outfall pipe subject to minimum order quantity.

| Landcoil Couplers | | | | | |
|-------------------|---------|-------|-----------|-------------------|----------|
| Nominal size mm | Code | OD mm | Length mm | Wall thickness mm | Pack qty |
| 60 | DC60 | 64 | 110 | 1.9 | 10 |
| 80 | DC80M* | 85 | 130 | 2.35 | 10 |
| 100 | DC100M* | 105 | 130 | 2.35 | 10 |
| 160 | DC160M* | 165 | 150 | 2.35 | 10 |
| 200 | DC200 | 205 | 165 | 2.4 | 10 |

*Made from polypropylene, other couplers are made from PVCu.
Note: Landcoil couplers can also be used with Linflex Fin & Narrow Filter Drains, please see Section 2 for further information.



For further information please see our Landcoil datasheet, which can be downloaded from our website toolbox www.polypipe.com/toolbox



Landcoil couplers

Couplers key benefits

- 3 lug design for greater integrity and fit of joint
- Ease of installation
- Ensures a secure joint
- Reduces the possibility of the coils pulling away from the coupler during the drainage process
- Kitemarked to BS 4962

SECTION 8 Sewer systems

www.polypipe.com/sewer

Sewer systems overview

We offer the largest range of thermoplastic structured walled sewer pipes from 150-3000mm, providing robust, chemical and sewer gas-resistant pipes for new and replacement gravity sewer systems. Both Polysewer and Ridgisewer give design engineers the widest possible product choice for the best possible solution.

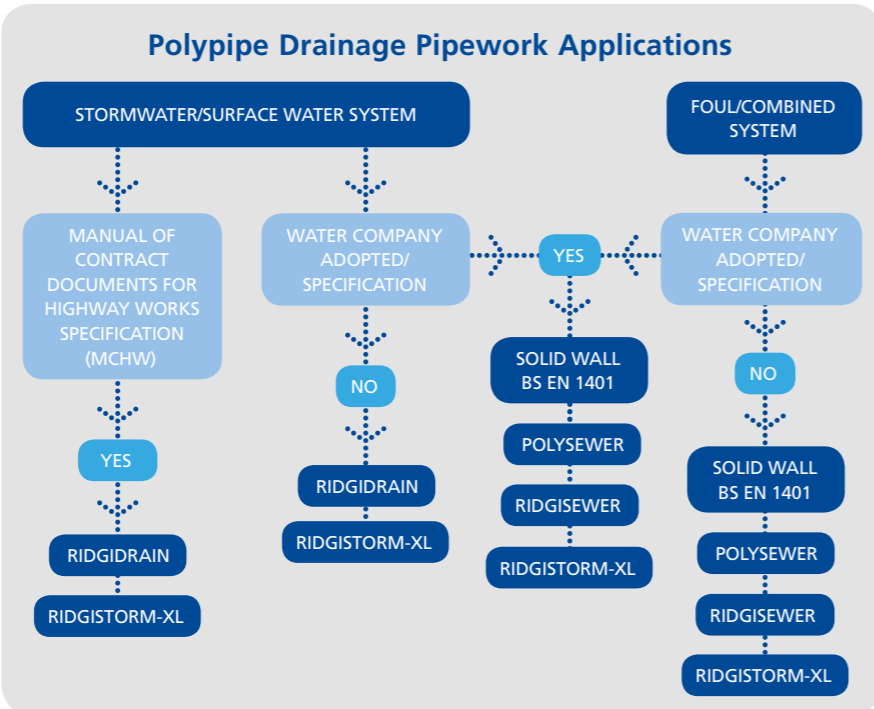

- ### Sewer systems key benefits
- Fully compliant with WIS 4-35-01
 - BBA approved
 - Lighter in weight for increased Health and Safety benefits
 - Durable, long life PVCu and polypropylene
 - Structured wall pipe for high ring stiffness and strength
 - Integral sockets for quicker installation and greater leak tightness
 - Strong, flexible pipe wall withstands ground movement and differential settlement
 - Chemical, impact and abrasion resistant
 - Resistant to sulphate attack and corrosion by sewer gas
 - Meets WRc Code of Practice for high pressure water jetting tolerance
 - Saddle connectors are available
 - Life expectancy in excess of 100 years



Sewer product range

With diameters ranging from 150-600mm* inclusive, our extensive range of 3m integrally socketed sewer pipes is designed to provide solutions for even the most difficult gravity sewer projects.

Polysewer is a range of PVCu structured wall pipes and fittings available in diameters from 150-300mm and is manufactured in accordance with BSI Kitemark Licence numbers KM55698 to WIS 4-35-01 and KM582885 to BS EN 13476. **Ridgisewer** is manufactured from polypropylene and features four sizes from 400-600mm and includes a complete system of couplings, seals, bends, junctions, specialist fabrications and saddles. Ridgisewer is manufactured in accordance with BSI Kitemark Licence number KM55701 to WIS 4-35-01.

*Sizes 750-3000mm are available as Ridgistorm-XL, please see [Section 3](#) for further information.



Contents

| SECTION 8 Sewer systems | |
|---|-----------|
| Sewer systems overview | 98 - 99 |
| Polysewer - pipes, fittings and accessories | 100 - 104 |
| Sewer Saddles and Ridgisewer pipe | 105 |
| Ridgisewer - fittings and accessories | 106 - 109 |

SECTION 8 Polysewer - Pipes, fittings and accessories

www.polypipe.com/sewer

Polysewer



Polysewer integrally socketed pipes
Each pipe supplied with 1 seal.

| Polysewer Integrally Socketed Pipes | | | | | |
|-------------------------------------|--------|-------|-------|----------|----------|
| Nominal size mm | Code | ID mm | OD mm | Length m | Pack qty |
| 150 | PS632 | 146 | 160 | 3 | 46 |
| 225 | PS1032 | 229 | 250 | 3 | 23 |
| 300 | PS1232 | 301 | 330 | 3 | 8 |

6m lengths available, subject to minimum order quantity and lead times.



Polysewer sealing rings

| Polysewer Sealing Rings | | |
|-------------------------|-------|----------|
| Nominal size mm | Code | Pack qty |
| 150 | PSSP1 | 10 |
| 225 | PSSP2 | 10 |
| 300 | PSSP3 | 10 |



Polysewer double socket couplings
Each coupler supplied with 2 seals.

| Polysewer Double Socket Couplings | | | | |
|-----------------------------------|--------|------|------|----------|
| Nominal size mm | Code | A mm | B mm | Pack qty |
| 150 | PS601 | 161 | 183 | 10 |
| 225 | PS1001 | 251 | 260 | 1 |
| 300 | PS1201 | 332 | 280 | 1 |



Polysewer double socket slip couplings
Each coupler supplied with 2 seals.

| Polysewer Double Socket Slip Couplings | | | | |
|--|----------|------|------|----------|
| Nominal size mm | Code | A mm | B mm | Pack qty |
| 150 | PS600 | 161 | 183 | 10 |
| 225 | PS1000 ▲ | 251 | 260 | 1 |
| 300 | PS1200 ▲ | 332 | 280 | 1 |

▲ Made to order and subject to lead times.

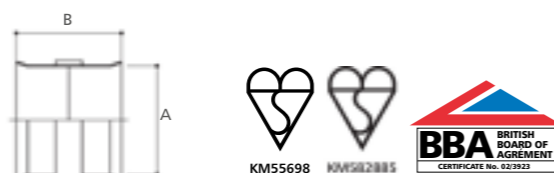

| Polysewer 15° Bends | | | | |
|---------------------|----------|-------|------|----------|
| Nominal size mm | Code | A mm | B mm | Pack qty |
| 150 | PS609 | 115 | 95 | 10 |
| 225 | PS1009 | 123.5 | 92.5 | 1 |
| 300 | PS1209 ▲ | 152 | 114 | 1 |

▲ Made to order and subject to lead times.



Polysewer 15° bends
Each bend supplied with 2 seals.

| Polysewer 30° Bends | | | | |
|---------------------|--------|-------|------|----------|
| Nominal size mm | Code | A mm | B mm | Pack qty |
| 150 | PS667 | 115 | 95 | 10 |
| 225 | PS1067 | 143.5 | 92.5 | 1 |
| 300 | PS1267 | 177 | 114 | 1 |



Polysewer 30° bends
Each bend supplied with 2 seals.

| Polysewer 45° Bends | | | | |
|---------------------|--------|-------|------|----------|
| Nominal size mm | Code | A mm | B mm | Pack qty |
| 150 | PS603 | 135 | 95 | 10 |
| 225 | PS1003 | 164.5 | 92.5 | 1 |
| 300 | PS1203 | 203 | 114 | 1 |

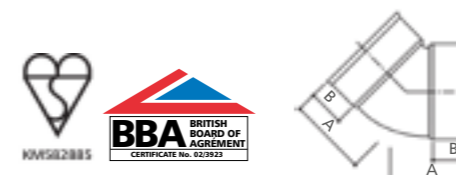

Polysewer 45° bends
Each bend supplied with 2 seals.

| Polysewer 90° Bends | | | | |
|---------------------|--------|-------|------|----------|
| Nominal size mm | Code | A mm | B mm | Pack qty |
| 150 | PS611 | 190 | 63 | 10 |
| 225 | PS1011 | 316.5 | 92.5 | 1 |
| 300 | PS1211 | 385 | 114 | 1 |

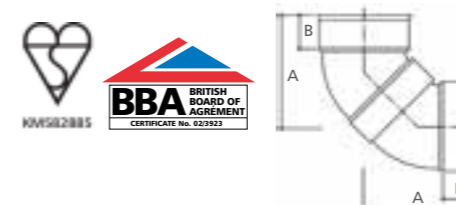

Polysewer 90° bends
Each bend supplied with 2 seals.

SECTION 8 Polysewer - Fittings and accessories

www.polypipe.com/sewer



Polysewer 45° equal junctions
Each junction supplied with 3 seals.

| Polysewer 45° Equal Junctions | | | | | | | |
|-------------------------------|------|------|------|------|------|------|----------|
| Code | A mm | B mm | C mm | D mm | E mm | F mm | Pack qty |
| PS605 | 161 | 150 | 285 | 445 | 95 | 95 | 5 |
| PS1005 | 251 | 225 | 408 | 647 | 92.5 | 92.5 | 1 |
| PS1205 | 332 | 300 | 508 | 812 | 114 | 114 | 1 |

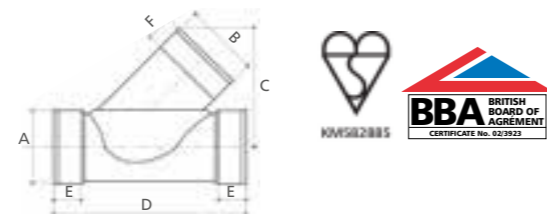

Polysewer 45° unequal junctions
Each junction supplied with 3 seals.

| Polysewer 45° Unequal Junctions | | | | | | | |
|---------------------------------|------|------|-------|------|------|------|----------|
| Code | A mm | B mm | C mm | D mm | E mm | F mm | Pack qty |
| PS635RS | 161 | 110 | 242.5 | 400 | 62 | 57 | 5 |
| PS1035RS | 251 | 110 | 280.5 | 517 | 92.5 | 67.5 | 1 |
| PS1031 | 251 | 150 | 324 | 537 | 92.5 | 82.5 | 1 |
| PS1031RS | 251 | 160 | 328 | 567 | 92.5 | 82.5 | 1 |
| PS1235RS | 300 | 110 | 311 | 523 | 114 | 67.5 | 1 |
| PS1231 | 300 | 150 | 348 | 586 | 114 | 82.5 | 1 |
| PS1231RS | 300 | 160 | 356 | 573 | 114 | 82.5 | 1 |
| PS12100 | 300 | 225 | 458 | 704 | 114 | 100 | 1 |

Note: 110mm & 160mm sockets are for connection to EN 1401-1 solid wall pipes. 150mm, 225mm & 300mm sockets are for connection to Polysewer structured wall pipes.

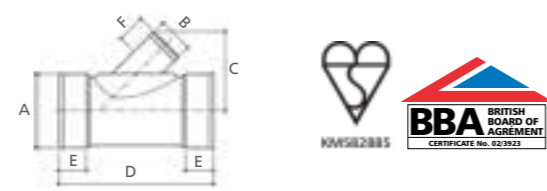

Polysewer 90° equal junctions
Each junction supplied with 3 seals.

| Polysewer 90° Equal Junctions | | | | | | | |
|-------------------------------|------|------|------|------|------|------|----------|
| Code | A mm | B mm | C mm | D mm | E mm | F mm | Pack qty |
| PS623 | 150 | 150 | 186 | 400 | 69 | 69 | 5 |

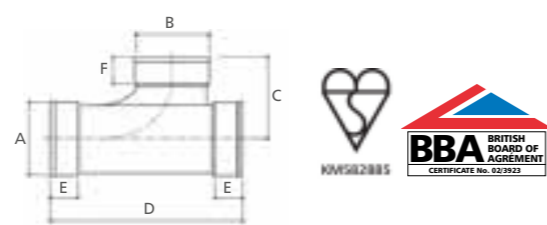

| Polysewer 90° Unequal Junctions | | | | | | | |
|---------------------------------|------|------|------|------|------|------|----------|
| Code | A mm | B mm | C mm | D mm | E mm | F mm | Pack qty |
| PS643RS | 150 | 110 | 182 | 301 | 69 | 65 | 5 |

Note: 110mm & 160mm sockets are for connection to EN 1401-1 solid wall pipes. 150mm, 225mm & 300mm sockets are for connection to Polysewer structured wall pipes.

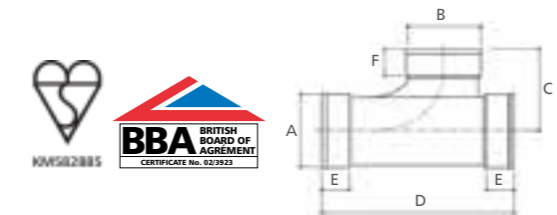

Polysewer 90° unequal junctions
Each junction supplied with 3 seals.

| Polysewer End Caps | | | | |
|--------------------|---------|------|------|----------|
| Nominal size mm | Code | A mm | B mm | Pack qty |
| 150 | PS6101 | 150 | 36 | 10 |
| 225 | PS10101 | 225 | 98 | 1 |
| 300 | PS12101 | 300 | 121 | 1 |



Polysewer end caps
Each end cap supplied with 1 seal.

| Polysewer Socket Plugs | | | | | | |
|------------------------|--------|------|------|------|------|----------|
| Nominal size mm | Code | A mm | B mm | C mm | D mm | Pack qty |
| 150 | PS620 | 215 | 178 | 85 | 76 | 10 |
| 225 | PS1020 | 308 | 248 | 101 | 92 | 1 |
| 300 | PS1220 | 395 | 329 | 110 | 101 | 1 |

Dimension C is the overall length of the fitting. Dimension D is the length of the spigot that pushes inside a socket. (i.e. D = C minus the thickness of the material that is the flange.)



Polysewer socket plugs
Each socket plug supplied with 1 seal.

| Polysewer Snap Caps & Seals | | | |
|-----------------------------|--------|---|----------|
| Nominal size mm | Code | Description | Pack qty |
| 150 | PS6103 | To adapt 87.5° bends and 45° unequal junctions to EN 1401 pipes | 10 |
| 150 | PS6104 | To adapt 87.5° junctions to EN 1401 pipes | 10 |



Polysewer snap caps and seals

| Polysewer Rodding Eye | | | |
|-----------------------|--------|------------------------------|----------|
| Nominal size mm | Code | Description | Pack qty |
| 150 | PS622S | Sealed oval top in aluminium | 8 |



Polysewer rodding eye

SECTION 8 Polysewer - Accessories



Polysewer spigot adaptors to EN 1401-1
Each adaptor supplied with 1 seal.

| Polysewer Spigot Adaptors to EN 1401-1 | | | | | | |
|--|---------|------|------|------|------|------|
| Nominal size mm | Code | A mm | B mm | C mm | D mm | E mm |
| 225 | PS10102 | 250 | 251 | 241 | 134 | 92.5 |
| 300 | PS12102 | 315 | 332 | 265 | 144 | 114 |

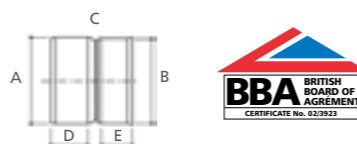

Polysewer socket adaptors to EN 1401-1
Each adaptor supplied with 2 seals.

| Polysewer Socket Adaptors to EN 1401-1 | | | | | | | |
|--|--------|------|------|------|------|------|----------|
| Nominal size mm | Code | A mm | B mm | C mm | D mm | E mm | Pack qty |
| 150 | PS689 | 160 | 161 | 147 | 70 | 77 | 10 |
| 225 | PS1089 | 250 | 251 | 240 | 110 | 92.5 | 1 |
| 300 | PS1289 | 315 | 332 | 286 | 125 | 114 | 1 |

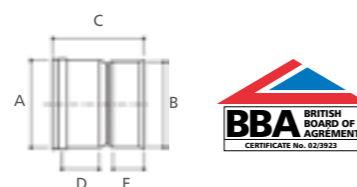

Polysewer level invert reducers
Each adaptor supplied with 2 seals.

| Polysewer Level Invert Reducers | | | | | | | |
|---------------------------------|--------|------|------|------|------|------|----------|
| Nominal size mm | Code | A mm | B mm | C mm | D mm | E mm | Pack qty |
| 225 x 150 | PS1021 | 225 | 150 | 287 | 92.5 | 72.5 | 1 |
| 300 x 225 | PS1221 | 300 | 220 | 345 | 114 | 92.5 | 1 |

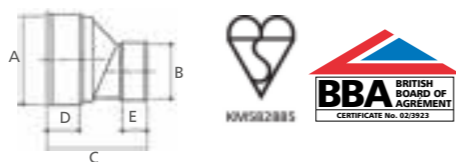

Polysewer adaptors to other pipe systems
Each adaptor supplied with seals.

| Polysewer Adaptors to other Pipe Systems | | | |
|--|---------|--------------------------------------|----------|
| Nominal size mm | Code | Description | Pack qty |
| 150 | PS634 | Double socket to super clayware pipe | 10 |
| 150 | PS696 | Double socket to thick clayware pipe | 10 |
| 150 | PS6105 | Double socket Ultrarib adaptor | 10 |
| 225 | PS10105 | Double socket Ultrarib adaptor | 10 |
| 300 | PS12105 | Double socket Ultrarib adaptor | 10 |

Note: For adaption to 225mm and 300mm clay pipe, flexible couplings to WIS 4-41-01 should be used.



Sewer Saddles and Ridgisewer pipes

Sewer Saddles

The range of saddles for Polysewer and Ridgisewer structured wall plastic pipes allows the leak-tight and secure connection of 160mm EN1401-1 underground drainage pipe. They are suitable for both new installations and for post connection into existing pipelines.

Sewer Saddles key benefits

- Designed specifically to seal onto structured wall plastic sewer pipes
- Durable watertight joint tested to 0.5 bar hydrostatic pressure and -0.3 bar vacuum
- Prohibits protrusion of lateral pipe into the main drain or sewer
- Can be connected to smaller pipes and to laterals of different materials using adaptors
- Environmentally friendly as all elements are recyclable
- Elastomeric seal ensures reliable flexible watertight joint between lateral and main drain/sewer
- Reduces disruption and risk of damage to the sewer as there is no need to fully excavate around the pipe



| Sewer Saddles | | | |
|-----------------|-------------------|-----------|----------|
| Nominal size mm | Description | Code | Pack qty |
| 300 | Polysewer Saddle | SLDP5300 | 10 |
| 400 & 450 | Ridgisewer Saddle | SLD375450 | 10 |
| 500 | Ridgisewer Saddle | SLD500 | 10 |
| 600 | Ridgisewer Saddle | SLD600 | 10 |
| - | 177mm Hole Saw | HOL177 | 1 |

Ridgisewer

| Ridgisewer Integrally Socketed pipes | | | | | | |
|--------------------------------------|---------------|-------|-------|-----------|-------------|----------|
| Nominal size mm | Code | ID mm | OD mm | Length mm | Weight kg/m | Pack qty |
| 400 | RSW400X3IS4 | 400 | 457 | 3 | 9.4 | 5 |
| 450 | RSW450X3IS4 | 450 | 511 | 3 | 11.8 | 4 |
| 500 | RSW500X3IS4/1 | 500 | 568 | 3 | 13.3 | 1 |
| 600 | RSW600X3IS4 | 587 | 672 | 3 | 15.3 | 1 |

6m lengths available on request, subject to minimum order quantity. Sizes 750 - 3000mm are available as Ridgistorm-XL, please see Section 3 for further information.



Ridgisewer integrally socketed pipe
Order seals separately for the Ridgisewer range.

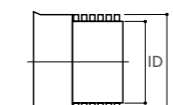

SECTION 8 Ridgisewer - Fittings and accessories

www.polypipe.com/sewer



Ridgisewer sealing rings

Ridgisewer Nitrile Sealing Rings

| Nominal size mm | Code | Pack qty |
|-----------------|--------------|----------|
| 400 | SRSW400NIT ▲ | 2 |
| 450 | SRSW450NIT ▲ | 2 |
| 500 | SRSW500NIT ▲ | 2 |
| 600 | SRSW600NIT ▲ | 2 |

▲ Made to order and are subject to lead times. Typically used where soil contains certain chemicals. Please send soil reports to our Technical Team.

Ridgisewer Sealing Rings

| Nominal size mm | Code | Pack qty |
|-----------------|---------|----------|
| 400 | SRSW400 | 2 |
| 450 | SRSW450 | 2 |
| 500 | SRSW500 | 2 |
| 600 | SRSW600 | 2 |

Seals are EPDM to EN681 Part 1 as standard.



Ridgisewer double socket couplings

Order seals separately.

Ridgisewer Double Socket Couplings

| Nominal size mm | Code | A mm | B mm | Pack qty |
|-----------------|-----------|------|------|----------|
| 400 | RSWC400 | 410 | 490 | 1 |
| 450 | RSWC450 | 440 | 548 | 1 |
| 500 | RSWC500/1 | 490 | 605 | 1 |
| 600 | RSWC600 | 560 | 713 | 1 |



Ridgisewer double socket slip couplings

Order seals separately.

Ridgisewer Double Socket Slip Couplings

| Nominal size mm | Code | A mm | B mm | Pack qty |
|-----------------|------------|------|------|----------|
| 400 | RSWSC400 | 392 | 490 | 1 |
| 450 | RSWSC450 | 420 | 548 | 1 |
| 500 | RSWSC500/1 | 470 | 605 | 1 |
| 600 | RSWSC600 | 540 | 713 | 1 |



Ridgisewer end caps

Order seals separately if required.

Ridgisewer End Caps

| Nominal size mm | Code | Pack qty |
|-----------------|------------|----------|
| 400 | RSWEC400 | 1 |
| 450 | RSWEC450 | 1 |
| 500 | RSWEC500/1 | 1 |
| 600 | RSWEC600 | 1 |



Ridgisewer 11.25° Bends

| Nominal size mm | Code | A mm | B mm | Pack qty |
|-----------------|----------------|------|------|----------|
| 400 | RSWB40011.25 | 375 | 205 | 1 |
| 450 | RSWB45011.25 | 415 | 220 | 1 |
| 500 | RSWB50011.25/1 | 490 | 245 | 1 |
| 600 | RSWB60011.25 | 535 | 280 | 1 |

Sizes 750mm and above are available as Ridgiform-XL. Some bends are made to order and subject to lead times.

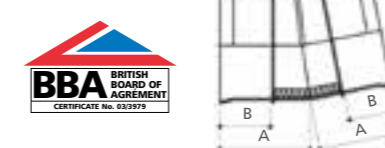

Ridgisewer 11.25° bends

Order seals separately if required.

Ridgisewer 22.5° Bends

| Nominal size mm | Code | A mm | B mm | Pack qty |
|-----------------|---------------|------|------|----------|
| 400 | RSWB40022.5 | 375 | 205 | 1 |
| 450 | RSWB45022.5 | 415 | 220 | 1 |
| 500 | RSWB50022.5/1 | 490 | 245 | 1 |
| 600 | RSWB60022.5 | 535 | 280 | 1 |

Sizes 750mm and above are available as Ridgiform-XL. Some bends are made to order and subject to lead times.

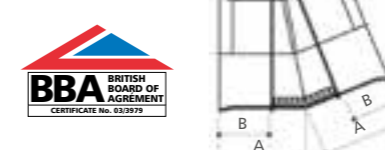

Ridgisewer 22.5° bends

Order seals separately if required.

Ridgisewer 45° Bends

| Nominal size mm | Code | A mm | B mm | Pack qty |
|-----------------|---------------|------|------|----------|
| 400 | RSWB40045 | 375 | 205 | 1 |
| 450 | RSWB45045 | 415 | 220 | 1 |
| 500 | RSWB50045/1 ▲ | 490 | 245 | 1 |
| 600 | RSWB60045 ▲ | 535 | 280 | 1 |

Sizes 750mm and above are available as Ridgiform-XL. ▲ Made to order and are subject to lead times.

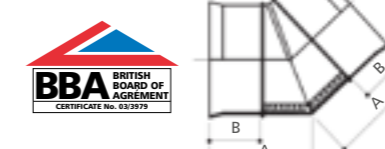

Ridgisewer 45° bends

Order seals separately if required.

Ridgisewer 90° Bends

| Nominal size mm | Code | A mm | B mm | C mm | Pack qty |
|-----------------|---------------|------|------|------|----------|
| 400 | RSWB40090 | 411 | 196 | 646 | 1 |
| 450 | RSWB45090 | 441 | 215 | 667 | 1 |
| 500 | RSWB50090/1 ▲ | 488 | 250 | 687 | 1 |
| 600 | RSWB60090 ▲ | 533 | 275 | 728 | 1 |

Sizes 750mm and above are available as Ridgiform-XL. ▲ Made to order and are subject to lead times.

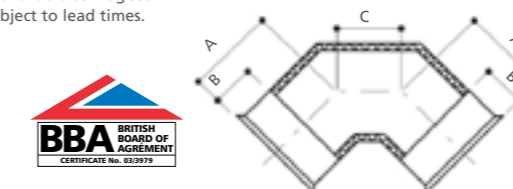

Ridgisewer 90° bends

Order seals separately if required.

SECTION 8 Ridgisewer - Fittings

www.polypipe.com/sewer



Ridgisewer 45° equal junctions

Order seals separately if required.

| Ridgisewer 45° Equal Junctions | | | | | | | |
|--------------------------------|------|--------------|------|------|------|------|----------|
| Nominal size | | Code | C mm | D mm | E mm | F mm | Pack qty |
| A mm | B mm | | | | | | |
| 400 | 400 | RSWEJ400Y▲ | 1000 | 1737 | 205 | 205 | 1 |
| 450 | 450 | RSWEJ450Y▲ | 1050 | 1780 | 220 | 220 | 1 |
| 500 | 500 | RSWEJ500Y/1▲ | 1100 | 1930 | 245 | 245 | 1 |
| 600 | 600 | RSWEJ600Y▲ | 1309 | 2175 | 280 | 280 | 1 |

▲ Made to order and subject to lead times.
Sizes 750mm and above are available as Ridgistorm-XL, please see Section 3 for further information.

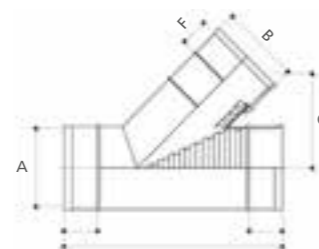

| Ridgisewer 90° Equal Junctions | | | | | | | |
|--------------------------------|------|-------------|------|------|------|------|----------|
| Nominal size | | Code | C mm | D mm | E mm | F mm | Pack qty |
| A mm | B mm | | | | | | |
| 400 | 400 | RSWEJ400T | 700 | 1380 | 205 | 205 | 1 |
| 450 | 450 | RSWEJ450T | 805 | 1700 | 220 | 220 | 1 |
| 500 | 500 | RSWEJ500T/1 | 850 | 1792 | 245 | 245 | 1 |
| 600 | 600 | RSWEJ600T | 1350 | 1975 | 280 | 280 | 1 |

Sizes 750mm and above are available as Ridgistorm-XL, please see section 3 for further information.

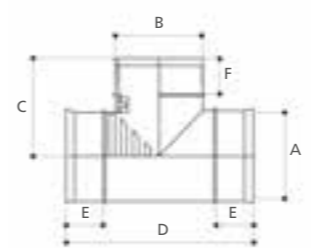

Ridgisewer 90° equal junctions

Order seals separately if required.



Ridgisewer 45° unequal junctions

110 & 160mm branches are for EN1401 pipes. 150mm branches are for Polysewer.
Order seals separately if required.

| Ridgisewer 45° Unequal Junctions | | | | | | | |
|----------------------------------|------|-----------------|------|------|------|------|----------|
| Nominal size | | Code | C mm | D mm | E mm | F mm | Pack qty |
| A mm | B mm | | | | | | |
| 400 | 110 | RSWJ400110Y▲ | 395 | 750 | 196 | 46 | 1 |
| 400 | 150 | RSWPSJ400150Y | 435 | 750 | 196 | 51 | 1 |
| 400 | 160 | RSWJ400160Y | 435 | 750 | 196 | 51 | 1 |
| 450 | 110 | RSWJ450110Y▲ | 422 | 815 | 215 | 46 | 1 |
| 450 | 150 | RSWPSJ450150Y | 462 | 815 | 215 | 51 | 1 |
| 450 | 160 | RSWJ450160Y | 462 | 815 | 215 | 51 | 1 |
| 500 | 110 | RSWJ500110Y/1▲ | 450 | 920 | 240 | 46 | 1 |
| 500 | 150 | RSWPSJ500150Y/1 | 490 | 920 | 240 | 51 | 1 |
| 500 | 160 | RSWJ500160Y/1 | 490 | 920 | 240 | 51 | 1 |
| 600 | 110 | RSWJ600110Y▲ | 503 | 1060 | 275 | 46 | 1 |
| 600 | 150 | RSWPSJ600150Y | 543 | 1060 | 275 | 51 | 1 |
| 600 | 160 | RSWJ600160Y | 543 | 1060 | 275 | 51 | 1 |

▲ Made to order and subject to lead times.
Sizes 750mm and above are available as Ridgistorm-XL, please see section 3 for further information.
Note: 110mm and 160mm sockets are for connection to Polysewer structured wall pipes.

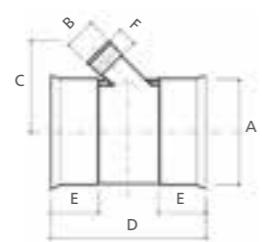

| Ridgisewer 90° Unequal Junctions | | | | | | | |
|----------------------------------|------|-----------------|------|------|------|------|----------|
| Nominal size | | Code | C mm | D mm | E mm | F mm | Pack qty |
| A mm | B mm | | | | | | |
| 400 | 110 | RSWJ400110T | 360 | 750 | 196 | 46 | 1 |
| 400 | 150 | RSWPSJ400150T | 375 | 750 | 196 | 51 | 1 |
| 400 | 160 | RSWJ400160T | 375 | 750 | 196 | 51 | 1 |
| 450 | 110 | RSWJ450110T▲ | 385 | 815 | 215 | 46 | 1 |
| 450 | 150 | RSWPSJ450150T | 400 | 815 | 215 | 51 | 1 |
| 450 | 160 | RSWJ450160T | 400 | 815 | 215 | 51 | 1 |
| 500 | 110 | RSWJ500110T/1▲ | 415 | 920 | 240 | 46 | 1 |
| 500 | 150 | RSWPSJ500150T/1 | 430 | 920 | 240 | 51 | 1 |
| 500 | 160 | RSWJ500160T/1 | 430 | 920 | 240 | 51 | 1 |
| 600 | 110 | RSWJ600110T | 465 | 1060 | 275 | 46 | 1 |
| 600 | 150 | RSWPSJ600150T | 480 | 1060 | 275 | 51 | 1 |
| 600 | 160 | RSWJ600160T | 480 | 1060 | 275 | 51 | 1 |

▲ Made to order and subject to lead times.
Sizes 750mm and above are available as Ridgistorm-XL, please see section 3 for further information.
Note: 110mm and 160mm sockets are for connection to Polysewer structured wall pipes.

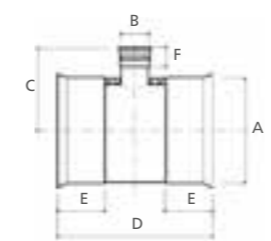

Ridgisewer 90° unequal junctions

110 & 160mm branches are for EN1401 pipes. 150mm branches are for Polysewer.
Order seals separately if required.

Cable protection overview

Our cable protection range of products has been used extensively for rail, highways, housing developments, commercial, retail and industrial infrastructure applications.

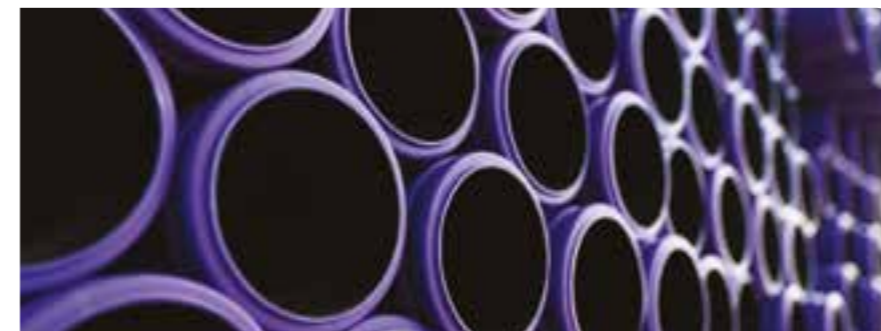

Applications

We offer a full range of cable protection systems for:

- Power
- Motorway Communications
- Lighting
- Utilities
 - Gas
 - Water
 - Telecommunications
 - Traffic signalling
 - Cable television
 - PVCu specification

Cable protection range

Reflecting our expertise in protecting crucial power, lighting and communications cabling, our UK-manufactured range of pipes are certified to British and European standards and conform to industry standards such as ENATS 12-24, the Electrical Supply Industry Specification for Cable Protection. With over 1,000 tried and tested products to choose from, we provide the largest range of cable protection systems for almost any application.



(Network Rail Parts and Drawing Systems (PADS) Approved).
 Certificate number: PA05/05875
 Approved Ridgiduct and Ridgicoil can be used in conjunction with Under Track Crossing (UTX) chambers, manufactured from Ridgistorm-XL.

Contents

| SECTION 9 | Cable protection | |
|-----------|---------------------------------------|-----------|
| | Cable protection overview | 110 - 111 |
| | Power - Class 1 | 112 - 113 |
| | Power - Class 2 | 114 |
| | Power - Class 3 | 115 |
| | Ridgicoil power and power accessories | 116 - 117 |
| | General purpose power | 118 - 119 |
| | Motorway communications | 120 - 121 |
| | Lighting | 122 - 125 |
| | Utilities | 126 - 129 |
| | Installation advice | 130 - 131 |

Power

Polypipe is the UK's leading supplier to the power and utilities industry and is an approved manufacturer for many Distribution Network Operator (DNO) companies. Our products include cable protection that complies with ENATS 12-24 Classes 1, 2 and 3, as well as above ground solutions such as cable guards and hockey sticks.

Power - Class 1

Ridgiduct Power HV

Manufactured from polypropylene, Ridgiduct Power HV offers a stiff yet flexible twinwall structured cable protection system, which complies fully with ENATS 12-24 Class 1 specification. It is available in black outer and red inner as standard, but can also be manufactured with a red outer and red inner.



| Ridgiduct Power HV Duct | | | | | |
|-------------------------|-------|----------|---------|---------------------|----------|
| ID mm | OD mm | Length m | Colours | Code | Pack qty |
| 100 | 118 | 2 | B R | RBHV100X2 (B or R)▲ | 85 |
| 100 | 118 | 3 | B R | RBHV100X3 (B or R)▲ | 85 |
| 100 | 118 | 6 | B R | RBHV100X6 (B or R) | 85 |
| 125 | 148 | 2 | B R | RBHV125X2 (B or R)▲ | 46 |
| 125 | 148 | 3 | B R | RBHV125X3 (B or R)▲ | 46 |
| 125 | 148 | 6 | B R | RBHV125X6 (B or R) | 46 |
| 150 | 178 | 2 | B R | RBHV150X2 (B or R)▲ | 36 |
| 150 | 178 | 3 | B R | RBHV150X3 (B or R)▲ | 36 |
| 150 | 178 | 6 | B R | RBHV150X6 (B or R) | 36 |

Available in black (B) or red (R). Please specify with order.
 ▲ Red (R) and black (B) are both made to order and subject to lead times.
 Note: Not a sealed system. Where a sealed system is required, our PVCu Power HV Duct with sealed joints tested to BS EN 1277, should be considered. See page 113 for further information.

| Ridgiduct Power HV Double Socket Bends | | | | | |
|--|---------------|--------|---------|---------------------------|----------|
| Nominal size mm | Bend radius m | Angle | Colours | Code | Pack qty |
| 100 | 3.9 | 11.25° | B R | RBHVB100X11X3.9 (B or R)▲ | 1 |
| 100 | 3.9 | 22.5° | B R | RBHVB100X22X3.9 (B or R)▲ | 1 |
| 100 | 1.2 | 45° | B R | RBHVB100X45X1.2 (B or R)▲ | 1 |
| 100 | 1.2 | 90° | B R | RBHVB100X90X1.2 (B or R)▲ | 1 |
| 125 | 3.9 | 11.25° | B R | RBHVB125X11X3.9 (B or R)▲ | 1 |
| 125 | 3.9 | 22.5° | B R | RBHVB125X22X3.9 (B or R)▲ | 1 |
| 125 | 1.2 | 45° | B R | RBHVB125X45X1.2 (B or R)▲ | 1 |
| 125 | 1.2 | 90° | B R | RBHVB125X90X1.2 (B or R)▲ | 1 |
| 150 | 3.9 | 11.25° | B R | RBHVB150X11X3.9 (B or R)▲ | 1 |
| 150 | 3.9 | 22.5° | B R | RBHVB150X22X3.9 (B or R)▲ | 1 |
| 150 | 1.2 | 45° | B R | RBHVB150X45X1.2 (B or R)▲ | 1 |
| 150 | 1.2 | 90° | B R | RBHVB150X90X1.2 (B or R)▲ | 1 |

Available in black (B) or red (R). Please specify with order.
 ▲ Red (R) is made to order and subject to lead times.



Ridgiduct Power HV bend

| Ridgiduct Coupling | | |
|--------------------|--------|----------|
| ID mm | Code | Pack qty |
| 100 | RBC100 | 10 |
| 125 | RBC125 | 10 |
| 150 | RBC150 | 10 |



ENATS (12-24)

Ridgiduct coupling

Trefoil Clip

Suitable for use with both Ridgiduct Power HV duct lengths and bends, the polypropylene Trefoil Clip is designed to support duct arrangement during installation and burial, ensuring consistent spacing of duct lengths and bends.

| Ridgiduct Power HV Trefoil Clip | | | |
|---------------------------------|--------|---------|----------|
| Diameter mm | Colour | Code | Pack qty |
| 100 | B | RBTC100 | 10 |
| 125 | B | RBTC125 | 10 |
| 150 | B | RBTC150 | 10 |



Trefoil Clip

PVCu Power HV

PVCu Power HV is a single wall cable protection system which fully complies with ENATS 12-24 Class 1 specification. Available for both unsealed and sealed systems, with sealed joints tested to BS EN 1277, it is suitable for high, medium and low voltage applications. It is available in black as standard, but can also be manufactured in red.

| PVCu Power HV Duct | | | | | | |
|---------------------------|-------|-------|----------|--------|-------------------------|----------|
| Nominal wall thickness mm | ID mm | OD mm | Length m | Colour | Code | Pack qty |
| UNSEALED | | | | | | |
| 4.1 | 102 | 110 | 6 | B | SD7110X6BNS | 95 |
| 5.2 | 150 | 160 | 6 | B | SD7160X6BNS | 46 |
| 4.1 | 102 | 110 | 6 | R | SD7110X6RNS | 95 |
| 5.2 | 150 | 160 | 6 | R | SD7160X6RNS | 46 |
| SEALED | | | | | | |
| 4.1 | 102 | 110 | 6 | B | SD7110X6BSPE▲ & UG402B▲ | 95 |
| 5.2 | 150 | 160 | 6 | B | SD7160X6BSPE▲ & UG602B▲ | 46 |
| 4.1 | 102 | 110 | 6 | R | SD7110X6RSPE▲ & UG402B▲ | 95 |
| 5.2 | 150 | 160 | 6 | R | SD7160X6RSPE▲ & UG602B▲ | 46 |

▲ Made to order and subject to lead times. Please order duct and coupling together to make a sealed system.

| PVCu Power HV Bends | | | | | |
|---------------------|---------------|--------|---------|---------------------------|----------|
| Nominal size mm | Bend radius m | Angle | Colours | Code | Pack qty |
| 110 | 3.9 | 11.25° | B R | SDB7110X11X3.9 (B or R)▲* | 1 |
| 110 | 3.9 | 22.5° | B R | SDB7110X22X3.9 (B or R)▲* | 1 |
| 110 | 1.2 | 45° | B R | SDB7110X45X1.2 (B or R)▲* | 1 |
| 110 | 1.2 | 90° | B R | SDB7110X90X1.2 (B or R)▲* | 1 |
| 160 | 3.9 | 11.25° | B R | SDB7160X11X3.9 (B or R)▲* | 1 |
| 160 | 3.9 | 22.5° | B R | SDB7160X22X3.9 (B or R)▲* | 1 |
| 160 | 1.2 | 45° | B R | SDB7160X45X1.2 (B or R)▲* | 1 |
| 160 | 1.2 | 90° | B R | SDB7160X90X1.2 (B or R)▲* | 1 |

Available in black (B) or red (R). Please specify with order.
 ▲ Red (R) is made to order and subject to lead times. *For sealed bends, please add the prefix 'S' to the end of the code. Bends for a sealed system are plain ended and bends for an unsealed system are single socketed.



ENATS (12-24)

PVCu Power HV Duct

PVCu Power HV key benefits

- Complies with ENATS 12-24 Class 1 specification, 450N compressive strength at 75°C
- Complies with BS EN 61386-24:2010, Type 750N, normal duty impact resistance
- IP47 rated system (watertight up to 1 metre) for sealed systems, otherwise IP4X
- 6m lengths as standard (other lengths available on request)
- Standard markings - Electrical Cable Duct (other markings available on request)

ENATS (12-24)



PVCu Power HV bend

All dimensions provided are nominal.

Power - Class 2

Ridgiduct Power

Ridgiduct is a twinwall system, specifically engineered to provide a light, yet robust solution for cable protection. Ridgiduct is manufactured from high density polyethylene (HDPE) and the resulting stiff, yet flexible, twinwall structure easily outperforms alternative products.

Ridgiduct Power key benefits

- Complies with ENATS 12-24 Class 2 specification 450N compressive strength at 50°C
- Complies with BS EN 61386-24:2010, Type 750N, normal duty impact resistance
- A preferred choice for many distribution network operator (DNO) companies
- Network Rail PADS approved
- Supplied with an integral coupler
- IP4X system (dust protection)
- Low weight, flexible, durable and high strength
- Good impact resistance, even at low temperatures
- Available in an alternative twinwall split duct form for easy installation around existing cables with minimal change in strength



Ridgiduct bend



Ridgiduct coupling

ENATS
(12-24)



ENATS
(12-24)

Network Rail
PA05/05875

Ridgiduct Power Duct

| ID mm | OD mm | Length m | Code | Pack qty |
|-------|-------|----------|--------------|----------|
| 100 | 118 | 2 | RB100X2* | 85 |
| 100 | 118 | 3 | RB100X3* | 85 |
| 100 | 118 | 6 | RB100X6* | 85 |
| 125 | 148 | 2 | RB125X2 | 46 |
| 125 | 148 | 3 | RB125X3 | 46 |
| 125 | 148 | 6 | RB125X6 | 46 |
| 150 | 178 | 2 | RB150X2* | 36 |
| 150 | 178 | 3 | RB150X3* | 36 |
| 150 | 178 | 6 | RB150X6* | 36 |
| 225 | 267 | 6 | RB225X6PE ▲* | 14 |
| 300 | 354 | 6 | RB300X6PE ▲* | 9 |

▲ Made to order and subject to lead times. Supplied plain ended, please order couplers and seals separately. *A sealed system can be achieved using Ridgidrain sealing rings and/or couplers, please see page 23.

Ridgiduct Double Socket Bends

| Nominal size mm | Bend radius m | Angle | Code | Pack qty |
|-----------------|---------------|--------|-----------------|----------|
| 100 | 2.4 | 11.25° | RBB100X11X2.4* | 1 |
| 100 | 2.4 | 22.5° | RBB100X22X2.4* | 1 |
| 100 | 0.45 | 45° | RBB100X45X0.45* | 1 |
| 100 | 0.45 | 90° | RBB100X90X0.45* | 1 |
| 125 | 2.4 | 11.25° | RBB125X11X2.4 | 1 |
| 125 | 2.4 | 22.5° | RBB125X22X2.4 | 1 |
| 125 | 0.61 | 45° | RBB125X45X0.61* | 1 |
| 125 | 0.61 | 90° | RBB125X90X0.61* | 1 |
| 150 | 2.4 | 11.25° | RBB150X11X2.4 | 1 |
| 150 | 2.4 | 22.5° | RBB150X22X2.4 | 1 |
| 150 | 0.61 | 45° | RBB150X45X0.61* | 1 |
| 150 | 0.61 | 90° | RBB150X90X0.61* | 1 |

Sealed Ridgiduct bends are available for 100 & 150mm duct.

*Bend radius compliant with ENATS 12-24.

Manufactured from PVCu.

Ridgiduct Coupling

| ID mm | Code | Pack qty |
|-------|---------|----------|
| 100 | RBC100 | 10 |
| 125 | RBC125 | 10 |
| 150 | RBC150 | 10 |
| 225 | CRD225* | 7 |
| 300 | CRD300* | 3 |

*225mm and 300mm couplers are from the Ridgidrain range.

Note: If the system is required to be watertight, then couplers will be required from the Ridgidrain range. For single socket fixed bellmouths and end caps, please see page 127.

Power - Class 3

Polyduct Power

Polyduct Power is manufactured from medium density polyethylene (MDPE) and is an ENATS 12-24 Class 3 specification product, available in coiled lengths. It has exceptional durability and can be used for either open trench or trenchless applications.



ENATS
(12-24)

Polyduct Power

Polyduct Power Duct

| ID mm | OD mm | Length m | Code | Pack qty |
|-------|-------|----------|----------------|----------|
| 32 | 37 | 25 | PD3237X25BEPE | 1 |
| 32 | 37 | 50 | PD3237X50BEPE | 1 |
| 32 | 37 | 100 | PD3237X100BEPE | 1 |
| 38 | 44 | 25 | PD3844X25BEPE | 1 |
| 38 | 44 | 50 | PD3844X50BEPE | 1 |
| 38 | 44 | 100 | PD3844X100BEPE | 1 |
| 50 | 60 | 25 | PD5060X25BEPE | 1 |
| 50 | 60 | 50 | PD5060X50BEPE | 1 |

Polyduct Power key benefits

- Complies with ENATS 12-24 Class 3, 450N compressive strength at 23°C
- Complies with BS EN 61386-24:2010, Type 450N, normal duty impact resistance
- Available in 25m, 50m or 100m coils plain ended
- Flexibility of coil eliminates the needs for specialised bends
- High impact resistance

Polyduct Black Couplings

| ID mm | OD mm | Code | Pack qty |
|-------|-------|-------|----------|
| 32 | 37 | PDC32 | 1 |
| 38 | 44 | PDC38 | 1 |
| 50 | 60 | PDC50 | 1 |



ENATS
(12-24)

Polyduct coupling

Ridgiduct Power Duct (non-standard sizes)

| ID mm | OD mm | Length m | Code | Coupler code | Pack qty |
|-------|-------|----------|--------|--------------|----------|
| 94 | 110 | 6 | RB94X6 | RBC94 | 95 |

Note: Available as a sealed system using CRD94 couplings and SRD94 sealing rings.



ENATS
(12-24)

Ridgiduct Power Duct

Ridgicoil Power

Ridgicoil Power

Ridgicoil is a coiled twinwall cable protection duct, manufactured from polyethylene with an excellent impact resistance even at low temperatures. It has exceptional durability and flexibility, which eliminates the need for specialist bends. With a smooth bore, Ridgicoil has a low co-efficient of friction for ease of cable installation.



PA05/05875

Note: Sizes 63mm and 110mm only.



Ridgicoil Power key benefits

- Complies with BS EN 61386-24:2010, Type 450N, normal duty impact resistance
- Provides compressive strength 450N at 23°C, but not an ENATS 12-24 approved product
- Network Rail PADS approved
- Ease of use and transportation
- Can be used for trenchless applications
- Long coil lengths for reduced jointing
- Low weight high strength
- Factory installed polypropylene twine and coupling

Ridgicoil Power Duct

| ID mm | OD mm | Length m | Code |
|-------|-------|----------|-------------|
| 31 | 40 | 50 | RC40X50BE |
| 40 | 50 | 50 | RC50X50BE |
| 50 | 63 | 50 | RC63X50BE* |
| 60 | 75 | 50 | RC75X50BE |
| 71 | 90 | 50 | RC90X50BE |
| 94 | 110 | 50 | RC110X50BE* |
| 140 | 160 | 25 | RC160X25BE |

Printed Electrical Cable Duct.
*Network Rail PADS approved.

Power - accessories



Ridgiduct bend

Ridgiduct Black Long Radius Drawn Bends

| ID mm | Bend radius mm | Angle | Code | Pack qty |
|-------|----------------|--------|-----------------|----------|
| 94mm | 420 | 11.25° | RBDB94X11X0.42 | 10 |
| | 420 | 22.5° | RBDB94X22X0.42 | 10 |
| | 420 | 45° | RBDB94X45X0.42 | 7 |
| | 420 | 90° | RBDB94X90X0.42 | 7 |
| 100mm | 420 | 11.25° | RBDB100X11X0.42 | 10 |
| | 420 | 22.5° | RBDB100X22X0.42 | 10 |
| | 420 | 45° | RBDB100X45X0.42 | 7 |
| 125mm | 420 | 90° | RBDB100X90X0.42 | 7 |
| | 600 | 11.25° | RBDB125X11X0.6 | 7 |
| | 600 | 22.5° | RBDB125X22X0.6 | 7 |
| 150mm | 600 | 45° | RBDB125X45X0.6 | 4 |
| | 600 | 90° | RBDB125X90X0.6 | 3 |
| | 610 | 11.25° | RBDB150X11X0.61 | 5 |
| | 610 | 22.5° | RBDB150X22X0.61 | 5 |
| | 610 | 45° | RBDB150X45X0.61 | 4 |
| | 610 | 90° | RBDB150X90X0.61 | 3 |

Ridgiduct Power Split Duct

| ID mm | OD mm | Length m | Code | Pack qty |
|-------|-------|----------|------------|----------|
| 100 | 118 | 1 | RB100X15 ▲ | 85 |
| 100 | 118 | 3 | RB100X35 ▲ | 85 |
| 125 | 148 | 1 | RB125X15 ▲ | 46 |
| 125 | 148 | 3 | RB125X35 ▲ | 46 |
| 150 | 178 | 1 | RB150X15 ▲ | 36 |
| 150 | 178 | 3 | RB150X35 ▲ | 36 |

▲ Made to order and subject to lead times.



Ridgiduct power split duct

Ridgiduct power split duct is mainly used as retrofit ducting for existing cables.

Ridgiduct Split Duct Fittings

| Description | ID mm | Code | Pack qty |
|----------------|-------|---------|----------|
| 100mm Coupling | 100 | CRBS100 | 10 |
| 150mm Coupling | 150 | CRBS150 | 10 |

Ridgiduct to PVCu Connectors

| Description | Code | Pack qty |
|---|-------------------|----------|
| SOCKET TO SPIGOT | | |
| 100mm Ridgiduct socket to 110mm PVCu spigot | ARD100110 | 10 |
| 150mm Ridgiduct socket to 160mm PVCu spigot | ARD150160 | 10 |
| SOCKET TO SOCKET | | |
| 100mm Ridgiduct socket to 110mm PVCu socket | ARD100110 & UG401 | 10 |
| 150mm Ridgiduct socket to 160mm PVCu socket | ARD150160 & UG601 | 10 |



ARD150160



ARD100110

Cable Guard

| Diameter inches | Diameter mm | Length ft | Code | Pack qty |
|-----------------|-------------|-----------|------------|----------|
| 0.75 | 19 | 10 | CG002X10 ▲ | 25 |
| 1.0 | 25 | 10 | CG003X10 ▲ | 25 |
| 1.5 | 38 | 10 | CG004X10 ▲ | 10 |
| 2.0 | 50 | 10 | CG005X10 ▲ | 10 |
| 2.5 | 64 | 10 | CG006X10 ▲ | 10 |
| 3.0 | 80 | 10 | CG007X10 ▲ | 5 |
| 4.0 | 100 | 10 | CG008X10 ▲ | 5 |

▲ Made to order and subject to lead times.



Cable guard

Hockey Sticks

| Utility provider | Size mm | Colour | Code | Pack qty |
|----------------------------|---------|--------|---------------|----------|
| UK Power Networks | 39 | White | HSPV018WHITE | 25 |
| SSE | 38 | Black | HSPV017SEBBLK | 25 |
| SSE | 38 | White | HSPV01WHITE | 25 |
| Western Power Distribution | 37 | White | HSPV016WHITE | 25 |



Hockey stick

Power - General purpose (not ENATS compliant)

General Purpose Duct

General Purpose Duct is an integrally socketed duct manufactured from PVCu. It is a cost-effective alternative to higher specification systems for use in light and medium duty applications. The General Purpose Duct system also includes a range of bends, junctions, hockey sticks and end caps. The system is manufactured to traditional accepted dimensions, but does not meet the requirements of BS EN 61386-24:2010. General Purpose Duct is not suitable for Highways England applications and will require a better standard of installation than more robust systems for successful performance. For BBA HAPAS approved power ducting, [please see Ridgiduct Power on page 114](#).



| General Purpose Duct | | | | | |
|----------------------|-------|-------------------|----------|--------|----------|
| OD inches | OD mm | Wall thickness mm | Length m | Code | Pack qty |
| 2 | 54 | 1.5 - 1.7 | 6 | GP2X6B | 400 |
| 3 | 89 | 1.8 - 2.2 | 6 | GP3X6B | 144 |
| 4 | 114 | 1.8 - 2.1 | 6 | GP4X6B | 86 |
| 6 | 168 | 2.2 - 2.9 | 6 | GP6X6B | 36 |
| 8 | 206 | 3.2 - 3.6 | 6 | GP8X6B | 25 |

General purpose ducting lengths include integral socket.
Note: This product comes in colour grey to black for both pipe and fittings.
All sizes are nominal.



General purpose bend

| General Purpose Bends | | | | | |
|-----------------------|-------|-----------|--------|-----------|----------|
| Diameter inches | OD mm | Radius mm | Angle | Code | Pack qty |
| 2 | 54 | 225 | 11.25° | GPB2X11 ▲ | 60 |
| 2 | 54 | 225 | 22.5° | GPB2X22 ▲ | 60 |
| 2 | 54 | 225 | 45° | GPB2X45 | 60 |
| 2 | 54 | 225 | 90° | GPB2X90 | 50 |
| 3 | 89 | 350 | 11.25° | GPB3X11 ▲ | 25 |
| 3 | 89 | 350 | 22.5° | GPB3X22 ▲ | 25 |
| 3 | 89 | 350 | 45° | GPB3X45 | 15 |
| 3 | 89 | 350 | 90° | GPB3X90 | 10 |
| 4 | 114 | 460 | 11.25° | GPB4X11 ▲ | 10 |
| 4 | 114 | 460 | 22.5° | GPB4X22 ▲ | 10 |
| 4 | 114 | 460 | 45° | GPB4X45 | 10 |
| 4 | 114 | 460 | 90° | GPB4X90 | 7 |
| 6 | 168 | 610 | 11.25° | GPB6X11 ▲ | 3 |
| 6 | 168 | 610 | 22.5° | GPB6X22 ▲ | 3 |
| 6 | 168 | 610 | 45° | GPB6X45 | 3 |
| 6 | 168 | 610 | 90° | GPB6X90 | 3 |
| 8 | 206 | 2500 | 11.25° | GPB8X11 ▲ | 1 |
| 8 | 206 | 2500 | 22.5° | GPB8X22 ▲ | 1 |
| 8 | 206 | 2500 | 45° | GPB8X45 | 1 |
| 8 | 206 | 2500 | 90° | GPB8X90 | 1 |

▲ Made to order and subject to lead times.
Note: This product comes in colour grey to black for both pipe and fittings.

General Purpose Hockey Sticks, Junctions, End Caps

| Diameter inches | Diameter mm | Code | Pack qty |
|-----------------|-------------|------------|----------|
| HOCKEY STICKS | | | |
| 2 | 54 | GPHS2 ▲ | 25 |
| CONNECTORS | | | |
| 2 | 54 | GPC2 | 10 |
| 3 | 89 | GPC3 | 60 |
| 4 | 114 | GPC4 | 40 |
| 6 | 168 | GPC6 | 15 |
| 8 | 206 | GPC8 | 1 |
| 45° JUNCTIONS | | | |
| 2 | 54 | GPJY2X45 ▲ | 1 |
| 3 | 89 | GPJY3X45 ▲ | 1 |
| 4 | 114 | GPJY4X45 ▲ | 1 |
| 6 | 168 | GPJY6X45 ▲ | 1 |
| 8 | 206 | GPJY8X45 ▲ | 1 |
| 90° JUNCTIONS | | | |
| 2 | 54 | GPJT2X90 ▲ | 1 |
| 3 | 89 | GPJT3X90 ▲ | 1 |
| 4 | 114 | GPJT4X90 ▲ | 1 |
| 6 | 168 | GPJT6X90 ▲ | 1 |
| 8 | 206 | GPJT8X90 ▲ | 1 |
| END CAPS | | | |
| 2 | 54 | GPEC2 | 10 |
| 3 | 89 | GPEC3 | 10 |
| 4 | 114 | GPEC4 | 10 |
| 6 | 168 | GPEC6 | 10 |
| 8 | 206 | GPEC8 | 10 |

▲ Made to order and subject to lead times.



General purpose Hockey stick



General purpose 45° Junction



General purpose 90° Junction



General purpose End cap



Suretwin Duct

Suretwin

Suretwin is a cost-effective alternative to conventional cable protection systems where a BBA or ENATS compliant duct is not required. The Suretwin system is currently available in 150mm diameter and meets the stiffness and normal duty impact requirements of BS EN 61386-24:2010, Type 450 only.

| Suretwin | | | | |
|----------|-------|----------|-----------|----------|
| ID mm | OD mm | Length m | Code | Pack qty |
| 150 | 178 | 6 | GPT150X6B | 36 |

Motorway Communications

Ridgiduct Motorway Communications

We are able to offer Ridgiduct Motorway Communications 94, 100 and 150mm as a sealed system specifically designed for motorway communications applications. Manufactured from HDPE, Ridgiduct is fully integrated with Polypipe access boxes (refer to Lighting section, [page 122](#)). It complies with BS EN 61386-24:2010, certifying 450N normal duty compression performance at 23°C and meets the requirements of Series 1500 Specification for Highway Works.



Ridgiduct Motorway Communications key benefits

- IP47 rated sealed system (watertight up to 1 metre)
- BBA HAPAS certified as a fully sealed system
- Complies with BS EN 61386-24:2010, Type 450N, normal duty impact resistance
- Network Rail PADS approved
- Print options available
- Can be used for trenchless applications
- Supplied with an integral coupler
- Low weight, flexible, durable and high strength
- Good impact resistance even at lower temperatures

Ridgiduct Motorway Communications Duct

| ID mm | OD mm | Length m | Code | Pack qty |
|-------|-------|----------|----------------|----------|
| 94 | 110 | 6 | RB94X6PMCPE/1 | 95 |
| 100 | 118 | 6 | RB100X6PMCPE | 85 |
| 150 | 178 | 6 | RB150X6PMCPE ▲ | 36 |

▲ Made to order and subject to lead times.
Conforms to Highways Agency Specification for sealed systems.
For Scottish market printed Motorway Comms/Power.
Other print options available.



Couplers and Seals

| ID mm | Coupler code | Seal code |
|-------|--------------|-----------|
| 94 | CRD94 | SRD94/1 |
| 100 | CRD100 | SRD100 |
| 150 | CRD150 | SRD150 |

1 coupler and 2 seals per joint.

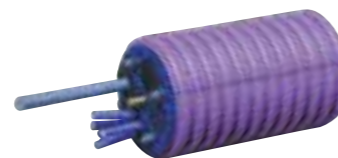

Comtite™ Ducting Plug

Comtite™ cable protection plugs, when used in conjunction with the insertable cable grommets, ensures full compliance with the requirements of Series 1500 Specification for Highway Works (MCHW) and is the only transit system accredited by the BBA for motorway communications. When used with Ridgiduct, it completes a certified sealed system.

Comtite™ Ducting Plug key benefits

- IP47 rated sealed system (watertight up to 1 metre)
- BBA HAPAS approved
- Allows for rapid fitting, both new and retrofit
- Integral test valve
- Design resists ejection from the cable protection
- All 4 ports can be utilised by the use of an additional draw cord bracket
- Blanking grommet with rope attachment point

Comtite™ Ducting Plug

| Description | Code | Length m |
|---|----------|----------|
| 94mm plug | DP94 ▲ | 40 |
| 100mm plug | DP100 ▲ | 40 |
| Blanking grommet with rope attachment point | DPG0 ▲ | 10 |
| 9mm grommet | DPG9 ▲ | 10 |
| 12mm grommet | DPG12 ▲ | 10 |
| 14mm grommet | DPG14 ▲ | 10 |
| 16mm grommet | DPG16 ▲ | 10 |
| 18mm grommet | DPG18 ▲ | 10 |
| 21mm grommet | DPG21 ▲ | 10 |
| 24mm grommet | DPG24 ▲ | 10 |
| 27mm grommet | DPG27 ▲ | 10 |
| 4 x 9mm grommet | DPG9X4 ▲ | 10 |
| 7 x 9mm grommet | DPG9X7 ▲ | 10 |

▲ Made to order and subject to lead times.
4 grommets required per plug. In order to achieve a sealed plug, use a blanking grommet where cable grommet is not required.
Patented product.



Ridgicoil Motorway Communications

Ridgicoil is a coiled twinwall cable protection duct, manufactured from polyethylene with an excellent impact resistance even at low temperatures. It has exceptional durability and flexibility, which eliminates the need for specialist bends. With a smooth bore, Ridgicoil has a low co-efficient of friction for ease of cable installation.

Ridgicoil Motorway Communications Duct

| ID mm | OD mm | Length m | Code |
|-------|-------|----------|--------------|
| 50 | 63 | 50 | RC63X50PMCP |
| 94 | 110 | 50 | RC110X50PMCP |



Duct Spacers

High quality injection moulded spacers are available to secure multiple installations of all 94 and 100mm diameter ducts. The unique modular design enables multiple configurations to be assembled. Duct spacers comply with the requirements of MCHW 1530.

Duct Spacers

| Description | Duct ID mm | Code | Pack qty |
|--|------------|----------|----------|
| 2 way Duct Spacer (to suit 110mm O.D.) ▲ | 94 | RBS110X2 | 50 |
| 4 way Duct Spacer (to suit 110mm O.D.) | 94 | RBS110X4 | 25 |
| 6 way Duct Spacer (to suit 110mm O.D.) ▲ | 94 | RBS110X6 | 12 |
| 2 way Duct Spacer (to suit 118mm O.D.) ▲ | 100 | RBS118X2 | 50 |
| 4 way Duct Spacer (to suit 118mm O.D.) | 100 | RBS118X4 | 25 |
| 6 way Duct Spacer (to suit 118mm O.D.) ▲ | 100 | RBS118X6 | 12 |

▲ Made to order and subject to lead times.
Note: Highways England requires 1 per metre.



Duct spacers

Draw cord

Draw cord is manufactured from high quality polypropylene to a nominal breaking strength of 5kN.

Draw Cord

| Description | Pallet qty | Code |
|-------------------------------|------------|-------|
| 6mm dia. x 220m | 160 | DC220 |
| 6mm dia. x 500m (wooden drum) | 72 | DC500 |



Draw cord

Special note for applications subject to Highways England requirements

It should be noted that a number of versions of the Manual of Contract Documents for Highway Works are in use and individual contracts can be subject to substantial variation. Suitability should always be checked with the overseeing organisation. Products selected should be BBA approved or meet the requirements of Table 5/2 unless exceptional requirements demand an alternative. It should also be noted that there are differences between requirements for ducts in Series 500 and 1500 of the Specification for Highway Works.

Lighting

Ridgiduct Lighting

Ridgiduct Lighting is a twinwall, low weight, flexible cable protection system, specially manufactured from HDPE in orange for use in street lighting and traffic signal applications. A full range of access and junction boxes, bends, reducers and adaptors are available.



Ridgiduct Lighting key benefits

- Complies with BS EN 61386-24:2010, Type 450N, normal duty impact resistance
- BBA and BBA HAPAS approved
- Network Rail PADS approved
- Good impact resistance, even at low temperatures
- Flexible in application, with a minimal requirement for special bends
- Available with print options for street lighting and traffic signals
- Supplied with an integral coupler
- Low weight, flexible, durable and high strength

| Ridgiduct Lighting Duct | | | | | |
|-------------------------|-------|----------|----------------------|----------|--|
| ID mm | OD mm | Length m | Code | Pack qty | |
| 94 | 110 | 6 | RB94X6O(SL or TS) | 95 | |
| 100 | 118 | 6 | RB100X6O(SL or TS) ▲ | 85 | |
| 150 | 178 | 6 | RB150X6O(SL or TS) | 36 | |

▲ Made to order and subject to lead times. Available with street lighting (SL) or traffic signal (TS) print. Please specify with order.



PA05/05875
Note: 100mm and 150mm only.



Polyduct Lighting

Polyduct Lighting is a single wall alternative to twinwall cable protection. Manufactured in orange HDPE, it can be used in either open trench or trenchless applications.



Polyduct Lighting



Polyduct Lighting bend

| Polyduct Lighting Duct | | | | | | |
|------------------------|-------|-------------------|----------|-----------------------|----------|--|
| ID mm | OD mm | Wall thickness mm | Length m | Code | Pack qty | |
| 50 | 60 | 5 | 6 | PD5060X6O(TS or SL) | 250 | |
| 56 | 63 | 3.5 | 6 | PD5663X6O(TS or SL) | 250 | |
| 100 | 107 | 3.5 | 6 | PD100107X6O(TS or SL) | 85 | |
| 97 | 107 | 5 | 6 | PD97107X6O(TS or SL) | 85 | |

Available with street lighting (SL) or traffic signal (TS) print. Please specify with order.

| Polyduct Lighting Bends | | | | | |
|-------------------------|-------|-----------|------------|----------|--|
| OD mm | Angle | Radius mm | Code | Pack qty | |
| 60 | 45° | 350 | PDB60X45O | 25 | |
| 60 | 90° | 225 | PDB60X90O | 25 | |
| 63 | 45° | 350 | PDB63X45O | 25 | |
| 63 | 90° | 225 | PDB63X90O | 25 | |
| 107 | 45° | 450 | PDB107X45O | 1 | |
| 107 | 90° | 450 | PDB107X90O | 1 | |

Ridgicoil Lighting

Ridgicoil is a coiled, twinwall cable protection duct, manufactured from polyethylene with an excellent impact resistance even at low temperatures. It has exceptional durability and flexibility, which eliminates the need for specialist bends. With a smooth bore, Ridgicoil has a low co-efficient of friction for ease of cable installation.

| Ridgicoil Lighting Duct | | | |
|-------------------------|-------|----------|---------------------|
| ID mm | OD mm | Length m | Code |
| 50 | 63 | 50 | RC63X50O(SL or TS) |
| 94 | 110 | 50 | RC110X50O(SL or TS) |

Available with street lighting (SL) or traffic signal (TS) print. Please specify with order.



PA05/05875
Note: Sizes 63mm and 110mm only.

Ridgicoil Lighting key benefits

- Complies with BS EN 61386-24:2010, Type 750N, normal duty impact resistance
- Network Rail PADS approved
- Ease of use and transportation
- Long coil lengths for reduced jointing
- Factory installed polypropylene twine and coupling
- Low weight high strength
- Can be used for trenchless applications

Scottish Lighting

Lighting in Scotland has specific requirements and for this purpose we manufacture a single wall cable protection range. Supplied with 1 coupling fitted per length.

| Scottish Lighting Purple Cable Protection & Fittings | | | |
|--|----------|-------|------------------|
| Description | Size mm | ID mm | Code |
| SCOTTISH LIGHTING SINGLE WALL CORRUGATED | | | |
| 100m Scottish Lighting coil | 60 | 53 | SSL60X100P ▲ |
| 40m Scottish Lighting coil | 100 | 90 | SSL100X40P ▲ |
| SCOTTISH LIGHTING JUNCTION BOXES | | | |
| | 100 | | SSLJB100 ▲ |
| SCOTTISH LIGHTING CONNECTORS | | | |
| | 60 | | SSLC60 ▲ |
| | 100 | | SSLC100 ▲ |
| SCOTTISH LIGHTING REDUCERS | | | |
| Slotted | 100 X 60 | | SSLR100X60Slot ▲ |
| Unslotted | 100 X 60 | | SSLR100X60 ▲ |
| SCOTTISH LIGHTING END CAP | | | |
| | 100 | | SSLEC4PIN |

▲ Made to order and subject to lead times. Purple as standard. Other colours available on request. Minimum order 50 coils.



Scottish Lighting Coil



Scottish Lighting end cap

Scottish Lighting slotted reducer

Lighting

Pole boxes

The range of 4 pole boxes is available in 290 x 275mm and 450 x 450mm sizes, incorporating integral housings for 114 and 140mm poles and are manufactured from polyethylene. The pole box provides 450mm depth of cover as standard, extendable if required using modular access boxes as rising sections.

Pole boxes and access boxes key benefits

- Robust, single-piece injection or rotational mouldings
- High strength, structured wall construction
- Manufactured in impact resistant polyethylene for installation in all conditions
- Corrosion free and chemical resistant material
- Ultraviolet light resistant material, suitable for extended storage periods
- Light, easy to handle, transport and install
- Modular construction, allowing access boxes to be used as rising sections as required
- Pre-trepanned points of entry to accommodate 54, 63, 110 and 118mm outside diameter ducting
- Can also be stacked



| Pole Boxes | | | | | | | |
|-------------|-------------|-----------|----------|----------|----------|----------|--------------------|
| Code | Description | Height mm | Opening | | External | | Pole housing ID mm |
| | | | Width mm | Depth mm | Width mm | Depth mm | |
| PB2902751 ▲ | 290 x 275 | 615 | 320 | 305 | 690 | 415 | 114 |
| PB2902752 ▲ | 290 x 275 | 615 | 320 | 305 | 690 | 415 | 140 |
| PB4504501 ▲ | 450 x 450 | 605 | 465 | 465 | 875 | 600 | 114 |
| PB4504502 ▲ | 450 x 450 | 605 | 465 | 465 | 875 | 600 | 140 |

▲ Made to order and subject to lead times.
The clear opening for boxes is greater than the clear opening for frames.

Access boxes

Access boxes are available in 5 sizes, from 290 x 275mm to 600 x 600mm to allow access to cabling.



| Access Boxes | | | | | | | |
|--------------|-------------|-----------|----------|----------|----------|----------|----------|
| Code | Description | Height mm | Opening | | External | | Depth mm |
| | | | Width mm | Depth mm | Width mm | Depth mm | |
| AC2902751 | 290 x 275 | 307 | 320 | 310 | 385 | 375 | |
| AC4503001 | 450 x 300 | 305 | 485 | 330 | 550 | 395 | |
| AC4504501 | 450 x 450 | 330 | 475 | 475 | 545 | 545 | |
| AC6004501 | 600 x 450 | 320 | 635 | 485 | 700 | 550 | |
| AC6006001 | 600 x 600 | 320 | 635 | 635 | 700 | 700 | |

The clear opening for boxes is greater than the clear opening for frames.
See the relevant tables for details of clear opening frames.

Composite covers

Advanced skid resistance composite covers are available for the range of pole and access boxes. Manufactured in high strength, fibre-reinforced polyester resin and to BS EN 124 Class B 125.

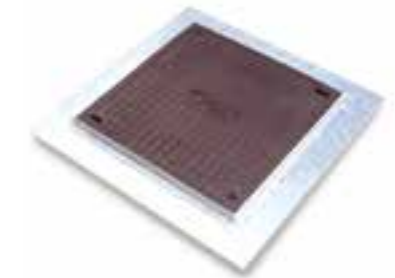

Composite cover

| Composite Covers | | Composite Cover Frames | |
|------------------|-----------------|------------------------|-----------------|
| Code | Nominal size mm | Code | Nominal size mm |
| CC290275 | 290 x 275 | CCF290275L | 290 x 275 |
| CC450300 | 450 x 300 | CCF450300L | 450 x 300 |
| CC450450 | 450 x 450 | CCF450450L | 450 x 450 |
| CC600450 | 600 x 450 | CCF600450L | 600 x 450 |
| CC600600 | 600 x 600 | CCF600600L | 600 x 600 |

A locking frame is required and must be ordered separately.

Galvanised steel covers

Galvanised steel covers and frames are manufactured to the FACTA (Fabricated Access Cover Trade Association) Class B specification, equivalent to BS EN 124 Class B 125. Typical places of installation include areas subject to slow moving wheel loads, including footways, pedestrian areas, car parks and verges.



Galvanised steel cover

| Galvanised Steel Covers & Frames | |
|----------------------------------|-----------------|
| Code | Nominal size mm |
| GCF290275 | 290 x 275 |
| GCF450300 | 450 x 300 |
| GCF450450 | 450 x 450 |
| GCF600450 | 600 x 450 |
| GCF600600 | 600 x 600 |

Ductile iron covers and frames

Ductile iron access box covers are manufactured to BS EN 124 Class B 125.



Ductile iron cover

| Ductile Iron Covers & Frames | |
|------------------------------|------------------|
| Code | Clear opening mm |
| DCF450450 ▲ | 450 x 450 |
| DCF600450 ▲ | 600 x 450 |
| DCF600600 ▲ | 600 x 600 |

▲ Made to order and subject to lead times.

Utilities

Our range of utility ducting is available in a variety of NJUG classification colours to provide cable protection for electricity, street lighting, motorway communications, gas, water, cable TV and telecommunications.



KEY - Typical NJUG colour coding

| | |
|---|--------------------------------|
| Black (B) - Electricity | Yellow (Y) - Gas |
| Orange (O) - Street Lighting | Blue (BL) - Water |
| Purple (P) - Street Lighting (Scotland) | Green (G) - Cable Television |
| Purple (P) - Motorway Communications | Grey (GR) - Telecommunications |

Ridgicoil Utilities

Ridgicoil is a strong yet flexible alternative to conventional twinwall ducting manufactured from polyethylene for underground utilities. Ridgicoil's flexibility eliminates the need for special bends and the smooth bore has a low co-efficient of friction for ease of cable installation.

| ID mm | OD mm | Length m | Code | Colours |
|-------|-------|----------|------------|------------|
| 31 | 40 | 50 | RC40X50 | B |
| 40 | 50 | 50 | RC50X50 | B Y BL |
| 50 | 63 | 50 | RC63X50** | Y BL O G P |
| 60 | 75 | 50 | RC75X50 | B |
| 71 | 90 | 50 | RC90X50 | B |
| 94 | 110 | 50 | RC110X50** | Y BL O G P |
| 140 | 160 | 25 | RC160X25 | B |

*Please check the requirements of the utility company, who may stipulate a requirement for perforated duct. For perforated duct please see Gas Ducting on page 127.
**Network Rail PADS approved.

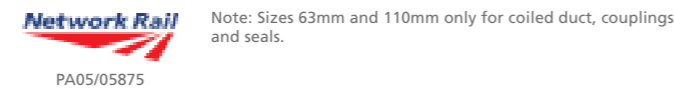

Ridgicoil couplings & seals

| Ridgicoil Couplings | | | Ridgicoil Seals | | |
|---------------------|---------|----------|-----------------|---------|----------|
| OD mm | Code | Pack qty | OD mm | Code | Pack qty |
| 40 | RCC40 | 10 | 40 | RCS40 | 10 |
| 50 | RCC50 | 10 | 50 | RCS50 | 10 |
| 63 | RCC63* | 10 | 63 | RCS63* | 10 |
| 75 | RCC75 | 10 | 75 | RCS75 | 10 |
| 90 | RCC90 | 10 | 90 | RCS90 | 10 |
| 110 | RCC110* | 10 | 110 | RCS110* | 10 |
| 160 | RCC160 | 10 | 160 | RCS160 | 10 |

*Network Rail PADS approved



Ridgicoil coupling



Ridgicoil seals

Ridgiduct Utilities

Ridgiduct is a lightweight, twinwall cable protection system that can be manufactured in a range of NJUG classification colours, from HDPE, to meet the cable protection needs of all utilities applications.



| ID mm | OD mm | Length m | Code | Colours | Pack qty |
|-------|-------|----------|-----------|--------------|----------|
| 94 | 110 | 6 | RB94X6 | B Y BL O G P | 95 |
| 100 | 118 | 6 | RB100X6 | B Y BL O G P | 85 |
| 150 | 178 | 6 | RB150X6 | B Y BL O G P | 36 |
| 225 | 266 | 6 | RB225X6** | B Y BL | 14 |
| 300 | 354 | 6 | RB300X6** | B Y BL | 9 |

*Please check the requirements of the utility company, who may stipulate a requirement for perforated duct. For perforated duct please see Gas Ducting below.
**Not BBA approved.



Gas Ducting

Some utility companies specify this product and stipulate a perforated gas duct is used. Our Gas Ducting is a PVCu single wall perforated duct, supplied in yellow and manufactured to BS 4962.

| OD mm | Length m | Description | Code |
|-------|----------|-------------|-------------|
| 60 | 25 | Perforated | LD6025YGAS |
| 60 | 50 | Perforated | LD6050YGAS |
| 60 | 150 | Perforated | LD60150YGAS |
| 100 | 25 | Perforated | LD10025YGAS |
| 100 | 50 | Perforated | LD10050YGAS |

Ducting accessories

| Ridgiduct Accessories | | |
|-------------------------------|-----------|----------|
| Size mm | Code | Pack qty |
| SINGLE SOCKET FIXED BELLMOUTH | | |
| 94 | RBBM94 ▲ | 1 |
| 100 | RBBM100 ▲ | 1 |
| 125 | RBBM125 ▲ | 1 |
| 150 | RBBM150 ▲ | 1 |
| PLASTIC END CAP | | |
| 94 | RBEC94 | 1 |
| 100 | EC1059 | 1 |
| 125 | EC3051 | 1 |
| 150 | EC1778 | 1 |

▲ Made to order and subject to lead times. End caps may be red or yellow.



Gas ducting



Single socket fixed bellmouth



Plastic end cap

Ridgiduct Utilities key benefits

- Complies with BS EN 61386-24:2010, Type 450N, normal duty impact resistance
- BBA HAPAS approved
- Network Rail PADS approved
- Low weight, flexible, durable and high strength
- Good impact resistance at low temperatures
- Available from stock
- Available in a range of colours which comply with NJUG classifications
- Supplied with an integral coupler
- Print options available

Utilities

PVCu Cable TV Duct

A range of specialist PVCu telecommunications ducting systems, manufactured in accordance with dimensions and performance requirements tried and tested by the telecommunications industry.



PVCu Cable TV Duct key benefits

- Durable, high quality construction
- Low co-efficient of friction for easy cable installation
- A short 54mm branch on swept tees for trouble-free installation in congested footways
- PVCu telecommunication ducts include integral sockets and are available in green as standard. Grey and other colours are also available on request subject to minimum order quantities and lead times



PVCu Cable TV bend



PVCu Cable TV coupling

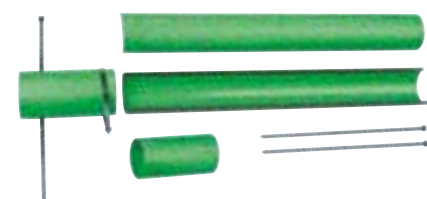

PVCu Cable TV duct repair kit

| PVCu Cable TV Duct | | | | | |
|--------------------|-------|----------|--------|---------|----------|
| ID mm | OD mm | Length m | Code | Colours | Pack qty |
| 49 | 54 | 6 | TD54X6 | G GR ▲ | 400 |
| 90 | 96.5 | 6 | TD96X6 | G GR * | 121 |

▲ Made to order and subject to lead times. Available in green (G) or grey (GR). Please specify with order. *90mm green and grey duct meet the requirements of BS EN 50086.

| PVCu Cable TV Swept Tees | | | |
|--------------------------|------------|---------|----------|
| Description | Code | Colours | Pack qty |
| 96 x 54mm | TDJT96X54G | G ▲ | 15 |

▲ Made to order and subject to lead times.

| PVCu Cable TV Bends | | | | |
|---------------------|--------|--------------------|---------|----------|
| OD mm | Angle | Code | Colours | Pack qty |
| 54 | 11.25° | TDB54X11G | G ▲ | 60 |
| 54 | 22.5° | TDB54X22G | G ▲ | 60 |
| 54 | 45° | TDB54X45G | G ▲ | 60 |
| 54 | 90° | TDB54X90G | G ▲ | 50 |
| 96.5 | 11.25° | TDB96X11 (G or GR) | G GR ▲ | 15 |
| 96.5 | 22.5° | TDB96X22 (G or GR) | G GR ▲ | 15 |
| 96.5 | 45° | TDB96X45 (G or GR) | G GR ▲ | 15 |
| 96.5 | 90° | TDB96X90 (G or GR) | G GR ▲ | 10 |

▲ Made to order and subject to lead times. Available in green (G) or grey (GR). Please specify with order.

| PVCu Cable TV Couplings | | | |
|-------------------------|---------|---------|----------|
| Description | Code | Colours | Pack qty |
| 54mm | TDC54G | G ▲ | 10 |
| 54mm slip | TDSC54G | G ▲ | 10 |
| 96mm | TDC96G | G ▲ | 50 |
| 96mm slip | TDSC96G | G ▲ | 50 |

▲ Made to order and subject to lead times.

| PVCu Cable TV Duct Repair Kit | | | |
|-------------------------------|-------------------|----------|----------|
| Description | Standard length m | Code | Pack qty |
| 96.5mm duct repair kit | 0.5 | DRK096 ▲ | 1 |

▲ Made to order and subject to lead times. Components for repairing sections of damaged duct.

PVCu specification and utility ducts

Our specification and utility ducts are widely and successfully used for the carriage of all types of services in a range of applications including industrial, domestic and commercial. Specification ducts are more robust than General Purpose Duct. PVCu utility ducts were the first widely available thermoplastic ducts and are available in a number of different sizes to suit all common specification requirements.

| Type 4660 Non-Sealed Duct | | | |
|---------------------------|----------|------------|----------|
| OD mm | Length m | Code | Pack qty |
| 110 | 6 | SD110X6B ▲ | 95 |
| 160 | 6 | SD160X6B ▲ | 46 |

▲ Made to order and subject to lead times. (Dimensions compliant only)

| Type 4660 Couplings | | |
|---------------------|----------|----------|
| ID mm | Code | Pack qty |
| 110 | SDC110 ▲ | 1 |
| 160 | SDC160 ▲ | 1 |

▲ Made to order and subject to lead times. Grey to black in colour as standard, other colours available on request.

| Type 4660 Bends | | | |
|-----------------|--------|-------------|----------|
| OD mm | Angle | Code | Pack qty |
| 110 | 11.25° | SDB110X11 ▲ | 1 |
| 110 | 22.5° | SDB110X22 ▲ | 1 |
| 110 | 45° | SDB110X45 ▲ | 1 |
| 110 | 90° | SDB110X90 ▲ | 1 |
| 160 | 11.25° | SDB160X11 ▲ | 1 |
| 160 | 22.5° | SDB160X22 ▲ | 1 |
| 160 | 45° | SDB160X45 ▲ | 1 |
| 160 | 90° | SDB160X90 ▲ | 1 |

▲ Made to order and subject to lead times. Grey to black in colour as standard, other colours available on request.

| Type BS4660 Sealed Duct | | | |
|-------------------------|----------|--------------|----------|
| OD mm | Length m | Code | Pack qty |
| 110 | 6 | SD110X6BPE ▲ | 95 |
| 160 | 6 | SD160X6BPE ▲ | 46 |

▲ Made to order and subject to lead times. (Dimensions compliant only)

| Type BS4660 Couplings | | |
|-----------------------|----------|----------|
| ID mm | Code | Pack qty |
| 110 | UG402B ▲ | 1 |
| 160 | UG602B ▲ | 1 |

▲ Made to order and subject to lead times. Note: Order couplings separately.

| Type BS4660 Bends | | | |
|-------------------|-------|---------------|----------|
| OD mm | Angle | Code | Pack qty |
| 110 | 45° | SDB110X45PE ▲ | 1 |
| 110 | 90° | SDB110X90PE ▲ | 1 |
| 160 | 45° | SDB160X45PE ▲ | 1 |
| 160 | 90° | SDB160X90PE ▲ | 1 |

▲ Made to order and subject to lead times.

PVCu specification and utility duct key benefits

- 110 and 160mm utility ducting for electrical cables, water services, telecommunications and gas services
- 110 and 160mm OD Type 4660 ducting in dimensional compliance with BS 4660 available sealed and unsealed



Type 4660 bend



Type BS4660 coupling



Type BS4660 bend

Installation advice

Installation information

Ridgiduct twinwalled high density polyethylene (HDPE) cable protection must be installed in accordance with general requirements and any additional site requirements. The general requirements are to be in accordance with MCHW, Volume 3, as shown below. Cable protection laid in depths of cover, other than those specified below, must be laid in accordance with the procedures described in the contract with Highways England (HE). Ridgiduct must be adequately protected against damage from site construction traffic and from agricultural or similar operations. When used as cable protection for fibre optic cabling, the recommendations in BS 7718:1996 should be followed.

Procedure (unsealed)

Joints are made by a simple push-fit of one cable protection length into the coupler attached to the adjacent length, ensuring that the connection is fully made. Inspection points can be made in the conventional manner depending upon the type of services to be installed.

Pole and access box installation advice

We recommend that the systems be installed in general accordance with the traffic control signals unit (TCSU) specification. Our pole and access boxes are designed to meet the requirements of the TCSU, making installation easy and trouble-free. Local specifications and requirements may apply.

Covers and frames

Access box covers and frames should meet the requirements of BS EN 124 Class B 125. In carriageways or other locations where vehicles may run over access boxes, heavier grades of cover may be required.

General

In footways, cable protection for signal post cables and linking cables must have minimum cover depths of 450mm and 250mm respectively. The minimum depth of cover in carriageways is 600mm. Subject to local cable protection specification, cable protection should be bedded on 100mm of compacted bedding material. Cable protection lengths must be continuous and fully jointed, with the printing placed uppermost when laying.

Suitable surround material should also be used to fill any voids between multiple cable protection and should extend to 100mm above the cable protection. Polypropylene draw cords should be provided in each cable protection with no knots or joints and should extend a minimum of 1 metre into each access box.

Pole and access boxes

Cable protection ducting is easily connected to the selected entry point. The pre-trepanned section for the size of cable protection to be used can be cut out with a knife or hole saw. The cable protection should be inserted through the opening and cut to length. Boxes that may be subject to traffic loading are typically installed as illustrated.

Typical installations

Typical installation of a 450 x 450mm Access box subject to vehicle traffic

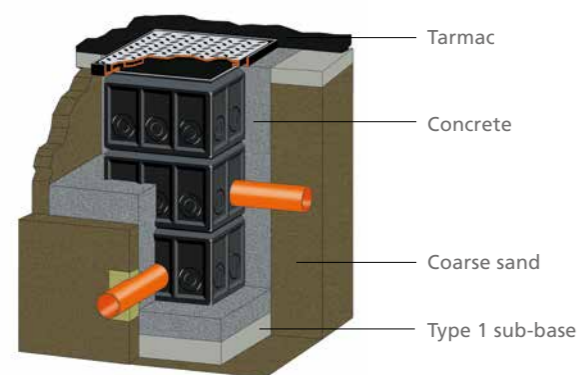

Typical unsealed standard duct installations type A shallow ducts (750 - 1200mm cover)

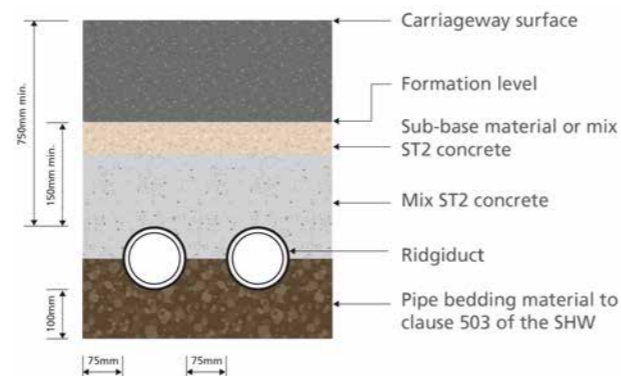

Type B deep cuts (over 1200mm cover)

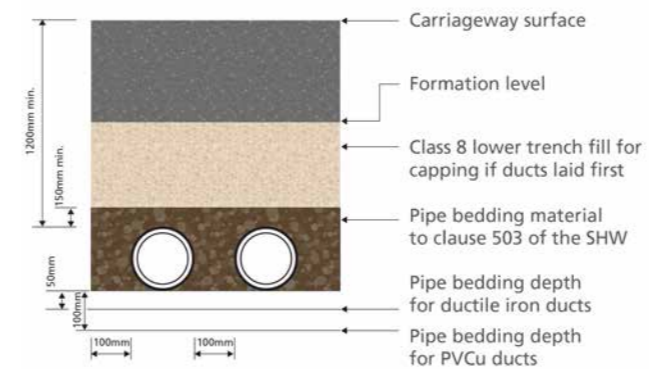

Minimum clearance between duct and drain



Typical installation of a Polypipe 450 x 450mm Pole box

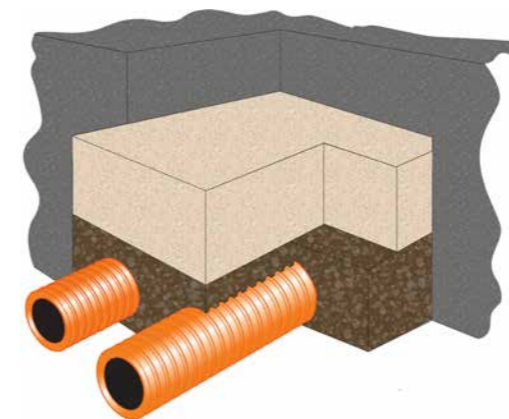
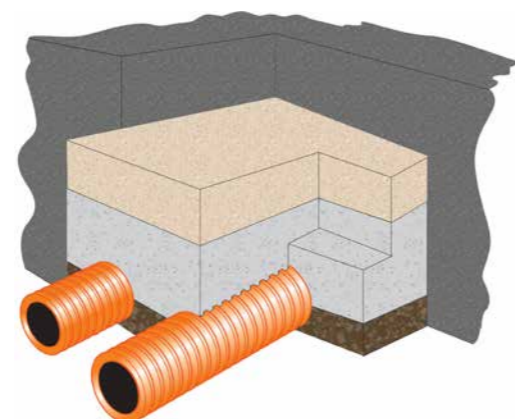
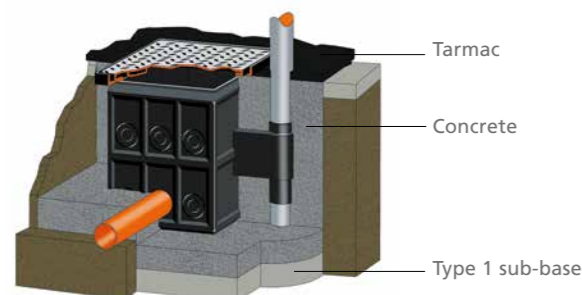

Motorway Communications installations should be in accordance with MCHW Series 1500. Please call our Technical Team on +44 (0) 1509 615100 for more information on installation details, multiple duct configurations and sealed systems.

The company

Polypipe is the UK's largest plastic pipe systems manufacturer, employing over 2,000 people and offering the largest product range in the country.



Unrivalled service

At Polypipe, we design, manufacture and deliver some of the most advanced thermoplastic products and systems in the UK. Through our commitment to industry expertise and our dedication to the highest standards of quality, we not only provide superior products, but superior standards of service. Our Support Teams are here to help you at every stage of your project, from planning through to maintenance. Through our sustainability drive you can rest assured that by using a Polypipe product, you are ensuring that your project takes the utmost environmental considerations into account.

The broadest product range

Offering well over 20,000 product lines, Polypipe has an enviable reputation amongst installers, contractors, stockists and specifiers for being able to provide exactly the right solution for any project. With over 100 product systems, our unmatched portfolio offers dependable, innovative solutions for pressure and non-pressure applications, enabling the movement of water, air, power, chemicals and telecommunications throughout the built environment.

Market leadership

As a respected industry leader, Polypipe continues to develop innovative products and solutions to meet changing market needs and growing demands. Customers trust us to provide fully engineered solutions for the growing diversity and complexity of the construction challenges they face. We have a significant UK manufacturing base that guarantees availability through a nationwide network of stockists and a dedicated, owned and managed logistics fleet.

Brand values

At Polypipe, we seek to deliver constant improvements in construction industry best practice by leading the way in product research and innovation, employing and retaining some of the most respected experts in the field and delivering the highest standards of customer service, value and reliability. We also define and drive quality in pipe manufacture and performance and use leading-edge technology to deliver whole-life value and sustainability by providing systems engineered to perform.

Contents

| | | |
|-------------------|--|-----------|
| SECTION 10 | The company | |
| | Company overview | 132 - 133 |
| | Innovation and research | 134 - 135 |
| | Polypipe project and technical support | 136 - 137 |
| | Online technical resources | 138 - 139 |
| | Enabling sustainable building technology | 140 |
| | Literature | 141 |



Innovation and research

At Polypipe, we always aim to bring innovative new products to the market in direct response to our customers' needs, requirements and feedback.



Challenging convention

We have always challenged convention by exploring new ways to meet the needs of the construction industry. Chief among them has been the development of thermoplastic piping systems to replace traditional concrete and clay materials. This results in solutions that are lighter in weight whilst also being tougher and more adaptable, ultimately making them more sustainable. Our priority is to always provide the industry with robust and innovative solutions that meet the demanding performance criteria of today's construction projects.

Customer driven innovation

We look to do things efficiently and to the highest standards, not only acting on customer requirements but also being proactive with project demands and meeting all changes in legislation. We value process innovation, strong manufacturing investment and product development. However, our prime concern is always to deliver the very highest quality for our customers in manufacturing, materials, service and supply.

Expert staff

Our materials and product development specialists represent some of the leading authorities in the industry. Many even have influential positions on trade bodies including the British Plastic Federation (BPF). It is their knowledge and experience that allows us to offer the very highest standards of product design and development.

Quality control

We invest heavily in research and new production technology. This allows us to provide more precise performance specifications, greater reliability and high quality products that are BBA, BSI Kitemark and WRc approved. Supporting our product accreditations, our business systems are regularly assessed by BSI to ensure we maintain our BS EN ISO 9001:2008 and BS EN ISO 14001:2004 certifications. This ensures we conform to regulatory requirements and that we provide greener credentials for our products.

Testing and certification

We work closely with regulatory bodies to ensure our products meet all UK and international regulations for performance and sustainability; a vital consideration in an industry where compliance and certification are absolute priorities. Wherever possible, our products are covered by third party accreditations, including BBA, BSI Kitemark, WRc and Network Rail Parts and Drawing Systems (PADS) approval.



UKAS accredited factories

Our UKAS accredited Berry and Hayward laboratory allows us to develop and test new materials and products 24 hours a day. This ensures that our products represent the best possible solution and significantly reduces the time in which new products can be brought to the market.

Polypipe project and technical support

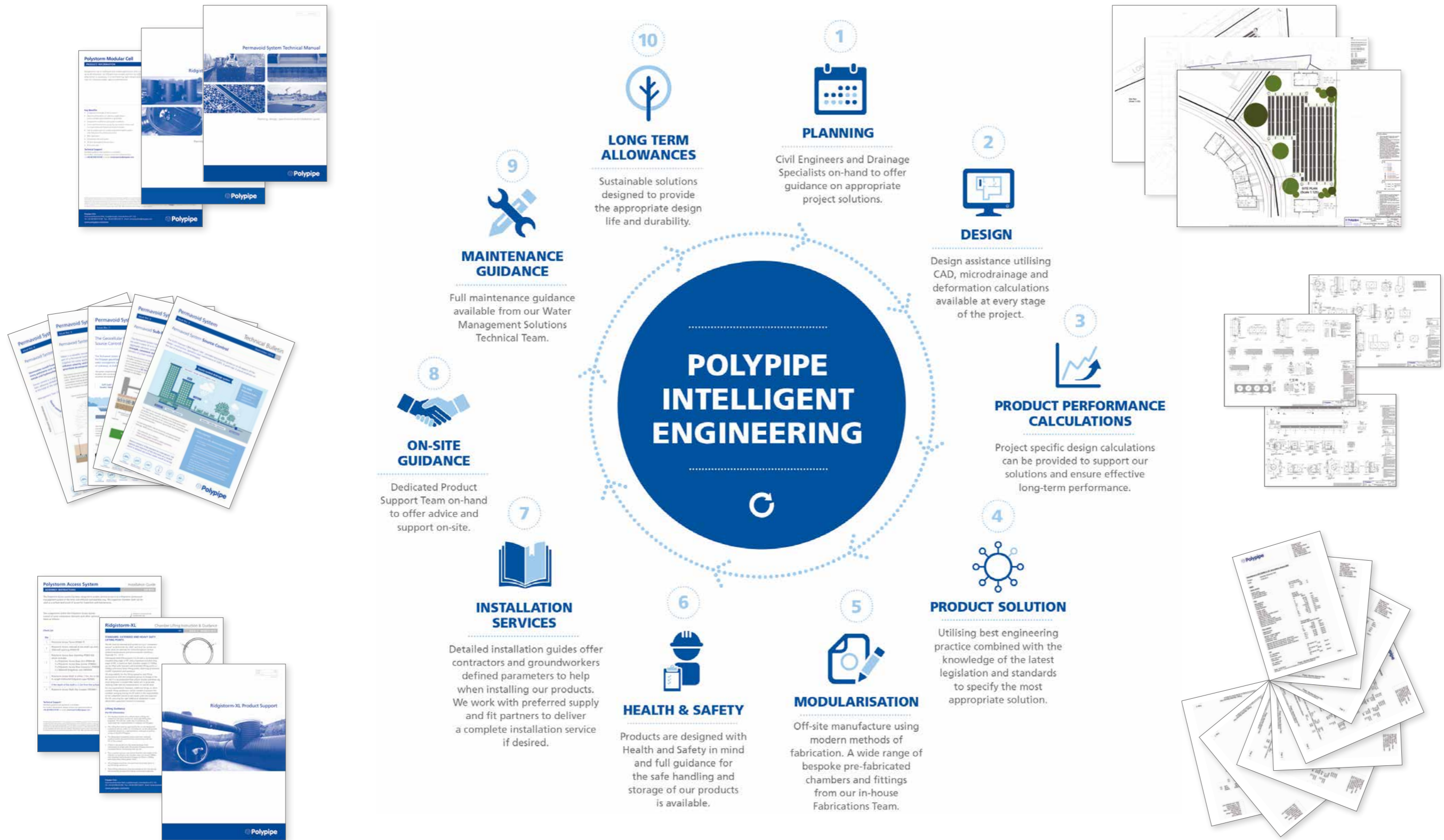

Online technical resources

At Polypipe, we offer a comprehensive selection of downloadable product and technical literature that is available on our website to provide you with detailed information about our systems and solutions.



Brochures and technical manuals

We provide an extensive range of brochures and technical manuals, which contain topics including:

- Structural design
- Hydraulic performance
- Chemical resistance
- Applications
- Installation guidance
- Maintenance
- Structural performance
- Pollution control
- Minimum cover depths

Technical bulletins

These bulletins offer an overview of the benefits offered by our products and guidance on the typical applications they can be used for as well as explanations of compliance requirements.

Standards, approvals and certifications

Available to download are all the BBA and WRc certificates needed to support your specification or contract.

Specification clauses, CAD drawings and technical datasheets

Our toolbox contains downloadable CAD drawings and specification clauses to ensure full design, manufacture and installation compliance, plus a full range of technical datasheets covering every product.

Installation guides, Health and Safety and COSHH datasheets

Guidance for easy, safe product handling, loading, off-loading and installation is available along with product safety information (COSHH) – supported by materials safety datasheets – which are also available to download from our website.

Case studies

Our website provides a broad range of recent case studies, including everything from infrastructure projects for roads, motorways, airports and energy, to residential developments, education, commercial and water company Capital Works projects.



www.polypipe.com/toolbox

Enabling sustainable building technology

At Polypipe, we provide plastic piping systems that enable the effective installation and performance of sustainable building technology, helping meet the twin global challenges of carbon reduction and water management.

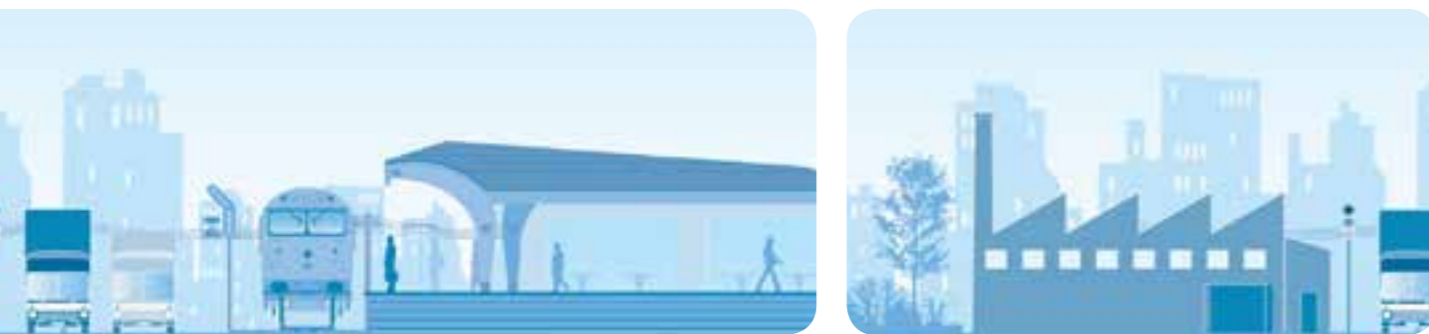

Water management solutions

Roof to River

Offering a comprehensive range of standalone and modular SuDS products, rainwater harvesting and surface water treatment solutions, plus legislative and technical support services, our water management solutions team address the requirements of every construction and civil engineering project.

Carbon efficient solutions

Sustainable indoor environments

Ever stricter building regulations and an increasing number of environmentally conscious customers are driving the demand for greener building products and technologies. We fulfill this demand with a full range of systems that enable collection, transmission, emission and control in heating, ventilation and cooling systems.

Sector focus

Our product systems respond directly to sector-specific requirements thanks to focused Technical and Development Teams with hands on expertise in the following areas:

Civils and infrastructure

Delivering performance and sustainability, our surface water drainage and cable management systems, supported by our in-house Fabrications Team, offer civils and infrastructure project planners a complete suite of solutions.

Residential

We offer the broadest range of residential product and service solutions for both new build and RMI applications, as well as innovative solutions in response to legislative and industry targets for more sustainable housing.

Commercial

Major commercial projects from car parks and high rise office blocks to hospitals, educational premises and shopping centres have all benefited from our range of value engineered products and comprehensive service support.

Literature

All of our literature is available at www.polypipe.com/toolbox

Product literature



Solutions literature



Market sector literature

All of our literature is available at www.polypipe.com/toolbox

Additional market sector literature is available, please visit www.polypipe.com or contact the telephone numbers appearing under each brochure.

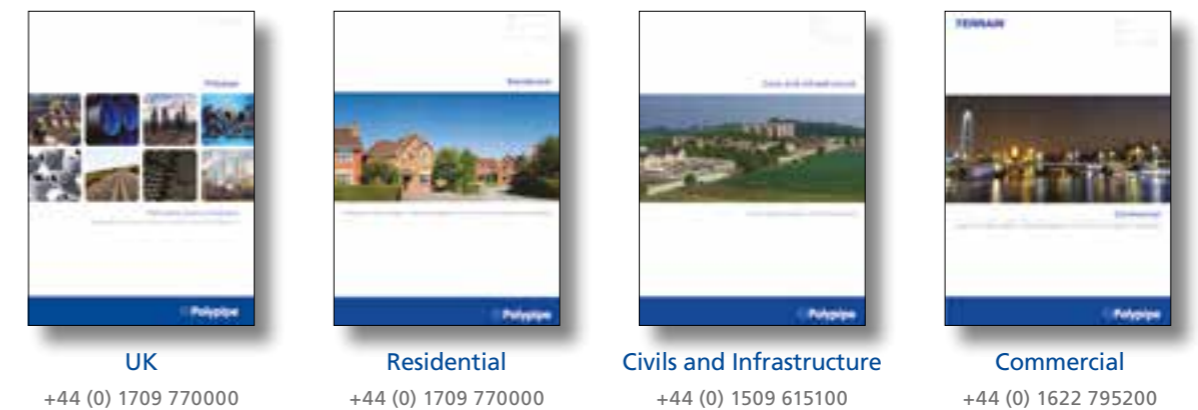

All descriptions and illustrations in this publication are intended for guidance only and shall not constitute a 'sale by description'. All dimensions given are nominal and Polypipe may modify and change the information, products and specifications from time to time for a variety of reasons, without prior notice. The information in this publication is provided 'as is' on May 2016. Updates will not be issued automatically. This information is not intended to have any legal effect, whether by way of advice, representation or warranty (express or implied). We accept no liability whatsoever (to the extent permitted by law) if you place any reliance on this publication you must do so at your own risk. All rights reserved. Copyright in this publication belongs to Polypipe and all such copyright may not be used, sold, copied or reproduced in whole or part in any manner in any media to any person without prior consent. © Polypipe is a registered trademark of Polypipe. All Polypipe products are protected by Design Right under CDPA 1988. Copyright © 2016 Polypipe. All rights reserved.

Civils & Infrastructure

Product Guide



Civils & Infrastructure

Polypipe Civils

Charnwood Business Park
North Road, Loughborough
Leicestershire
LE11 1LE

Tel +44 (0) 1509 615100

Fax +44 (0) 1509 610215

Email civils@polypipe.com

www.polypipe.com/civils



Printed on 100% recyclable chlorine-free paper. All inks used on this brochure are vegetable based.