

# LBS1G4-01

## Individual packaging

Created	2018.03.02	by Jane
Confirmed	2018.03.02	by Robert
Last updated		by
Confirmed		by
Approved	2018.03.02	by Wensi

### 1.Product label

- 1pcs/per product
- Size : 35x35mm

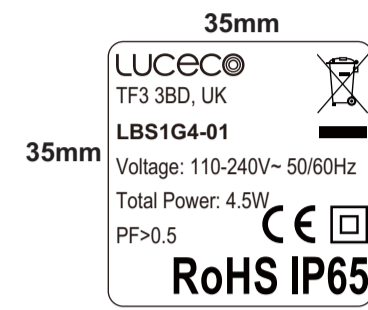

Designed by JX



### 2.Driver label

- 1pcs/per product
- Size : 47x27mm

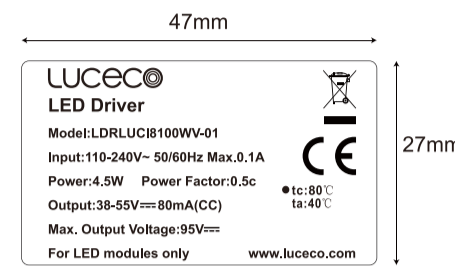

Designed by JX



### 3.Instruction leaflet

- 1pcs/per product
- Size : 210x297mm

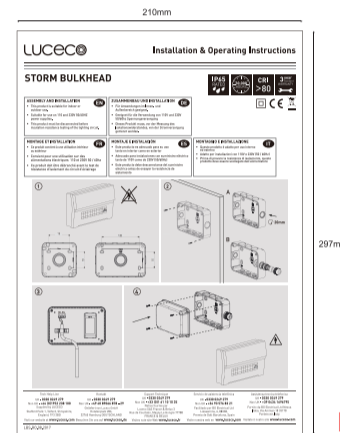

Designed by UK

### 4.Lightning protection warning label

- 1pcs/per product
- Size : 17x15.7mm

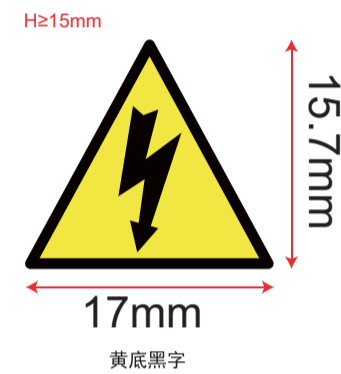

### 5.Individual box

- 1pcs/per product
- Size : 115x80x115mm



Designed by UK

### 6.Energy label

- 1pcs/per individual box
- Size : 385x105mm

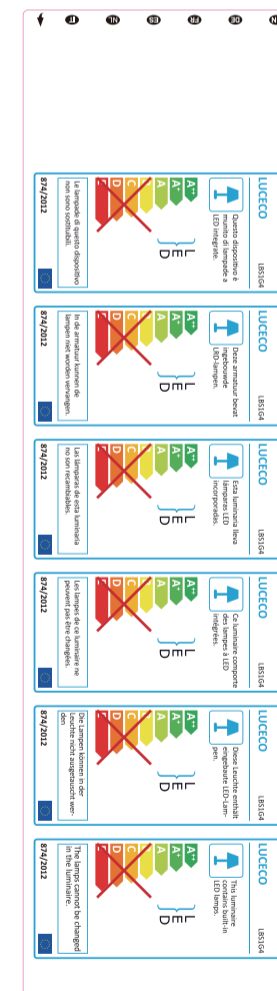

### 7. Batch code label

- 1pcs/per individual color box
- Size : 20x5mm

17W21

The "Date" information needs to be updated every time.  
"17W21" - 2017Y,21<sup>st</sup>Week

### 8. Sealing tap

- 1pcs/per individual color box
- D=30x40mm

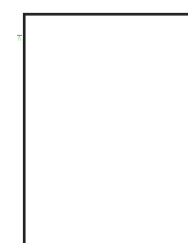

## Outer packaging

Outer qty = 18PCS - 3x3pcs x 2layers

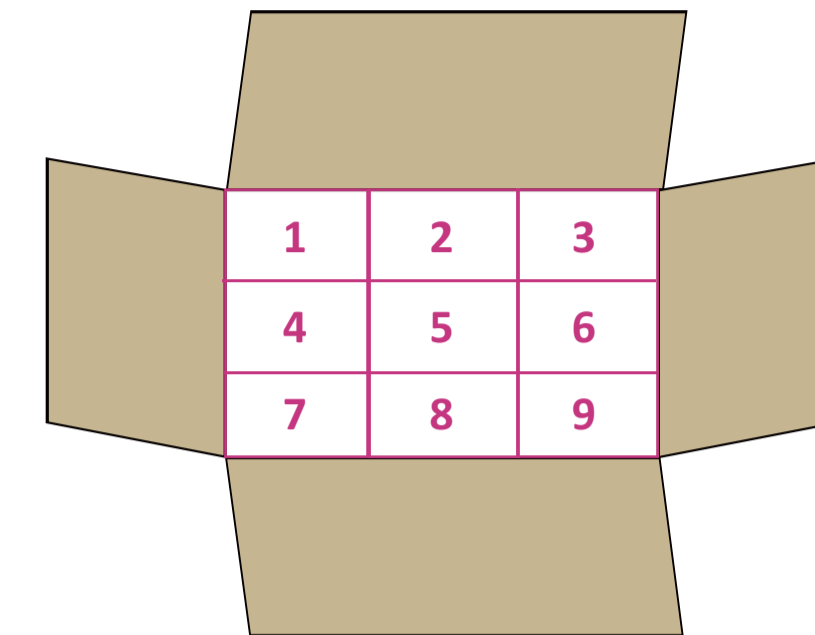

### 9.Outer label

- 2pcs for each shipping box
- SIZE : 100x50mm

LUCECO  
C/NO:

Designed by JX

1. Write "C/NO" on the front mark.
2. Update "Date" information each time.
3. Update "N.W." & "G.W." according to actual products.
4. Update the "Measurement" according to the actual outer carton.

PN.: LBS1G4-01(JX)  
Product Description:  
STORM BULKHEAD 110MM, 400LM, 4.5W,  
4000K, WIDE VOLTAGE DRIVER  
QTY: 18 PCS  
N.W.: 4.43 KG  
G.W.: 5.47 KG  
Measurements: 36x26x25CM  
Date: xxWxx



### 10.Shipping box

- B-Flute Carton box



35mm

LUCECO

TF3 3BD, UK



LBS1G4-01



35mm

Voltage: 110-240V~ 50/60Hz

Total Power: 4.5W

PF>0.5



**RoHS IP65**

47mm



**LUCECO** 

**LED Driver**

**Model:LDRLUCI8100WV-01**

**Input:110-240V~ 50/60Hz Max.0.1A**

**Power:4.5W Power Factor:0.5c**

**Output:38-55V===80mA(CC)**

**Max. Output Voltage:95V===**

**For LED modules only**

**www.luceco.com**



● **tc:80°C**  
**ta:40°C**



27mm

# NEXUS

Note: 请各责任人按照如下要素检查图稿后,方可签字确认。

Updated Details (更新点备注):

Version (现行版本): V1

产品参数

产品工程师

V2

产品型号

包装工程师

V3

条码等级/条码数字

包装工程师

V4

Lightning protection warning  
H≥15mm

15.7mm



17mm

黄底黑字

Product Item Code  
物料料号

RGED032825

Description  
产品名称

Slim FloodLight防雷警告标贴

Material 材质	Type 类别	纸质不干胶	Printing 印刷方式	<input type="checkbox"/> 柔印 <input checked="" type="checkbox"/> 胶印 <input type="checkbox"/> 丝印	ECT 边压强度	N/A	Artworker 设计人	Jeremy.Yang	Date 制作日期	2016.05.27
	Gram Weight 克重	N/A	Surface Treatment 表面处理	<input type="checkbox"/> 上油 <input type="checkbox"/> 哑光 <input type="checkbox"/> UV <input checked="" type="checkbox"/> 亮膜 <input type="checkbox"/> 磨膜	BST 耐破强度	N/A	Confirmed By 确认人	Robert.Walker	Date 确认日期	2016.05.27
	Special Requirement 特别要求	<input type="checkbox"/> 普通国产胶, 300#(白胶) + 阿顿胶(保版) (400克/瓦楞) <input type="checkbox"/> 特种国产胶, 300#(白胶) + 阿顿胶(保版) + 国 产UV油墨胶(青胶) + 80g胶(底纸(青纸)) <input type="checkbox"/> 特种进口胶, PCT(底纸) + RP37(青胶) (400#-99)(蓝纸) 测试要求: <input checked="" type="checkbox"/> 潮态试验 <input checked="" type="checkbox"/> 3000次试验 (针对产品特殊)	Measurement 尺寸规格	17x15.7mm (公差±0.1)	BCT 抗压强度	N/A	Customer Confirmation 客户确认		Date 确认日期	
			Colour 颜色	C00 M00 Y00 K100 (Pantone Color)	Dimension Error Range 尺寸误差值	± 1mm	NPI Engineer 产品项目工程师	Andy.Hu&Spark.Yu	Date 审批日期	2016.05.27
			Symbol Grade 条码等级要求	N/A	Drawing Scale 图纸比例	1 : 1	Approved By 批准人	Wensi.Zhang	Date 审批日期	2016.05.27

210mm

LUCECO

Installation & Operating Instructions

STORM BULKHEAD

IP65 RATED    30,000 HOURS    CRI >80    3 year standard WARRANTY



**ASSEMBLY AND INSTALLATION** **EN**

- This product is suitable for indoor or outdoor use.
- Suitable for use on 110 and 230V 50/60Hz power supplies.
- This product must be disconnected before insulation resistance testing of the lighting circuit.

**ZUSAMMENBAU UND INSTALLATION** **DE**

- Für Anwendungen im Innen- und Außenbereich geeignet.
- Geeignet für die Verwendung von 110V und 230V 50/60Hz Spannungsversorgung
- Dieses Produkt muss, vor der Messung des Isolationswiderstandes, von der Stromversorgung getrennt werden.

**MONTAGE ET INSTALLATION** **FR**

- Ce produit convient à une utilisation intérieur ou extérieur
- Convient pour une utilisation sur des alimentations électriques 110 et 230V 50 / 60hz
- Ce produit doit être débranché avant le test de résistance d'isolement du circuit d'éclairage

**MONTAJE E INSTALACIÓN** **ES**

- Este producto es adecuado para su uso tanto en interior como en exterior
- Adecuado para instalaciones con suministro eléctrico tanto de 110V como de 230V (50/60Hz)
- Este producto debe desconectarse del suministro eléctrico antes de ensayar la resistencia de aislamiento

**MONTAGGIO E INSTALLAZIONE** **IT**

- Questo prodotto è adatto per uso interno ed esterno
- Adatto per installazioni con 110V e 230V (50 / 60Hz)
- Prima di provare la resistenza di isolamento, questo prodotto deve essere scollegato dall'alimentatore

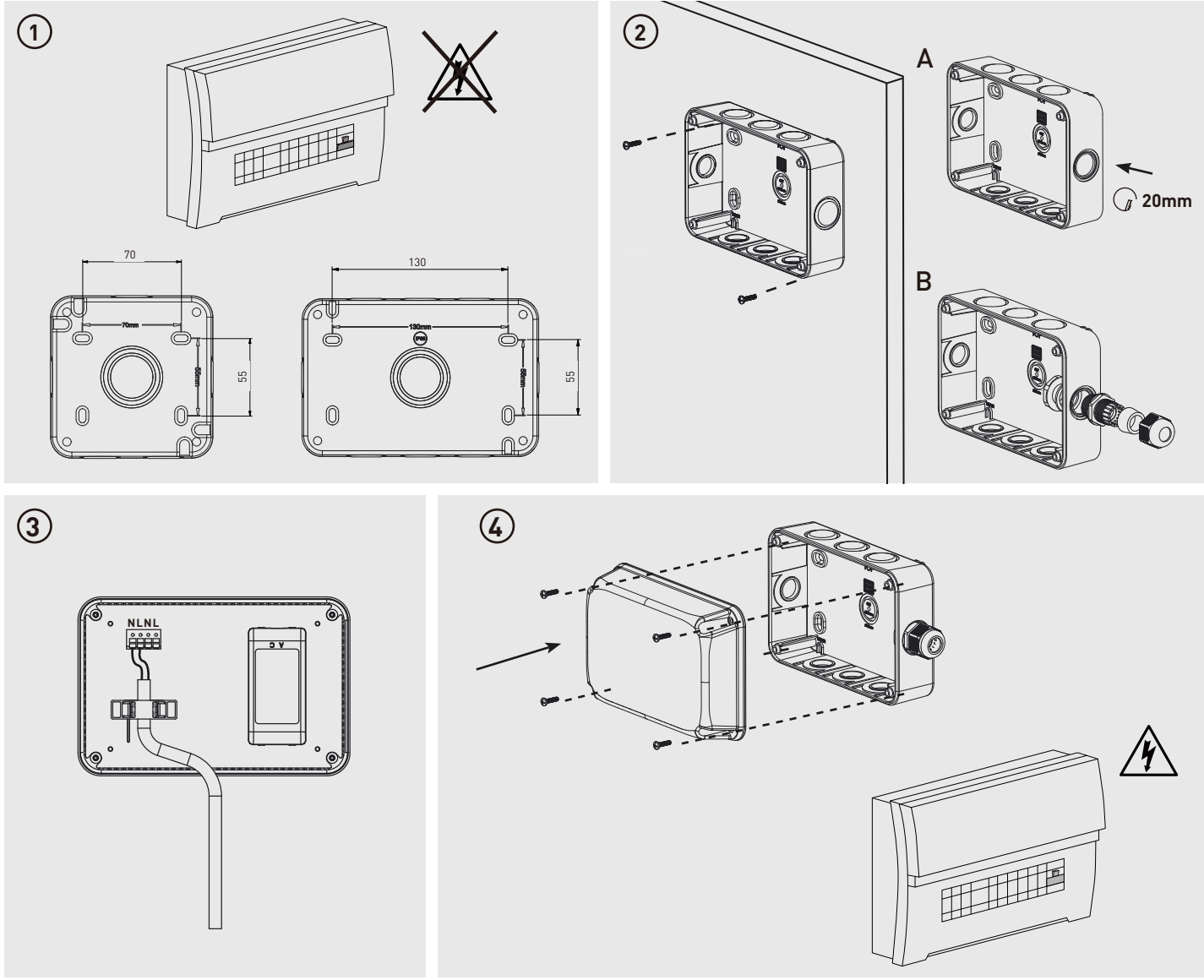

297mm

<p>Tech Help Line UK - 0330 0249 279 Non UK - +44 (0)1952 238 100 Supplied by LUCECO Stafford Park 1, Telford, Shropshire, England, TF3 3BD</p>	<p>Kontakt UK - 0330 0249 279 Non UK - +49 40 89066 878 - 29 Geliefert von Luceco GmbH Holstenplatz 20b, 22765 Hamburg DEUTSCHLAND</p>	<p>Support Technique UK - 0330 0249 279 Non UK - +33 (0)1 61 10 10 35 Notice fournie par Luceco SAS France &amp; Belux 3 Rue de Courtalin, Magny Le Hongre 77700 FRANCE &amp; BELUX</p>	<p>Servicio de asistencia telefónica UK - 0330 0249 279 Non UK - +34 93 576 83 21 Facilitado por BG Electrical Ltd Liessamins, 6, 08338, Premia de Dalt Barcelona, Spain</p>	<p>Assistenza tecnica telefonica UK - 0330 0249 279 Non UK - +39 0434 1696795 Fornito da BG Electrical Ltd Nexus Italia, Via Amman 10 33170 Pordenone, Italy</p>
---	--	---	--	--

Visit our website at [www.luceco.com](http://www.luceco.com) Besuchen Sie uns auf [www.luceco.de](http://www.luceco.de) Visitez notre site Web [www.luceco.fr](http://www.luceco.fr) Visite nuestra web en [www.luceco.com](http://www.luceco.com) Visitate il nostro sito [www.luceco.com](http://www.luceco.com)

35/0/100/0

# LBS1G4-01 STORM SQUARE

IN PROCESS RO.13.02.18  
FINAL RO.14.02.18

## STORM SQUARE IP65 LED BULKHEAD



### FEATURES & BENEFITS

- Impact Resistant Polycarbonate housing
- Speed fit push terminals
- Suitable for use with 110V and 230V power
- Multiple Ø20mm conduit cable entry positions

### SUITABLE APPLICATIONS

- Suitable for residential and commercial outdoor and indoor use
- Ideal replacement for 60W A60 bulkhead

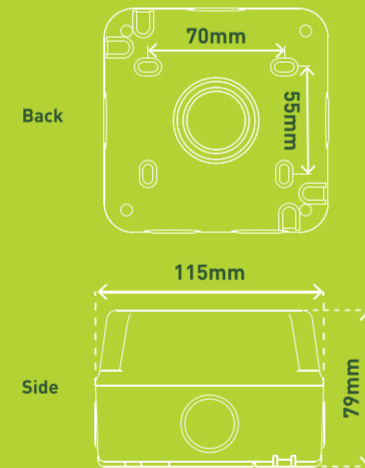

LBS1G4



PLACE ENERGY LABEL STICKER HERE THIS WAY UP

## LUCECO STORM SQUARE IP65 LED BULKHEAD



LBS1G4

## STORM SQUARE IP65 LED BULKHEAD

FR - HUBLOT LED IP65 CARRÉ  
 DE - STORM LED WAND- UND DECKEN-AUSSENLEUCHTEN, IP65, QUADRATISCH  
 ES - APLIQUE ESTANCO CUADRADO LED IP65 - STORM  
 IT - QUADRATO IMPERMEABILE IP65 - STORM

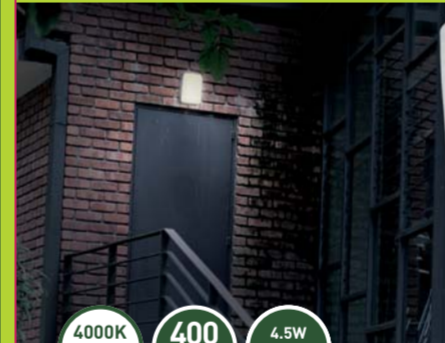

LBS1G4



## STORM SQUARE IP65 LED BULKHEAD



LBS1G4

Supplied by LUCECO  
 Stafford Park 1, Telford  
 Shropshire, England  
 TF3 3BD  
 www.luceco.com



80mm

115mm

115mm

Size:385x105mm

EN

DE

FR

ES

NL

IT



**LUCECO** LBS1G4

 Questo dispositivo è munito di lampade a LED integrate.

 } LED

Le lampade di questo dispositivo non sono sostituibili.

874/2012 

**LUCECO** LBS1G4

 Deze armatuur bevat ingebouwde LRD-lampen.

 } LED

In de armatuur kunnen de lampen niet worden vervangen.

874/2012 

**LUCECO** LBS1G4

 Esta luminaria lleva lámparas LED incorporadas.

 } LED

Las lámparas de esta luminaria no son recambiables.

874/2012 

**LUCECO** LBS1G4

 Ce luminaire comporte des lampes à LED intégrées.

 } LED

Les lampes de ce luminaire ne peuvent pas être changées.

874/2012 

**LUCECO** LBS1G4

 Diese Leuchte enthält eingebaute LED-Lampen.

 } LED

Die Lampen können in der Leuchte nicht ausgetauscht werden

874/2012 

**LUCECO** LBS1G4

 This luminaire contains built-in LED lamps.

 } LED

The lamps cannot be changed in the luminaire.

874/2012 

100x50mm

**LUCEEC** ©

**C/NO:**

100x50mm

**PN.: LBS1G4-01(JX)**

**Product Description:**

**STORM BULKHEAD 110MM, 400LM, 4.5W,  
4000K, WIDE VOLTAGE DRIVER**

**QTY: 18 PCS**

**N.W.: 4.43 KG**

**G.W.: 5.47 KG**

**Measurements: 36x26x25CM**

**Date: xxWxx**



5 015056 585024 >