

Birtley

BIRTLEY LINTELS PRODUCT GUIDE

The **only** lintel range to **guarantee**
complete and consistent protection

0330 404 9951
www.birtleylintels.co.uk

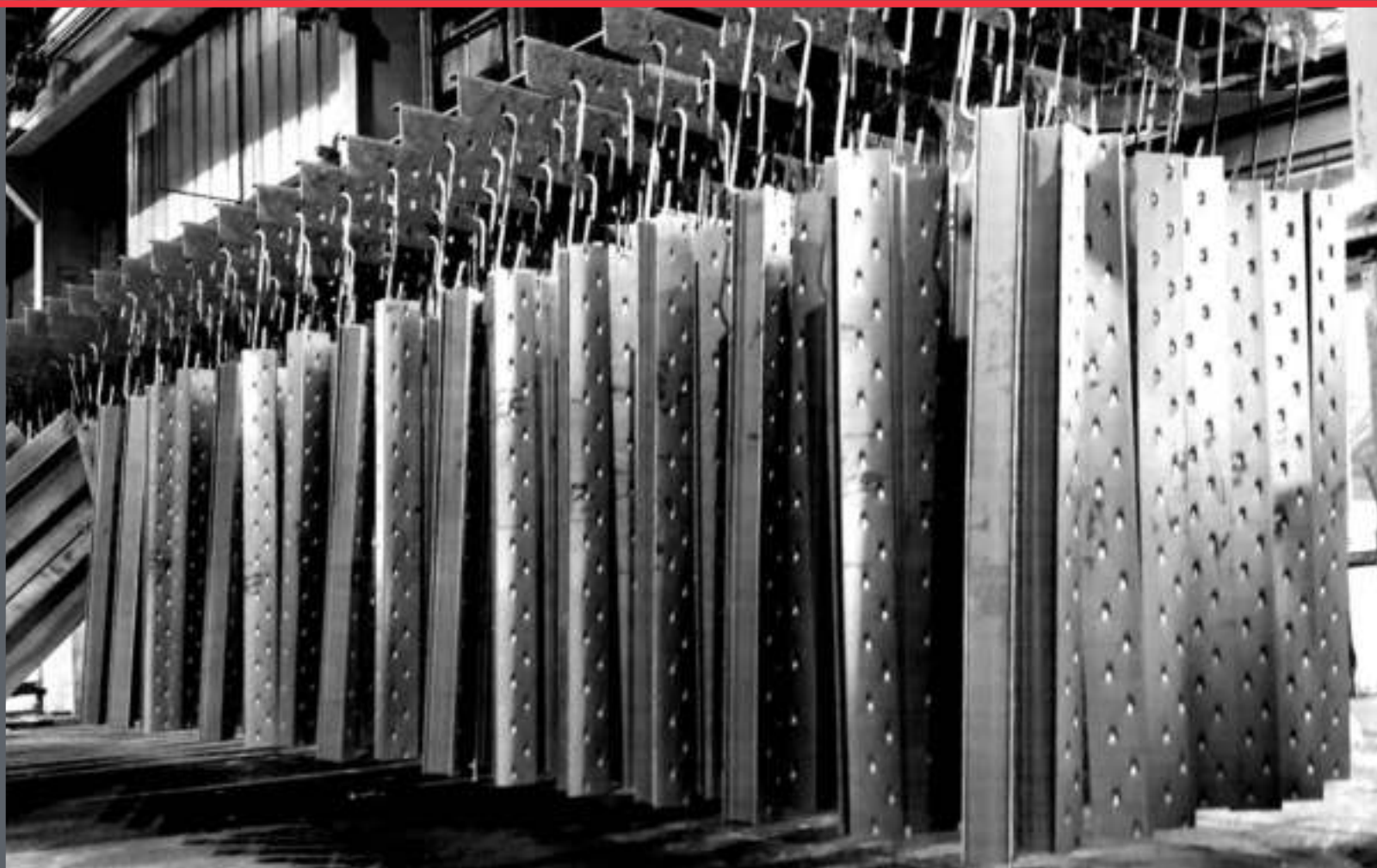



“ CONSTRUCTION IS
THE ART OF MAKING A
MEANINGFUL WHOLE
OUT OF MANY PARTS ”

- Peter Zumthor (Architect)

BIRTLEY LINTELS – Supporting the UK construction industry since 1965

Founded in 1965 in County Durham, Birtley began life as a small structural steel business, opening on 19th July that year.

Originally steel fabricators for the mining industry, Birtley added steel lintels to its product range in 1967 and by 1979 was a credible building industry specialist, with depots across the country. In 1996, Birtley commissioned and built a brand new plant, establishing one of

Europes most advanced facilities for hot dipped galvanizing which remains fully operational today.

Birtley acquired the metalwork manufacturer Expamet in 2012, followed by an acquisition of Bowater Doors in 2015. All three companies now operate under the Birtley Group banner, providing a broad spectrum of products to the construction industry.

CONTENTS

TECHNICAL SUPPORT

- 06 Commitment to Quality
- 07 Advisory Service
- 08 Zinc Millenium Map
- 09 Coatings Compared
- 10 Building Regulations
- 13 Thermal Performance

PRODUCT SELECTOR

- 15 Lintel Selector
- 16 Product Range
- 18 Thermically Broken Lintels

CAVITY WALL LINTELS

- 20 Supatherm Lintel Options
- 21 Supatherm Lintel Range
- 22 50mm Cavity Wall Lintels
- 25 70mm Cavity Wall Lintels
- 28 90mm Cavity Wall Lintels
- 31 110mm Cavity Wall Lintels
- 34 130mm Cavity Wall Lintels
- 37 150mm Cavity Wall Lintels

LINTEL RANGE

- 40 Solid Wall Lintels
- 41 External Wall Lintels
- 42 Internal Wall & Box Lintels
- 43 Eaves Lintels
- 44 Timber Frame Lintels
- 45 Lintel Options
- 46 Bespoke Designs
- 48 Balconies
- 49 Accessories
- 50 Masonry Support

USEFUL INFORMATION

- 52 Installation
- 53 Health & Safety
- 54 Compliance
- 55 Glossary

Need technical advice?

Speak to our technical team

0330 404 9951

lintel.technical@birtleygroup.co.uk



The Birtley logo is displayed in a white rectangular box with a thin black border. The word "Birtley" is written in a bold, black, sans-serif font. A small red triangle is positioned above the letter 'i'.

**CAN'T FIND WHAT
YOU'RE LOOKING FOR?**

SPEAK TO ONE OF OUR CUSTOMER ADVISORS

Sales & Technical

0330 404 9951

intel.sales@birtleygroup.co.uk
intel.technical@birtleygroup.co.uk

Birtley is the **only intel range** that **guarantees complete and consistent protection**. On top of our **industry-leading performance**, you'll also enjoy the **unlimited support** of our entire technical team, **free of charge**.



Industry leading
performance



Free of charge
support team



Quick
turnaround



Custom-made
solutions



Downloadable
technical information

OUR COMMITMENT TO QUALITY

**Need technical
advice?**

Speak to our technical team
0330 404 9951

Our Commitment to Quality

With over 50 years of manufacturing expertise Birtley continues to be the stalwart of the lintel market, producing over 25,000 tonnes of steel products for the construction sector every single year.

Understated Strength

Birtley is the only lintel manufacturer to hot-dip galvanize after fabrication providing up to 50% more zinc protection than other approved coatings. Hot Dip Galvanizing to EN1461 offers superior corrosion protection and lifespan compared with pre-galvanized steel. We offer a 65-150µm zinc coating thickness to suit life expectancy and exposure class. Our lintels are the only lintels to deliver consistent protection to all parts including welds and cuts, which are otherwise only protected by paint on pre-galvanized alternatives.



**GALVANIZERS
ASSOCIATION**



TECHNICAL SUPPORT ADVISORY SERVICE

Can't find what
you're looking for?

Speak to our technical team
0330 404 9951

Our Services

Birtley provides comprehensive technical support to designers, specifiers, builders and merchants covering all aspects of the design, specification and installation of Supergalv lintels. The service includes :

- Technical Support**
Comprehensive pre- and post-sale technical support by phone or email.
- BIM**
Parametric Revit Models with 3D previews.
- CAD Scheduling**
Free specification and CAD scheduling service when architectural plans are supplied.
- Unusual Applications**
Advice and solutions for unusual loading situations.
- Design Service**
Lintel design service for bespoke architectural features and wall constructions.
- Calculations**
Structural calculations, when necessary, for building control approval.
- Ψ PSI Values**
Bespoke accredited linear thermal transmittance Ψ (Psi values) for use in SAP calculations.
- Structural Analysis**
Finite Element Analysis of complex structures.

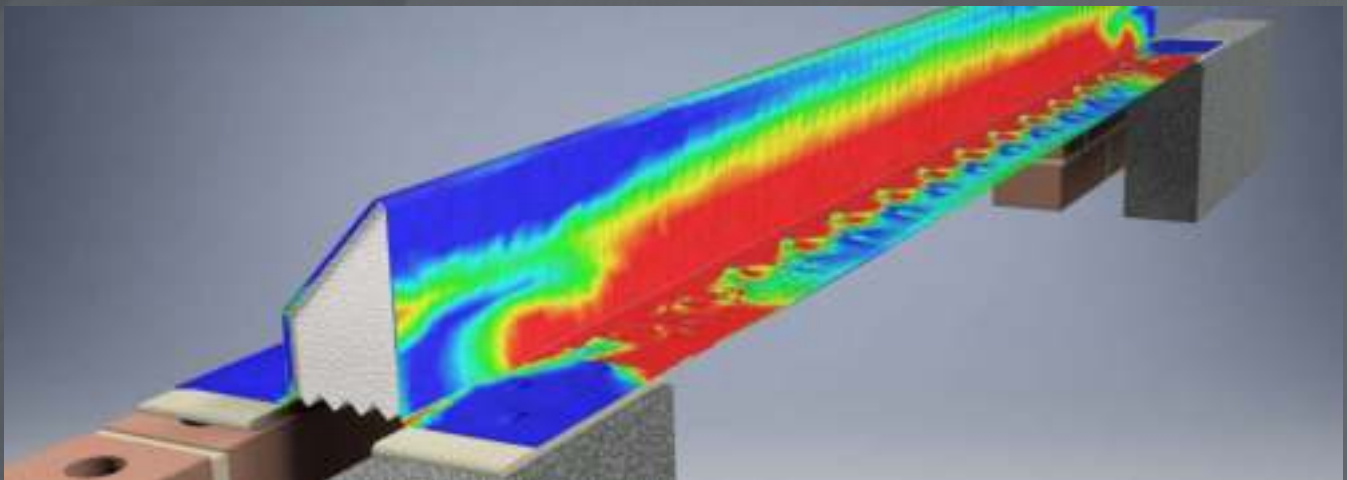

In order to provide you with a faster and more reliable scheduling service, the following details will help us to give you an exact recommendation:

- Drawings**
CAD, PDF or Fax: preferably 1:50 scale, including plans, sections and elevations.
- Wall Details**
Solid/cavity wall dimensions, materials and density if non-standard.
- Floor Details**
Timber/concrete, direction of span, and loadings (if concrete).
- Roof Layout**
Including location of girder trusses and calculations if available.

KEY CONSIDERATIONS GALVANIZERS ASSOCIATION

**Need technical
advice?**

Speak to our technical team
0330 404 9951

The life of any coating is dependent on the local environment, which is often hard to quantify. The Galvanizers Association is responsible for a nationwide scientific survey which links geographic location to the lifespan of a galvanized coating.

Atmospheric corrosion rate of hot dip galvanizing

This is an approximate guide and is most relevant to stationary, exterior exposed structures. Any site specific factors which may affect the corrosion rate must also be taken into account.

Detailed data for individual sites and advice on its interpretation (e.g. the possible effects of a local micro-climate on the corrosion rate actually experienced by the galvanized structure) is available from the Galvanizers Association.

How to use the map

- Locate your project on the map
- Match the colour of the square to the key
- Read off the average background corrosion rate in μm per annum
- Divide the coating thickness by the corrosion rate to obtain the expected minimum life of the galvanized coating, or just use the following table.

Corrosion Category	0.5	1	1.5	2	2.5
Average Corrosion rate ($\mu\text{m}/\text{year}$)	0.5	1	1.5	2	2.5
Supergalv 65 μm min life expectancy (years)	130	65	43	33	26
Ultragalv 150 μm min life expectancy (years)	300	150	100	75	65

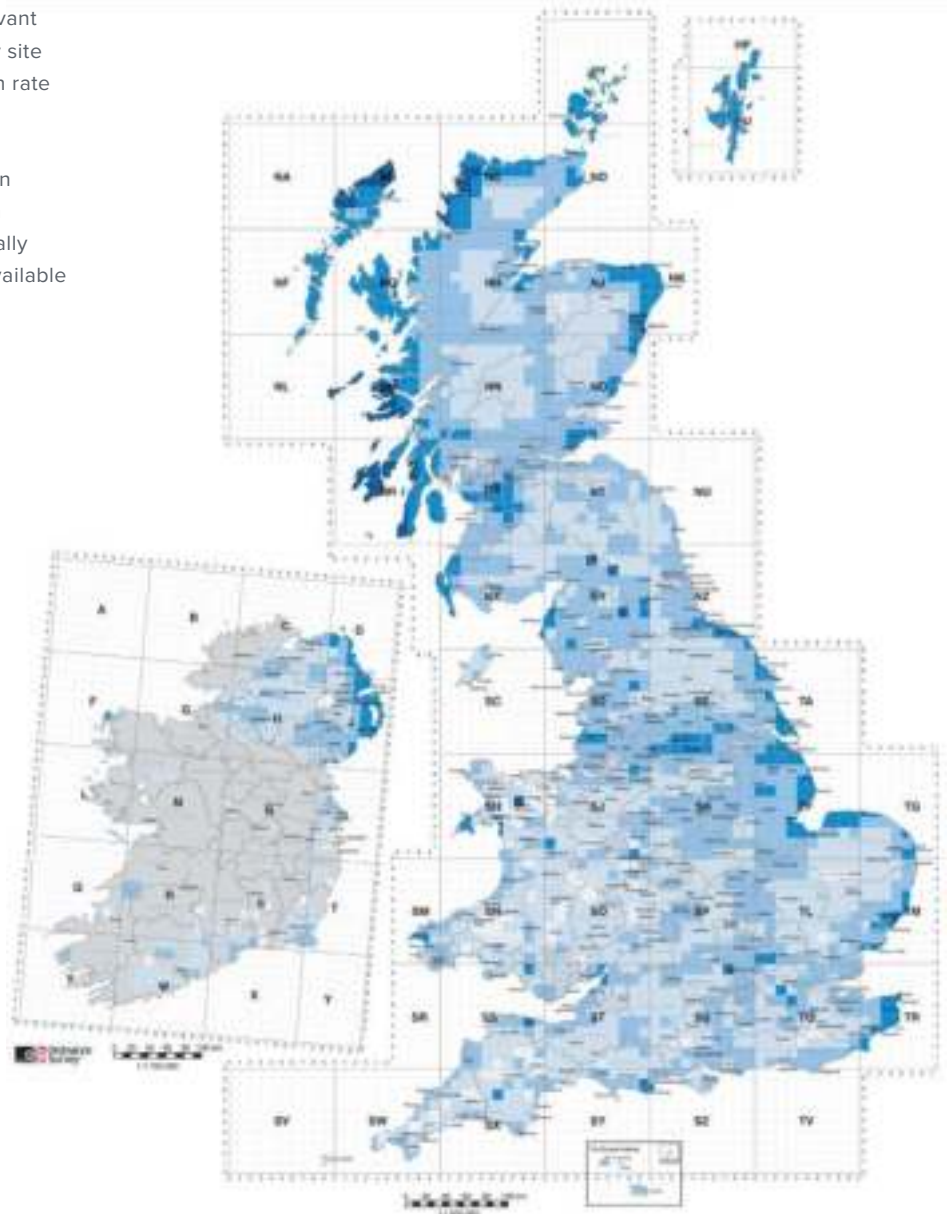

**GALVANIZERS
ASSOCIATION**

Based upon the annual average atmospheric corrosion of Zinc, UK and Republic of Ireland, 1998-2000.

KEY CONSIDERATIONS COATINGS COMPARED

Can't find what
you're looking for?

Speak to our technical team
0330 404 9951

Our post fabrication dipping process ensures that every part of every lintel is covered with an equally effective layer of protection. Other lintels are often made using pre-galvanized material, which is cut, bent and processed before a layer of paint is used to protect the cut surfaces, the same surfaces which are at the greatest risk of damage. Our cut edges are protected by metal, not paint, that's why Birtley lintels are far more durable than other products on the market.

EN 845-2 Coatings Compared

Within EN845-2, several material coatings are deemed suitable for use when manufacturing lintels for the UK market. The following scale diagrams show how we compare with other hEN approved systems of corrosion protection:



BASIC

Paint only on cut edges

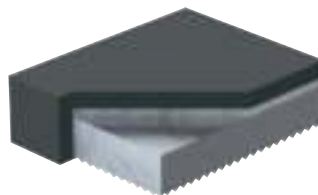

DUPLEX

Paint only on cut edges

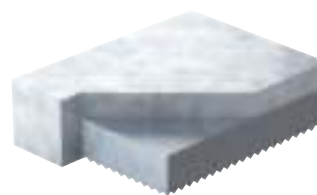

BIRTLEY STANDARD

Fully protected edges

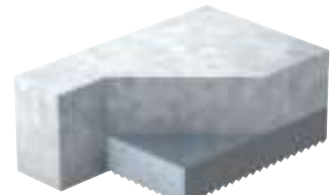

BIRTLEY ULTRAGALV

Fully protected edges

	BASIC	DUPLEX	BIRTLEY STANDARD	BIRTLEY ULTRAGALV
Coating	Pre-galvanized steel strip with coated edges	Pre-galvanized steel strip with coating all over	Fully galvanized	Shot blasted & fully galvanized
Zinc Thickness	42 Microns	19 Microns	65 Microns	150+ Microns
Life Expectancy	28 Years	Dependent on condition	43 Years	100+ Years

Coating Life Expectancy

The graph opposite shows how long you would expect each galvanized coating to last in a moderate 1.5µm/year corrosion rate as defined by the map overleaf. The difference speaks for itself.

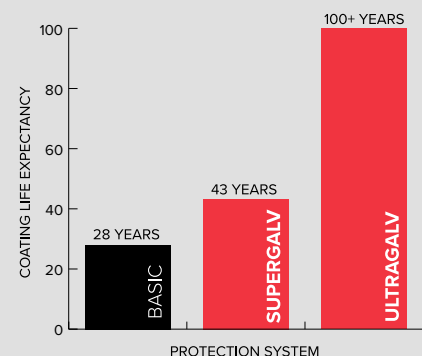

PRODUCT SPECIFICATION BUILDING REGULATIONS

**Need technical
advice?**

Speak to our technical team
0330 404 9951

Material Specification

Birtley has the only complete range of steel lintels manufactured from structural grade steels: S275JR/S355JR to EN10025- 2:2004. All Supergalv lintels are Hot-Dip Galvanized, post fabrication, in accordance with BS EN 1461:2009, giving an unrivalled 65µm zinc coating to all surfaces.

Whilst our standard coating is suitable for the vast majority of applications, coastal regions need special consideration. An additional soffit cover, paint-finish (to ISO 12944) or a stainless steel lintel should be specified where a site is in an exposed coastal location. For NHBC sites, coastal exposure is deemed to be within 500m of the shoreline.

Galvanized Lintel



Stainless Steel Lintel



Stainless steel lintels are made to order using 1.4301 (304) austenitic stainless steel to BS EN 10088-1:2014. Other grades can be specified on request. Polyester powder coating of lintels to standard RAL colours is available by special order. POA.

Insulation

All external cavity wall lintels (exc SX/XHD) are insulated with expanded polystyrene to BS EN 13163. The insulation is CFC, HCFC and HFA free and has an ozone depletion potential of zero. Expanding with pentane achieves a BREEAM credit for a global warming potential of zero. The underside of the insulation is profiled to act as an efficient plaster key, with the absence of a baseplate preventing a cold-bridge occurring at the window head.

Thermal Performance

Linear Thermal Transmittance Ψ (Psi) values are calculated by engineers qualified to design Accredited Construction Details for use in SAP 2012. Calculations are undertaken using Heat 2/3 software, validated to EN ISO 10211/EN ISO 10077-2, and in accordance with BRE documents IP 1/06 and BR497. Our in-house team of Accredited Thermal Modellers will carry out bespoke thermal bridging assessments on request.

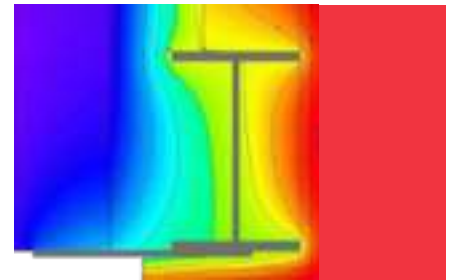

Fire Resistance

Birtley lintels have been tested to BS 476-20:1987 to determine the fire resistance of the load bearing elements of construction. A minimum 60min rating is achieved when installed with a plaster finish. We are happy to provide test reports on request.



PRODUCT SPECIFICATION BUILDING REGULATIONS

Can't find what
you're looking for?

Speak to our technical team
0330 404 9951



Structural Performance

All structural data included within this guide has been derived by calculation, Finite Element Analysis, and physical testing in accordance with BS EN 845-2:2013, BS 5977-2:1983, BS EN 1993+NAs. All declared loads are assumed to be uniformly distributed and are based on serviceability limit state design. Loads are limited by a 1.6 factor of safety against structural failure, and a deflection limit of $L_{eff}/325$, where L_{eff} is the distance between bearing centres. Load ratios are provided to ensure that the lintel cannot be overstressed within the maximum declared load. Ratios outside of those stated can be accommodated, although the maximum safe load may no longer apply. Similarly a non-uniform load distribution could lead to an increase or decrease in load capacity. Please contact our Technical Department for further information.

CB	CBHD	MD, HD, HDX, SX, XHD
Standard Duty	Medium Duty	Medium/Heavy Duty
1:1 to 1:3	1:1 to 1:5	1:5 to 1:19

PRODUCT SPECIFICATION THERMAL PERFORMANCE

Need technical
advice?

Speak to our technical team
0330 404 9951



SUPATHERM FOR HEROIC STRUCTURES

TYPICAL ψ VALUE 0.03 - 0.06

A NEW CHAMPION OF **THERMAL BRIDGING SOLUTIONS**

A new construction hero has arrived to help you achieve energy efficiency without compromising on design.

- Over 75% reduction in heat loss compared to standard lintels.
- Custom shapes, arches and various flange options on request.
- All parts and assemblies CE marked to BS EN 845-2.

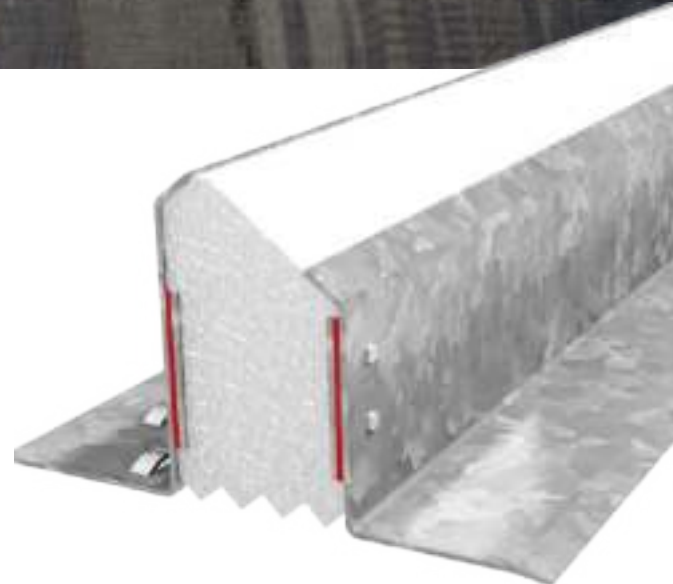

**Turn to page 21
to view the full
Supatherm
product range**

PRODUCT SPECIFICATION THERMAL PERFORMANCE

Can't find what
you're looking for?

Speak to our technical team
0330 404 9951

Thermal Bridging

Lintels are classed as non-repeating thermal bridges and have an associated heat loss which is quantified as a Ψ (Psi) Value. Psi values are measured in Watts/Metre*Kelvin, therefore the lower the value, the less heat is lost through the junction.

The Building Regulations: Approved Documents L1A/L2A & SAP

Recent changes in the Building Regulations mean that a building's fabric performance must now hit a Target for Fabric Energy Efficiency (TFEE) in addition to the traditional Target Emission Rate (TER) for CO₂. This means that more emphasis is put on reducing heat loss, a significant proportion of which can be attributed to lintels and other non-repeating thermal bridges.

A 'recipe' based system is adopted by SAP 2012 whereby a notional dwelling of identical proportions is given set values of linear thermal transmittance from Appendix R. These values aren't intended to limit each individual junction or wall, but when combined with other factors and U values, form a target for the dwelling as a whole. Appendix R values are significantly lower than approved values from Appendix K so it is important that energy assessors use dwelling specific accredited values; otherwise they may be forced to over-compensate in other aspects of fabric specification.

CB90		
Length Range	Psi Value*W/mK	Temperature Factor
750-1050	0.171	0.942
1200-1350	0.169	0.904
1500-1650	0.195	0.937
1800-2100	0.186	0.901
2250-2400	0.210	0.891
2550	0.203	0.897
2700-3000	0.197	0.903
3300-3900	0.217	0.897

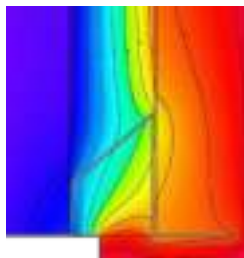

MD90		
Length Range	Psi Value*W/mK	Temperature Factor
1800	0.199	0.75



HD90		
Length Range	Psi Value*W/mK	Temperature Factor
1800	0.183	0.82



Accredited Construction

Building to a Part L Accredited Construction Detail allows energy assessors to use an approved value of 0.3W/mK for lintels without a baseplate; in reality, our lintels can perform significantly better.

The values opposite show the actual calculated heat loss, for standard, medium and heavy duty lintels in a 100mm cavity wall. For other wall constructions, lengths or conductivities, please contact our Technical Department for further guidance.

Temperature Factors should be in excess of 0.75 to minimise the risk of mould growth.

Talk to us today
for advice on thermal
bridging solutions

0330 404 9951

* Actual calculated values based on 100mm cavity, full fill insulation. Block $\lambda=0.19$.



HOW TO SELECT A BIRTLEY LINTEL

Can't find what you're looking for?

Speak to our technical team
0330 404 9951

1 Step One: Wall Construction

How is the wall constructed?

Cavity Wall:

Measure the inner leaf thickness, cavity width & outer leaf thickness. Birtley recommends the use of an additional cavity tray with all external cavity wall lintels.

Solid Walls:

Available for • Single leaf face brick or block external walls.

- 200-215mm solid brick or block walls.
- 215mm fair face solid walls with two leaves.

Internal Walls:

Available for • 100mm and 140mm load bearing walls

- 100mm Non-load bearing walls

Timber Frames:

Measure the cavity width & the outer leaf thickness.

2 Step Two: Opening

How wide is the opening?

Measure: The opening that will contain the window or door.

The Lintel: Should be minimum 300mm wider than the opening (150mm at each end) Except when noted otherwise.

3 Step Three: Loading

How much weight is above the opening?

To determine which load duty is required, the imposed load must be fully assessed and quantified.

Loads can be direct e.g. walls/floors/live loads, or indirect, from adjacent parts of the structure - for which a proportion must be taken into account. Imposed loads should be derived in accordance with PD6697/BS5977, and unfactored when compared with our published Safe Working Loads (SWL).

LINTEL RANGE CAVITY WALLS

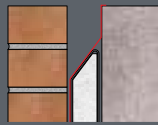

100MM OUTER LEAF / 100MM INNER LEAF

Measure the inner leaf thickness, cavity width & outer leaf thickness.

CAVITY SIZE	Standard Duty	Standard/ Medium Duty	Medium Duty	Heavy Duty	Extra Heavy Duty	Ultra Heavy Duty	Extreme Heavy Duty
50-65mm	CB50	CB50HD	MD50	HD50	HDX50	SX50	XHD50
70-85mm	CB70	CB70HD	MD70	HD70	HDX70	SX70	XHD70
90-105mm	CB90	CB90HD	MD90	HD90	HDX90	SX90	XHD90
110-125mm	CB110	-	MD110	HD110	HDX110	SX110	XHD110
130-145mm	CB130	-	MD130	HD130	HDX130	SX130	XHD130
150-165mm	CB150	-	MD150	HD150	HDX150	SX150	XHD150



100MM OUTER LEAF / WIDE INNER LEAF

Measure the inner leaf thickness, cavity width & outer leaf thickness.

CAVITY SIZE	Standard Duty	Medium Duty	Heavy Duty	Extra Heavy Duty	Ultra Heavy Duty	Extreme Heavy Duty
50-65mm	CB50/130	MD50/130	HD50/130	HDX50/130	SX50/130	XHD50/130
70-85mm	CB70/130	MD70/130	HD70/130	HDX70/130	SX70/130	XHD70/130
90-105mm	CB90/130	MD90/130	HD90/130	HDX90/130	SX90/130	XHD90/130
110-125mm	CB110/130	MD110/130	HD110/130	HDX110/130	SX110/130	XHD110/130
130-145mm	CB130/130	MD130/130	HD130/130	HDX130/130	SX130/130	XHD130/130
150-165mm	CB150/130	MD150/130	HD150/130	HDX150/130	SX150/130	XHD150/130



WIDE OUTER LEAF / 100MM INNER LEAF

Measure the inner leaf thickness, cavity width & outer leaf thickness.

CAVITY SIZE	Standard Duty	Medium Duty	Heavy Duty	Extra Heavy Duty	Ultra Heavy Duty	Extreme Heavy Duty
50-65mm	CB125/50/100	MD125/50/100	HD125/50/100	HDX125/50/100	SX125/50/100	XHD125/50/100
70-85mm	CB125/70/100	MD125/70/100	HD125/70/100	HDX125/70/100	SX125/70/100	XHD125/70/100
90-105mm	CB125/90/100	MD125/90/100	HD125/90/100	HDX125/90/100	SX125/90/100	XHD125/90/100
110-125mm	CB125/110/100	MD125/110/100	HD125/110/100	HDX125/110/100	SX125/110/100	XHD125/110/100
130-145mm	CB125/130/100	MD125/130/100	HD125/130/100	HDX125/130/100	SX125/130/100	XHD125/130/100
150-165mm	CB125/150/100	MD125/150/100	HD125/150/100	HDX125/150/100	SX125/150/100	XHD125/150/100

BIRTLEY LINTELS RANGE OVERVIEW

**Need technical
advice?**

Speak to our technical team
0330 404 9951

SOLID WALLS

Page 40

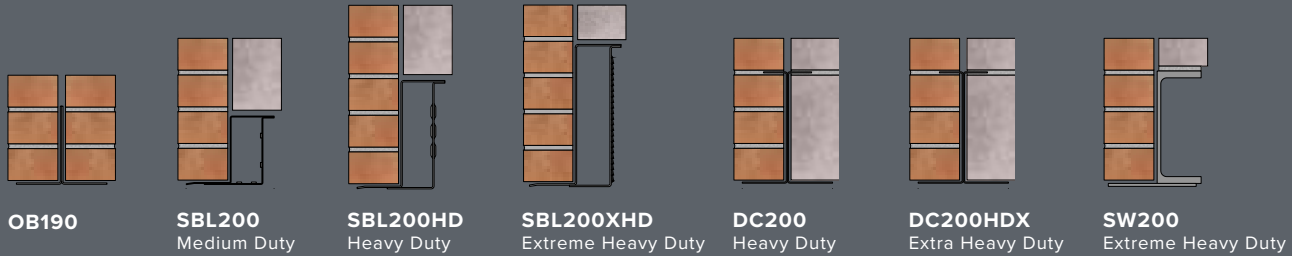

INTERNAL WALLS

Page 43

Non-Loadbearing Walls

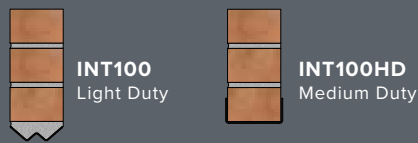

INTERNAL WALLS

Page 42-43

Box Lintels

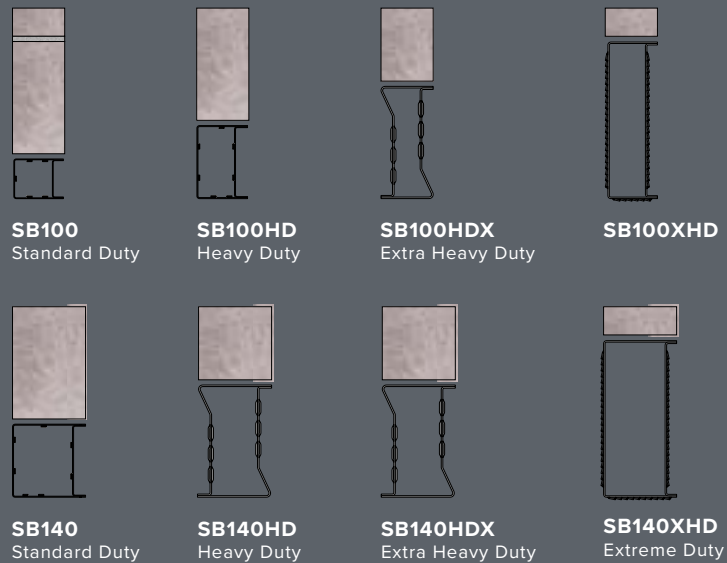

N.B. Profiles shown are indicative and change with length for a given load duty classification. Height of profile illustrated is shown in brackets. Please consult our literature for more information.

EAVES

Page 43

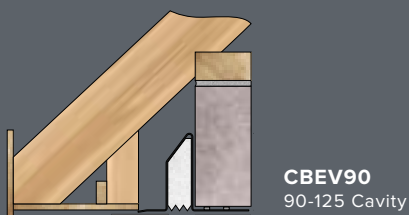
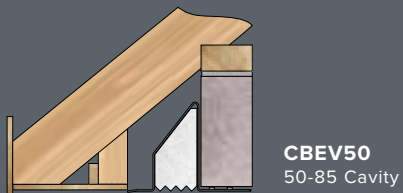

TIMBER FRAME

Page 44

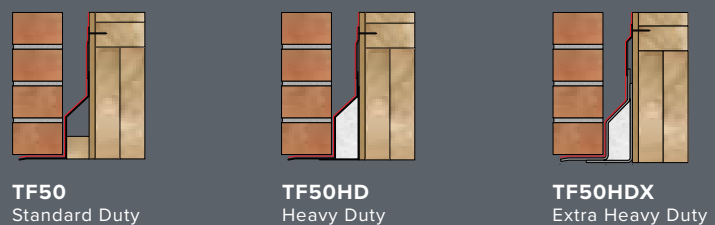

BIRTLEY LINTELS RANGE OVERVIEW

Can't find what
you're looking for?

Speak to our technical team
0330 404 9951

EXTERNAL WALLS

Page 41



MBL
Light Duty



LA
Standard Duty



LAHDX
Extra Heavy Duty



LAXHD
Extreme Heavy Duty



EV100
Standard Duty



EV100HDX
Extra Heavy Duty



EV100XHD
Extreme Heavy duty

MITRES AND CURVES

Page 47

Curved
on Plan

N.B. Posts
may be required
for structural
reasons



Other shapes can
be manufactured - Please Ask

Mitred
Bay Lintel

CUSTOM PROFILES

Page 46-47

Standard shapes, made to the
sizes you need.

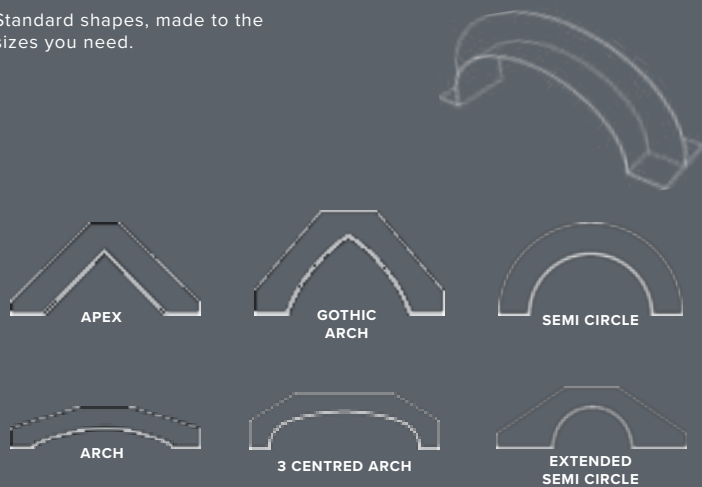

APEX

GOTHIC
ARCH

SEMI CIRCLE

ARCH

3 CENTRED ARCH

EXTENDED
SEMI CIRCLE

JULIET BALCONIES

Page 48



The versatile Birtley range of 'Juliet' Balconies offers eight attractive and practical styles to choose from plus further 'custom-design' options.

ACCESSORIES

Page 49

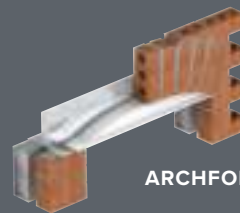

ARCHFORMER

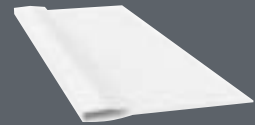

SOFFIT COVER
Decorative PVC cover

Other cavity sizes / masonry options are available (Page 45, 50 & 51)
If the lintel you require isn't shown, please contact us for more information

For free advice please contact our technical team on:

0330 404 9951 | fax: 0191 411 2558

lintel.technical@birtleygroup.co.uk

DID YOU KNOW...

Birtley Group also design and manufacture bespoke masonry support solutions and windposts?
Email info@birtleygroup.co.uk for more information



THERMALLY BROKEN LINTELS SUPATHERM

**Need technical
advice?**

Speak to our technical team
0330 404 9951

BIRTLEY SUPATHERM LINTELS:

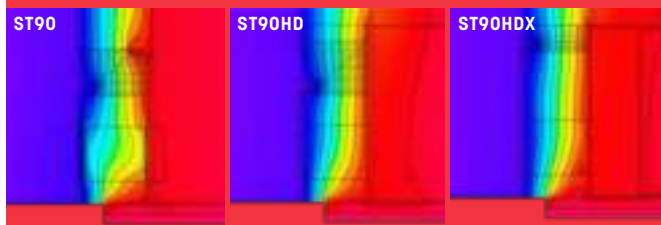

	Length Range	Psi Value*W/mK
ST90	750-1050	0.098-0.057
	1200-1350	0.053-0.048
	1500-1650	0.043-0.039
	1800-2100	0.06-0.052
	2250-2400	0.048-0.043
	2550	0.039
	2700-3000	0.055-0.051
	3300-3900	0.037-0.031
ST90HD	1800	0.04
ST90HDX	1800	0.043

* Actual calculated values based on 100mm cavity, full fill insulation. Block $\lambda=0.45$.

FEATURES & BENEFITS

When more significant fabric savings are needed, our Supatherm range of lintels can reduce heat loss by up to 80% when compared with a standard cavity wall lintel. Based on a typical detached, semi-detached, or terraced property, Supatherm lintels can improve the Dwelling Fabric Energy Efficiency (DFEE) by up to 3%, and the overall Dwelling Emission Rate (DER) by over 1%.

THE RESULT

For a small detached dwelling (105m²), this could mean the difference between double glazing and triple glazing, saving roughly 25% on all windows.

On a large detached dwelling (304m²), it could enable a wall cavity reduction from 150 to 125mm. This creates significant savings in insulation and masonry ancillaries.

TYPICAL Ψ VALUE 0.03 - 0.06

Further details on request

WHY CHOOSE SUPATHERM?

- Up to 80% reduction in heat loss compared with standard cavity wall lintels
- 65 μ m Hot-Dip Galvanized coating to EN1461 as standard
- Options to suit all types of masonry and wall construction
- All parts and assemblies CE marked to BS EN 845-2
- To suit cavity widths from 90 to 150mm
- Lengths available from 750 to 3900mm
- Standard duty, heavy duty and extra heavy duty versions available
- Avoids propping associated with single leaf lintels

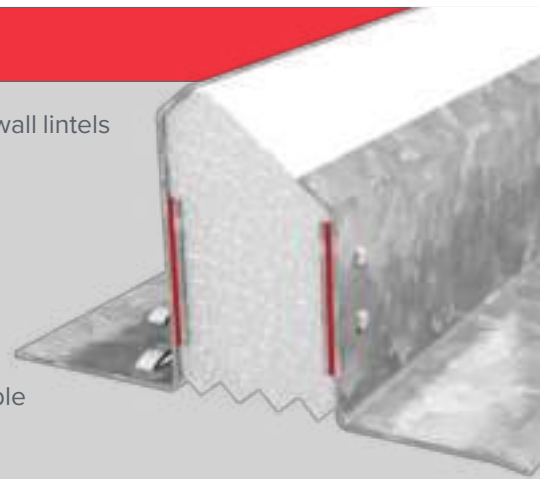

TYPICAL APPLICATIONS:



PARTIAL FILL

100mm cavity, partial fill insulation*, with fire rated cavity closer to underside ST90 1950-2400mm shown
*Partial full insulation requires a suitable fire stop.



FULL FILL

100mm cavity, full fill insulation ST90 1950-2400mm shown.



HEAVY DUTY

100mm cavity, full fill insulation Bespoke ST90HD shown for use where outer leaf has higher than average loading.



RENDERED FINISH

100mm cavity, full fill insulation, heavy duty application, mesh flange option for rendering, ST90HD 750-1800mm shown with wide outer leaf.

THERMALLY BROKEN LINTELS SUPATHERM

Can't find what
you're looking for?

Speak to our technical team
0330 404 9951

Sometimes a standard lintel just doesn't suit the architectural detailing of a building's design so a range of bespoke options are available on request.

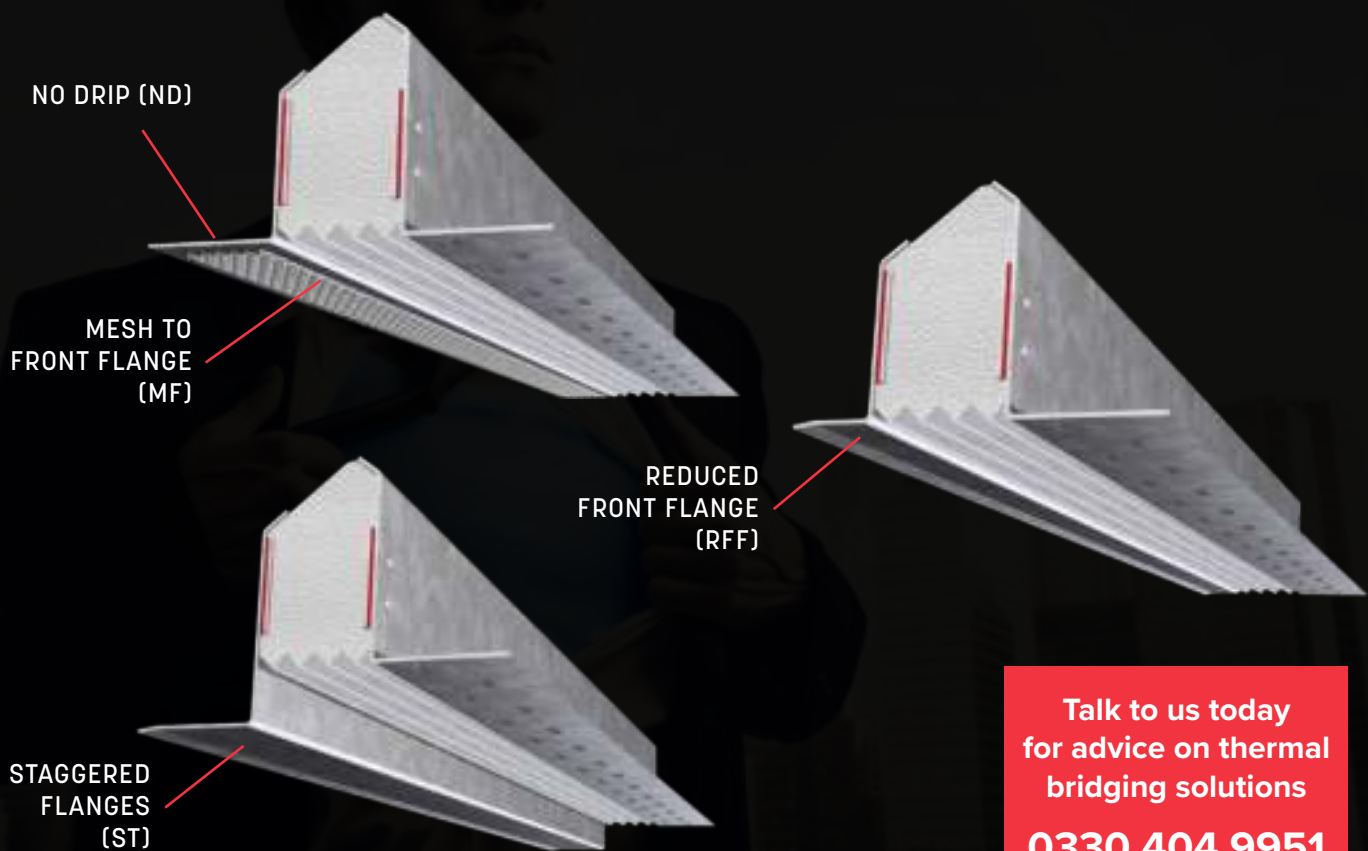

Talk to us today
for advice on thermal
bridging solutions
0330 404 9951

REFERENCE GUIDE:

MF

A mesh can be welded to the underside of the front flange as a key to allow a rendered soffit. As the lintel is galvanized after the mesh is attached, it doesn't compromise the integrity of the lintel.

To specify, add 'MF' to the end of the lintel reference e.g. ST90 MF.

ND

To minimise the mortar bed thickness at the end bearings, e.g. when using stone heads and surrounds, the weather drip on the front flange of the lintel can be omitted.

To specify, add 'ND' to the end of the lintel reference e.g. ST90 ND.

NM

Where the inner leaf of a cavity wall is fair-faced and the inner flange of the lintel is not plastered, the plaster key on this flange can be omitted.

To specify, add 'NM' to the end of the lintel reference e.g. ST90 NM.

RFF

The front flange of a lintel can be reduced in length. This is most useful when using a chamfered window head or narrow brick, when a standard flange would protrude. Also used in an eaves situation.

To specify, add 'RFF' to the end of the lintel reference, followed by the projection of the flange e.g. ST90 RFF50.









ST

Inner and outer leaf flanges can be staggered to allow for uneven coursing. Please contact our Technical Department for further information.

SUPATHERM LINTEL OPTIONS

**Need technical
advice?**

Speak to our technical team
0330 404 9951

	Load Ratio	ST Standard Duty		ST Heavy Duty			ST Extra Heavy Duty		
		1:3	Profile	1:3	1:19	Profile	1:5	1:19	Profile
Length (mm)	750	27		40	32		50	45	
	900	27		40	32		50	45	
	1050	27		40	32		50	45	
	1350	27		40	32		50	45	
	1500	25		40	32		55	45	
	1650	23		40	32		55	45	
	1800	21	148 high	40	32	148 high	55	50	223 high
	1950	31		40	32		58	50	
	2100	29		40	32		58	50	
	2250	27		40	32		58	50	
	2400	25	198 high	40	32		60	50	
	2550	23		40	32		60	50	
	2700	22		40	32		60	50	
	2850	21		40	32		60	50	
	3000	19		40	32		60	50	
	3300	16	203 high	34	27	231 high	60	50	223 high
	3600	13		28	22		54	45	
	3900	11		24	18		54	45	

BIRTLEY LINTELS:

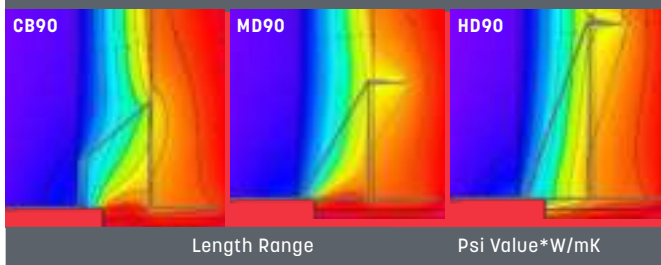

CB90	900	0.18
	1200-1350	0.178
	1500-1650	0.198
	1800-2100	0.2
	2250-2400	0.227
	2550	0.222
	2700-3000	0.217
	3300-3900	0.241
MD90	1800	0.226
HD90	1800	0.201

BIRTLEY SUPATHERM LINTELS:

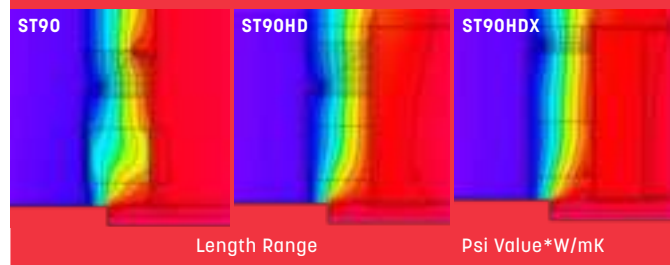

ST90	750-1050	0.098-0.057
	1200-1350	0.053-0.048
	1500-1650	0.043-0.039
	1800-2100	0.06-0.052
	2250-2400	0.048-0.043
	2550	0.039
	2700-3000	0.055-0.051
	3300-3900	0.037-0.031
ST90HD	1800	0.04
ST90HDX	1800	0.043

* Actual calculated values based on 100mm cavity, full fill insulation. Block $\lambda=0.45$.

* Actual calculated values based on 100mm cavity, full fill insulation. Block $\lambda=0.45$.

SUPATHERM LINTEL RANGE

Can't find what
you're looking for?

Speak to our technical team
0330 404 9951

SUPATHERM FOR HEROIC STRUCTURES

TYPICAL Ψ VALUE 0.03 - 0.06

SUPATHERM PROFILES:

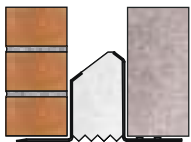

STANDARD DUTY
≤ 1800mm

ST90
ST110
ST130
ST150
Not suitable for point loads
or concrete floors

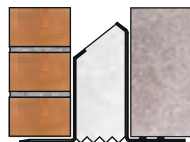

STANDARD DUTY
1950 - 2400mm

ST90
ST110
ST130
ST150
Not suitable for point loads
or concrete floors

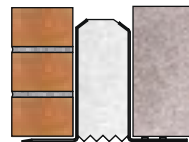

STANDARD DUTY
≥ 2550mm

ST90
ST110
ST130
ST150
Not suitable for point loads
or concrete floors

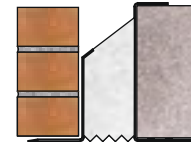

HEAVY DUTY
≤ 1800mm

ST90HD
ST110HD
ST130HD
ST150HD
Must have a solid fully jointed
blockwork infill to inner leaf

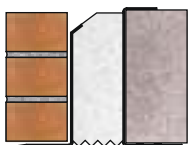

HEAVY DUTY
≤ 1950mm

ST90HD
ST110HD
ST130HD
ST150HD
Must have a solid fully jointed
blockwork infill to inner leaf

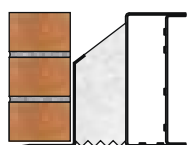

EXTRA HEAVY DUTY
≤ 1800mm

ST90HDX
ST110HDX
ST130HDX
ST150HDX

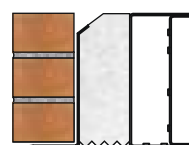

EXTRA HEAVY DUTY
≥ 2550mm

ST90HDX
ST110HDX
ST130HDX
ST150HDX

Talk to us today
for advice on thermal
bridging solutions
0330 404 9951

BIRTLEY LINTELS

50MM CAVITY WALLS

100MM INNER
100MM OUTER

50



STANDARD

Cavity **50-65mm**
Outer Leaf **100mm**
Inner Leaf **100mm**

Lintel Shown: CB50

CB50
STANDARD DUTY

Not suitable for point loads or concrete floors.

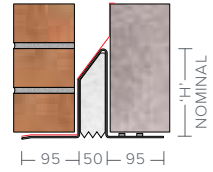

Length	750-1200	1200-1650	1650-1950	1950-2250	2250-2500	2500-2900	2900-3900
L (kN)	15	15	20	22	26	26	26
W (kg/m)	5.8	7.1	8.1	9.9	10.9	11.5	14
H (mm)	109	109	139	144	169	185	203

(L) Load SWL (W) Weight (H) Height

CB50HD
STANDARD/MEDIUM DUTY

Not suitable for point loads or concrete floors.

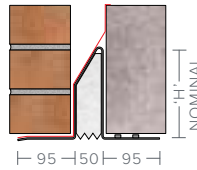

Length	750-1500	1650-2100	2550-3000
L (kN)	36	36	36
W (kg/m)	10.1	14	14.4
H (mm)	155	207	215

(L) Load SWL (W) Weight (H) Height

MD50
MEDIUM DUTY

Must have solid, fully jointed blockwork infill to inner leaf.

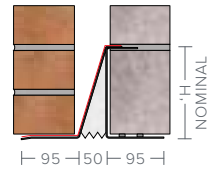

Length	750-1800	1950-2400	2550-3000	3150-3900
L (kN)	35	35	35	25
W (kg/m)	9.4	12.1	13.4	13.4
H (mm)	154	155	156	156

(L) Load SWL (W) Weight (H) Height

HD50
HEAVY DUTY

Must have solid, fully jointed blockwork infill to inner leaf.

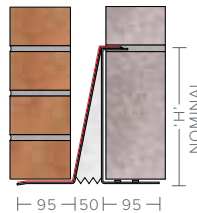

Length	750-1800	1950-2400	2550-2700	2850-3000	3150-3600	3750-4500	4650-4800	4950-5100
L (kN)	70	60	60	55	50	40	35	25
W (kg/m)	14.8	14.8	17.6	17.6	17.6	17.6	17.6	17.6
H (mm)	231	231	232	232	232	232	232	232

(L) Load SWL (W) Weight (H) Height

HDX50
EXTRA HEAVY DUTY

Must have solid, fully jointed blockwork infill to inner leaf.

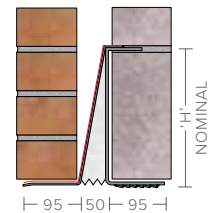

Length	750-2100	2250-3300	3450-4200	4350-4800	4950-5100
L (kN)	100	80	70	60	45
W (kg/m)	23.3	23.3	23.3	23.3	23.3
H (mm)	236	236	236	236	236

(L) Load SWL (W) Weight (H) Height

SX50
ULTRA HEAVY DUTY

203x133x30UB
Should be laterally restrained and propped during installation.

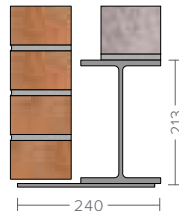

Length	750-4200	4350-4800	4950-5400	5550-5700	5850-6000	6150-6300	6450-6600
L (kN)	90	80	70	65	55	50	45
W (kg/m)	41.7	41.7	41.7	41.7	41.7	41.7	41.7
H (mm)	213	213	213	213	213	213	213

(L) Load SWL (W) Weight (H) Height

XHD50
EXTREME HEAVY DUTY

230x90x32PFC
Should be laterally restrained and propped during installation.

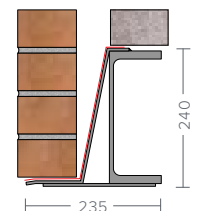

Length	750-4200	4350-4800	4950-5400	5550-6600
L (kN)	120	100	90	65
W (kg/m)	54.6	54.6	54.6	54.6
H (mm)	240	240	240	240

(L) Load SWL (W) Weight (H) Height

BIRTLEY LINTELS 50MM CAVITY WALLS

**WIDE INNER
100MM OUTER**



WIDE INNER

Cavity **50-65mm**
Outer Leaf **100mm**
Inner Leaf **125-140mm**

Lintel Shown: CB50/130

CAN'T FIND WHAT YOU'RE LOOKING FOR?

For further information or to ask us a specific question please contact our **technical team**

0330 404 9951

intel.technical@birtleygroup.co.uk

CB50/130 STANDARD DUTY

Not suitable for point loads or concrete floors.

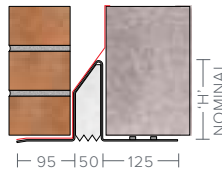

Length	750-1200	1200-1800	1800-2400	2400-2850	2850-3550	3550-3900
L (kN)	15	20	22	26	26	24
W (kg/m)	7.3	9.9	10.9	13.7	14.4	14.4
H (mm)	99	129	154	178	193	193

(L) Load SWL (W) Weight (H) Height

MD50/130 MEDIUM DUTY

Must have solid, fully jointed blockwork infill to inner leaf.

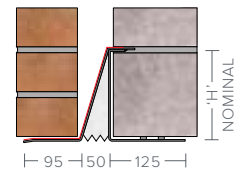

Length	750-3000	3150-3900
L (kN)	35	25
W (kg/m)	13.6	13.6
H (mm)	156	156

(L) Load SWL (W) Weight (H) Height

HD50/130 HEAVY DUTY

Must have solid, fully jointed blockwork infill to inner leaf.

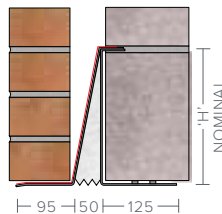

Length	750-1800	1950-2700	2850-3000	3150-3600	3750-4500	4650-4800	4950-5100
L (kN)	70	60	55	50	40	35	25
W (kg/m)	17.5	17.5	17.5	17.5	17.5	17.5	17.5
H (mm)	231	231	231	231	231	231	231

(L) Load SWL (W) Weight (H) Height

HDX50/130 EXTRA HEAVY DUTY

Must have solid, fully jointed blockwork infill to inner leaf.

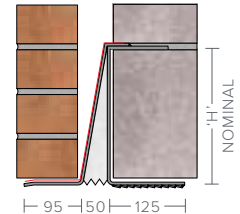

Length	750-2100	2250-3300	3450-4200	4350-4800	4950-5100
L (kN)	100	80	70	60	45
W (kg/m)	31.9	31.9	31.9	31.9	31.9
H (mm)	237	237	237	237	237

(L) Load SWL (W) Weight (H) Height

SX50/130 ULTRA HEAVY DUTY

203x133x30UB
Should be laterally restrained and propped during installation.

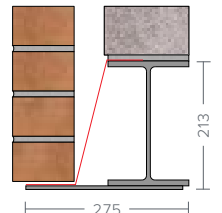

Length	750-4200	4350-4800	4950-5400	5550-5700	5850-6000	6150-6300	6450-6600
L (kN)	90	80	70	65	55	50	45
W (kg/m)	43.1	43.1	43.1	43.1	43.1	43.1	43.1
H (mm)	213	213	213	213	213	213	213

(L) Load SWL (W) Weight (H) Height

XHD50/130 EXTREME HEAVY DUTY

230x90x32PFC
Should be laterally restrained and propped during installation.

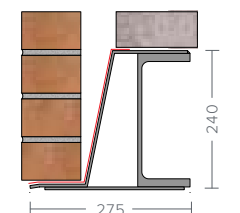

Length	750-4200	4350-4800	4950-5400	5550-6600
L (kN)	120	100	90	65
W (kg/m)	59.2	59.2	59.2	59.2
H (mm)	240	240	240	240

(L) Load SWL (W) Weight (H) Height

BIRTLEY LINTELS 50MM CAVITY WALLS

**100MM INNER
WIDE OUTER**

50



WIDE OUTER

Cavity **50-65mm**
Outer Leaf **125-140mm**
Inner Leaf **100mm**

Lintel Shown: *CB125/50/100*

CAN'T FIND WHAT YOU'RE LOOKING FOR?

For further information or to ask us a specific question please contact our **technical team**

0330 404 9951

intel.technical@birtleygroup.co.uk

CB125/50/100 STANDARD DUTY

Not suitable for point loads or concrete floors.

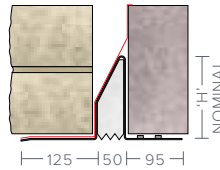

Length	750-1500	1500-2400	2400-3350	3350-3900
L (kN)	25	30	30	26
W (kg/m)	8.5	11.8	14.8	14.8
H (mm)	134	178	198	198

(L) Load SWL (W) Weight (H) Height

MD125/50/100 MEDIUM DUTY

Must have solid, fully jointed blockwork infill to inner leaf.

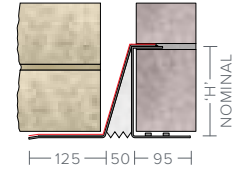

Length	750-3000	3150-3900
L (kN)	35	25
W (kg/m)	14.3	14.3
H (mm)	155	155

(L) Load SWL (W) Weight (H) Height

HD125/50/100 HEAVY DUTY

Must have solid, fully jointed blockwork infill to inner leaf.

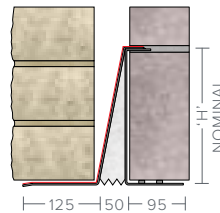

Length	750-1800	1950-2700	2850-3000	3150-3600	3750-4500	4650-4800	4950-5100
L (kN)	70	60	55	50	40	35	25
W (kg/m)	17.2	17.2	17.2	17.2	17.2	17.2	17.2
H (mm)	231	231	231	231	231	231	231

(L) Load SWL (W) Weight (H) Height

HDX125/50/100 EXTRA HEAVY DUTY

Must have solid, fully jointed blockwork infill to inner leaf.

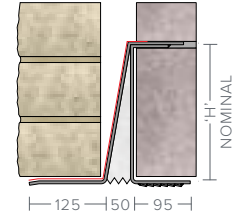

Length	750-2100	2250-3300	3450-4200	4350-4800	4950-5100
L (kN)	100	80	70	60	45
W (kg/m)	31.9	31.9	31.9	31.9	31.9
H (mm)	237	237	237	237	237

(L) Load SWL (W) Weight (H) Height

SX125/50/100 ULTRA HEAVY DUTY

203x133x30UB
Should be laterally restrained and propped during installation.

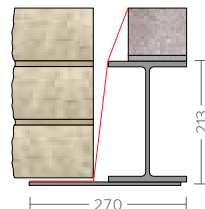

Length	750-4200	4350-4800	4950-5400	5550-5700	5850-6000	6150-6300	6450-6600
L (kN)	90	80	70	65	55	50	45
W (kg/m)	43.1	43.1	43.1	43.1	43.1	43.1	43.1
H (mm)	213	213	213	213	213	213	213

(L) Load SWL (W) Weight (H) Height

XHD125/50/100 EXTREME HEAVY DUTY

230x90x32PFC
Should be laterally restrained and propped during installation.

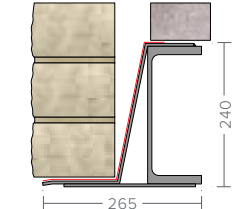

Length	750-4200	4350-4800	4950-5400	5550-6600
L (kN)	120	100	90	65
W (kg/m)	57.7	57.7	57.7	57.7
H (mm)	240	240	240	240

(L) Load SWL (W) Weight (H) Height

BIRTLEY LINTELS 70MM CAVITY WALLS

**100MM INNER
100MM OUTER**



STANDARD

Cavity **70-85mm**
Outer Leaf **100mm**
Inner Leaf **100mm**

Lintel Shown: MD70

CB70

STANDARD DUTY

Not suitable for point loads or concrete floors.

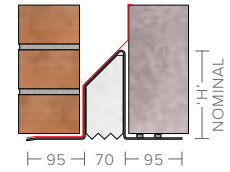

Length	750-1200	1350-1500	1650-2100	2250-2400	2550-3000	3150-3900
L (kN)	15	15	20	22	26	26
W (kg/m)	5.8	7.1	8.3	10.1	11.5	14
H (mm)	108	108	143	148	185	201

(L) Load SWL (W) Weight (H) Height

CB70HD

STANDARD/MEDIUM DUTY

Not suitable for point loads or concrete floors.

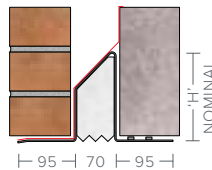

Length	750-1500	1650-2100	2250-3000
L (kN)	36	36	36
W (kg/m)	10.1	14	14.4
H (mm)	149	201	208

(L) Load SWL (W) Weight (H) Height

MD70

MEDIUM DUTY

Must have solid, fully jointed blockwork infill to inner leaf.

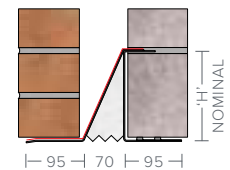

Length	750-1800	1950-2400	2550-3000	3150-3900
L (kN)	35	35	35	25
W (kg/m)	9.7	12.5	13.4	13.4
H (mm)	154	155	156	156

(L) Load SWL (W) Weight (H) Height

HD70

HEAVY DUTY

Must have solid, fully jointed blockwork infill to inner leaf.

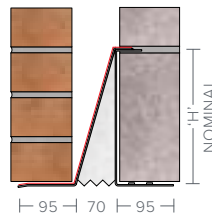

Length	750-1800	1950-2400	2550-2700	2850-3000	3150-3300	3450-3900	4050-4200	4350-4800	4950-5100
L (kN)	70	60	60	55	50	45	40	35	25
W (kg/m)	14.8	14.8	17.6	17.6	17.6	17.6	17.6	17.6	17.6
H (mm)	231	231	232	232	232	231	232	232	232

(L) Load SWL (W) Weight (H) Height

HDX70

EXTRA HEAVY DUTY

Must have solid, fully jointed blockwork infill to inner leaf.

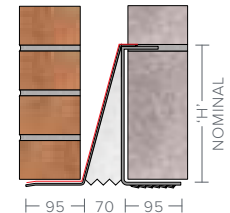

Length	750-2100	2250-3300	3450-4200	4350-4800	4950-5100
L (kN)	100	80	70	60	45
W (kg/m)	23.3	23.3	23.3	23.3	23.3
H (mm)	236	236	236	236	236

(L) Load SWL (W) Weight (H) Height

SX70

ULTRA HEAVY DUTY

203x133x30UB

Should be laterally restrained and propped during installation.

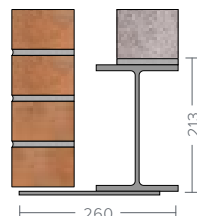

Length	750-4200	4350-4800	4950-5400	5550-5700	5850-6000	6150-6300	6450-6600
L (kN)	90	80	70	65	55	50	45
W (kg/m)	41.7	41.7	41.7	41.7	41.7	41.7	41.7
H (mm)	231	213	213	213	213	213	213

(L) Load SWL (W) Weight (H) Height

XHD70

EXTREME HEAVY DUTY

230x90x32PFC

Should be laterally restrained and propped during installation.

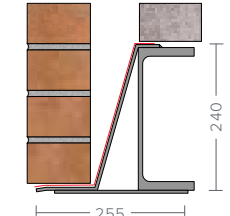

Length	750-4200	4350-4800	4950-5400	5550-6600
L (kN)	120	100	90	65
W (kg/m)	55.4	55.4	55.4	55.4
H (mm)	240	240	240	240

(L) Load SWL (W) Weight (H) Height

BIRTLEY LINTELS 70MM CAVITY WALLS

**WIDE INNER
100MM OUTER**

70



WIDE INNER

Cavity **70-85mm**
Outer Leaf **100mm**
Inner Leaf **125-140mm**

Lintel Shown: MD70/130

CAN'T FIND WHAT YOU'RE LOOKING FOR?

For further information or to ask us a specific question please contact our **technical team**

0330 404 9951

lintel.technical@birtleygroup.co.uk

CB70/130 STANDARD DUTY

Not suitable for point loads or concrete floors.

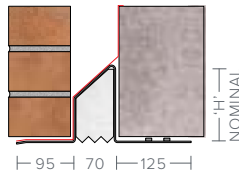

Length	750-1200	1350-1800	1950-2400	2550-2850	3000-3900
L (kN)	15	22	22	30	26
W (kg/m)	7.3	9.9	10.9	13.7	14.4
H (mm)	98	127	152	177	192

(L) Load SWL (W) Weight (H) Height

MD70/130 MEDIUM DUTY

Must have solid, fully jointed blockwork infill to inner leaf.

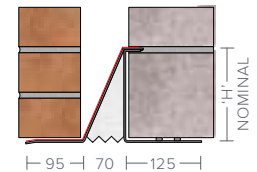

Length	750-3000	3150-3900
L (kN)	35	25
W (kg/m)	13.6	13.6
H (mm)	156	156

(L) Load SWL (W) Weight (H) Height

HD70/130 HEAVY DUTY

Must have solid, fully jointed blockwork infill to inner leaf.

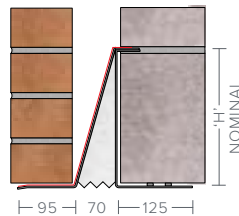

Length	750-1800	1950-2700	2850-3000	3150-3300	3450-3900	4050-4200	4350-4800	4950-5100
L (kN)	70	60	55	50	45	40	35	25
W (kg/m)	17.5	17.5	17.5	17.5	17.5	17.5	17.5	17.5
H (mm)	231	231	231	231	231	231	231	231

(L) Load SWL (W) Weight (H) Height

HDX70/130 EXTRA HEAVY DUTY

Must have solid, fully jointed blockwork infill to inner leaf.

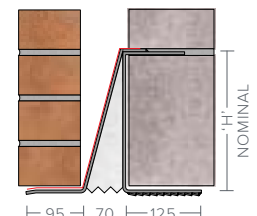

Length	750-2100	2250-3300	3450-4200	4350-4800	4950-5100
L (kN)	100	80	70	60	45
W (kg/m)	31.9	31.9	31.9	31.9	31.9
H (mm)	237	237	237	237	237

(L) Load SWL (W) Weight (H) Height

SX70/130 ULTRA HEAVY DUTY

203x133x30UB
Should be laterally restrained and propped during installation.

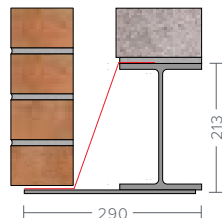

Length	750-4200	4350-4800	4950-5400	5550-5700	5850-6000	6150-6300	6450-6600
L (kN)	90	80	70	65	55	50	45
W (kg/m)	43.1	43.1	43.1	43.1	43.1	43.1	43.1
H (mm)	213	213	213	213	213	213	213

(L) Load SWL (W) Weight (H) Height

XHD70/130 EXTREME HEAVY DUTY

230x90x32PFC
Should be laterally restrained and propped during installation.

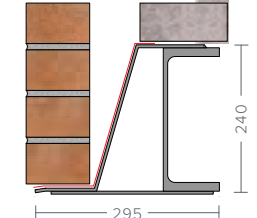

Length	750-4200	4350-4800	4950-5400	5550-6600
L (kN)	120	100	90	65
W (kg/m)	60	60	60	60
H (mm)	240	240	240	240

(L) Load SWL (W) Weight (H) Height

BIRTLEY LINTELS 70MM CAVITY WALLS

**100MM INNER
WIDE OUTER**



CAN'T FIND WHAT YOU'RE LOOKING FOR?

For further information or to ask us a specific question please contact our **technical team**

0330 404 9951

intel.technical@birtleygroup.co.uk

70

CB125/70/100 STANDARD DUTY

Not suitable for point loads or concrete floors.

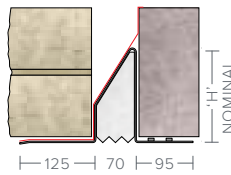

Length	750-1500	1650-2400	2550-3000	3150-3900
L (kN)	25	30	30	25
W (kg/m)	10.9	11.8	14.6	14.6
H (mm)	157	181	202	202

(L) Load SWL (W) Weight (H) Height

MD125/70/100 MEDIUM DUTY

Must have solid, fully jointed blockwork infill to inner leaf.

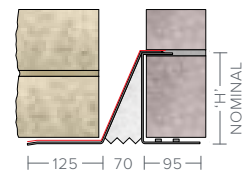

Length	750-3000	3150-3900
L (kN)	35	25
W (kg/m)	14.3	14.3
H (mm)	155	155

(L) Load SWL (W) Weight (H) Height

HD125/70/100 HEAVY DUTY

Must have solid, fully jointed blockwork infill to inner leaf.

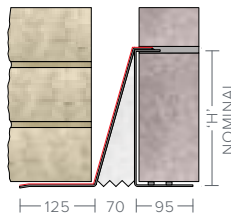

Length	750-1800	1950-2700	2850-3000	3150-3300	3450-3900	4050-4200	4350-4800	4950-5100
L (kN)	70	60	55	50	45	40	35	25
W (kg/m)	17.2	17.2	17.2	17.2	17.2	17.2	17.2	17.2
H (mm)	231	231	231	231	231	231	231	231

(L) Load SWL (W) Weight (H) Height

HDX125/70/100 EXTRA HEAVY DUTY

Must have solid, fully jointed blockwork infill to inner leaf.

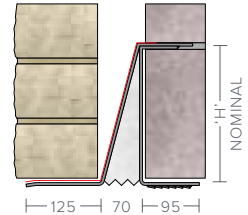

Length	750-2100	2250-3300	3450-4200	4350-4800	4950-5100
L (kN)	100	80	70	60	45
W (kg/m)	31.9	31.9	31.9	31.9	31.9
H (mm)	237	237	237	237	237

(L) Load SWL (W) Weight (H) Height

SX125/70/100 ULTRA HEAVY DUTY

203x133x30UB
Should be laterally restrained and propped during installation.

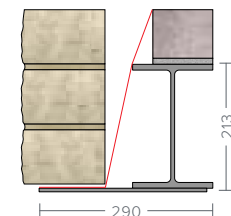

Length	750-4200	4350-4800	4950-5400	5550-5700	5850-6000	6150-6300	6450-6600
L (kN)	90	80	70	65	55	50	45
W (kg/m)	43.1	43.1	43.1	43.1	43.1	43.1	43.1
H (mm)	213	213	213	213	213	213	213

(L) Load SWL (W) Weight (H) Height

XHD125/70/100 EXTREME HEAVY DUTY

230X90X32PFC
Should be laterally restrained and propped during installation.

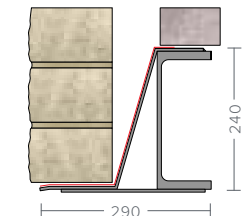

Length	750-4200	4350-4800	4950-5400	5550-6600
L (kN)	120	100	90	65
W (kg/m)	59.2	59.2	59.2	59.2
H (mm)	240	240	240	240

(L) Load SWL (W) Weight (H) Height

BIRTLEY LINTELS 90MM CAVITY WALLS

**100MM INNER
100MM OUTER**



STANDARD

Cavity **90-105mm**
Outer Leaf **100mm**
Inner Leaf **100mm**

Lintel Shown: HD90

CB90
STANDARD DUTY

Not suitable for point loads or concrete floors.



Length	750-1050	1200-1350	1500-1650	1800-2100	2250-2400	2550	2700-3000	3150-3900
L (kN)	15	15	15	20	22	26	26	26
W (kg/m)	5.8	5.9	7.3	8.3	10.1	10.9	11.8	14.4
H (mm)	97	102	102	132	141	157	181	197

(L) Load SWL (W) Weight (H) Height

CB90HD
STANDARD/MEDIUM DUTY

Not suitable for point loads or concrete floors.

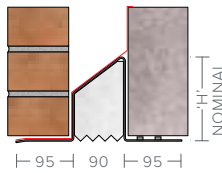

Length	750-1500	1650-2100	2250-3000
L (kN)	36	36	36
W (kg/m)	10.1	14	14.4
H (mm)	141	193	201

(L) Load SWL (W) Weight (H) Height

MD90
MEDIUM DUTY

Must have solid, fully jointed blockwork infill to inner leaf.

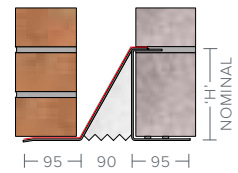

Length	750-1800	1950-2400	2550-3000	3150-3900
L (kN)	35	35	35	25
W (kg/m)	9.7	12.6	13.5	13.5
H (mm)	154	155	156	156

(L) Load SWL (W) Weight (H) Height

HD90
HEAVY DUTY

Must have solid, fully jointed blockwork infill to inner leaf.

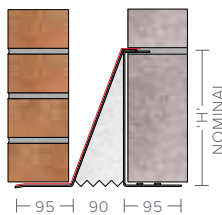

Length	750-1800	1950-2400	2550-2700	2850-3000	3150-3600	3750-4200	4350-4800	4950-5100
L (kN)	70	60	60	55	45	40	35	25
W (kg/m)	14.8	14.8	17.6	17.6	17.6	17.6	17.6	17.6
H (mm)	231	231	232	232	232	232	232	232

(L) Load SWL (W) Weight (H) Height

HDX90
EXTRA HEAVY DUTY

Must have solid, fully jointed blockwork infill to inner leaf.

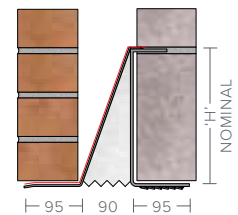

Length	750-2100	2250-3300	3450-4200	4350-4800	4950-5100
L (kN)	100	80	70	60	45
W (kg/m)	23.3	23.3	23.3	23.3	23.3
H (mm)	236	236	236	236	236

(L) Load SWL (W) Weight (H) Height

SX90
ULTRA HEAVY DUTY

203x133x30UB

Should be laterally restrained and propped during installation.

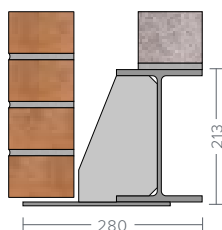

Length	750-4200	4350-4800	4950-5400	5550-5700	5850-6000	6150-6300	6450-6600
L (kN)	90	80	70	65	55	50	45
W (kg/m)	41.7	41.7	41.7	41.7	41.7	41.7	41.7
H (mm)	213	213	213	213	213	213	213

(L) Load SWL (W) Weight (H) Height

XHD90
EXTREME HEAVY DUTY

230x90x32PFC

Should be laterally restrained and propped during installation.

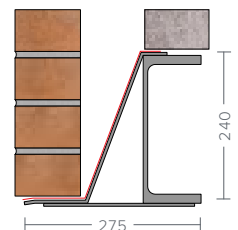

Length	750-4200	4350-4800	4950-5400	5550-6600
L (kN)	120	100	90	65
W (kg/m)	56.1	56.1	56.1	56.1
H (mm)	240	240	240	240

(L) Load SWL (W) Weight (H) Height

BIRTLEY LINTELS 90MM CAVITY WALLS

**WIDE INNER
100MM OUTER**



WIDE INNER

Cavity **90-105mm**
Outer Leaf **100mm**
Inner Leaf **125-140mm**

Lintel Shown: HD90/130

CAN'T FIND WHAT YOU'RE LOOKING FOR?

For further information or to ask us a specific question please contact our **technical team**

0330 404 9951

intel.technical@birtleygroup.co.uk

CB90/130 STANDARD DUTY

Not suitable for point loads or concrete floors.

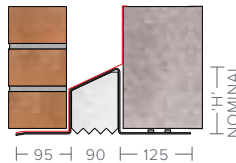

Length	750-1200	1350-1800	1950-2400	2550-2850	3000-3900
L (kN)	15	22	22	30	26
W (kg/m)	7.3	9.9	10.9	13.7	14.4
H (mm)	86	116	141	166	181

(L) Load SWL (W) Weight (H) Height

MD90/130 MEDIUM DUTY

Must have solid, fully jointed blockwork infill to inner leaf.

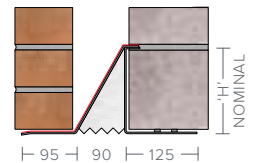

Length	750-3000	3150-3900
L (kN)	35	25
W (kg/m)	13.6	13.6
H (mm)	156	156

(L) Load SWL (W) Weight (H) Height

HD90/130 HEAVY DUTY

Must have solid, fully jointed blockwork infill to inner leaf.

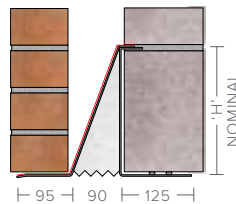

Length	750-1800	1950-2700	2850-3000	3150-3600	3750-4200	4350-4800	4950-5100
L (kN)	70	60	55	45	40	35	25
W (kg/m)	17.5	17.5	17.5	17.5	17.5	17.5	17.5
H (mm)	231	231	231	231	231	231	231

(L) Load SWL (W) Weight (H) Height

HDX90/130 EXTRA HEAVY DUTY

Must have solid, fully jointed blockwork infill to inner leaf.

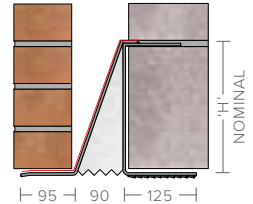

Length	750-2100	2250-3300	3450-4200	4350-4800	4950-5100
L (kN)	100	80	70	60	45
W (kg/m)	31.9	31.9	31.9	31.9	31.9
H (mm)	237	237	237	237	237

(L) Load SWL (W) Weight (H) Height

SX90/130 ULTRA HEAVY DUTY

203x133x30UB
Should be laterally restrained and propped during installation.

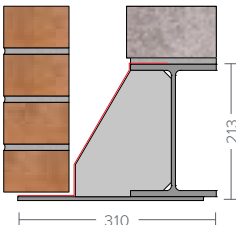

Length	750-4200	4350-4800	4950-5400	5550-5700	5850-6000	6150-6300	6450-6600
L (kN)	90	80	70	65	55	50	45
W (kg/m)	43.1	43.1	43.1	43.1	43.1	43.1	43.1
H (mm)	213	213	213	213	213	213	213

(L) Load SWL (W) Weight (H) Height

XHD90/130 EXTREME HEAVY DUTY

Should be laterally restrained and propped during installation.

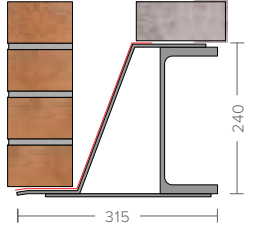

Length	750-4200	4350-4800	4950-5400	5550-6600
L (kN)	120	100	90	65
W (kg/m)	60	60	60	60
H (mm)	240	240	240	240

(L) Load SWL (W) Weight (H) Height

BIRTLEY LINTELS 90MM CAVITY WALLS

**100MM INNER
WIDE OUTER**



WIDE OUTER

Cavity **90-105mm**
Outer Leaf **125-140mm**
Inner Leaf **100mm**

Lintel Shown: HD125/90/100

CAN'T FIND WHAT YOU'RE LOOKING FOR?

For further information or to ask us a specific question please contact our **technical team**

0330 404 9951

lintel.technical@birtleygroup.co.uk

CB125/90/100 STANDARD DUTY

Not suitable for point loads or concrete floors.

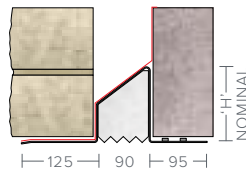

Length	750-1500	1650-2400	2550-3000	3150-3900
L (kN)	25	30	30	25
W (kg/m)	8.5	11.8	14.6	14.6
H (mm)	126	170	191	191

(L) Load SWL (W) Weight (H) Height

MD125/90/100 MEDIUM DUTY

Must have solid, fully jointed blockwork infill to inner leaf.

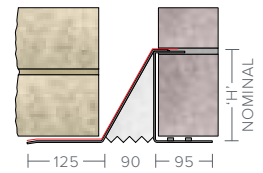

Length	750-3000	3150-3900
L (kN)	35	25
W (kg/m)	14.3	14.3
H (mm)	155	155

(L) Load SWL (W) Weight (H) Height

HD125/90/100 HEAVY DUTY

Must have solid, fully jointed blockwork infill to inner leaf.

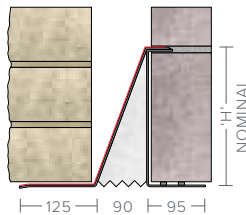

Length	750-1800	1950-2700	2850-3000	3150-3600	3750-4200	4350-4800	4950-5100
L (kN)	70	60	55	45	40	35	25
W (kg/m)	17.7	17.7	17.7	17.7	17.7	17.7	17.7
H (mm)	231	231	231	231	231	231	231

(L) Load SWL (W) Weight (H) Height

HDX125/90/100 EXTRA HEAVY DUTY

Must have solid, fully jointed blockwork infill to inner leaf.

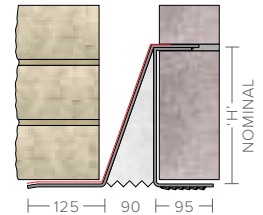

Length	750-2100	2250-3300	3450-4200	4350-4800	4950-5100
L (kN)	100	80	70	60	45
W (kg/m)	31.9	31.9	31.9	31.9	31.9
H (mm)	237	237	237	237	237

(L) Load SWL (W) Weight (H) Height

SX125/90/100 ULTRA HEAVY DUTY

203x133x30UB
Should be laterally restrained and propped during installation.

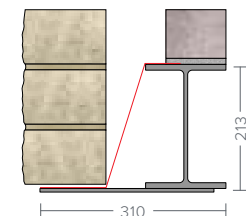

Length	750-4200	4350-4800	4950-5400	5550-5700	5850-6000	6150-6300	6450-6600
L (kN)	90	80	70	65	55	50	45
W (kg/m)	43.1	43.1	43.1	43.1	43.1	43.1	43.1
H (mm)	213	213	213	213	213	213	213

(L) Load SWL (W) Weight (H) Height

XHD125/90/100 EXTREME HEAVY DUTY

230x90x32PFC
Should be laterally restrained and propped during installation.

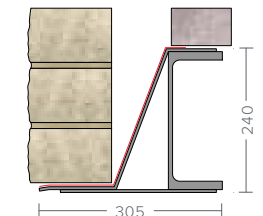

Length	750-4200	4350-4800	4950-5400	5550-6600
L (kN)	120	100	90	65
W (kg/m)	60	60	60	60
H (mm)	240	240	240	240

(L) Load SWL (W) Weight (H) Height

BIRTLEY LINTELS 110MM CAVITY WALLS

**100MM INNER
100MM OUTER**



STANDARD

Cavity **110-125mm**
Outer Leaf **100mm**
Inner Leaf **100mm**

Lintel Shown: HDX110

**CAN'T FIND WHAT YOU'RE
LOOKING FOR?**

For further information or to ask us a specific question please contact our **technical team**

0330 404 9951

intel.technical@birtleygroup.co.uk

CB110
STANDARD DUTY

Not suitable for point loads or concrete floors.

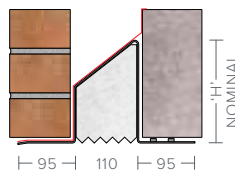

Length	750-1500	1650-2100	2250-2700	2850-3300
L (kN)	20	20	25	30
W (kg/m)	8.3	10	11.5	14.4
H (mm)	132	134	173	196

(L) Load SWL (W) Weight (H) Height

MD110
MEDIUM DUTY

Must have solid, fully jointed blockwork infill to inner leaf.

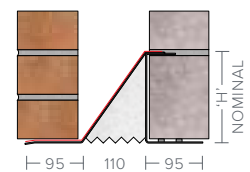

Length	750-1800	1950-2400	2550-3000	3150-3900
L (kN)	35	35	35	25
W (kg/m)	10.1	12.9	13.9	13.9
H (mm)	154	155	156	156

(L) Load SWL (W) Weight (H) Height

HD110
HEAVY DUTY

Must have solid, fully jointed blockwork infill to inner leaf.

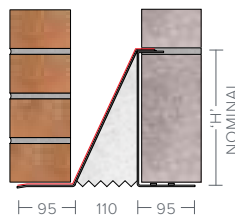

Length	750-1800	1950-2400	2550-2700	2850-3000	3150-3600	3750-3900	4050-4500	4650-4800	4950-5100
L (kN)	70	60	60	55	50	45	40	35	25
W (kg/m)	15.1	15.1	18	18	18	18	18	18	18
H (mm)	231	231	232	232	232	232	232	232	232

(L) Load SWL (W) Weight (H) Height

HDX110
EXTRA HEAVY DUTY

Must have solid, fully jointed blockwork infill to inner leaf.

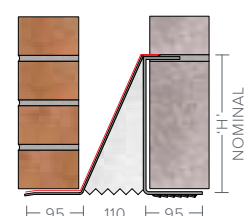

Length	750-2100	2250-3300	3450-4200	4350-4800	4950-5100
L (kN)	100	80	70	60	45
W (kg/m)	23.7	23.7	23.7	23.7	23.7
H (mm)	236	236	236	236	236

(L) Load SWL (W) Weight (H) Height

SX110
ULTRA HEAVY DUTY

203x133x30UB
Should be laterally restrained and propped during installation.

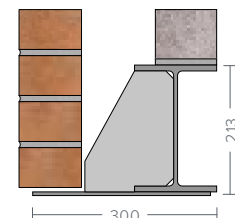

Length	750-4200	4350-4800	4950-5400	5550-5700	5850-6000	6150-6300	6450-6600
L (kN)	90	80	70	65	55	50	45
W (kg/m)	44.6	44.6	44.6	44.6	44.6	44.6	44.6
H (mm)	213	213	213	213	213	213	213

(L) Load SWL (W) Weight (H) Height

XHD110
EXTREME HEAVY DUTY

230x90x32PFC
Should be laterally restrained and propped during installation.

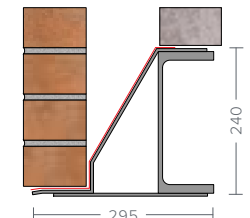

Length	750-4200	4350-4800	4950-5400	5550-6600
L (kN)	120	100	90	65
W (kg/m)	59.6	59.6	59.6	59.6
H (mm)	240	240	240	240

(L) Load SWL (W) Weight (H) Height

BIRTLEY LINTELS 110MM CAVITY WALLS

**WIDE INNER
100MM OUTER**



WIDE INNER

Cavity **110-125mm**
Outer Leaf **100mm**
Inner Leaf **125-140mm**

Lintel Shown: HDX110/130

**CAN'T FIND WHAT YOU'RE
LOOKING FOR?**

For further information or to ask us a specific question please contact our **technical team**

0330 404 9951

intel.technical@birtleygroup.co.uk

110

CB110/130
STANDARD DUTY

Not suitable for point loads or concrete floors.

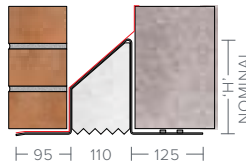

Length	750-2100	2250-2550	2700-3000	3150-3900
L (kN)	30	25	30	23
W (kg/m)	11.5	11.8	14.4	14.4
H (mm)	160	167	183	183

(L) Load SWL (W) Weight (H) Height

MD110/130
MEDIUM DUTY

Must have solid, fully jointed blockwork infill to inner leaf.

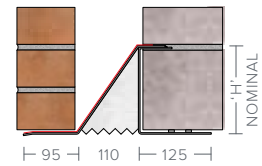

Length	750-3000	3150-3900
L (kN)	35	25
W (kg/m)	15.1	15.1
H (mm)	156	156

(L) Load SWL (W) Weight (H) Height

HD110/130
HEAVY DUTY

Must have solid, fully jointed blockwork infill to inner leaf.

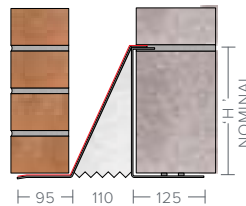

Length	750-1800	1950-2700	2850-3000	3150-3600	3750-3900	4050-4500	4650-4800	4950-5100
L (kN)	70	60	55	50	45	40	35	25
W (kg/m)	17.5	17.5	17.5	17.5	17.5	17.5	17.5	17.5
H (mm)	231	231	231	231	231	231	231	231

(L) Load SWL (W) Weight (H) Height

HDX110/130
EXTRA HEAVY DUTY

Must have solid, fully jointed blockwork infill to inner leaf.

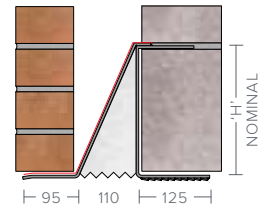

Length	750-2100	2250-3300	3450-4200	4350-4800	4950-5100
L (kN)	100	80	70	60	45
W (kg/m)	31.9	31.9	31.9	31.9	31.9
H (mm)	237	237	237	237	237

(L) Load SWL (W) Weight (H) Height

SX110/130
ULTRA HEAVY DUTY

203x133x30UB
Should be laterally restrained and propped during installation.

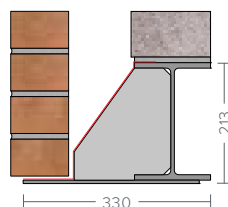

Length	750-4200	4350-4800	4950-5400	5550-5700	5850-6000	6150-6300	6450-6600
L (kN)	90	80	70	65	55	50	45
W (kg/m)	46	46	46	46	46	46	46
H (mm)	213	213	213	213	213	213	213

(L) Load SWL (W) Weight (H) Height

XHD110/130
EXTREME HEAVY DUTY

230x90x32PFC
Should be laterally restrained and propped during installation.

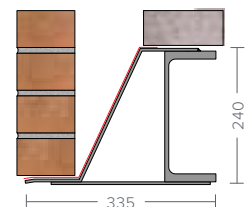

Length	750-4200	4350-4800	4950-5400	5550-6600
L (kN)	120	100	90	65
W (kg/m)	60.7	60.7	60.7	60.7
H (mm)	240	240	240	240

(L) Load SWL (W) Weight (H) Height

BIRTLEY LINTELS 110MM CAVITY WALLS

**100MM INNER
WIDE OUTER**



WIDE OUTER

Cavity **110-125mm**
Outer Leaf **125-140mm**
Inner Leaf **100mm**

Lintel Shown: HDX125/110/100

CAN'T FIND WHAT YOU'RE LOOKING FOR?

For further information or to ask us a specific question please contact our **technical team**

0330 404 9951

intel.technical@birtleygroup.co.uk

CB125/110/100 STANDARD DUTY

Not suitable for point loads or concrete floors.

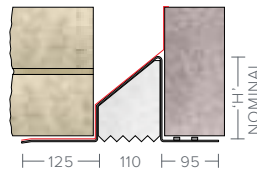

Length	750-1650	1800-2400	2550-3000	3150-3900
L (kN)	30	21	32	24
W (kg/m)	9.9	9.9	14.6	14.6
H (mm)	142	142	187	187

(L) Load SWL (W) Weight (H) Height

MD125/110/100 MEDIUM DUTY

Must have solid, fully jointed blockwork infill to inner leaf.

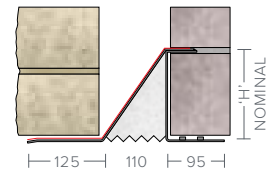

Length	750-3000	3150-3900
L (kN)	35	25
W (kg/m)	15	15
H (mm)	155	155

(L) Load SWL (W) Weight (H) Height

HD125/110/100 HEAVY DUTY

Must have solid, fully jointed blockwork infill to inner leaf.

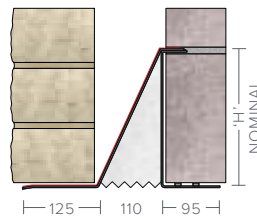

Length	750-1800	1950-2700	2850-3000	3150-3600	3750-3900	4050-4500	4650-4800	4950-5100
L (kN)	70	60	55	50	45	40	35	25
W (kg/m)	17.7	17.7	17.7	17.7	17.7	17.7	17.7	17.7
H (mm)	231	231	231	231	231	231	231	231

(L) Load SWL (W) Weight (H) Height

HDX125/110/100 EXTRA HEAVY DUTY

Must have solid, fully jointed blockwork infill to inner leaf.

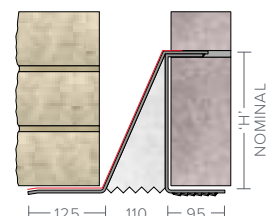

Length	750-2100	2250-3300	3450-4200	4350-4800	4950-5100
L (kN)	100	80	70	60	45
W (kg/m)	31.9	31.9	31.9	31.9	31.9
H (mm)	237	237	237	237	237

(L) Load SWL (W) Weight (H) Height

SX125/110/100 ULTRA HEAVY DUTY

203x133x30UB
Should be laterally restrained and propped during installation.

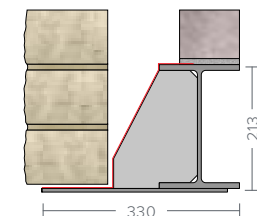

Length	750-4200	4350-4800	4950-5400	5550-5700	5850-6000	6150-6300	6450-6600
L (kN)	90	80	70	65	55	50	45
W (kg/m)	46	46	46	46	46	46	46
H (mm)	213	213	213	213	213	213	213

(L) Load SWL (W) Weight (H) Height

XHD125/110/100 EXTREME HEAVY DUTY

230x90x32PFC
Should be laterally restrained and propped during installation.

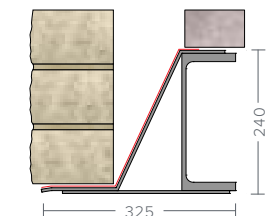

Length	750-4200	4350-4800	4950-5400	5550-6600
L (kN)	120	100	90	65
W (kg/m)	60	60	60	60
H (mm)	240	240	240	240

(L) Load SWL (W) Weight (H) Height

BIRTLEY LINTELS 130MM CAVITY WALLS

**100MM INNER
100MM OUTER**



STANDARD

Cavity **130-145mm**
Outer Leaf **100mm**
Inner Leaf **100mm**

Lintel Shown: SX130

**CAN'T FIND WHAT YOU'RE
LOOKING FOR?**

For further information or to ask us a specific question please contact our **technical team**

0330 404 9951

intel.technical@birtleygroup.co.uk

CB130
STANDARD DUTY

Not suitable for point loads or concrete floors.

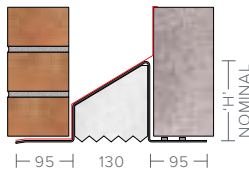

Length	750-1500	1650-1950	2100	2250-2700	2850-3300
L (kN)	20	20	20	25	30
W (kg/m)	8.3	10	10.4	11.8	14.4
H (mm)	122	124	134	164	187

(L) Load SWL (W) Weight (H) Height

MD130
MEDIUM DUTY

Must have solid, fully jointed blockwork infill to inner leaf.

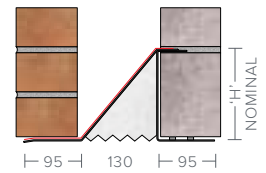

Length	750-1800	1950-3000	3150-3900
L (kN)	35	35	25
W (kg/m)	10.3	14.3	14.3
H (mm)	154	156	156

(L) Load SWL (W) Weight (H) Height

HD130
HEAVY DUTY

Must have solid, fully jointed blockwork infill to inner leaf.

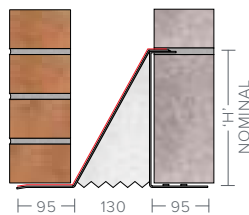

Length	750-1800	1950-2400	2550-2700	2850-3000	3150-3600	3750-3900	4050-4500	4650-4800	4950-5100
L (kN)	70	60	60	55	50	45	40	35	25
W (kg/m)	15.4	15.4	18.3	18.3	18.3	18.3	18.3	18.3	18.3
H (mm)	231	231	232	232	232	232	232	232	232

(L) Load SWL (W) Weight (H) Height

HDX130
EXTRA HEAVY DUTY

Must have solid, fully jointed blockwork infill to inner leaf.

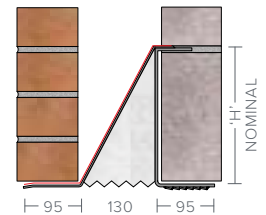

Length	750-2100	2250-3300	3450-4200	4350-4800	4950-5100
L (kN)	100	80	70	60	45
W (kg/m)	24	24	24	24	24
H (mm)	236	236	236	236	236

(L) Load SWL (W) Weight (H) Height

SX130
ULTRA HEAVY DUTY

203x133x30UB

Should be laterally restrained and propped during installation.

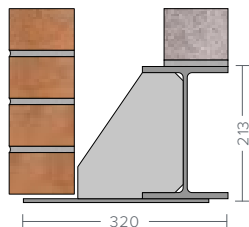

Length	750-4200	4350-4800	4950-5400	5550-5700	5850-6000	6150-6300	6450-6600
L (kN)	90	80	70	65	55	50	45
W (kg/m)	44.6	44.6	44.6	44.6	44.6	44.6	44.6
H (mm)	213	213	213	213	213	213	213

(L) Load SWL (W) Weight (H) Height

XHD130
EXTREME HEAVY DUTY

230x90x32PFC

Should be laterally restrained and propped during installation.

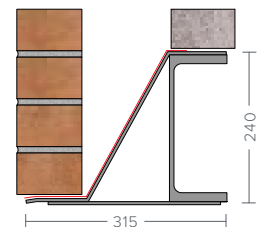

Length	750-4200	4350-4800	4950-5400	5550-6600
L (kN)	120	100	90	65
W (kg/m)	60.4	60.4	60.4	60.4
H (mm)	240	240	240	240

(L) Load SWL (W) Weight (H) Height

BIRTLEY LINTELS 130MM CAVITY WALLS

**WIDE INNER
100MM OUTER**

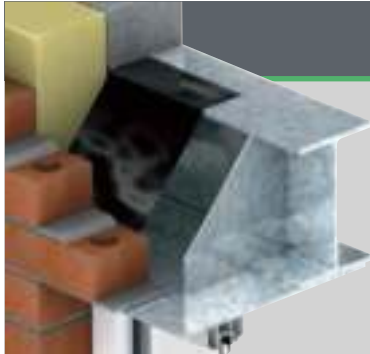

WIDE INNER

Cavity **130-145mm**
Outer Leaf **100mm**
Inner Leaf **125-140mm**

Lintel Shown: SX130/130

CAN'T FIND WHAT YOU'RE LOOKING FOR?

For further information or to ask us a specific question please contact our **technical team**

0330 404 9951

intel.technical@birtleygroup.co.uk

CB130/130 STANDARD DUTY

Not suitable for point loads or concrete floors.

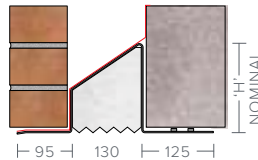

Length	750-1500	1650-2100	2250-2550	2700-3000	3150-3900
L (kN)	30	23	25	30	23
W (kg/m)	11.5	11.5	11.8	14.4	14.4
H (mm)	151	151	158	174	174

(L) Load SWL (W) Weight (H) Height

MD130/130 MEDIUM DUTY

Must have solid, fully jointed blockwork infill to inner leaf.

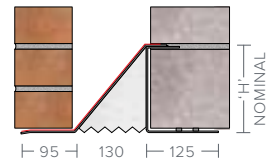

Length	750-3000	3150-3900
L (kN)	35	25
W (kg/m)	15.1	15.1
H (mm)	156	156

(L) Load SWL (W) Weight (H) Height

HD130/130 HEAVY DUTY

Must have solid, fully jointed blockwork infill to inner leaf.

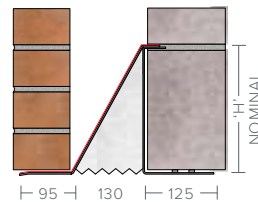

Length	750-1800	1950-2700	2850-3000	3150-3600	3750-3900	4050-4500	4650-4800	4950-5100
L (kN)	70	60	55	50	45	40	35	25
W (kg/m)	17.8	17.8	17.8	17.8	17.8	17.8	17.8	17.8
H (mm)	231	231	231	231	231	231	231	231

(L) Load SWL (W) Weight (H) Height

HDX130/130 EXTRA HEAVY DUTY

Must have solid, fully jointed blockwork infill to inner leaf.

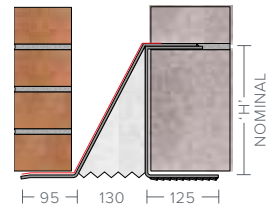

Length	750-2100	2250-3300	3450-4200	4350-4800	4950-5100
L (kN)	100	80	70	60	45
W (kg/m)	34.8	34.8	34.8	34.8	34.8
H (mm)	237	237	237	237	237

(L) Load SWL (W) Weight (H) Height

SX130/130 ULTRA HEAVY DUTY

203x133x30UB
Should be laterally restrained and propped during installation.

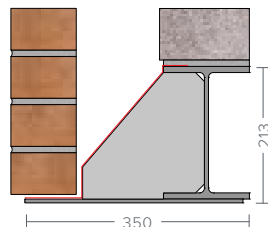

Length	750-4200	4350-4800	4950-5400	5550-5700	5850-6000	6150-6300	6450-6600
L (kN)	90	80	70	65	55	50	45
W (kg/m)	46	46	46	46	46	46	46
H (mm)	213	213	213	213	213	213	213

(L) Load SWL (W) Weight (H) Height

XHD130/130 EXTREME HEAVY DUTY

230x90x32PFC
Should be laterally restrained and propped during installation.

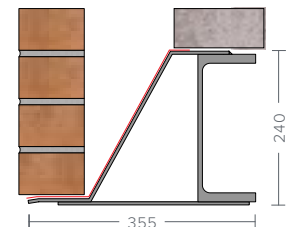

Length	750-4200	4350-4800	4950-5400	5550-6600
L (kN)	120	100	90	65
W (kg/m)	61.4	61.4	61.4	61.4
H (mm)	240	240	240	240

(L) Load SWL (W) Weight (H) Height

BIRTLEY LINTELS 130MM CAVITY WALLS

**100MM INNER
WIDE OUTER**



WIDE OUTER

Cavity **130-145mm**
Outer Leaf **125-140mm**
Inner Leaf **100mm**

Lintel Shown: SX125/130/100

CAN'T FIND WHAT YOU'RE LOOKING FOR?

For further information or to ask us a specific question please contact our **technical team**

0330 404 9951

intel.technical@birtleygroup.co.uk

CB125/130/100 STANDARD DUTY

Not suitable for point loads or concrete floors.

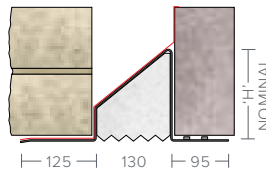

Length	750-1500	1650-2400	2550-3000	3150-3900
L (kN)	30	25	30	23
W (kg/m)	11.5	11.5	14.6	14.6
H (mm)	153	153	182	182

(L) Load SWL (W) Weight (H) Height

MD125/130/100 MEDIUM DUTY

Must have solid, fully jointed blockwork infill to inner leaf.

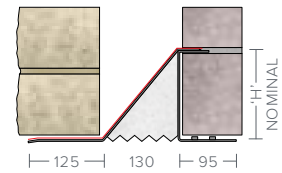

Length	750-3000	3150-3900
L (kN)	35	25
W (kg/m)	15	15
H (mm)	155	155

(L) Load SWL (W) Weight (H) Height

HD125/130/100 HEAVY DUTY

Must have solid, fully jointed blockwork infill to inner leaf.

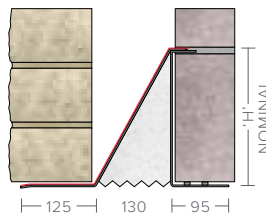

Length	750-1800	1950-2700	2850-3000	3150-3600	3750-3900	4050-4500	4650-4800	4950-5100
L (kN)	70	60	55	50	45	40	35	25
W (kg/m)	17.7	17.7	17.7	17.7	17.7	17.7	17.7	17.7
H (mm)	231	231	231	231	231	231	231	231

(L) Load SWL (W) Weight (H) Height

HDX125/130/100 EXTRA HEAVY DUTY

Must have solid, fully jointed blockwork infill to inner leaf.

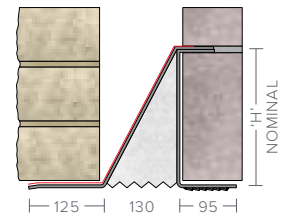

Length	750-2100	2250-3300	3450-4200	4350-4800	4950-5100
L (kN)	100	80	70	60	45
W (kg/m)	31.9	31.9	31.9	31.9	31.9
H (mm)	237	237	237	237	237

(L) Load SWL (W) Weight (H) Height

SX125/130/100 ULTRA HEAVY DUTY

203x133x30UB
Should be laterally restrained and propped during installation.

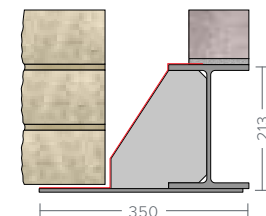

Length	750-4200	4350-4800	4950-5400	5550-5700	5850-6000	6150-6300	6450-6600
L (kN)	90	80	70	65	55	50	45
W (kg/m)	46	46	46	46	46	46	46
H (mm)	213	213	213	213	213	213	213

(L) Load SWL (W) Weight (H) Height

XHD125/130/100 EXTREME HEAVY DUTY

230x90x32PFC
Should be laterally restrained and propped during installation.

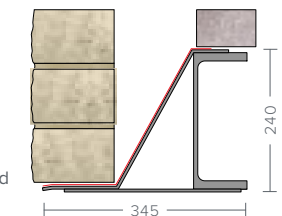

Length	750-4200	4350-4800	4950-5400	5550-6600
L (kN)	120	100	90	65
W (kg/m)	61.4	61.4	61.4	61.4
H (mm)	240	240	240	240

(L) Load SWL (W) Weight (H) Height

BIRTLEY LINTELS 150MM CAVITY WALLS

**100MM INNER
100MM OUTER**



STANDARD

Cavity **150-165mm**
Outer Leaf **100mm**
Inner Leaf **100mm**

Lintel Shown: XHD150

CAN'T FIND WHAT YOU'RE LOOKING FOR?

For further information or to ask us a specific question please contact our **technical team**

0330 404 9951

intel.technical@birtleygroup.co.uk

CB150 STANDARD DUTY

Not suitable for point loads or concrete floors.

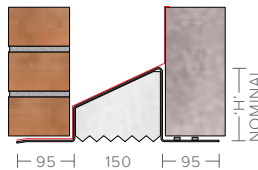

Length	750-1500	1650-1950	2100	2250-2700	2850-3300
L (kN)	20	20	20	25	30
W (kg/m)	8.3	10.1	10.4	11.5	14.4
H (mm)	112	117	124	153	177

(L) Load SWL (W) Weight (H) Height

MD150 MEDIUM DUTY

Must have solid, fully jointed blockwork infill to inner leaf.

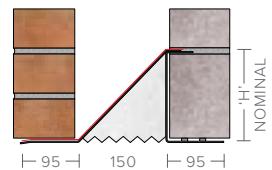

Length	750-1800	1950-3000	3150-3900
L (kN)	35	35	25
W (kg/m)	10.4	14.3	14.3
H (mm)	154	156	156

(L) Load SWL (W) Weight (H) Height

HD150 HEAVY DUTY

Must have solid, fully jointed blockwork infill to inner leaf.

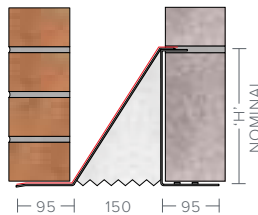

Length	750-1800	1950-2400	2550-2700	2850-3000	3150-3600	3750-3900	4050-4500	4650-4800	4950-5100
L (kN)	70	60	60	55	50	45	40	35	25
W (kg/m)	15.4	15.4	18.3	18.3	18.3	18.3	18.3	18.3	18.3
H (mm)	231	231	232	232	232	232	232	232	232

(L) Load SWL (W) Weight (H) Height

HDX150 EXTRA HEAVY DUTY

Must have solid, fully jointed blockwork infill to inner leaf.

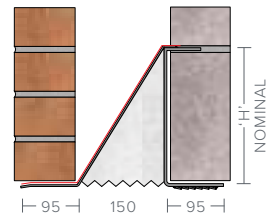

Length	750-2100	2250-3300	3450-4200	4350-4800	4950-5100
L (kN)	100	80	70	60	45
W (kg/m)	24	24	24	24	24
H (mm)	236	236	236	236	236

(L) Load SWL (W) Weight (H) Height

SX150 ULTRA HEAVY DUTY

203x133x30UB
Should be laterally restrained and propped during installation.

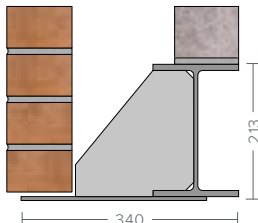

Length	750-4200	4350-4800	4950-5400	5550-5700	5850-6000	6150-6300	6450-6600
L (kN)	90	80	70	65	55	50	45
W (kg/m)	44.6	44.6	44.6	44.6	44.6	44.6	44.6
H (mm)	213	213	213	213	213	213	213

(L) Load SWL (W) Weight (H) Height

XHD150 EXTREME HEAVY DUTY

230x90x32PFC
Should be laterally restrained and propped during installation.

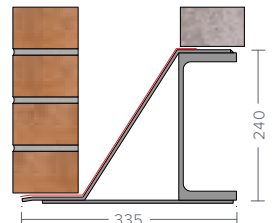

Length	750-4200	4350-4800	4950-5400	5550-6600
L (kN)	120	100	90	65
W (kg/m)	61.5	61.5	61.5	61.5
H (mm)	240	240	240	240

(L) Load SWL (W) Weight (H) Height

BIRTLEY LINTELS 150MM CAVITY WALLS

**WIDE INNER
100MM OUTER**



WIDE INNER

Cavity **150-165mm**
Outer Leaf **100mm**
Inner Leaf **125-140mm**

Lintel Shown: XHD150/130

CAN'T FIND WHAT YOU'RE LOOKING FOR?

For further information or to ask us a specific question please contact our **technical team**

0330 404 9951

intel.technical@birtleygroup.co.uk

CB150/130 STANDARD DUTY

Not suitable for point loads or concrete floors.

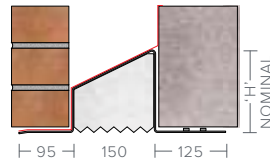

Length	750-2100	2250-2550	2700-3000	3150-3900
L (kN)	28	25	30	22
W (kg/m)	11.5	11.8	14.4	14.4
H (mm)	139	147	163	163

(L) Load SWL (W) Weight (H) Height

MD150/130 MEDIUM DUTY

Must have solid, fully jointed blockwork infill to inner leaf.

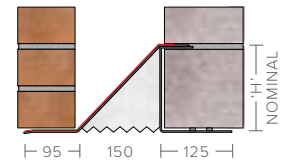

Length	750-3000	3150-3900
L (kN)	35	25
W (kg/m)	15.8	15.8
H (mm)	156	156

(L) Load SWL (W) Weight (H) Height

HD150/130 HEAVY DUTY

Must have solid, fully jointed blockwork infill to inner leaf.

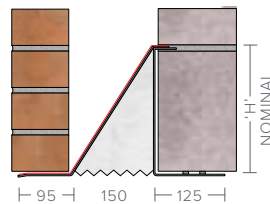

Length	750-1800	1950-2700	2850-3000	3150-3600	3750-3900	4050-4500	4650-4800	4950-5100
L (kN)	70	60	55	50	45	40	35	25
W (kg/m)	17.9	17.9	17.9	17.9	17.9	17.9	17.9	17.9
H (mm)	231	231	231	231	231	231	231	231

(L) Load SWL (W) Weight (H) Height

HDX150/130 EXTRA HEAVY DUTY

Must have solid, fully jointed blockwork infill to inner leaf.

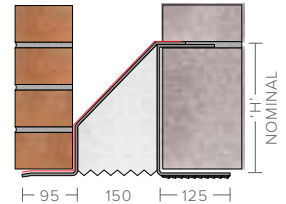

Length	750-2100	2250-3300	3450-4200	4350-4800	4950-5100
L (kN)	100	80	70	60	45
W (kg/m)	34.8	34.8	34.8	34.8	34.8
H (mm)	237	237	237	237	237

(L) Load SWL (W) Weight (H) Height

SX150/130 ULTRA HEAVY DUTY

203x133x30UB
Should be laterally restrained and propped during installation.

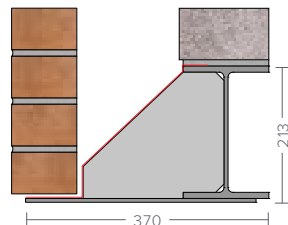

Length	750-4200	4350-4800	4950-5400	5550-5700	5850-6000	6150-6300	6450-6600
L (kN)	90	80	70	65	55	50	45
W (kg/m)	46	46	46	46	46	46	46
H (mm)	213	213	213	213	213	213	213

(L) Load SWL (W) Weight (H) Height

XHD150/130 EXTREME HEAVY DUTY

230x90x32PFC
Should be laterally restrained and propped during installation.

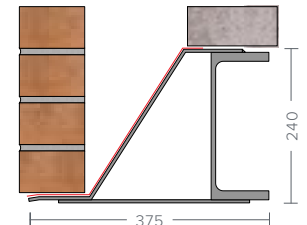

Length	750-4200	4350-4800	4950-5400	5550-6600
L (kN)	120	100	90	65
W (kg/m)	61.4	61.4	61.4	61.4
H (mm)	240	240	240	240

(L) Load SWL (W) Weight (H) Height

BIRTLEY LINTELS 150MM CAVITY WALLS

**100MM INNER
WIDE OUTER**



**CAN'T FIND WHAT YOU'RE
LOOKING FOR?**

For further information or to ask us a specific question please contact our **technical team**

0330 404 9951

intel.technical@birtleygroup.co.uk

CB125/150/100
STANDARD DUTY

Not suitable for point loads or concrete floors.

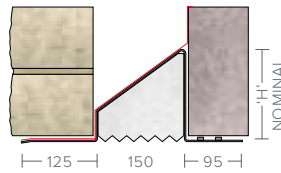

Length	750-1500	1650-2400	2550-3000	3150-3900
L (kN)	30	25	30	23
W (kg/m)	11.8	11.8	14.6	14.6
H (mm)	154	154	175	175

(L) Load SWL (W) Weight (H) Height

MD125/150/100
MEDIUM DUTY

Must have solid, fully jointed blockwork infill to inner leaf.

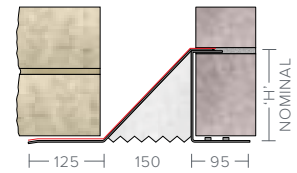

Length	750-3000	3150-3900
L (kN)	35	25
W (kg/m)	15.3	15.3
H (mm)	155	155

(L) Load SWL (W) Weight (H) Height

HD125/150/100
HEAVY DUTY

Must have solid, fully jointed blockwork infill to inner leaf.

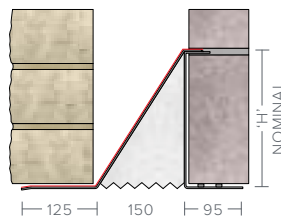

Length	750-1800	1950-2700	2850-3000	3150-3600	3750-3900	4050-4500	4650-4800	4950-5100
L (kN)	70	60	55	50	45	40	35	25
W (kg/m)	18	18	18	18	18	18	18	18
H (mm)	231	231	231	231	231	231	231	231

(L) Load SWL (W) Weight (H) Height

HDX125/150/100
EXTRA HEAVY DUTY

Must have solid, fully jointed blockwork infill to inner leaf.

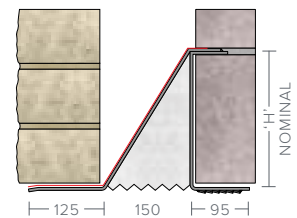

Length	750-2100	2250-3300	3450-4200	4350-4800	4950-5100
L (kN)	100	80	70	60	45
W (kg/m)	31.9	31.9	31.9	31.9	31.9
H (mm)	237	237	237	237	237

(L) Load SWL (W) Weight (H) Height

SX125/150/100
ULTRA HEAVY DUTY

203x133x30UB
Should be laterally restrained and propped during installation.

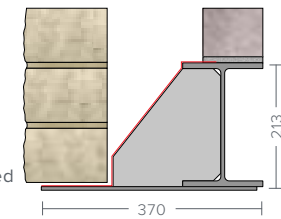

Length	750-4200	4350-4800	4950-5400	5550-5700	5850-6000	6150-6300	6450-6600
L (kN)	90	80	70	65	55	50	45
W (kg/m)	46	46	46	46	46	46	46
H (mm)	213	213	213	213	213	213	213

(L) Load SWL (W) Weight (H) Height

XHD125/150/100
EXTREME HEAVY DUTY

230x90x32PFC
Should be laterally restrained and propped during installation.

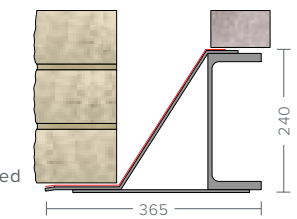

Length	750-4200	4350-4800	4950-5400	5550-6600
L (kN)	120	100	90	65
W (kg/m)	61.4	61.4	61.4	61.4
H (mm)	240	240	240	240

(L) Load SWL (W) Weight (H) Height

150

BIRTLEY LINTELS SOLID WALLS

**200-215MM
SOLID**



SOLID WALLS

200-215mm
Solid Masonry Wall

Lintel Shown: SBL200
2850mm +

SBL200

MEDIUM DUTY

Inner and outer leaves must be suitably tied.

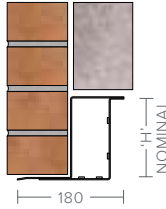

Length	750-2700	2850-3000	3150-3600	3750-4500	4650-5100
L (kN)	20	25	40	35	28
W (kg/m)	9.8	16.5	16.5	16.5	16.5
H (mm)	140	222	222	222	222

(L) Load SWL (W) Weight (H) Height

SBL200XHD

EXTRA HEAVY DUTY

Inner and outer leaves must be suitably tied.

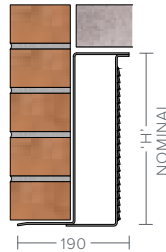

Length	750-3600
L (kN)	65
W (kg/m)	21.2
H (mm)	295

(L) Load SWL (W) Weight (H) Height

DC200HDX

EXTRA HEAVY DUTY

Inner and outer leaves must be suitably tied.

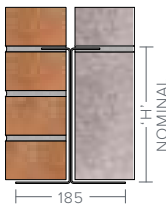

Length	750-2100	2250-3900	4050-4800	4950-5100
L (kN)	100	60	50	30
W (kg/m)	29	29	29	29
H (mm)	233	233	233	233

(L) Load SWL (W) Weight (H) Height

OB190

STANDARD DUTY

Inner and outer leaves must be suitably tied.

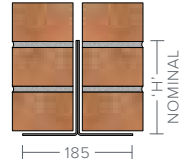

Length	750-1500	1650-2100	2250-3000
L (kN)	9	12	20
W (kg/m)	5.8	8.2	11.4
H (mm)	87	92	157

(L) Load SWL (W) Weight (H) Height

SBL200HD

HEAVY DUTY

Inner and outer leaves must be suitably tied.

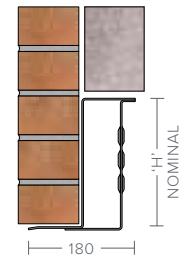

Length	750-2550	2700-3600	3750-3900	4050-4500	4650-5100
L (kN)	55	45	50	45	40
W (kg/m)	17.2	17.2	21.2	21.2	21.2
H (mm)	222	222	295	295	295

(L) Load SWL (W) Weight (H) Height

DC200

HEAVY DUTY

Inner and outer leaves must be suitably tied.

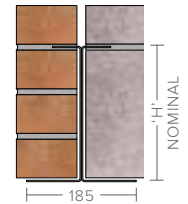

Length	750-2100	2250-2400	2550-3900	4050-5100
L (kN)	60	50	50	30
W (kg/m)	14.2	14.2	16.5	16.5
H (mm)	228	228	229	229

(L) Load SWL (W) Weight (H) Height

SW200

EXTREME HEAVY DUTY

Inner and outer leaves must be suitably tied.

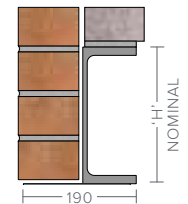

Length	750-4200	4350-4800	4950-5400	5550-6600
L (kN)	120	100	90	65
W (kg/m)	41.3	41.3	41.3	41.3
H (mm)	236	236	236	236

(L) Load SWL (W) Weight (H) Height

SOLID

BIRTLEY LINTELS EXTERNAL WALLS

100MM OUTER



EXTERNAL WALLS

100mm
Fair faced Masonry

Lintel Shown: EV100
2250-3000mm

LA STANDARD DUTY

Lintels above 1500mm must be propped.

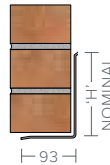

Length	750-1500	1650-1800	1950-2400	2550-3000	3150-3900
L (kN)	6	6	10	13	8
W (kg/m)	4.4	5.1	6.1	7.3	7.3
H (mm)	89	118	157	214	214

(L) Load SWL (W) Weight (H) Height

LAXHD EXTREME HEAVY DUTY

Lintels above 1500mm must be propped.

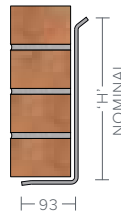

Length	750-3900
L (kN)	34
W (kg/m)	18
H (mm)	283

(L) Load SWL (W) Weight (H) Height

EV100HDX EXTRA HEAVY DUTY

Lintels above 3000mm must be propped.

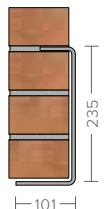

Length	750-3600	3750-4500
L (kN)	40	27
W (kg/m)	18	18
H (mm)	235	235

(L) Load SWL (W) Weight (H) Height

MBL LIGHT DUTY

Lintels above 1500mm must be propped.
For light duty applications e.g. meter boxes.

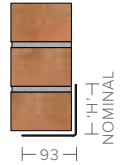

Length	750-900	1050-1350	1500-2100
L (kN)	2	4	5
W (kg/m)	2.3	2.9	4.1
H (mm)	52	87	92

(L) Load SWL (W) Weight (H) Height

LAHDX EXTRA HEAVY DUTY

Lintels above 1500mm must be propped.

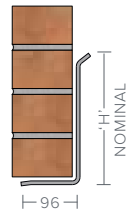

Length	750-3900
L (kN)	17
W (kg/m)	14.7
H (mm)	213

(L) Load SWL (W) Weight (H) Height

EV100 STANDARD DUTY

Lintels above 3000mm must be propped.



Length	750-1500	1650-2100	2250-3000	3150-3600	3750-4500	4650-5400
L (kN)	15	20	25	30	22	15
W (kg/m)	4.9	6.7	8.6	14.5	14.5	14.5
H (mm)	151	153	229	233	233	233

(L) Load SWL (W) Weight (H) Height

EV100XHD EXTREME HEAVY DUTY

Lintels above 3000mm must be propped.

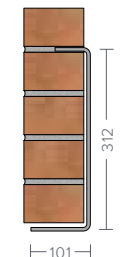

Length	750-4500
L (kN)	50
W (kg/m)	21.7
H (mm)	312

(L) Load SWL (W) Weight (H) Height

EXTERNAL

BIRTLEY LINTELS INTERNAL WALLS

100MM BLOCK



INTERNAL WALLS

100mm

Internal block walls
(plastered)

Lintel Shown: SB100
1650-2700mm



INTERNAL WALLS

140mm

Internal block walls
(plastered)

Lintel Shown: SB140
2580mm +

SB100 STANDARD DUTY

Insulated version available.



SB140 STANDARD DUTY

Insulated version available.

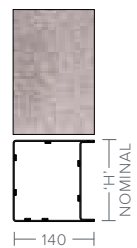

Length	750-1500	1650-1800	1950-2700	2850-3600	3750-4500	4650-4800	4950-5100
L (kN)	15	20	20	25	30	28	24
W (kg/m)	4.9	6.7	8.3	10.8	13	13	13
H (mm)	76	142	144	215	215	215	215

(L) Load SWL (W) Weight (H) Height

Length	750-2100	2250-2700	2850-3600	3750-4200	4350-4800	4950-5100
L (kN)	25	25	25	45	35	28
W (kg/m)	7.9	9.7	12.1	17.2	17.2	17.2
H (mm)	137	138	215	215	215	215

(L) Load SWL (W) Weight (H) Height

SB100HD HEAVY DUTY

Insulated version available.

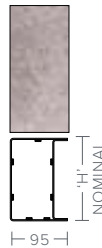

SB140HD HEAVY DUTY

Insulated version available.

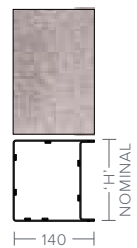

Length	750-1500	1650-2700	2850-3600	3750-4500	4650-4800	4950-5100
L (kN)	25	40	45	40	35	30
W (kg/m)	6.7	10.8	15.1	18.5	18.5	18.5
H (mm)	142	215	215	290	290	290

(L) Load SWL (W) Weight (H) Height

Length	750-1500	1650-2700	2850-3600	3750-4500	4650-4800	4950-5100
L (kN)	35	40	45	45	40	35
W (kg/m)	9.7	12.1	17.2	20.6	20.6	20.6
H (mm)	138	215	215	290	290	290

(L) Load SWL (W) Weight (H) Height

SB100HDX EXTRA HEAVY DUTY

Insulated version available.



SB140HDX EXTRA HEAVY DUTY

Insulated version available.

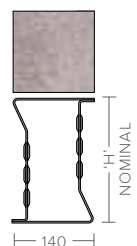

Length	750-1500	1650-2700
L (kN)	60	60
W (kg/m)	11.7	15.1
H (mm)	140	215

(L) Load SWL (W) Weight (H) Height

Length	750-1500	1650-2700
L (kN)	60	60
W (kg/m)	13.6	17.2
H (mm)	142	215

(L) Load SWL (W) Weight (H) Height

BIRTLEY LINTELS

INTERNAL WALLS/EAVES

Can't find what you're looking for?

Speak to our technical team
0330 404 9951

SB100XHD

EXTREME HEAVY DUTY

Insulated version available.
Loads based on 200mm bearing.



Length	750-2700	2850-3600
L (kN)	80	65
W (kg/m)	18.5	18.5
H (mm)	290	290

(L) Load SWL (W) Weight (H) Height

SB140XHD

EXTREME HEAVY DUTY

Insulated version available.
Loads based on 200mm bearing.

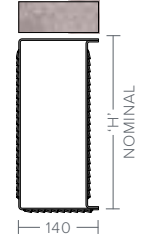

Length	750-2700	2850-3600
L (kN)	80	65
W (kg/m)	20.6	20.6
H (mm)	290	290

(L) Load SWL (W) Weight (H) Height

INT100

LIGHT DUTY

Suitable for non-loadbearing walls.

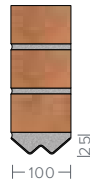

Length	900-1200
L (kN)	5
W (kg/m)	2.1
H (mm)	25

(L) Load SWL (W) Weight (H) Height

INT100HD

MEDIUM DUTY

Suitable for non-loadbearing walls.

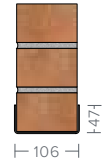

Length	750-1200	1350-2100
L (kN)	10	5
W (kg/m)	3.2	3.2
H (mm)	47	47

(L) Load SWL (W) Weight (H) Height



CBEV50

50-85MM CAVITY

Must be propped during installation to achieve loads. Requires fully bonded masonry and a continuous wall plate.

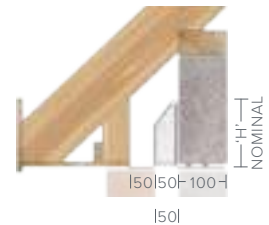

Length	750-1200	1350-1500	1650-1800	1950-2100	2250-2700
L (kN)	15	15	20	20	26
W (kg/m)	5.5	6.8	7.1	7.3	10.9
H (mm)	124	124	134	139	194

(L) Load SWL (W) Weight (H) Height

CBEV90

90-125MM CAVITY

Must be propped during installation to achieve loads. Requires fully bonded masonry and a continuous wall plate.

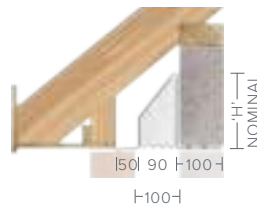

Length	750-2100	2250-2700	2850-3000	3150-3900
L (kN)	20	20	18	18
W (kg/m)	8.3	12	11.5	14
H (mm)	162	174	190	206

(L) Load SWL (W) Weight (H) Height

CBEV150

130-175MM CAVITY

Must be propped during installation to achieve loads. Requires fully bonded masonry and a continuous wall plate.



Length	750-1050	1200-1350	1500-1650	1800-2100	2250-2400	2550	2700-3000	3150-3900
L (kN)	15	15	15	19	19	19	19	19
W (kg/m)	5.8	5.9	7.3	8.3	10.1	10.9	11.8	14.4
H (mm)	97	102	102	132	141	157	181	197

(L) Load SWL (W) Weight (H) Height

EAVES

BIRTLEY LINTELS TIMBER FRAME

100MM OUTER



TIMBER FRAMES

100mm

Fair faced masonry

Lintel Shown: TF50

CAN'T FIND WHAT YOU'RE LOOKING FOR?

For further information or to ask us a specific question please contact our **technical team**

0330 404 9951

lintel.technical@birtleygroup.co.uk

TF50 STANDARD DUTY

Pinch batten must be used. Other cavity sizes available.

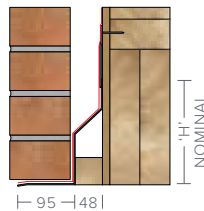

Length	750-1350	1500-1650	1800-2250	2400-3000	3150-3900
L (kN)	8	8	10	10	10
W (kg/m)	3.8	4.1	5	5.9	6.8
H (mm)	108	128	178	178	179

(L) Load SWL (W) Weight (H) Height

TF50HD HEAVY DUTY

Other cavity sizes available.



Length	750-1350	1500-1650	1800-2250	2400-3000	3300-3900	4050-4800
L (kN)	12	12	15	15	15	10
W (kg/m)	6.7	7.3	8.7	11.3	13.5	13.5
H (mm)	108	128	178	178	179	179

(L) Load SWL (W) Weight (H) Height

TF50HDX EXTRA HEAVY DUTY

Other cavity sizes available.

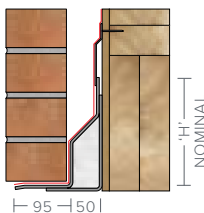

Length	750-2100	2250-3000	3150-3900	4050-4800
L (kN)	30	25	25	15
W (kg/m)	14.1	14.1	16.2	16.2
H (mm)	222	222	257	257

(L) Load SWL (W) Weight (H) Height



TF CLIP

Restraining clips (supplied) should be fixed to timber frame using 3 No 3.3mm Dia x 50 long galvanised nails. Clip should overlap lintel by 12mm as indicated by line on clip.

TF INSTALLATION

Lintels above 1200 long should be propped until lintel is fully loaded and brickwork has matured. Use horizontal timber spreader to avoid distorting lintel. Use single central prop for openings up to 2100.

For larger openings use multiple props (max spacing 1200).

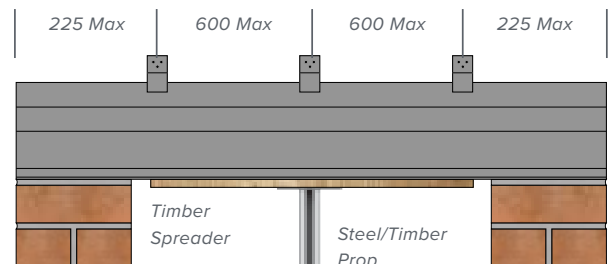

BIRTLEY LINTELS OPTIONS

Can't find what
you're looking for?

Speak to our technical team
0330 404 9951

Lintel Options

Sometimes a standard lintel just doesn't suit the architectural detailing of a building's design so a range of bespoke options are available on request.

RFF

The front flange of a lintel can be reduced in length. This is most useful when using a chamfered window head or narrow brick, when a standard flange would protrude.

To specify, add 'RFF' to the end of the lintel reference, followed by the projection of the flange e.g. CB50 RFF50.

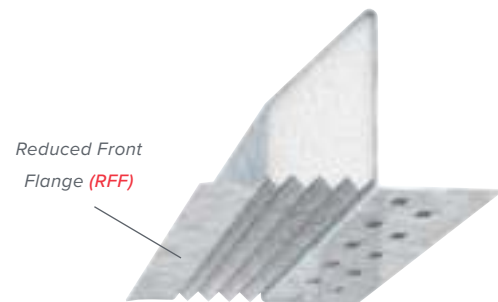

ND

To minimise the mortar bed thickness at the end bearings, e.g. when using stone heads and surrounds, the weather drip on the front flange of the lintel can be omitted.

To specify, add 'ND' to the end of the lintel reference e.g. CB50 ND.

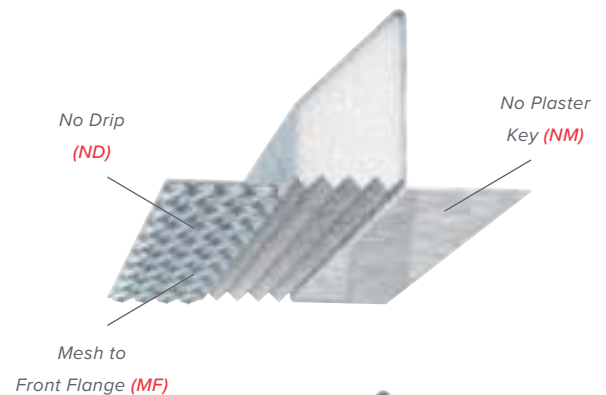

MF

A mesh can be welded to the underside of the front flange as a key to allow a rendered soffit. As the lintel is galvanized after the mesh is attached, it doesn't compromise the integrity of the lintel.

To specify, add 'MF' to the end of the lintel reference e.g. CB50 MF.

NM

Where the inner leaf of a cavity wall is fair-faced and the inner flange of the lintel is not plastered, the plaster key on this flange can be omitted.

To specify, add 'NM' to the end of the lintel reference e.g. CB50 NM.

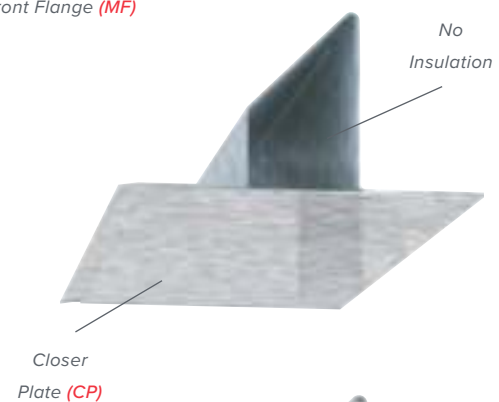

CP

Where the underside of the lintel is completely exposed, e.g. porches, driveways, etc., a closer plate can be welded prior to galvanizing to provide a neat, aesthetically pleasing finish to the soffit of the lintel.

To specify, add 'CP' to the end of the lintel reference e.g. CB50 CP.

ST

Inner and outer leaf flanges can be staggered to allow for uneven coursing. Please contact our Technical Department for further information.

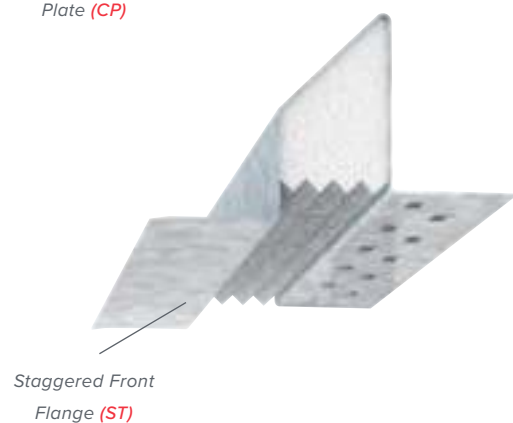

BIRTLEY LINTELS BESPOKE DESIGNS

**Need technical
advice?**

Speak to our technical team
0330 404 9951

Using the same manufacturing process as our standard lintel range, our bespoke lintels are hot-dip galvanized after manufacture to ensure total protection against corrosion.

Bespoke Designs

Our in-house team of engineers are happy to consider any project no matter how complex the lintels may seem, however the following shapes are most common.

To enquire about a purpose made lintel, please contact our technical department, or use the enquiry submission form at birtleylintels.co.uk

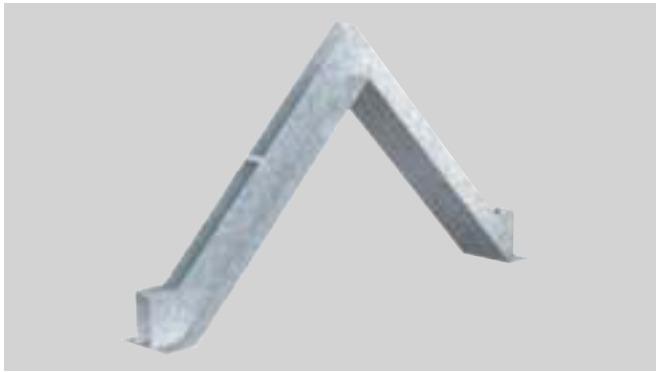

Apex Arch Lintel

Available in single or multi-leaf versions.
Information required:
Wall construction, Clear Span, Arch rise.



Gothic Arch Lintel

Available in single or multi-leaf versions.
Information required:
Wall construction, Clear Span, Arch rise, Radius.

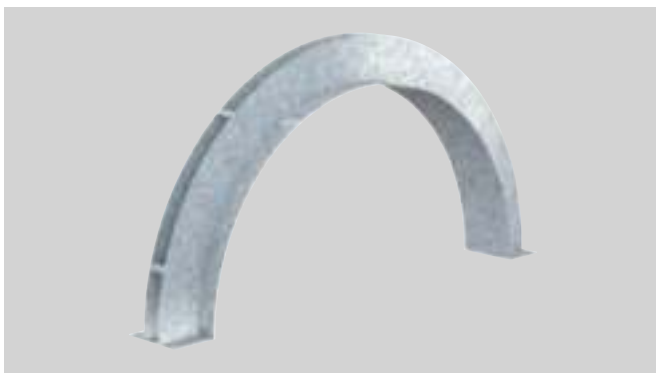

Semi-Circular Arch Lintel

Available in single or multi-leaf versions.
Information required:
Wall construction, Clear Span/diameter.

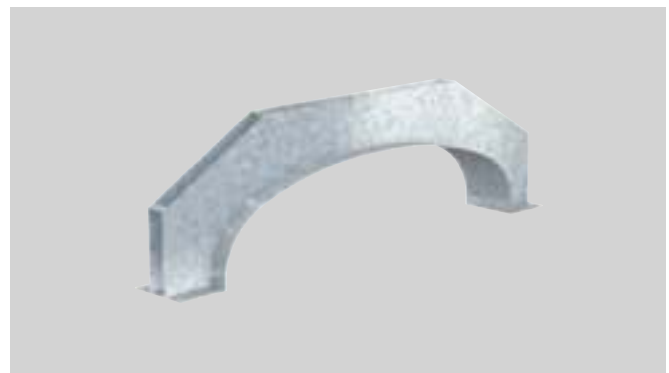

Three Centred Arch Lintel

Available in single or multi-leaf versions.
Information required:
Wall construction, Clear Span, Arch rise, Mid-Radius, End-Radius.

BIRTLEY LINTELS BESPOKE DESIGNS

Can't find what
you're looking for?

Speak to our technical team
0330 404 9951

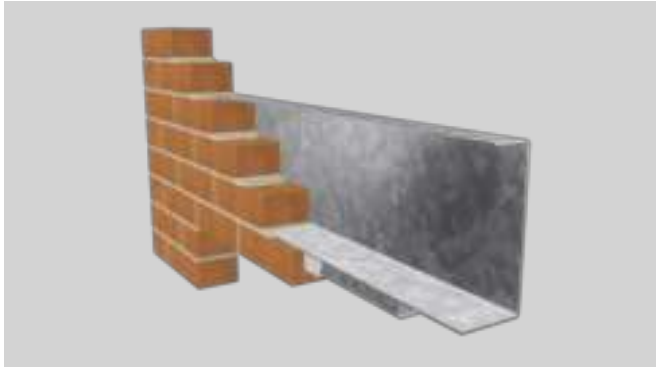

Brick Slip Feature Lintels

Brick slip feature lintels are one-piece units that are used on-site to replicate complex and time-consuming brickwork features. These specialist products offer a quick and cost-effective solution to expensive design features such as arches and circular requirements.

We have the capability to design and manufacture unique sizes and shapes to ensure that the finished product meets the aesthetics of your project as well as the load-bearing requirements.

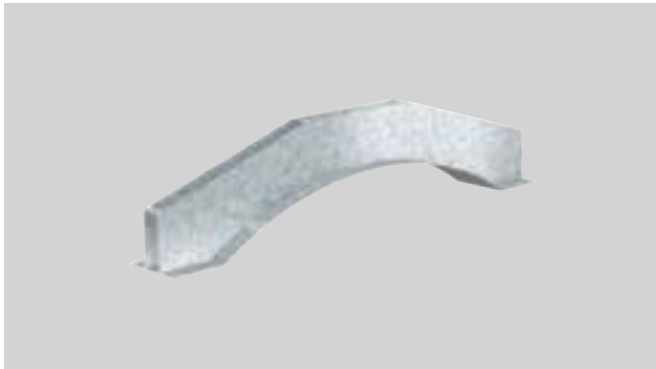

Segmental Arch Lintel

Available in single or multi-leaf versions.

Information required:

Wall construction, Clear Span, Arch rise, Radius.



Mitred Lintel

We offer a bespoke design service for mitred and bay lintels to suit any angle, load or application. Mitred lintels can be bolted or welded together, and are customisable to each customer's needs. A full set of architectural drawings must be submitted to our Technical Department with each enquiry.

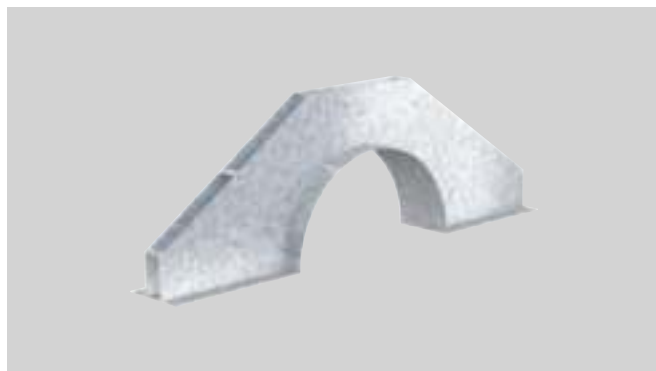

Venetian Arch Lintel

Available in single or multi-leaf versions.

Information required:

Wall construction, Clear Span, Arch diameter (span)



Curved-on-Plan Lintel

Radius lintels are used for openings within a curved wall. They usually require an increased end bearing and careful design consideration.

A full set of architectural drawings must be submitted to our Technical Department with each enquiry.

BIRTLEY LINTELS BALCONIES

**Need technical
advice?**

Speak to our technical team
0330 404 9951

Outstanding Style, Safety & Economy

The versatile Birtley range of 'Juliet' Balconies offers eight attractive and practical styles to choose from plus further 'custom-design' options. Their sturdy construction delivers uncompromised safety and all are hot-dip galvanized for maximum durability. Installation is quick and simple offering you a truly economical and versatile solution that can be easily 'built-in' to your design schemes.

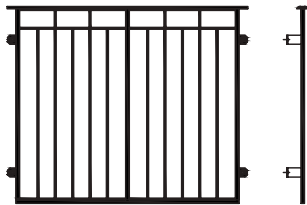

Sorrento

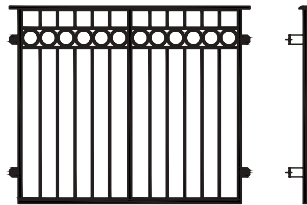

Roma

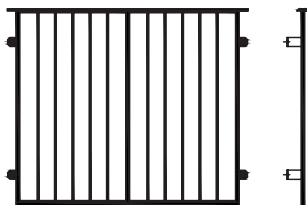

Verona

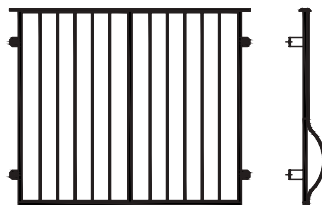

Pisa



Napoli

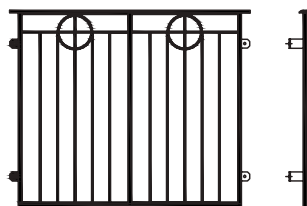

Siena



Milano

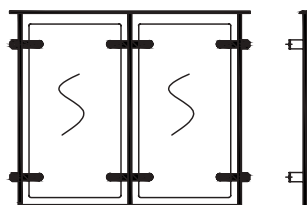

Firenze (Glazed)

Features

- Hot-dip galvanized for complete durability
- Optional powder coating
- Available in 3 sizes, (2, 3 & 4 panels)
- Choice of 8 infill panels
- Dimensions meet Building Regulations and NHBC requirements
- Frames and infill panels are stocked at Birtley for fast turnaround and allow for modular construction
- Supplied with protective covering to be removed after installation
- Special designs also available
- Balconies can be face fixed, using expanding bolts or chemical anchors. Alternate fixing methods available for render or tile-hung finishes.

Approximate Weights

- 2 panels: 34kg
- 3 panels: 50kg
- 4 panels: 67kg

BIRTLEY LINTELS ACCESSORIES

Can't find what
you're looking for?

Speak to our technical team
0330 404 9951

In order to improve the appearance of any window opening, we offer a range of PVC ancillaries which can be used with any standard Birtley lintel.

Archformer

Supports arched soldier course over standard door and window openings. Can be used with all standard external wall lintels.

Span	Opening Width	Rise
475	450-500	75
575	550-600	75
625	600-650	75
675	650-700	75
775	750-800	75
925	900-950	75
1025	1000-1050	75
1075	1050-1100	75
1125	1100-1150	75
1225	1200-1250	75
1375	1350-1400	75
1525	1500-1550	75
1575	1550-1600	75
1675	1650-1700	75
1775	1750-1800	75
1925	1900-1950	150
2025	2000-2050	150
2125	2100-2150	150
2225	2200-2250	150
2375	2350-2400	150
2425	2400-2450	150
2725	2700-2750	150
2975	2950-3000	150
3325	3300-3350	150

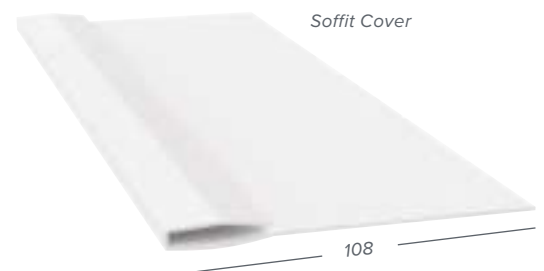
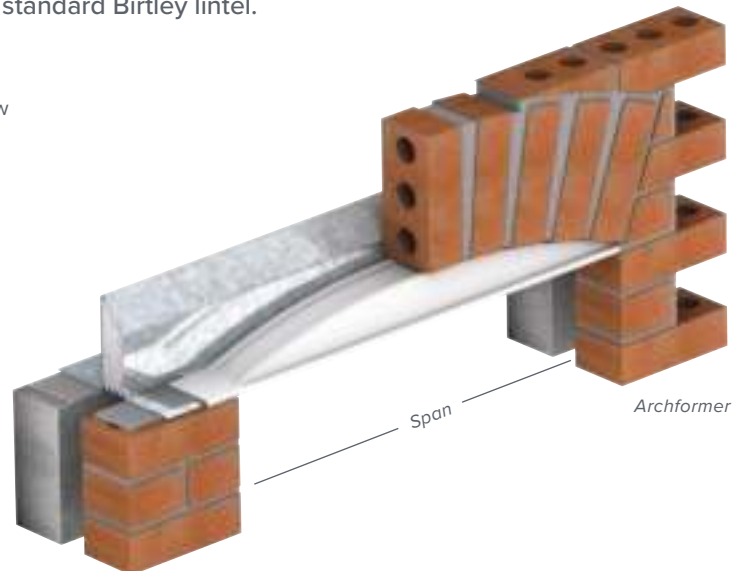

Soffit Cover

Manufactured from UPVC, the soffit cover fits over the front flange of standard lintels to provide an aesthetically pleasing finish to the exposed soffit of the lintel.

Lengths Available
900
1200
1500
1800
2100
2400
2700
4500

Soffit Covers and Archformers are available in white as standard.

Alternative colours are available, please contact

BIRTLEY LINTELS MASONRY SUPPORT

Need technical
advice?

Speak to our technical team
0330 404 9951

BAT Windpost Systems

BAT Windposts are designed to offer an alternative, cost effective method of providing the additional stiffness that a masonry wall requires as specified by the Structural Engineer.

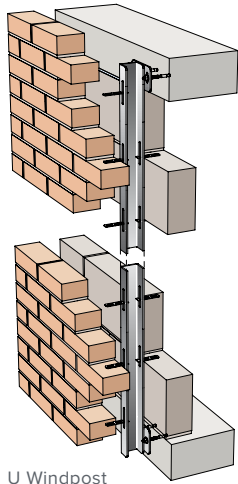

U Windpost

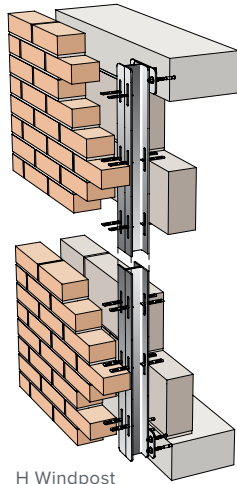

H Windpost

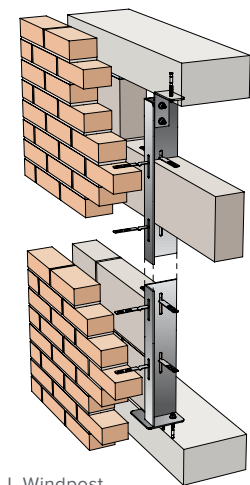

L Windpost

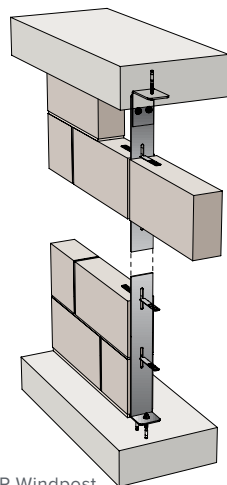

SP Windpost

Windpost Types

Four types of BAT Windposts are manufactured in a range of section sizes and steel thicknesses to withstand applied wind loadings. Base and top fixing configurations can be specified to allow for varying methods of construction and loading requirements.

U Section

U Section Windposts fit within the wall cavity and normally span between floor structures.

H Section

H Section Windposts serve the same purpose whilst allowing for heavy duty applications. Both U and H windposts leave the inner leaf of the cavity wall undisturbed.

L Section

L Section Windposts are designed to minimise intrusion into the cavity. One leg of the post is built into the inner leaf blockwork and tied with wall ties to both leaves to minimise any possible movement of the structure.

Spine Posts

Spine Posts are generally used for internal fair-faced walls. The post is a flat plate that can be built between blockwork panels and does not protrude beyond either finished face. Posts are usually 20mm narrower than the wall width with any additional load requirements provided for by an increase in the thickness of the post. Blockwork is tied through the post, the design allowing for the inclusion of debonded movement ties if required.

Windpost Wall Ties

All BAT Windposts are supplied with the correct number of wall ties and fixings. All wall ties comply with BS EN 845-1 Specification for ancillary components for masonry - Part 1.1.

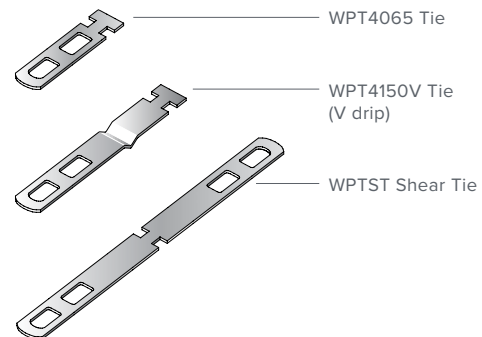

BAT Bracket Support Systems

Masonry support systems provide the method of controlling the uninterrupted height of masonry panels and accommodating differential vertical movement between masonry cladding and framed structures.

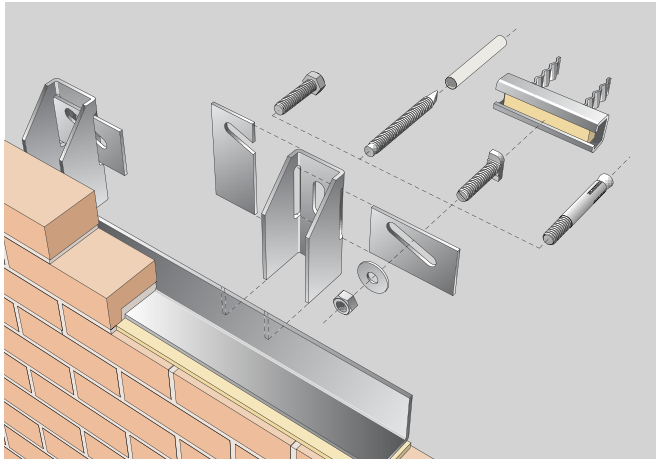

BAT Masonry Support

BAT Masonry Support is a range of bespoke systems designed to carry masonry cladding fixed to steel or concrete structures.

- BAT Bracket and BAT Angle Support Systems can be tailored to meet customer's design and engineering considerations.
- The BAT Angle Support Systems can carry up to 9m of brickwork and accommodate various cavity widths.
- Individual bracket supports, suspended masonry, top hung brackets and curved angles can be specified.
- The BAT Stone Support System complies with BS 8298 and is designed to suit natural stone cladding in a range of sizes and thickness.

Please contact us for further information.

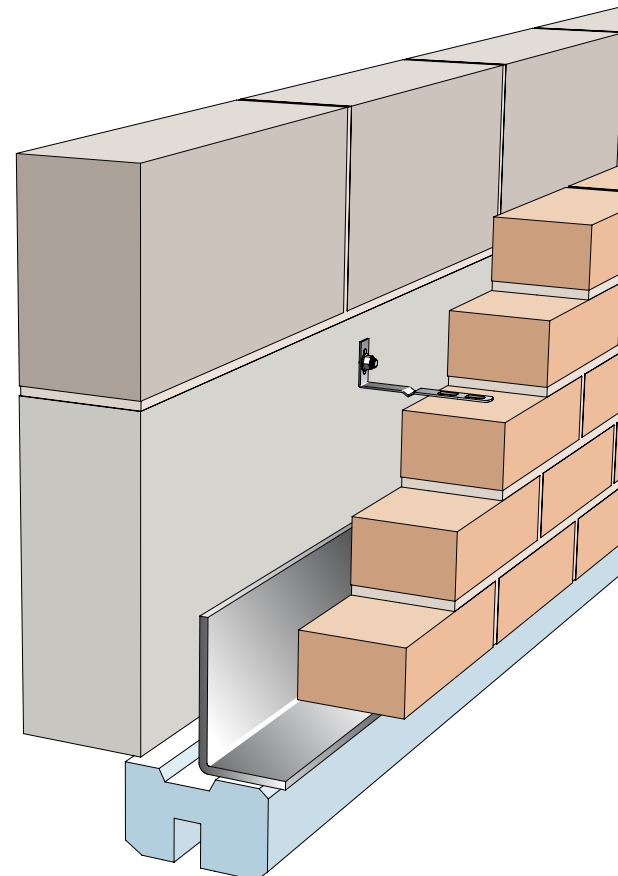
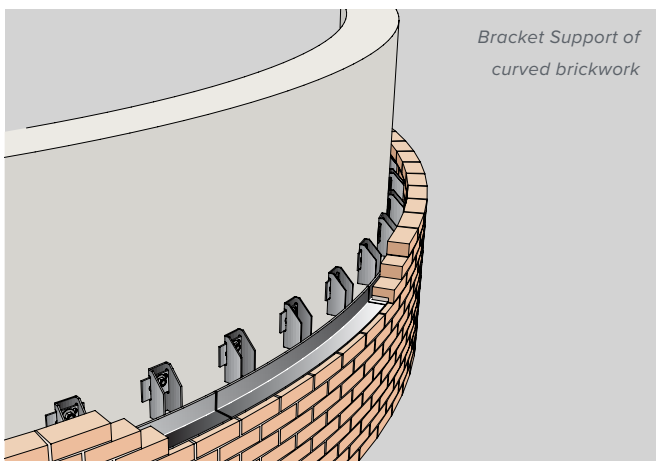
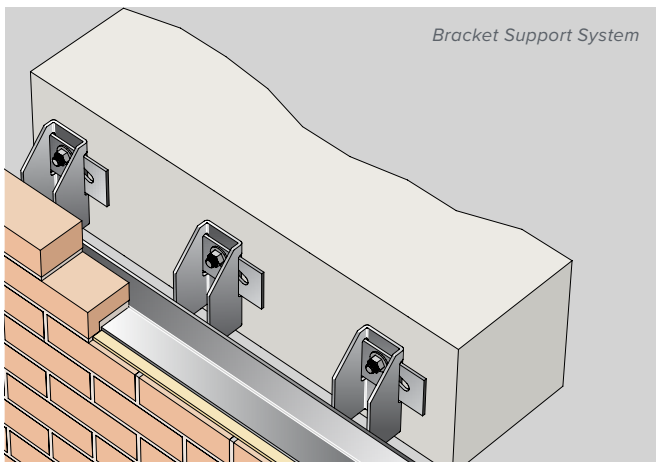

REGULATIONS INSTALLATION

**Need technical
advice?**

Speak to our technical team
0330 404 9951

General Installation Guidance

- Before attempting to install any lintel, please ensure that it is of the correct type, length, and is free from defects or damage. Do not attempt to cut or modify any lintels without prior approval and/or guidance from our Technical Department.
- Steel lintels should be installed with a minimum 150mm end bearing at each end. There are exceptions where 100mm is sufficient, though this should be confirmed by our Technical Department or a qualified structural engineer. Extended bearings may also be necessary for purpose made lintels, though this is clearly indicated during the design process.

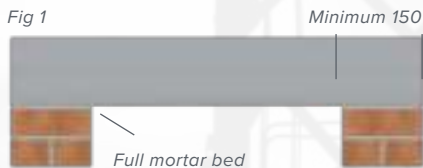

- Lintel bearings should be constructed from full, uncut masonry units, of sufficient strength to support the imposed loads. Concrete padstones may be required where the end reactions are high and low strength masonry units are used.
- Lintels should always be fully bedded on bricklaying mortar, which should be allowed sufficient time to cure before adding load to the lintel. Propping may be used to facilitate a faster construction process or higher rate of lift. Propping, unless otherwise specified, should be carried out at the discretion of the contractor, and with reference to the recommendations of BRE's good building guide issue 1, 10 & 15. Props should be installed after the initial masonry load has been applied and left in situ until all masonry/roof loads are in place.

- Inner and outer leaves (where applicable) should be raised equally to prevent eccentric loading during construction. Masonry should be laid on a consistent mortar bed with perpend joints fully filled. Masonry should be allowed to cure before any roof or floor loads are applied.
- Propping is mandatory for some external wall and timber frame lintels – Details can be found on the appropriate product pages.
- Once laid, the lintel should be levelled along its length (1) and width (2) using a spirit level or other suitable levelling device.

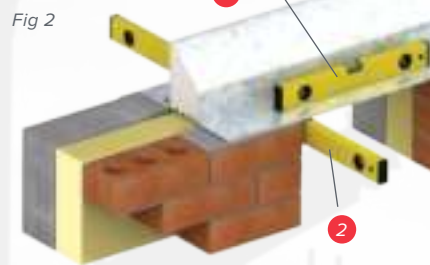

- Make sure that cavity width limits are not exceeded and that masonry does not overhang lintel flanges by more than 25mm (NHBC). Masonry overhang can be increased in certain circumstances. Please contact our Technical Department for further guidance.
- Lintels intended for external walls must project beyond the window head to prevent water ingress. Window frames should be sealed to the underside of the lintel using a suitable frame sealant when appropriate.

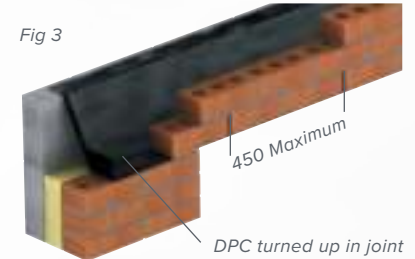

All External & Cavity Walls

- A cavity tray must be used over all lintels. Where a DPC is used, it must be turned up into a perpend joint or be used with proprietary stop ends. Weep vents must be used at a maximum 450mm interval, with a minimum of two per opening. See fig 3.

CB / Eaves

- Point loads and floor joists should not bear directly onto the lintel. A full course of bonded blockwork is required between structural members and the lintel flange. Where joists are at the same level as the flange, a proprietary joist hanger can be used to transfer the load to a course above. Eaves lintels require a continuous wall plate bedded onto fully bonded/cured masonry, and propping to prevent rotation.

Open Back / Heavy Duty

- Where a lintel is open-backed e.g. HD/ HDX, it must be fully filled with bonded masonry, ensuring that it is built tightly against the vertical face of the lintel. All masonry must be fully cured before imposing concrete floor loads.
- Precast concrete floor units must be laid on a full bed of mortar, and should be placed carefully to avoid shock loading.

REGULATIONS

HEALTH & SAFETY

Can't find what
you're looking for?

Speak to our technical team
0330 404 9951

Health & Safety

A practical, common sense approach should be adopted by personnel handling lintels and steel products. A maximum of 25kg should be carried by a single person.

If possible, mechanical lifting aids should be used in place of manual handling. All lintels should be considered heavy with the possibility of sharp edges. A practical risk assessment should be carried out before attempting to lift, push, pull or drag the product. Personal Protective Equipment (PPE) must be worn and should, as a minimum, include gloves, safety boots and hard hat.

Lintel and steel products should be installed by appropriately skilled and qualified tradesman following the installation instructions as detailed in this technical guide.

COSHH

In their finished state, lintels and steel products in general do not present a health hazard by inhalation, ingestion or contact. They are therefore considered non-hazardous under normal conditions of use, as determined by COSHH regulations 2002.

We do not recommend modification of these products once manufactured, but under certain circumstances minor modifications may be allowed. This may involve processes such as burning, welding, cutting or grinding which can result in vaporizing of the zinc metal and/or generation of airborne particles which may present hazards. These operations should be performed in well-ventilated conditions or with local exhaust ventilation. Exposure limits are as recommended by the UK Health & Safety executive and users should refer to guidance note EH40:2005 for the information on these limits. Suitable personal protective equipment should be worn at all times.

Disposal

Mild and Stainless Steel is 100% recyclable. Please contact your local recycling centre/scrap metal merchant for more information.

Handling

- Lintels should be stacked on battens of seasoned dry timber (non-resinous), extruded rigid plastic, or placed on purpose made steel racking.
- Circulating air flow around each lintel will prevent any build-up of moisture on the lintels, and reduce the likelihood of wet storage stain for newly galvanized products.
- The stacked weight distributed on a lintel or pack of lintels must never exceed the load capacity of the lintels. The loading on each 2" wide stacking batten should not exceed 750 kg.
- Lintel packs should never be lifted by the banding around them.
- Lintels should be arranged so that stacks of lintels are stable and safe for personnel working in the vicinity.
- Where ground conditions are soft and there is any significant gradient, it is advisable to stack lintels no more than 3 rows high.
- Care should be taken to wear gloves to avoid cuts and abrasions on any sharp points that may be present on cut edges of the lintel.

Maintenance

Once installed, lintels are usually maintenance free for the life of the galvanized coating. More details can be found at the beginning of this brochure. If the coating does require maintenance or repair, a suitable exterior metal paint system should be used and applied in accordance with the manufacturer's recommendations.

REGULATIONS COMPLIANCE

**Need technical
advice?**

Speak to our technical team
0330 404 9951

Product Standards

EN845-2:2013 Specification for ancillary components for masonry Part 2: Lintels.

EN1090-1:2009+A1:2011 Execution of steel structures and aluminium structures Part 1: Requirements for conformity assessment of structural components.

BS EN ISO 3834-2/3:2005 Quality requirements for fusion welding of metallic materials. EN ISO 13920:1997 Welding. General tolerances for welded constructions.

BS EN 13163:2012+A1:2015 Thermal insulation products for buildings. Factory made expanded polystyrene (EPS) products.

Fabricated Items

Since 1st July 2014, it has been a requirement that steel fabrications for structural use are CE marked to EN 1090. This standard ensures that manufacturers operate a strict welding quality management system, with all operatives fully qualified to carry out specific connections using the materials specified. Our processes, procedures and qualifications are assessed on an annual basis by BSI to ensure that quality standards remain consistently high. Our accreditation covers structures and fabrications up to and including Execution Class 2.



Testing

Our standard range of lintels to BS EN 845-2 has been subject to structural testing in accordance with BS EN 846-9:2000 and previously BS5977-2. All structural testing has been carried out independently by Lucideon Structures Laboratory (NB:0013) and The University of South Wales (NB:1014). Fire tests were carried out in accordance with BS 476 by Exova Warrington Fire (NB:0249).

Quality Systems

BS EN ISO 9001:2008/2015 BSI Accredited Quality management system.



BS EN ISO 14001:2004/2015 BSI Accredited Environmental management systems.



CE Marking

Since 1st July 2013, it has been a legal requirement that any construction product under the scope of a Harmonised European Standard (hEN) or European Technical Approval (ETA) must be CE marked.



The significance of CE marking is in its declaration of conformance to the full normative text of the product standard which relates to all essential requirements of the EU Construction Products Directive, and more recently, the Construction Products Regulation (No.305/2011). CE marking can't be superseded or conflicted by any other 3rd party accreditation and is the primary assessment criterion of product conformity as used in the Building Regulations document 7 and by the NHBC.

A requirement of compliance is providing a declaration of performance certificate (DoP) which contains the essential characteristics as dictated by the hEN or ETA, for each individual product type. DoPs are available to download via our website birtleylintels.co.uk.

Kitemark

In addition to statutory requirements, various ranges are also accredited to carry the BSI kitemark. This means that our processes are monitored and structural audit tests carried out on a regular basis to ensure that our lintels are still as safe as when they were first developed.



All accreditations and other compliance details are correct at time of going to print. (Jan 17). Please refer to website for full details.

REGULATIONS GLOSSARY

Can't find what
you're looking for?

Speak to our technical team
0330 404 9951

Lintel

A structural member or beam which spans an opening in a wall.

Schedule

A dwelling specific bill of quantities as specified by Birtley's Technical Dept.

Bearing

The portion of supporting wall onto which the lintel sits.

Span

The clear opening between lintel support bearings.

Effective Length

The distance between the centre point of each bearing.

UDL

Uniformly Distributed Load. A constant line load for a single leaf over the effective length of the lintel.

Partial UDL

A UDL for a portion of the effective length.

Point Load

A load imposed directly onto a lintel by a single structural member.

Dead Load

This is the sum of all permanent loads supported by the lintel. It is the self-weight of all structural and non-structural elements which form part of a finished building.

Live Load

Variable actions which are imposed on the building by its inhabitants/furniture or the weather/snow etc.

Deflection

The vertical displacement of a lintel compared with its unloaded position. For a UDL, deflection is measured at the mid-point of the span, at the mid-point of the flange.

Safe Working Load

The total uniformly distributed load which a lintel should support, at a specified load ratio, which incorporates a safety margin against structural failure and excessive deflection. This relates to Serviceability Limit State design.

FEA

Finite Element Analysis is a computerized method for simulating how a product reacts to real-world forces.

SAP

The Government's Standard Assessment Procedure for Energy Rating of Dwellings.

Fabric

The structural materials, cladding, insulation and finishes which enclose the internal spaces of a dwelling i.e. those which separate inside from out.

ACD

Accredited Construction Details as calculated by a person with suitable expertise and experience using the guidance set out in BR 497 and BRE IP 1/06.

Temperature Factor

The minimum internal surface temperature divided by the difference in temperature between inside and outside. This should exceed 0.75 to minimise the risk of mould growth.

CAD

Computer Aided Design

Supergalv

A Hot-dip Galvanized coating, 65 microns to EN1461

Ultragalv

A Hot-dip Galvanized coating, 150+ microns to EN1461

Corrosion Rate

The thickness of zinc consumed per annum based on location, as determined by the Atmospheric Corrosion Rate of Hot-Dip Galvanizing Map - © Galvanizers Association



Birtley Group

STRENGTH THROUGH QUALITY

One Group. Four Outstanding Brands.



Mary Avenue, Birtley, County Durham DH3 1JF United Kingdom

0330 404 9951 | lintel.sales@birtleygroup.co.uk | www.birtleylintels.co.uk

The particulars of this brochure are for guidance only. We operate a policy of continuous improvement and individual features may vary from time to time. Precise information should always be requested from our technical department. Birtley Group cannot be held responsible for any errors or omissions contained in this brochure. Birtley Group 020217.