

Stadium



PRODUCT GUIDE

VENTILATION
FLEXI TUBS & BUCKETS

GARDENING
HARDWARE

PLUMBING & DRAINAGE
PLASTERING & DECORATION

STADIUM BUILDING PRODUCTS

ABOUT US

Stadium Building Products are regarded as a market leading supplier for ventilation and building products. Stadium have been supplying many of the industry's top retailers with high quality, innovative products for over 100 years.

At Stadium Building Products we have a wealth of knowledge in designing and developing quality products with our in-house design team. With innovation being at the forefront of what we do, we are constantly adapting to meet the industry's needs. We offer a wide range of products, which is complimented by our customer service team who are always willing to help find the right solution for your needs.

We have the additional benefit of support from our global parent company, Flambeau Inc. Flambeau have over 70 years of experience in plastics manufacturing that we have leveraged in the UK market. We are able to offer a diverse range of products and services from tooling design for injection and blow moulded thermoplastic components to contract manufacturing of complete assemblies. Our vast warehouse and distribution facilities mean we are able to distribute globally and have an enviable flexibility with our product ranges and design capabilities.

HOW TO ORDER

Ordering is easy, whether you are a large scale or independent retailer. You have options to order via EDI or e-mail. Whichever way you choose, we aim to make ordering as easy as possible and our customer service team are always there to help should you need them.

You will need to have an account set up to place orders, which you can do by filling out a simple account form.

DELIVERY

We know lead times are essential. Our standard delivery time is 3-5 days, but we also offer an express next day delivery service. We aim to accommodate our customers' needs wherever possible, all you have to do is ask.

OUR CONTACT DETAILS

T: 01843 854002

E: stadium@flambeau.com

W: www.stadiumbuildingproducts.com



Ventilation

- 3 Guide to Ventilation
- 4 'Black Hole' Ventilation
- 5-6 'Black Hole' Ventilator Kits
- 6-7 Core Drill Ventilator Kits
- 8 Airbrick Ventilator Kits
- 9 Trickle Ventilators
- 9 Cavity Liners & Extension Tubes
- 10 Hit & Miss Ventilators
- 10-13 Louvre Ventilators
- 13 Face Fitting Ventilators
- 14 Flush Fitting Ventilators
- 14-15 External Cowls
- 16 Airbricks
- 17 Through Floor Ventilators
- 17 Mini Ventilators
- 17 Soffit Ventilators
- 18 Extractor Fans
- 18-20 Ducting

Rhino Flexi Tubs, Buckets & Bins

- 22 Rhino Flexi Tubs
- 23-24 Buckets
- 24 Galvanised Buckets
- 24 Tuff Tub
- 24 Dustbins

Gardening

- 26 Rhino Water Butt
- 26 Rhino Easi Can
- 26 Garden Hoses & Accessories

Hardware

- 27 Toolboxes
- 27 Funnels
- 27 Luggage Elastics
- 27 Roofing Washers
- 28 Plumbing Mat
- 28-29 Storage Boxes

Plastering & Decoration

- 30 Mixing Trays
- 30 Plasterers' Buckets & Baths
- 30-31 Plasterers' Accessories
- 31 Paint Kettles

Plumbing & Drainage

- 32 Pipe Clips
- 32-33 Cistern Floats
- 33-34 Traps & Air Admittance Valves
- 34 Waste Pipes
- 34 Pan Connectors
- 34-35 Plumbing Accessories
- 35 Flush Pipes
- 35 Gully Grids & Drain Covers
- 35-36 Gutter & Balloon Guards
- 36 Drain Rods

VENTILATION FOR COMBUSTION APPLIANCES

Stadium Ventilation is a name you can trust. Our products are specified and used by local authorities, housing associations and Corgi installers.

Providing the correct ventilation for combustion appliances is essential to ensure more efficient operation and safe combustion. A combustion appliance is usually a gas, oil or solid fuel burning appliance such as a boiler, fire, stove, warm air heater or cooker (for cooking or heating).

These appliances not only burn fuel but use oxygen in air combustion. If sufficient fresh air is not provided then the unit will use the available oxygen from the air in the room. If the supply to the appliance is inadequate, the flue will fail to clear all of the combustion products and some will spill into the room itself. Ventilating rooms containing combustion appliances is essential and often additional ventilation is required.

Prior to installation, detailed advice should be sought from a registered installer.

This information is a guide only.
Always refer to current Building Regulations.

FREE AREA

Free area is achieved by measuring the smallest apertures of a vent or grille to calculate the air flow. For a louvre, the areas should be measured at right angles to the blades or vanes. For an air vent assembly, the free cross-sectional area of the most restrictive component in an assembly should be used to calculate the free area.

For more information refer to the Free Area calculator on our website.

OPEN FLUED & FLUELESS APPLIANCES

Ventilation for flueless appliances must be direct to the outside of the building. However, ventilation for open flued appliances (which draw their combustion air from the room or space into which it is installed) should be direct to the outside of the building. They may be vented from another room which in turn is vented to the outside in certain circumstances. A vent supplying air to an open-flue appliance shall not draw from a room or internal space containing a bath or shower.

Any installation should be installed so that it receives sufficient air for the proper combustion of the fuel and is capable of normal operation without the combustion products becoming a health hazard.

VENT COLOURS

*Not all colours are available for all vents
Subject to MOQ

Plastic vents *



Metal vents *

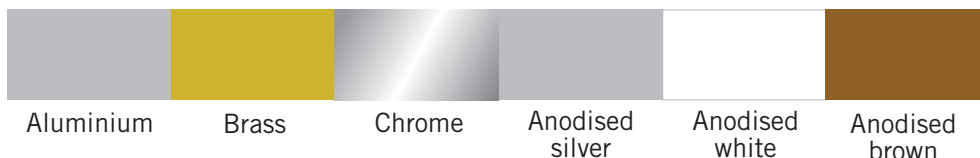

'BLACK HOLE' VENTILATION

'Black Hole' ventilation products provide the answer to the dangerous practice of ventilators being blocked off by occupiers who are trying to stop draughts. This is an important risk to safety. While this works to reduce draughts, the ventilator may not pass the required amount of air when the appliance is operating. It is important that a spillage test is carried out as specified by the British Standard and Corgi good practice.

'BLACK HOLE' BENEFITS

Stops wind blasting in

The air flow within the duct is slowed down by the change of direction and by the vortices formed, reducing draughts to a minimum.

Stops light showing through

The occupier cannot see through the ventilator.

Stops light shining out

Night flying insects like moths, crane flies and mosquitoes are not attracted in.

Absorbs outside noise

Reduces the penetration of traffic noise. The internal construction works as a sound baffle.

Practical

Allows air to be pulled through by the appliance when it is operating.

Safe

With draught and light annoyance problems eliminated, the occupier will not be tempted to block off the vent.

THE 'BLACK HOLE' MAGIC EXPLAINED

As outside wind pressure increases, a normal ventilator lets a lot of air through, causing draughts.

Inside the Stadium 'Black Hole' ventilator, vortices are formed behind the internal blades as the incoming air is forced to change direction. The gap that the air is able to pass through narrows. As wind pressure increases, the vortices grow. The total air flow is reduced and it finally tumbles and slows to a trickle, which cuts down annoying draughts.

However, when a heating appliance is operating, air is drawn through the vent and actually speeds up within the constricted air flow between the vortices. This maintains the correct amount of air in the room or compartment to allow the fuel to burn efficiently and flue gases to escape.

When the appliance is not working, incoming air is reduced to a minimum, even when wind levels are high. The actual physical difference is that of the air blown or drawn. The energy of the blown air (wind) is quickly dissipated by the restriction of the internal shape and the vortices, while drawn air will flow smoothly round the vortices.

TURBULENT



LAMINAR



BLACK HOLE VENTILATION KITS

If a longer tube length is required, extension tube BM810 can be purchased.

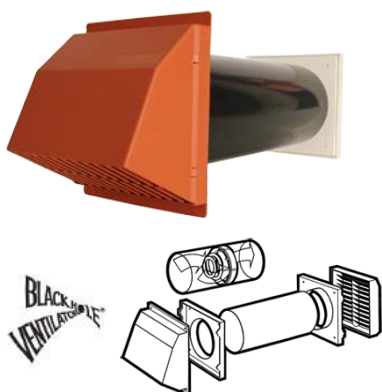

Core Drill 'Black Hole' Vario Ventilator

Flush fitting internal grille.

Product Code	Pack Size	Dimensions (mm)	Free Area (cm ²)	Rated Input (kW max.)	Colour/Finish
BM418/B	1	Cowl: 180 x 155 Grille: 155 x 155 Tube: 127 dia. 350 length	70 with baffle 100 without	21 with baffle 27 without	<ul style="list-style-type: none"> Brown cowl White internal
BM418/W	1	As above	70 with baffle 100 without	21 with baffle 27 without	<ul style="list-style-type: none"> White cowl White internal
BM418/T	1	As above	70 with baffle 100 without	21 with baffle 27 without	<ul style="list-style-type: none"> Terracotta cowl White internal

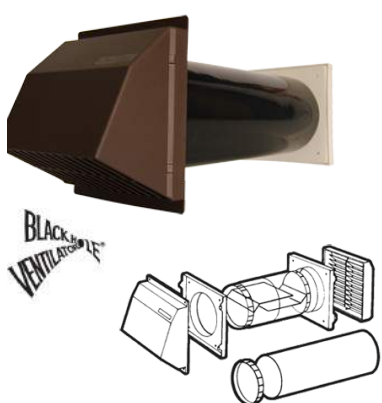

Core Drill 'Black Hole' Ventilator & Extension

Fixed anti-draught baffle.

Product Code	Pack Size	Dimensions (mm)	Free Area (cm ²)	Rated Input (kW max.)	Colour/Finish
BM725/B	1	Cowl: 180 x 155 Grille: 155 x 155 Tube: 127 dia. 228 length 585 extension	30	13	<ul style="list-style-type: none"> Brown cowl White internal
BM725/W	1	As above	30	13	<ul style="list-style-type: none"> White cowl White internal
BM725/T	1	As above	30	13	<ul style="list-style-type: none"> Terracotta cowl White internal

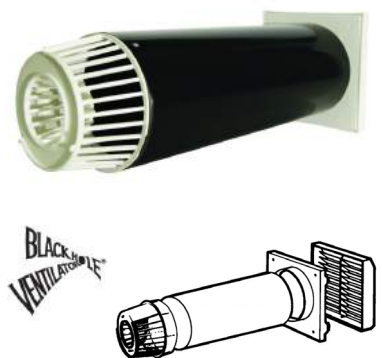

Core Drill 'Black Hole' Vario Ventilator for High Rise Buildings

Anti-draught baffle.

Product Code	Pack Size	Dimensions (mm)	Free Area (cm ²)	Rated Input (kW max.)	Colour/Finish
BM418/HR/B	1	Cowl: 127 dia. Grille: 155 x 155 Tube: 127 dia. 350 length	70 with baffle 100 without	21 with baffle 27 without	<ul style="list-style-type: none"> Brown external White internal
BM418/HR/W	1	As above	70 with baffle 100 without	21 with baffle 27 without	<ul style="list-style-type: none"> White external White internal



Anti-Draught 'Black Hole' Vario Ventilator with Cowl

Double brick size.

Product Code	Pack Size	Dimensions (mm)	Free Area (cm ²)	Rated Input (kW max.)	Colour/Finish
BM700/R	1	Cowl: 288 x 210 Grille: 270 x 195 Liner: length expands from 230 - 375	100	27	<ul style="list-style-type: none"> Rustic red cowl White internal
BM700/S	1	As above	100	27	<ul style="list-style-type: none"> Sand cowl White internal
BM700/B	1	As above	100	27	<ul style="list-style-type: none"> Brown cowl White internal

Anti-Draught 'Black Hole' Vario Ventilator with Airbrick



BLACK HOLE
VENTILATOR

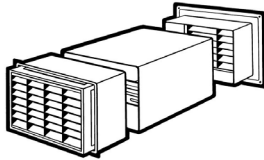

Double flush fit airbrick.

Product Code	Pack Size	Dimensions (mm)	Free Area (cm ²)	Rated Input (kW max.)	Colour/Finish
BM701/T	1	Airbrick: 216 x 152 Grille: 270 x 195 Liner: length expands from 230 - 375	100	27	■ Terracotta airbrick ■ White internal
BM701/R	1	As above	100	27	■ Rustic red airbrick ■ White internal
BM701/S	1	As above	100	27	■ Sand airbrick ■ White internal
BM701/B	1	As above	100	27	■ Brown airbrick ■ White internal

Anti-Draught 'Black Hole' Ventilator



BLACK HOLE
VENTILATOR

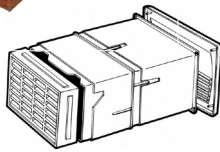

Expands to fit solid or cavity walls.
Invertible for high or low fitting.

Product Code	Pack Size	Dimensions (mm)	Free Area (cm ²)	Rated Input (kW max.)	Colour/Finish
BM720/T	1	Airbrick: 216 x 152 Grille: 290 x 200 Liner: length expands from 230 - 375	70	21	■ Terracotta airbrick ■ White internal
BM720/R	1	As above	70	21	■ Rustic red airbrick ■ White internal
BM720/S	1	As above	70	21	■ Sand airbrick ■ White internal

CORE DRILL KITS

If a longer tube length is required, extension tube BM810 or BM801 can be purchased.
Suitability of extension tube is dependent on tube diameter.

82mm (3¼") Core Drill Ventilator for High Rise Buildings



Complete with alternative external grille for use in high rise situations.

Product Code	Pack Size	Dimensions (mm)	Free Area (cm ²)	Rated Input (kW max.)	Colour/Finish
BM401/W	1	External grille: 100 dia. Internal grille: 100 dia. Tube: 82 dia. 350 length	34	13.8	■ White external ■ Brown internal

100mm (4") Core Drill Ventilator



Telescopic movement.
Louvred grille.

Product Code	Pack Size	Dimensions (mm)	Free Area (cm ²)	Rated Input (kW max.)	Colour/Finish
BM417/W	1	130 overall dia. Tube: 100 dia. Length expands from 100 - 195	35	14.2	■ White external ■ White internal

82mm (3¼") Core Drill Ventilator

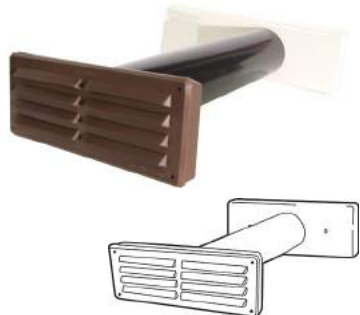

Product Code	Pack Size	Dimensions (mm)	Free Area (cm ²)	Rated Input (kW max.)	Colour/Finish
BM414/B	1	External grille: 241 x 89 Internal grille: 241 x 89 Tube: 82 dia. 350 length	Not suitable for gas appliances	Not suitable for gas appliances	<ul style="list-style-type: none"> ■ Brown external ■ White internal
BM414/W	1	As above	Not suitable for gas appliances	Not suitable for gas appliances	<ul style="list-style-type: none"> ■ White external ■ Brown internal

127mm (5") Core Drill Ventilator with Anti-Draught Cowl

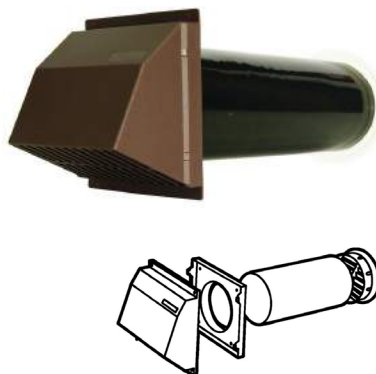

Flush fitting internal grille.

Product Code	Pack Size	Dimensions (mm)	Free Area (cm ²)	Rated Input (kW max.)	Colour/Finish
BM415/CA/B	1	Cowl: 180 x 155 Grille: 160 dia. Tube: 127 dia. 350 length	65	20	<ul style="list-style-type: none"> ■ Brown cowl ■ White internal
BM415/CA/W	1	As above	65	20	<ul style="list-style-type: none"> ■ White cowl ■ White internal

127mm (5") Core Drill Ventilator

Flush fitting internal grille.



Product Code	Pack Size	Dimensions (mm)	Free Area (cm ²)	Rated Input (kW max.)	Colour/Finish
BM415/B	1	External grille: 160 dia. Internal grille: 160 dia. Tube: 127 dia. 350 length	65	20	<ul style="list-style-type: none"> ■ Brown external ■ White internal
BM415/W	1	As above	65	20	<ul style="list-style-type: none"> ■ White external ■ White internal

127mm (5") Core Drill Ventilator



Product Code	Pack Size	Dimensions (mm)	Free Area (cm ²)	Rated Input (kW max.)	Colour/Finish
BM416	1	External grille: 260 x 184 Internal grille: 260 x 184 Tube: 127 dia. 610 length	100	27	<ul style="list-style-type: none"> ■ Brown external ■ Brass internal

152mm (6") Core Drill Ventilator

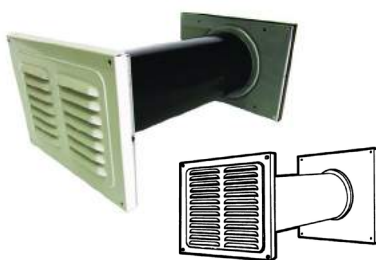

Product Code	Pack Size	Dimensions (mm)	Free Area (cm ²)	Rated Input (kW max.)	Colour/Finish
BM436	1	External grille: 265 x 265 Internal grille: 265 x 265 Tube: 152 dia. 610 length	161	39.2	<ul style="list-style-type: none"> ■ Brown external ■ White internal

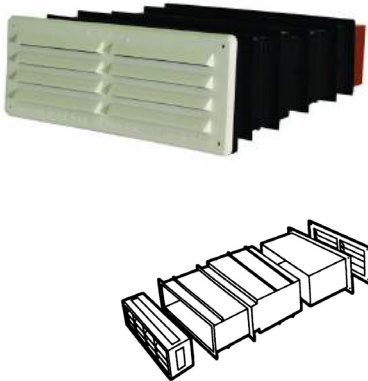
AIRBRICK KITS
Single Brick Set

Product Code	Pack Size	Dimensions (mm)	Free Area (cm ²)	Rated Input (kW max.)	Colour/Finish
BM430/BB	1	Airbrick: 216 x 76 Grille: 241 x 89 Liner: length expands from 250 - 343	40	15	<ul style="list-style-type: none"> ■ Blue/black external ■ White internal
BM430/T	1	As above	40	15	<ul style="list-style-type: none"> ■ Terracotta external ■ White internal
BM430/S	1	As above	40	15	<ul style="list-style-type: none"> ■ Sand external ■ White internal
BM430/B	1	As above	40	15	<ul style="list-style-type: none"> ■ Brown external ■ White internal

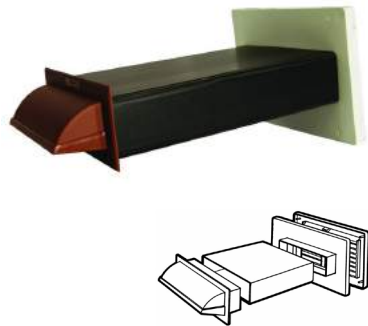
Single Brick Refurbishment Vent With Air Blast Cowl

May be cut to fit 216mm (9") solid walls.

Product Code	Pack Size	Dimensions (mm)	Free Area (cm ²)	Rated Input (kW max.)	Colour/Finish
BM432/R	1	Cowl: 216 x 76 Grille: 274 x 198 Liner: 350 length	100	27	<ul style="list-style-type: none"> ■ Rustic red cowl ■ White internal
BM432/B	1	As above	100	27	<ul style="list-style-type: none"> ■ Brown cowl ■ White internal

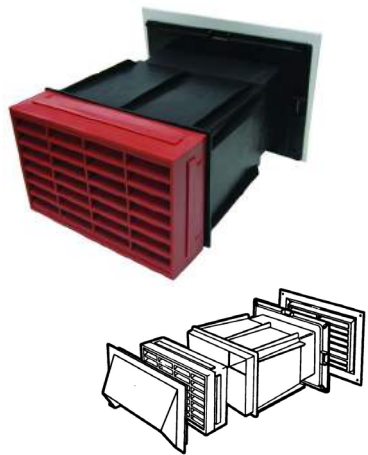
Double Brick Set with Airbrick

Product Code	Pack Size	Dimensions (mm)	Free Area (cm ²)	Rated Input (kW max.)	Colour/Finish
BM420T/T	1	Airbrick: 216 x 152 Grille: 273 x 197 Liner: length expands from 230 - 343	129	32.8	<ul style="list-style-type: none"> ☑ No cowl ■ Terracotta airbrick ■ White internal
BM420T/B	1	As above	129	32.8	<ul style="list-style-type: none"> ■ Brown cowl ■ Terracotta airbrick ■ White internal
BM420/1/T/T	1	As above	129	32.8	<ul style="list-style-type: none"> ■ Terracotta cowl ■ Terracotta airbrick ■ White internal

Double Brick Set with Cowl

Product Code	Pack Size	Dimensions (mm)	Free Area (cm ²)	Rated Input (kW max.)	Colour/Finish
BM444/B	5	Cowl: 260 x 160 Grille: 273 x 197 Liner: Length expands from 230 - 343	142	35	<ul style="list-style-type: none"> ■ Brown cowl ■ White internal
BM444/T	5	As above	142	35	<ul style="list-style-type: none"> ■ Terracotta cowl ■ White internal

TRICKLE VENTILATORS

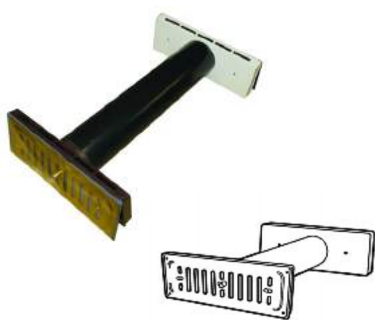

Trickle Background Ventilator

Hit & miss control on interior grille.

Product Code	Pack Size	Dimensions (mm)	Free Area (cm ²)	Rated Input (kW max.)	Colour/Finish
BM411/W	1	Exterior grille: 241 x 89 Interior grille: 241 x 89 Tube: 82 dia. 350 length	Not suitable for gas appliances	Not suitable for gas appliances	■ Brown external ■ White internal
BM411/BR	1	As above	Not suitable for gas appliances	Not suitable for gas appliances	■ Brown external ■ Brass internal

CAVITY LINERS & EXTENSION TUBES

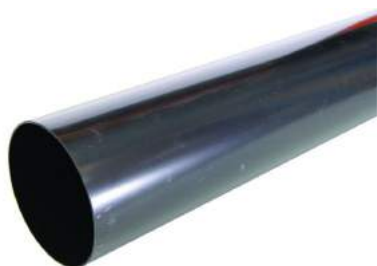

Rigid Long Extension Tube

Product Code	Pack Size	Dimensions (mm)	Free Area (cm ²)	Rated Input (kW max.)	Colour/Finish
BM810	1	127 dia. 1000 length	Determined by grille	Determined by grille	■ Black
BM801	1	152 dia. 610 length	Determined by grille	Determined by grille	■ Black



Extension Tube for use with BM417

Product Code	Pack Size	Dimensions (mm)	Free Area (cm ²)	Rated Input (kW max.)	Colour/Finish
BM811/W	1	100 dia. 350 length	Determined by grille	Determined by grille	■ White

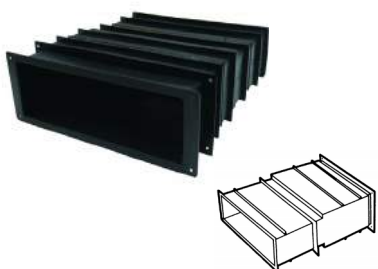

Single Brick Cavity Liner

Product Code	Pack Size	Dimensions (mm)	Free Area (cm ²)	Rated Input (kW max.)	Colour/Finish
BM433	10	216 x 76 220 length	Determined by grille	Determined by grille	■ Black



Double Brick Telescopic Cavity Liner

Product Code	Pack Size	Dimensions (mm)	Free Area (cm ²)	Rated Input (kW max.)	Colour/Finish
BM84	10	216 x 152 Length expands from 195 - 295	Determined by grille	Determined by grille	■ Black

HIT & MISS VENTILATORS
Hit & Miss Ventilator with Fly Screen

Product Code	Pack Size	Dimensions (mm)	Free Area (cm ²)	Rated Input (kW max.)	Colour/Finish
BM473	10	241 x 89	Not suitable for gas appliances	Not suitable for gas appliances	White
BM476	10	241 x 165	Not suitable for gas appliances	Not suitable for gas appliances	White
BM479	10	241 x 241	Not suitable for gas appliances	Not suitable for gas appliances	White

Brass Hit & Miss Ventilator

Product Code	Pack Size	Dimensions (mm)	Free Area (cm ²)	Rated Input (kW max.)	Colour/Finish
BM331	1	241 x 89	Not suitable for gas appliances	Not suitable for gas appliances	Brass, polished & lacquered
BM332	1	241 x 165	Not suitable for gas appliances	Not suitable for gas appliances	Brass, polished & lacquered
BM333	1	241 x 241	Not suitable for gas appliances	Not suitable for gas appliances	Brass, polished & lacquered

Aluminium Hit & Miss Ventilator

Product Code	Pack Size	Dimensions (mm)	Free Area (cm ²)	Rated Input (kW max.)	Colour/Finish
BM351	25	241 x 89	Not suitable for gas appliances	Not suitable for gas appliances	Aluminium
BM352	25	241 x 165	Not suitable for gas appliances	Not suitable for gas appliances	Aluminium
BM353	25	241 x 241	Not suitable for gas appliances	Not suitable for gas appliances	Aluminium

LOUVRE VENTILATORS
Internal Grille Assembly

Universal for circular and rectangular ducting.



Product Code	Pack Size	Dimensions (mm)	Free Area (cm ²)	Rated Input (kW max.)	Colour/Finish
BM421/W	5	155 x 155 127 dia. spigot	100	27	White

Louvre Ventilator

Product Code	Pack Size	Dimensions (mm)	Free Area (cm ²)	Rated Input (kW max.)	Colour/Finish
BM463	10	241 x 89	40	15	White
BM466	10	241 x 165	80	23	White
BM469	10	241 x 241	100	27	White

Louvre Ventilator with Fly Screen



Product Code	Pack Size	Dimensions (mm)	Free Area (cm ²)	Rated Input (kW max.)	Colour/Finish
BM463/F	10	241 x 89	Not suitable for gas appliances	Not suitable for gas appliances	White
BM466/F	10	241 x 165	Not suitable for gas appliances	Not suitable for gas appliances	White
BM469/F	10	241 x 241	Not suitable for gas appliances	Not suitable for gas appliances	White

Face-Fitting Fixed Louvre Grille with Large Flange



Fits onto BM84 Cavity Liner.
Can be plastered in.

Product Code	Pack Size	Dimensions (mm)	Free Area (cm ²)	Rated Input (kW max.)	Colour/Finish
BM72/1	10	274 x 198	142	35.4	White
BM72/2/F	10	274 x 198	Not suitable for gas appliances	Not suitable for gas appliances	White

Face-Fitting Fixed Louvred Grille with Large Flange & Tear Off Strips



Fits onto BM84 Cavity Liner.
Can be plastered in.

Product Code	Pack Size	Dimensions (mm)	Free Area (cm ²)	Rated Input (kW max.)	Colour/Finish
BM72/TO	10	274 x 198	142	35.4	White

Innovator Round Louvre Ventilator

For external and internal use.
Use without fly screen for gas appliance ventilation.



Product Code	Pack Size	Dimensions (mm)	Free Area (cm ²)	Rated Input (kW max.)	Colour/Finish
BM885/W	1	165 dia. To fit 100, 125, 150 and 165 dia.	115 for 125mm	30	White
BM885/B	1	165 dia. To fit 100, 125, 150 and 165 dia.	115 for 125mm	30	Brown
BM885/BK	1	165 dia. To fit 100, 125, 150 and 165 dia.	115 for 125mm	30	Black

Anodised Aluminium Louvre Ventilator



Product Code	Pack Size	Dimensions (mm)	Free Area (cm ²)	Rated Input (kW max.)	Colour/Finish
BM370	10	680 x 70	85	24	Aluminium
BM372	10	785 x 70	100	27	Aluminium



Metal Louvre Ventilator

To fit rigid or flexible tubes 127mm dia.

Product Code	Pack Size	Dimensions (mm)	Free Area (cm ²)	Rated Input (kW max.)	Colour/Finish
BM339/B	1	260 x 184	100	27	■ Brown
BM339	1	260 x 184	100	27	■ Brass



Aluminium Louvre Ventilator

Product Code	Pack Size	Dimensions (mm)	Free Area (cm ²)	Rated Input (kW max.)	Colour/Finish
BM361	25	241 x 89	29	12.8	■ Aluminium
BM362	25	241 x 165	59	18.8	■ Aluminium
BM363	25	241 x 241	88	24.6	■ Aluminium
BM364	10	305 x 241	180	43	■ Aluminium
BM365	10	305 x 305	257	58.4	■ Aluminium



Anodised Aluminium Louvre Ventilator

Product Code	Pack Size	Dimensions (mm)	Free Area (cm ²)	Rated Input (kW max.)	Colour/Finish
BM361/S	10	241 x 89	29	12.8	■ Anodised silver
BM362/S	10	241 x 165	59	18.8	■ Anodised silver
BM363/S	10	241 x 241	88	24.6	■ Anodised silver

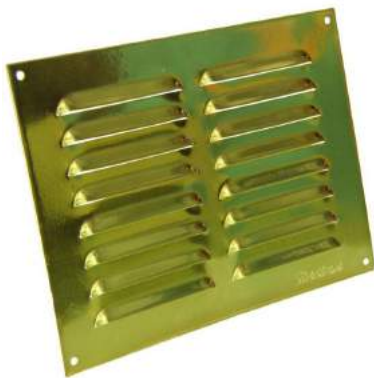

Brass Louvre Ventilator

Product Code	Pack Size	Dimensions (mm)	Free Area (cm ²)	Rated Input (kW max.)	Colour/Finish
BM341	1	241 x 89	29	12.8	■ Brass, polished & lacquered
BM342	1	241 x 165	59	18.8	■ Brass, polished & lacquered
BM343	1	241 x 241	88	24.6	■ Brass, polished & lacquered
BM344	1	305 x 241	180	43	■ Brass, polished & lacquered
BM346	5	610 x 76	51	17	■ Brass, polished & lacquered



Gravity Flap Terminal Vent

Product Code	Pack Size	Dimensions (mm)	Free Area (cm ²)	Rated Input (kW max.)	Colour/Finish
BM449/B	1	155 x 155 100 dia. spigot	Not suitable for gas appliances	Not suitable for gas appliances	■ Brown
BM449/W	1	As above	Not suitable for gas appliances	Not suitable for gas appliances	■ White
BM449/B	1	As above	Not suitable for gas appliances	Not suitable for gas appliances	■ Black

Louvred Terminal Vent

Universal for circular &w rectangular ducting.



Product Code	Pack Size	Dimensions (mm)	Free Area (cm ²)	Rated Input (kW max.)	Colour/Finish
BM450/B	1	155 x 155 100 dia. spigot	38	14.6	■ Brown
BM450/W	1	155 x 155 100 dia. spigot	38	14.6	■ White
BM450/BK	1	155 x 155 100 dia. spigot	38	14.6	■ Black
BM450/F/B (with fly screen)	1	155 x 155 100 dia. spigot	Not suitable for gas appliances	Not suitable for gas appliances	■ Brown
BM450/F/W (with fly screen)	1	155 x 155 100 dia.spigot	Not suitable for gas appliances	Not suitable for gas appliances	■ White
BM450/F/BK (with fly screen)	1	155 x 155 100 dia.spigot	Not suitable for gas appliances	Not suitable for gas appliances	■ Black

FACE FITTING VENTILATORS

Face Fitting Ventilator



Product Code	Pack Size	Dimensions (mm)	Free Area (cm ²)	Rated Input (kW max.)	Colour/Finish
BM461/W	10	298 x 290	270	61	■ White powder coat

Face Fitting Fixed Louvred Grille



Product Code	Pack Size	Dimensions (mm)	Free Area (cm ²)	Rated Input (kW max.)	Colour/Finish
BM73	25	274 x 198	100	27	■ White

Compartment / Exterior Face Fitting Ventilator



Product Code	Pack Size	Dimensions (mm)	Free Area (cm ²)	Rated Input (kW max.)	Colour/Finish
BM367	1	410 x 240	316	70.2	■ Aluminium
BM367/W	1	410 x 240	316	70.2	■ White powder coat
BM368	1	410 x 330	445	96	■ Aluminium
BM368/W	1	410 x 330	445	96	■ White powder coat
BM369	1	410 x 500	693	145.6	■ Aluminium
BM369/W	1	410 x 500	693	145.6	■ White powder coat

FLUSH FITTING VENTILATORS

For BM460/B, BM460/W & BM462/W 1 pack contains 1 pair of vents.

Flush Fitting Ventilator

Product Code	Pack Size	Dimensions (mm)	Free Area (cm ²)	Rated Input (kW max.)	Colour/Finish
BM460/B	1 pair	370 x 130	144	35.8	■ Brown
BM460/W	1 pair	370 x 130	144	35.8	■ White

Flush Fitting Ventilator

Product Code	Pack Size	Dimensions (mm)	Free Area (cm ²)	Rated Input (kW max.)	Colour/Finish
BM462/W	1 pair	370 x 231	306	68.2	■ White

EXTERNAL COWLS

Large Cowl

Fits over double brick ventilator.

Product Code	Pack Size	Dimensions (mm)	Free Area (cm ²)	Rated Input (kW max.)	Colour/Finish
BM447/R	5	225 x 150	142	35.4	■ Rustic red
BM447/S	5	225 x 150	142	35.4	■ Sand
B447/B	5	225 x 150	142	35.4	■ Brown

Large Cowl with Grille in Base

Fits over three air bricks.

Product Code	Pack Size	Dimensions (mm)	Free Area (cm ²)	Rated Input (kW max.)	Colour/Finish
BM424/B	1	300 x 300	193	45.6	■ Brown
BM424/W	1	300 x 300	193	45.6	■ White

Outer Cowl

 As used in the BM418/HR.
Can be installed from inside the building.

Product Code	Pack Size	Dimensions (mm)	Free Area (cm ²)	Rated Input (kW max.)	Colour/Finish
BM419/HR/B	5	127 dia. spigot	100	27	■ Brown
BM419/HR/W	5	127 dia. spigot	100	27	■ White



Standard Double Brick Cowl

Fits over airbricks up to 230 x 150mm.
Fits over other ventilators when lip is removed.

Product Code	Pack Size	Dimensions (mm)	Free Area (cm ²)	Rated Input (kW max.)	Colour/Finish
BM422/B	5	260 x 160	100	27	■ Brown
BM422/T	5	260 x 160	100	27	■ Terracotta



Cross-Over Cowl

Will fit over airbricks up to 230 x 150mm.
Will fit over BM415, BM416 and BM417 ventilators.

Product Code	Pack Size	Dimensions (mm)	Free Area (cm ²)	Rated Input (kW max.)	Colour/Finish
BM429/B	5	300 x 230 x 40 Only protrudes 40mm from wall	132	33.4	■ Brown powder coated aluminium



Single Brick Cowl

Fits single air brick size 216 x 76mm.
Fits rectangular duct.

Product Code	Pack Size	Dimensions (mm)	Free Area (cm ²)	Rated Input (kW max.)	Colour/Finish
BM432/C/R	1	216 x 76	100	27	■ Rustic red
BM432/C/B	1	216 x 76	100	27	■ Brown



External Cowl Assembly

Product Code	Pack Size	Dimensions (mm)	Free Area (cm ²)	Rated Input (kW max.)	Colour/Finish
BM419/B	5	180 x 155 127 dia. spigot	100	27	■ Brown
BM419/W	5	180 x 155 127 dia. spigot	100	27	■ White
BM419/T	5	180 x 155 127 dia. spigot	100	27	■ Terracotta



Cowl Terminal Vent

Universal for circular and rectangular ducting.
With backdraught flap.

Product Code	Pack Size	Dimensions (mm)	Free Area (cm ²)	Rated Input (kW max.)	Colour/Finish
BM457/B	1	155 x 155 100 dia. spigot	Not suitable for gas appliances	Not suitable for gas appliances	■ Brown
BM457/W	1	155 x 155 100 dia. spigot	Not suitable for gas appliances	Not suitable for gas appliances	■ White
BM457/BK	1	155 x 155 100 dia. spigot	Not suitable for gas appliances	Not suitable for gas appliances	■ Black

AIR BRICKS
Multi-Fit Brick

Product Code	Pack Size	Dimensions (mm)	Free Area (cm ²)	Rated Input (kW max.)	Colour/Finish
BM481/T	50	216 x 76	72	21.4	■ Terracotta

Louvre Airbrick - Single

Fits into BM433 liner.
Fits both metric and imperial brickwork.
Lightweight but tough, ribbed for mortar key, rough cast finish.



Product Code	Pack Size	Dimensions (mm)	Free Area (cm ²)	Rated Input (kW max.)	Colour/Finish
BM483/BB	10	216 x 76	46	16.2	■ Blue/black
BM483/T	10	216 x 76	46	16.2	■ Terracotta
BM483/S	10	216 x 76	46	16.2	■ Sand
BM483/B	10	216 x 76	46	16.2	■ Brown

Louvre Airbrick - Double

Fits into BM84 liner.
Fits both metric and imperial brickwork.
Lightweight but tough, ribbed for mortar key, rough cast finish.



Product Code	Pack Size	Dimensions (mm)	Free Area (cm ²)	Rated Input (kW max.)	Colour/Finish
BM486/BB	10	216 x 152	125	32	■ Blue/black
BM486/T	10	216 x 152	125	32	■ Terracotta
BM486/R	10	216 x 152	125	32	■ Rustic red
BM486/S	10	216 x 152	125	32	■ Sand
BM486/B	10	216 x 152	125	32	■ Brown

Square Hole Airbrick

Fits both metric and imperial brickwork.
Lightweight but tough, ribbed for mortar key, rough cast finish.



Product Code	Pack Size	Dimensions (mm)	Free Area (cm ²)	Rated Input (kW max.)	Colour/Finish
BM487/B	10	216 x 152	66	20.2	■ Brown

Weep Ventilator

Internal insect and water barrier.



Product Code	Pack Size	Dimensions (mm)	Free Area (cm ²)	Rated Input (kW max.)	Colour/Finish
BM413/G	25	104 x 65 x 10	Not applicable	Not applicable	■ Grey
BM413/S	25	104 x 65 x 10	Not applicable	Not applicable	■ Sand
BM413/T	25	104 x 65 x 10	Not applicable	Not applicable	■ Terracotta
BM413/B	25	104 x 65 x 10	Not applicable	Not applicable	■ Brown

THROUGH FLOOR VENTILATORS

Lacquered Brass Through Floor Ventilator



Product Code	Pack Size	Dimensions (mm)	Free Area (cm ²)	Rated Input (kW max.)	Colour/Finish
BM435	1	280 x 108 Hole size 213 x 76	100	27	■ Brass ■ Black duct box
BM435/C	1	280 x 108 Hole size 213 x 76	100	27	■ Chrome ■ Black duct box

MINI VENTILATORS

Mini Round Ventilator



Product Code	Pack Size	Dimensions (mm)	Free Area (cm ²)	Rated Input (kW max.)	Colour/Finish
BM409/W	100	40 dia. Fits 28mm hole	2	7.4	■ White

SOFFIT VENTILATORS

Soffit Ventilator

Centres for roof pitches over 15 degrees.

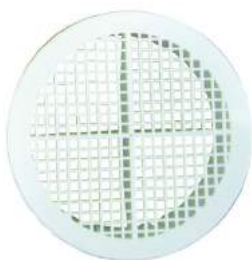

Product Code	Carton Qty	Dimensions (mm)	Free Area (cm ²)	Rated Input (kW max.)	Colour/Finish
BM406/B	20	88 outer dia. 76 spigot	25	12	■ Brown
BM406/W	20	88 outer dia. 76 spigot	25	12	■ White

Soffit Ventilator

Centres for roof pitches over 15 degrees.
Overlapping double 76mm (3") holes.



Product Code	Carton Qty	Dimensions (mm)	Free Area (cm ²)	Rated Input (kW max.)	Colour/Finish
BM407/B	20	145 x 85 76 spigot x 2	45.6	16.1	■ Brown
BM407/W	20	145 x 85 76 spigot x 2	45.6	16.1	■ White

EXTRACTOR FANS

Extractor Fan

Product Code	Pack Size	Dimensions (mm)	Extraction Rate (cm ³ /hour)	Rated Input (liters/second)	Colour/Finish
BME100S	1 - standard	100 dia.	85	23	■ White
BME100P	1 - with pull cord	100 dia.	85	23	■ White
BME100H	1 - with humidistat	100 dia.	85	23	■ White
BME100T	1 - with timer	100 dia.	85	23	■ White

DUCTING

Tumble Dryer Universal Ducting Kit

For through wall clearance use 107mm core drill.

Product Code	Pack Size	Dimensions (mm)	Colour/Finish
BM830	1 set Consists of: - Terminal flap vent - Back plate - Flexible ducting - Screw pack	Ducting: 100 dia. 100 - 1200 length	■ White components

Tumble Dryer Universal Ducting Kit

Adaptable for through wall or window.

Product Code	Pack Size	Dimensions (mm)	Colour/Finish
BM832	1 set Consists of: - Circular baffled vent - Rigid through wall tube - Wall plate/window adaptor ring with rubber seal - Flexible ducting with spigot - Wall plugs & screws	Ducting: 100 dia. 100 length Rigid tube: 115 dia. 350 long	■ White plastic vent & ducting ■ Black rigid tube

Cooker Hood Universal Ducting Kit

Baffled wall vent.

Product Code	Pack Size	Dimensions (mm)	Colour/Finish
BM841	1 set Consists of: - Baffled wall vent - 2 flat channels - 1 connector - 1 wall plate - 190 flat bend - Flexible flame retardant duct - Round connectors (x2) - Round to rectangular adaptor - Screw pack	Ducting: 100 dia. 1000 length Channels: 1000 length	■ White components

Flexible Ducting

PVC sheathed wirecoil.
Self extinguishing & flame retardant.
For tumble dryers & extractor fans.
Suitable for loft spaces / above unit installations.



Product Code	Pack Size	Dimensions (mm)	Colour/Finish
BM809	1	125 dia. 3000 length	White
BM991	1	100 dia. 1000 length	White
BM992	1	100 dia. 2000 length	White
BM993	1	100 dia. 3000 length	White
BM813	1	100 dia. 15000 length	White
BM814	1	100 dia. 45000 length	White

Rigid Long Extension Tube

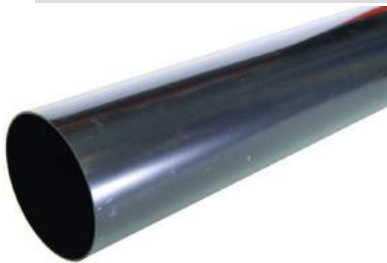

Product Code	Pack Size	Dimensions (mm)	Colour/Finish
BM810	1	125 dia. 1000 length	Black
BM801	1	152 dia. 610 length	Black

Rigid Tube

Extension tube fits Terminal Grilles BM450 & BM449.



Product Code	Pack Size	Dimensions (mm)	Colour/Finish
BM811/W	1	100 dia. 350 length	White

Deep Flat Ducting



Product Code	Pack Size	Dimensions (mm)	Colour/Finish
BM972/W	1	100 x 55 1500 length	White

Rectangular / Round Adaptor



Product Code	Pack Size	Dimensions (mm)	Colour/Finish
BM973/W	1	100 x 55 100 dia. spigot	White

Horizontal 90 Degree Bend



Product Code
BM974/W

Pack Size
1

Dimensions (mm)
100 x 55

Colour/Finish
■ White

Flat / Rectangular Connector



Product Code
BM976/W

Pack Size
1

Dimensions (mm)
100 x 55

Colour/Finish
■ White

Vertical 90 Degree Bend



Product Code
BM978/W

Pack Size
1

Dimensions (mm)
100 x 55

Colour/Finish
■ White

Hose Connector Bend



Product Code
BM979/W

Pack Size
1

Dimensions (mm)
100 x 55
100 dia. spigot

Colour/Finish
■ White

RHINO FLEXI TUBS, BUCKETS & BINS



FLEXI TUB STAND PACK

The original, the best & made in the UK. 1,000s of uses!



FREE STAND INCLUDED

Includes:

- 20 x 12L Flexi Tub
- 20 x 26L Flexi Tub
- 20 x 40L Flexi Tub
- 20 x 75L Flexi Tub
- 20 x 14L BB6 Builders' Buckets
- 1 x Display Stand

Code = BM1/Y









RHINO FLEXI TUBS, BUCKETS & BINS

- Strongest tub on the market - BBA tested to 360kg
- Rib structure for optimal strength and performance
- Ergonomically designed handles
- Made from flexible LDPE - great for fitting into tight spaces
- Non toxic
- Frost resistant

Flexi Tub

	Product Code	Pack Size	Capacity (litres)	Height (mm)	Base dia. (mm)	Lip dia. (mm)	Colour/ Finish
	BM5/12	10	12	190	290	350	Black
	BM5/12/G	10	12	190	290	350	Dark green
	BM5/12/LB	10	12	190	290	350	Light blue
	BM5/12/PK	10	12	190	290	350	Pink
	BM5/12/P	10	12	190	290	350	Purple
	BM5/12/R	10	12	190	290	350	Red
	BM5/12/Y	10	12	190	290	350	Yellow
	BM5/26	10	26	320	290	390	Black
	BM5/26/G	10	26	320	290	390	Dark green
	BM5/26/LB	10	26	320	290	390	Light blue
	BM5/26/PK	10	26	320	290	390	Pink
	BM5/26/P	10	26	320	290	390	Purple
	BM5/26/R	10	26	320	290	390	Red
	BM5/26/Y	10	26	320	290	390	Yellow
	BM5/40	10	40	350	360	460	Black
	BM5/40/G	10	40	350	360	460	Dark green
	BM5/40/LB	10	40	350	360	460	Light blue
	BM5/40/PK	10	40	350	360	460	Pink
	BM5/40/P	10	40	350	360	460	Purple
	BM5/40/R	10	40	350	360	460	Red
	BM5/40/Y	10	40	350	360	460	Yellow
	BM5/75	5	75	380	460	580	Black
	BM5/75/G	5	75	380	460	580	Dark green
	BM5/75/LB	5	75	380	460	580	Light blue
	BM5/75/R	5	75	380	460	580	Red
	BM5/75/Y	5	75	380	460	580	Yellow

Other colours available upon request, subject to MOQ.

RHINO FLEXI TUBS, BUCKETS & BINS



Everyday Bucket

Light duty bucket.

Product Code	Pack Size	Capacity (litres)	Height (mm)	Base dia. (mm)	Lip dia. (mm)	Colour/Finish
BB2	10	14	260	240	350	■ Black



General Trade Bucket

Medium duty bucket.

Product Code	Pack Size	Capacity (litres)	Height (mm)	Base dia. (mm)	Lip dia. (mm)	Colour/Finish
BB3/G	10	14	265	235	330	■ Green
BB3/LB	10	14	265	235	330	■ Light blue
BB3/PK	10	14	265	235	330	■ Pink
BB3/P	10	14	265	235	330	■ Purple
BB3/R	10	14	265	235	330	■ Red
BB3/Y	10	14	265	235	330	■ Yellow



Pour & Scoop Bucket

Wide flat back for easy scooping.
Slope feature for accurate pouring.
Finger recess for improved handling.

Product Code	Pack Size	Capacity (litres)	Height (mm)	Base dia. (mm)	Lip dia. (mm)	Colour/Finish
BB4	10	14	259	259	355	■ Black



Professional Bucket

Heavy duty bucket.

Product Code	Pack Size	Capacity (litres)	Height (mm)	Base dia. (mm)	Lip dia. (mm)	Colour/Finish
BB5	10	14	280	240	340	■ Grey



Industrial Bucket

Heavy duty bucket.
Made from strong, easy-clean, impact-modified material.

Product Code	Pack Size	Capacity (litres)	Height (mm)	Base dia. (mm)	Lip dia. (mm)	Colour/Finish
BB6	10	14	290	225	340	■ Yellow



5L Flexible Bucket

Made from flexible LDPE.
Non-stick and easy to clean.
Can be used as a calf bucket.

Product Code	Pack Size	Capacity (litres)	Height (mm)	Base dia. (mm)	Lip dia. (mm)	Colour/Finish
BM7/B	10	5	215	185	240	■ Blue
BM7/G	10	5	215	185	240	■ Dark green
BM7/R	10	5	215	185	240	■ Red



RHINO FLEXI TUBS, BUCKETS & BINS

Shallow Bucket

Can be used as a mixing & feed bucket.



Product Code	Pack Size	Capacity (litres)	Height (mm)	Base dia. (mm)	Lip dia. (mm)	Colour/ Finish
BM8	10	15	190	300	395	Black
BM8/G	10	15	190	300	395	Green
BM8/LB	10	15	190	300	395	Light blue
BM8/PK	10	15	190	300	395	Pink
BM8/P	10	15	190	300	395	Purple
BM8/R	10	15	190	300	395	Red
BM8/Y	10	15	190	300	395	Yellow

Premium 10L Bucket



Product Code	Pack Size	Capacity (litres)	Height (mm)	Base dia. (mm)	Lip dia. (mm)	Colour/ Finish
BM10/B	10	9.3	260	210	255	Black
BM10/G	10	9.3	260	210	255	Dark green

Galvanised Bucket

Heavy duty bucket.



Product Code	Pack Size	Capacity (litres)	Height (mm)	Base dia. (mm)	Lip dia. (mm)	Colour/ Finish
GB07	1	7	230	250	170	Galvanised
GB13	1	13	265	230	315	Galvanised

Tuff Tub

With two rope handles.
Ideal for the transportation of equipment & waste materials.



Product Code	Pack Size	Capacity (litres)	Height (mm)	Base dia. (mm)	Lip dia. (mm)	Colour/ Finish
TT69L	6	69	425	440	545	Black

Heavy Duty Dustbin

UV stabilised.
Conforms to BS4998.



Product Code	Pack Size	Capacity (litres)	Height (mm)	Dia. (mm)	Total Width (mm)	Colour/ Finish
BM199	1	90	700	500	650	Black
BM199/BL	1	90	700	500	650	Blue
BM199/G	1	90	700	500	650	Green
BM199/P	1	90	700	500	650	Purple
BM199/R	1	90	700	500	650	Red
BM199/Y	1	90	700	500	650	Yellow

RHINO GARDENING RANGE



Rhino Water Butt 100L & 200L



Product Code	Pack Size	Dimensions (mm)	Colour/Finish
WB100/KIT	1 x 100L kit Consists of 100L drum, base, lid, tap & diverter	W489, D489, H1125	■ Green & black
WB200/KIT	1 x 200L kit Consists of 200L drum, base, lid, tap & diverter	W595, D595, H1295	■ Green & black

Rhino Easi Can 10L



Product Code	Pack Size	Dimensions (mm)	Colour/Finish
WC10	5	W600	■ Black
WC10/G	5	D150	■ Green
WC10/R	5	H350	■ Red

Standard Garden Hose

5 year guarantee.



Product Code	Pack Size	Dimensions (m)	Colour/Finish
BM116	1	15	■ Green
BM117	1	30	■ Green

Snap-On Tap Connector



Product Code	Pack Size	Dimensions (mm)	Colour/Finish
602SNCP	10	To fit most kitchen taps	■ Green
607SNCP	10	To fit all outside taps 19 (¾") & 13 (½") connector	■ Green

Hose Fittings & Adaptors



Product Code	Pack Size	Dimensions (mm)	Colour/Finish
605SNCP	10	To fit 13 (½") hose	■ Green

Flambeau Zerust® stops rust and corrosion by creating a vapour shield around valuable items stored in your toolbox or Tuff Tainer®. Moulded into the polymer, Zerust® is odourless, non-toxic, maintenance free and remains active for up to 5 years.



Toolbox with Zerust®

Product Code	Pack Size	Dimensions (mm)	Colour/Finish
TB19IN	4	L490, W230, H230	<input checked="" type="checkbox"/> Black lid <input checked="" type="checkbox"/> Black body
TB22IN	2	L550, W310, H255	<input checked="" type="checkbox"/> Black lid <input checked="" type="checkbox"/> Black body
TB26IN	2	L655, W310, H266	<input checked="" type="checkbox"/> Black lid <input checked="" type="checkbox"/> Black body







Funnel

Product Code	Pack Size	Dimensions (mm)	Colour/Finish
BM214	10	100	<input type="checkbox"/> Clear
BM216	10	150	<input type="checkbox"/> Clear
BM218	10	200	<input type="checkbox"/> Clear



Luggage Elastics

Product Code	Pack Size	Dimensions (mm)	Colour/Finish
BM164	10	457	 Multi (blue, green, red)
BM168	10	610	 Multi (blue, green, red)
BM170	10	762	 Multi (blue, green, red)
BM172	10	914	 Multi (blue, green, red)



'Sealtite' Roofing Washers

UV stable.

Product Code	Pack Size	Dimensions (mm)	Colour/Finish
BM20/1	100	6.5	<input checked="" type="checkbox"/> Black polythene
BM20/2	100	8	<input checked="" type="checkbox"/> Black polythene



'Sealtite' Roofing Washers

UV stable.
Internal boss minimises splitting when tightened.

Product Code	Pack Size	Dimensions (mm)	Colour/Finish
BM70/1	100	6.5	<input checked="" type="checkbox"/> Black polythene
BM70/2	100	8	<input checked="" type="checkbox"/> Black polythene



Plumbing Mat

Patent No. 2129368

Product Code BM201	Pack Size 1	Dimensions (mm) 305 x 250 (12 x 10")	Colour/Finish ■ Black
------------------------------	-----------------------	--	---------------------------------



Tuff Tainer® 3003



3 partitions with 9 Zerust® dividers.
Integrated latches.

Product Code 3003	Pack Size 12	Dimensions (mm) L241, W178, H32	Colour/Finish <input type="checkbox"/> Clear container (blue dividers)
-----------------------------	------------------------	---	---



Tuff Tainer® 3009



3 partitions with 9 Zerust® dividers.

Product Code 3009	Pack Size 6	Dimensions (mm) L305, W114, H38	Colour/Finish <input type="checkbox"/> Clear container (blue dividers & latches)
-----------------------------	-----------------------	---	---



Tuff Tainer® 4004



4 partitions with 9 Zerust® dividers.

Product Code 4004	Pack Size 6	Dimensions (mm) L279, W184, H44	Colour/Finish <input type="checkbox"/> Clear container (blue dividers & latches)
-----------------------------	-----------------------	---	---



Tuff Tainer® 4006



6 partitions with 10 Zerust® dividers.
Integrated latches.

Product Code 4006	Pack Size 6	Dimensions (mm) L279, W184, H44	Colour/Finish <input type="checkbox"/> Clear container (blue dividers)
-----------------------------	-----------------------	---	---



Tuff Tainer® 4007



6 partitions with 10 Zerust® dividers.
High value removable latches.

Product Code 4007	Pack Size 6	Dimensions (mm) L279, W184, H44	Colour/Finish <input type="checkbox"/> Clear container (blue dividers & latches)
-----------------------------	-----------------------	---	---



Tuff Tainer® 5003

3 partitions with 12 Zerust® dividers.
High value removable latches.

Product Code 5003	Pack Size 6	Dimensions (mm) L362, W232, H50	Colour/Finish <input type="checkbox"/> Clear container (blue dividers & latches)
-----------------------------	-----------------------	---	---



Tuff Tainer® 5004

4 partitions with 15 Zerust® dividers.
Integrated latches.

Product Code 5004	Pack Size 6	Dimensions (mm) L362, W232, H50	Colour/Finish <input type="checkbox"/> Clear container (blue dividers)
-----------------------------	-----------------------	---	---



Tuff Tainer® 5007

4 partitions with 15 Zerust® dividers.
High value removable latches.

Product Code 5007	Pack Size 6	Dimensions (mm) L362, W232, H50	Colour/Finish <input type="checkbox"/> Clear container (blue dividers & latches)
-----------------------------	-----------------------	---	---



Mixing Tray

Product Code	Pack Size	Capacity (litres)	Dimensions (mm)	Colour/Finish
BM194	1		900 dia.	■ Black



Plasterers' Mixing Bucket

Product Code	Pack Size	Capacity (litres)	Dimensions (mm)	Colour/Finish
BM195	1	30	H470 Base dia. 260 Lip dia. 340	■ Natural



Compact Plasterers' Mixing Bath

Product Code	Pack Size	Capacity (litres)	Dimensions (mm)	Colour/Finish
BM196	1	125	L930, W650, H340	■ Natural



Plasterers' Bath

Product Code	Pack Size	Capacity (litres)	Dimensions (mm)	Colour/Finish
BM197	1	165	L1230, W620, H330	■ Natural



Plasterers' Hawk

Product Code	Pack Size	Capacity (litres)	Dimensions (mm)	Colour/Finish
BM82/1	5		330 x 330	■ Natural foam



Plasterers' Float

Product Code	Pack Size	Capacity (litres)	Dimensions (mm)	Colour/Finish
BM83/1/1	10		365 x 152	■ Natural foam
BM83/2/1	10		297 x 108	■ Natural foam



Sponge Faced Plasterers' Float

Product Code	Pack Size		Dimensions (mm)	Colour/Finish
BM83/SF	10		385 x 115	<input type="checkbox"/> Natural foam



Paint Kettle

Product Code	Pack Size	Capacity (litres)	Dimensions (mm)	Colour/Finish
PK1L	20	1	H110 Dia. 145	<input type="checkbox"/> White
PK2L	20	2.5	H138 Dia. 195	<input type="checkbox"/> White
PK5L	20	5	H190 Dia. 225	<input type="checkbox"/> White

Nail-On Pipe Clips



Product Code	Pack Size	Dimensions (mm)	Colour/Finish
BM13/1	100	7-10	White
BM13/2	100	10-14	White
BM13/3	100	15	White
BM13/4	100	22	White

Snap-On Pipe Clips



Single centre screw fitting.

Product Code	Pack Size	Dimensions (mm)	Colour/Finish
BM33/1	100	15	White
BM33/2	100	22	White
BM33/3	100	28	White
BM33/4	50	15	White
BM33/6	50	22	White

Hinged Pipe Clips

Single centre screw fitting.
Clips in place with finger pressure.



Product Code	Pack Size	Dimensions (mm)	Colour/Finish
BM71/1	100	15	White
BM71/2	100	22	White
BM71/3	50	28	White
BM71/4	100	15	White
BM71/6	100	22	White

Cistern Float



Product Code	Pack Size	Dimensions (mm)	Colour/Finish
BM200	100	114 (4½") dia. 8 (5/16") insert	Orange
BM37/2	100	127 (5") dia. 8 (5/16") insert	Orange

Slimline Cistern Float

4½" dia. ball equivalent.



Product Code	Pack Size	Dimensions (mm)	Colour/Finish
BM112	10	89 (3½") dia. 140 (5½") long 8 (5/16") insert	Blue

Cistern Float

For hot or cold water.



Product Code

BM97/1

Pack Size

10

Dimensions (mm)

152 (6") dia.
8 (5/16") insert

Colour/Finish

 Orange

Bottle Trap 76mm Seal



Product Code

BM715

Pack Size

5

Dimensions (mm)

32

Colour/Finish

 White

Low Level Bath & Shower Trap 20mm Seal



Product Code

BM144

Pack Size

1

Dimensions (mm)

40

Colour/Finish

 White

Swivel 'S' Trap 38mm Seal



Product Code

BM154

Pack Size

5

Dimensions (mm)

40

Colour/Finish

 White

Washing M/C 76mm Seal



Product Code

BM159

Pack Size

5

Dimensions (mm)

40

Colour/Finish

 White

Appliance Half Trap 76mm Seal



Product Code

BM705

Pack Size

5

Dimensions (mm)

40

Colour/Finish

 White

Flexible Waste Pipe



Product Code	Pack Size	Dimensions (mm)	Colour/Finish
BM667	10	32 (1¼") Extends from 290 - 800	■ White
BM668	10	38 (1½") Extends from 290 - 800	■ White

Flexible Pan Connector



Product Code	Pack Size	Dimensions (mm)	Colour/Finish
BM669	1	102 (4") Extends from 230 - 800	■ White

Fast-Fix Pan Connectors



Product Code	Pack Size	Dimensions (mm)	Colour/Finish
BM671 (90° bend with spigot)	10	165 (6½") long	■ White
BM673 (straight extension)	10	260 (10¼") long	■ White
BM674 (offset straight connector)	10	110 (4½") long	■ White
BM100 (internal flush pipe connector)	50	25 (1") long	■ White

Sink, Tap & Bath Overflow Stoppers



Product Code	Pack Size	Dimensions (mm)	Colour/Finish
BM59/1/C	25	15 (½")	☑ Chrome plated ABS
BM59/2	25	15 (½")	■ White plastic
BM66/1/C	25	22 (¾")	☑ Chrome plated ABS
BM36	50	15 (½")	■ Black plastic

Air Admittance Valves (BSEN 12380)

For internal use.
BBA approved.



Product Code	Pack Size	Dimensions (mm)	Colour/Finish
BM679	1	110	■ Grey
BM679/B	1	110	■ Black



Universal Flush Pipe Connector

Product Code	Pack Size	Dimensions (mm)	Colour/Finish
BM57/2	50	For 32 (1¼") and 38 (1½") flushpipes	<input type="checkbox"/> White
BM28/2	50	For 32 (1¼") flushpipes	<input type="checkbox"/> White



Flush Pipes

Product Code	Pack Size	Dimensions (mm)	Colour/Finish
BM682	10	355 x 229 (14 x 9")	<input type="checkbox"/> White
BM684	10	457 x 457 (18 x 18")	<input type="checkbox"/> White



Cistern Pull

Product Code	Pack Size	Dimensions (mm)	Colour/Finish
BM58	10	560 chain (22")	<input checked="" type="checkbox"/> Chrome plated chain <input type="checkbox"/> Grey handle



Large Industrial Sink Plunger

Product Code	Pack Size	Dimensions mm	Colour/Finish
BM506	5	Cup 125 (5") Handle 250 (10")	<input checked="" type="checkbox"/> Black & white
BM508	5	Cup 100 (4") Handle 340 (14")	<input checked="" type="checkbox"/> Black & white



Square Gully Grid

Product Code	Pack Size	Dimensions (mm)	Colour/Finish
BM44/1	50	150 x 150 (6 x 6")	<input checked="" type="checkbox"/> Black



Round Gully Grid

Product Code	Pack Size	Dimensions (mm)	Colour/Finish
BM76/2	25	150 (6") dia.	<input checked="" type="checkbox"/> Black
BM76/3	25	178 (7") dia.	<input checked="" type="checkbox"/> Black



Drain Cover

Product Code	Pack Size	Dimensions (mm)	Colour/Finish
BM46	12	300 x 300	■ Black



Balloon Guards

Non-corrosive.

Product Code	Pack Size	Dimensions (mm)	Colour/Finish
BM38/1	50	63 (2½")	■ Black
BM38/7	50	100 (4")	■ Black



Sealing Plate & Frame

Product Code	Pack Size	Dimensions (mm)	Colour/Finish
BM81/1	10	150 x 150 (6 x 6")	■ Black plate & frame □ White PVC seal



Drain Testing Plug

Product Code	Pack Size	Dimensions (mm)	Colour/Finish
BM85/1	1	100 X 15 (4 x 1/2")	□ White
BM85/2	1	150 X 15 (6 x 1/2")	□ White



Drain Rod Pack

Product Code	Pack Size	Dimensions (mm)	Colour/Finish
BM520	1 (10 rods per pack)	915 x 22 (3' x ¾")	■ Black rods, brass joints



Drain Rod Advanced Pack

Includes 4" nylon plunger & steel wormscrew.

Product Code	Pack Size	Dimensions (mm)	Colour/Finish
BM527	1 (10 rods per pack)	915 x 22 (3' x ¾")	■ Black rods, brass joints

Flambeau Europlast Ltd.
Manston Road,
Ramsgate,
Kent
CT12 6HW
UK

T: 01843 854002
E: stadium@flambeau.com

www.stadiumbuildingproducts.com