

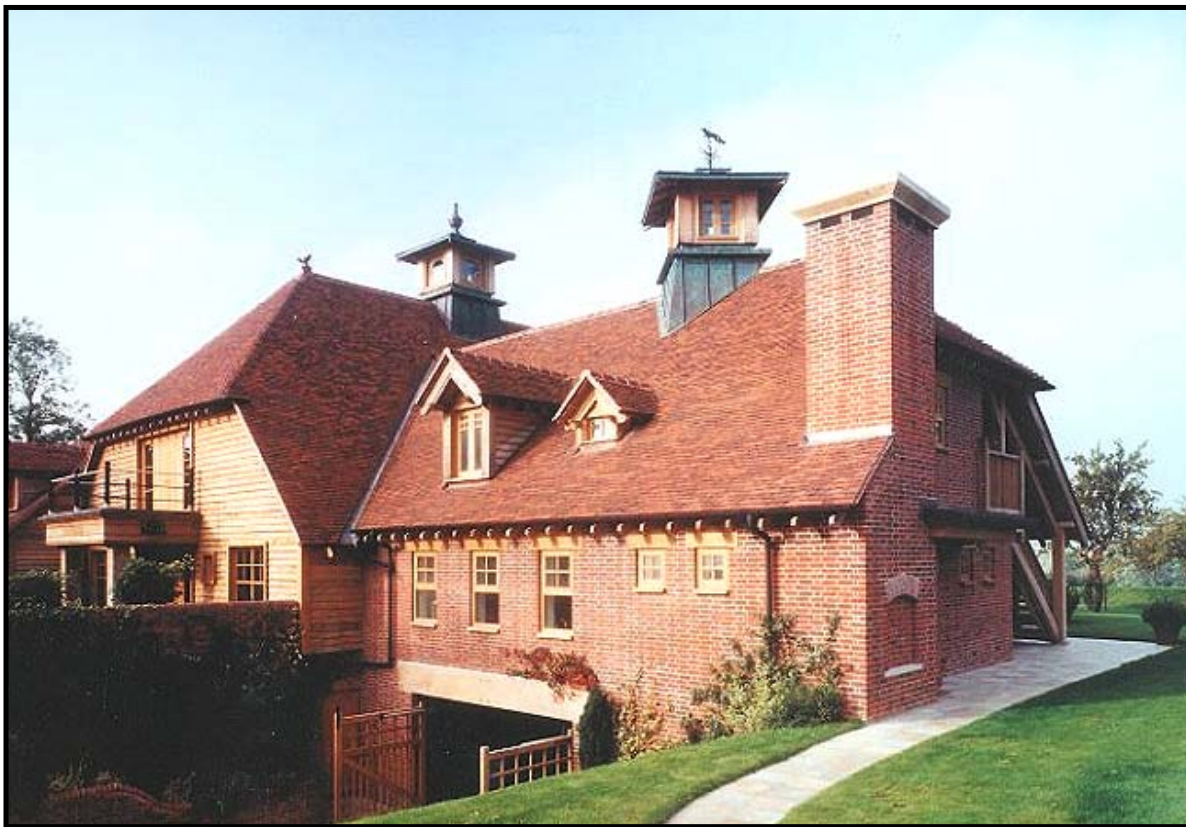

Clay Roof Tile Council

Clay Plain Tiling



Prepared by : The Technical Committee of the Clay Roof Tile Council, 2004



Acknowledgements

This document was prepared by the Technical Committee of the Clay Roof Tile Council.

The Clay Roof Tile Council is the United Kingdom trade association for the manufacture and promotion of clay roof tiles.

The members of the Clay Roof Tile Council are:

Daniel Platt Ltd.
Eternit Building Materials Ltd.
Hinton, Perry and Davenhill Ltd.
Keymer Tiles Ltd.
Lafarge Roofing Ltd.
Sandtoft Roof Tiles Ltd.

Special thanks are extended to Denise Brooks, Richard Davenhill, Roger Gradwell, Ken Hamilton, Andrew McRae, John Mercer, Chris Thomas and Bill Wilkes without whose contributions the document could not have been prepared.

The Health and Safety section includes text and drawings copied with permission from Mr Chris Laughton's 'Methods of Mounting Solar Thermal Collectors on UK Roofs'. (The Solar Design Company, 2002)

Published: 2004



CONTENTS

	Page
Acknowledgements	II
Contents list	III
List of illustrations	IV
Foreword	V
Introduction to clay tiles	1
The plain tile in English Architecture	3
Selection of clay plain tiles	6
Definitions	7
Design specification	10
Roof Substructure – strength and Integrity	12
Tiling	20
Design details	22
Repair and maintenance	40
Health and safety	42
Appendix A Material specifications	47
Appendix B Fixing calculations	50
Appendix C References & bibliography	59

List of illustrations

Illustration of terms

1. Illustration of roofing terms
2. Illustration of tiling terms

Typical roof structures

- 3 Roof with insulation at ceiling with impermeable underlay
- 4 Roof with insulation at ceiling with vapour permeable underlay
- 5 Roof with insulation at rafter with impermeable underlay
- 6 Roof with insulation at rafter with vapour permeable underlay
- 7 Roof with insulation at rafter with vapour permeable underlay
- 8 Roof with insulated liner tray system
- 9 Roof with pre-formed insulated roof panel system

Tiling detail

10. Eaves with over fascia ventilation
11. Eaves with soffit ventilation
12. Open eaves with ventilating rafter tray
13. Cottage eaves with over fascia ventilation
14. Bedded verge
15. Cloaked verge (1)
16. Cloaked verge (2)
17. Bedded ridge
18. Dry fixed ridge
19. Bedded monopitched ridge
20. Hip with bonnet hip tiles
21. Hip with arris hip tiles
22. Mitred hip with metal soakers
23. Bedded hip with hip ridge tiles
24. Valley with valley tiles
25. Valley with metal soakers
26. Valley with metal lining
27. Valley with pre-formed GRP valley trough
28. Top edge abutment
29. Ventilated top edge abutment
30. Side abutment with metal soakers
31. Change of pitch
32. Mansard with mansard tiles
33. Mansard with metal flashing
34. Box gutter eaves
35. Bonded gutter with metal lining
36. Pipe flashing
37. Roof window flashings
38. Safety hook fixings
39. Metal saddle to ridge junction

FOREWORD

This guide describes some common roof constructions and tiling details that are likely to occur in new and refurbished roofs. Material specifications are provided and, where appropriate, these refer to new, or, proposed European standards.

The text follows the guidance given in the code of practice for stating and tiling, BS 5534, and includes some of the changes that are being proposed for the next revision of that document. Particular attention has been paid to best practice with respect to the ventilation of the roof space or batten cavity to prevent the buildup of harmful levels of condensation in the roof structure.

Certain recommendations have been included which represent more rigorous specifications than those found in relevant UK and European Standards. The CRTC believes that there are sound technical arguments for recommending what it believes to be Best Practice in such instances. For example, whereas BS 5534 specifies the use of 2.65mm diameter nails for securing the tiles to the battens, the CRTC recommendation is for 3.35mm nails. Designers and contractors may nonetheless exercise their own judgement in these matters bearing in mind both the minimum requirements specified in the relevant Standards and the CRTC recommendations.

A companion guide **Vertical Tiling** is available. This guide pays particular attention to the securing the counterbattens and battens to the wall and also includes comprehensive illustrations of many common design details.



INTRODUCTION TO CLAY TILES

With the increasing sophistication of the housing market, the external characteristics of a house can play as significant a role as the interior appearance in the purchasing decision. Eye pleasing, attractive features on the outside of the building add to its aesthetic appeal and make an immediate impression on the prospective buyers before they walk through the front door. And first impressions last. A clay roof undoubtedly distinguishes a house as a premium 'product' and, to the builder, offers the potential for 'added value' which will exceed the marginal increment to the overall cost of the construction that may be associated with the use of clay tiles.

Clay is a natural material, which in the form of clay tiles has played an integral role in the UK's built environment for over seven hundred years. Clay roof tiles are durable, natural, sustainable products that improve with age and weathering. Their appeal adds value to buildings and enhances the built environment.

Increasingly, concern for the environment is becoming a major influencing factor for the prospective homebuyers and builders. Whether or not they have any influence, buyers are concerned as much about preserving the landscape as they are about the materials used in building and demand natural, sustainable products. Clay tiles are considered by many planners and specifiers, as a sustainable product because of their durability, long term visual effect on the environment, and their properties as a renewable natural resource. These factors, along with the fact that they are being specified increasingly by planners and conservation officers to preserve the character of buildings and the architectural landscape, mean that clay continues to be one of the most desired roofing products. Recent evidence of the increase in the use of clay tiles is demonstrated by the fifty percent increase in the volume of clay tiles produced and sold per annum since 1995.

To support the renewed interest in traditional materials the CRTC members are making sure that a wide range of clay roof tiles are still available, producing more than 50 different colours. These colours range from deep reds, browns, warm oranges and plum coloured hues of heather to the muted blues of Staffordshire. Variations are obtained by controlling the kiln atmosphere to produce the rich heather shades.

Colours of the tile can also be enhanced through the firing process to create a brindle effect, which varies the colour between the outer edge and the centre of the tile. In addition, the firing process ensures that the colour of the tile is permanent and does not fade. A panoramic view of the rooftops of Britain reveals a patchwork of colours, with each region set apart by its own, distinct clay roof tile colour.

Whilst durability is a major factor that influences architects, specifiers, conservation officers and planners, the ageing benefits of clay tiles also feature very highly.

Clay tiles are unique in that they weather favourably and mellow with age, unlike other roofing products, further enhancing the aesthetic appearance of the roof. They not only withstand the elements; they actually improve with exposure.

Clay tiles come in two main formats, the flatter plain tile and the larger format profiled tile. Amongst plain tiles there are also other variations in the tile shapes including camber or curve. Single camber tiles curve from top to bottom which reduces the capillary action between courses, while double or cross camber tiles are also curved from left to right adding another dimension to the roof. A further design dimension can be added by using ornamental tiles, which can have curved edges such as the club and bullnose or beavertail ornamental tiles, a fishtail shape or a pointed end, commonly known as diamond or arrowhead ornamentals.





THE PLAIN TILE IN ENGLISH ARCHITECTURE

Dr. R. W. Brunskill

What's in a name? Roman tiles, Italian tiles, Spanish tiles, even pantiles have something more than a mere name. But the humble plain tile is just plain. Yet the name derives from Latin and was used in medieval documents to describe the 'plane' or flat tile of baked clay as distinct from the various curved tiles which were also used. It is the name still applied to one of the most widespread as well as one of the most versatile of building materials available for covering our roofs and our walls.

The word 'tegula' or tile was used to describe several clay products in the early Middle Ages including bricks and paviors as well as roofing tiles but the special word 'thacktyle' was used certainly from the year 1212 and possibly from as early as 1189 in London. As the term suggests, tiles were used as an alternative to thatch where a more long-lasting, a more uniform, a more predictable, and, above all a more fire-resistant roof covering than thatch or reed or straw was required. This was especially true of urban buildings. Squeezed within their defensive walls, medieval towns were crowded with timber-framed buildings covered with thatch and therefore vulnerable to the spread of fire from roof to roof. From an early date various municipalities attempted to counter the danger by legislating for the use of tiles. Use of plain tiles rapidly spread in town and country until by the 18th Century these were the normal roofing material for a third of the country.

The shape of the plain tiles is sometimes held to derive from the shape of wooden shingles, another alternative to thatch but one almost equally as vulnerable to fire. Many attempts were made to regulate the size of plain tiles. The best known is that made by statute in 1477/8 during the reign of Edward IV in which it was required that a plain tile should be 10½" long by 6¼" wide (most plain clay tiles of the present day are 10½" long by 6½" wide). Since tiles were sold by number, unscrupulous tile-makers were inclined to skimp on dimensions while the building owner expected to have to use the minimum number of tiles to cover his roof. The statutory size made an acceptable compromise though the limitations of a manufacturing process which depended on a mixture of judgement and chance meant that nominal dimensions could not always be maintained.

Bricks and tiles were generally manufactured together. Both tiles and bricks were normally made from clay dug close by the site of the intended buildings, worked and tempered and then burnt in a clamp or kiln made at the building site. Each individual tile was made by hand; it was not until well into the 19th Century that tile-making machines came into use and then more often for pantiles or other shaped tiles than for plain tiles.

From 1784 onwards the price of tiles was affected by the Brick Tax introduced by William Pitt the Younger along with several other ingenious taxes to help defray the cost of fighting the American War of Independence. Taxation records give some idea of the numbers of bricks and tiles manufactured at that time. In 1833, for instance, over 42,000,000 plain tiles were subject to the levy and, while they were produced in many counties of England, the largest producer was Staffordshire with nearly 8,000,000 made at that time. The tax on tiles was in fact removed in 1833; bricks had to wait until 1851 until they were free from tax.

At this time there was competition between tiles and slates for the roofing market and although slates were not taxed as such they were subject to the tax on coast-wise shipping since most were transported by water from the quarries in North Wales and the Lake District.

Traditionally, plain tiles were hung from laths. Each tile had two holes formed near its head. Oak pegs, pushed through one or sometimes two of the holes, were hooked over the laths made of riven oak and nailed to the rafters. In plain tile roofs the position of the hole varied, the shape of the peg varied, the thickness and contour of the lath varied and the rafters varied in size. The tiles were curved in length and had a varying curve in width. Whatever the uniformity of size in the tiles the resulting roof was far from uniform in surface and appearance.

From about 1840, following a patent granted in 1836, there developed the practice of including one or two nibs at the head of each tile in order to hand the tiles from machine-sawn laths. Only certain courses of tiles at the eaves and at levels up the roof were nailed into the laths. A greater degree of uniformity was one result of this changing practice though, in fact, tiles with nibs did not come into general use until late in the 19th Century.

Normally tiles were bedded in some material which would help to keep out draughts and make the roof resistance to the danger of driven snow, a danger which applied even though most plain tiles roofs were laid to a pitch of at least 45deg. The cheapest bedding was hay or moss; it had the advantage of resilience and thickness but needed frequent attention and renewal. Lime mortar was an alternative bedding material and many plain tiles stripped from roofs for possible re-use show signs of this mortar bedding.

In many parts of the eastern and south-eastern counties of England plain tiles were used for wall cladding as well as for roofing. They were especially popular in Kent, Sussex and Surrey. Hung on laths nailed to new or existing timber-framed walls they provided a neat, up-to-date, durable and fire-resistant cladding to such buildings. Shaped tiles giving a scalloped or fish-tail shape were also used alone or with plain roofing tiles.

With clay plain tiles we have an agreeable balance between uniformity and variety. Uniformity comes in shape, size and depth of lap as well as in colour to a certain extent; variety comes in texture both bold (in variations in surface) as well as fine (in the sandy texture of each tile) and in detailed variations in colour from mix and firing and in the way light catches the expanse of a tiled roof. With uniformity and variety in due proportion comes versatility: tiles may follow roof shape or wall shape, tiles may follow ridge or hip, tiles may be laced or swept or moulded up valleys in roofing. Plain tile and brickwork go together in being essentially the same material with the same basic method of manufacture and similar degrees of uniformity, variety and versatility. A set of brick walls with a clay tile roof is of the essence English and very far from plain.

NOTE: This Chapter of the CRTC 'Plain Tiling Guide' is an edited version of a paper prepared in 1985 by Dr. Ronald Brunskill, Reader in Architecture at the University of Manchester, one of Britain's leading architectural historians and the author of many publications on traditional building.



SELECTION OF CLAY TILES

The photographs that follow illustrate the range of colours and colour patterns that can be achieved and the drawings indicate the range of decorative shapes that are available.

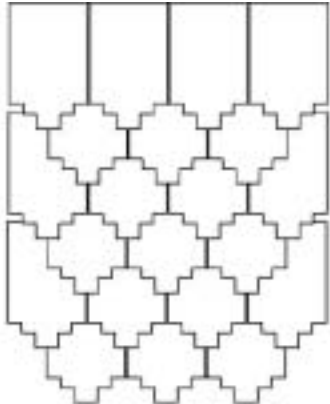

Step

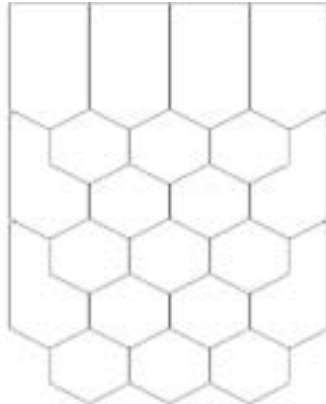

Pointed (also called Arrowhead)

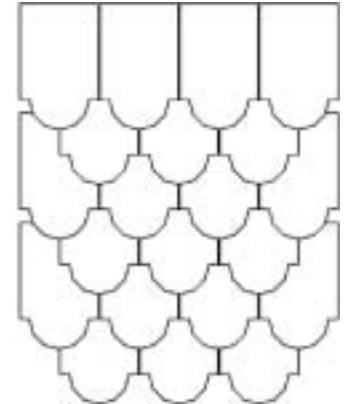

Club

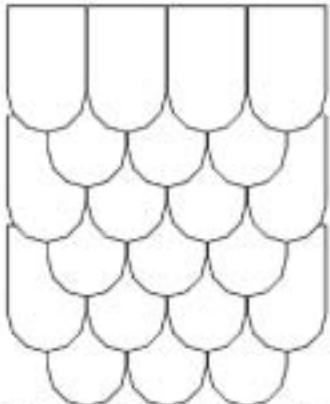

Bullnose (also called Beavertail or spade)

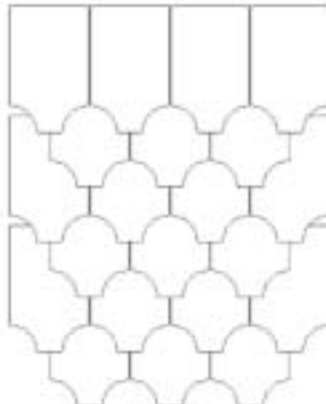

Fishtail

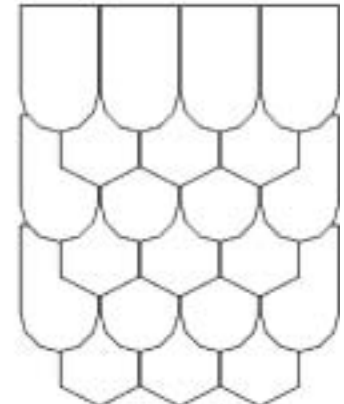

Pointed & Bullnose

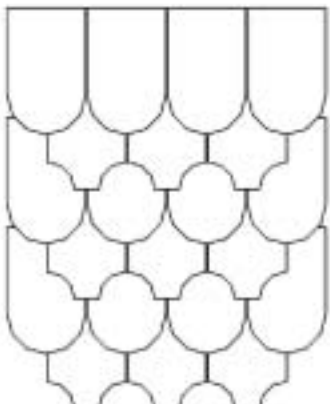

Bullnose & Fishtail

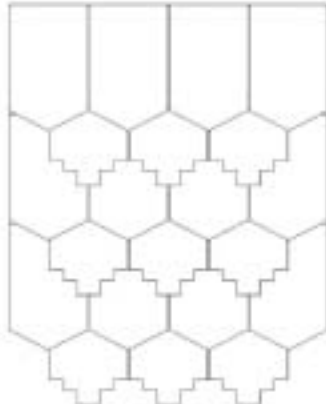

Pointed & Step

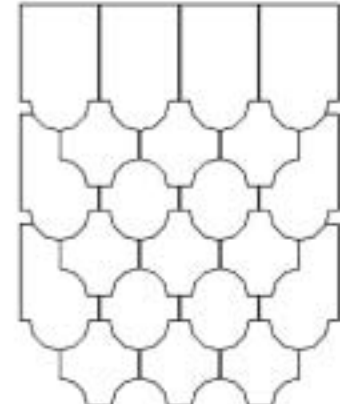

Club & Fishtail



DEFINITIONS

Common roofing terms

Drawing 1 illustrates general roofing terms.

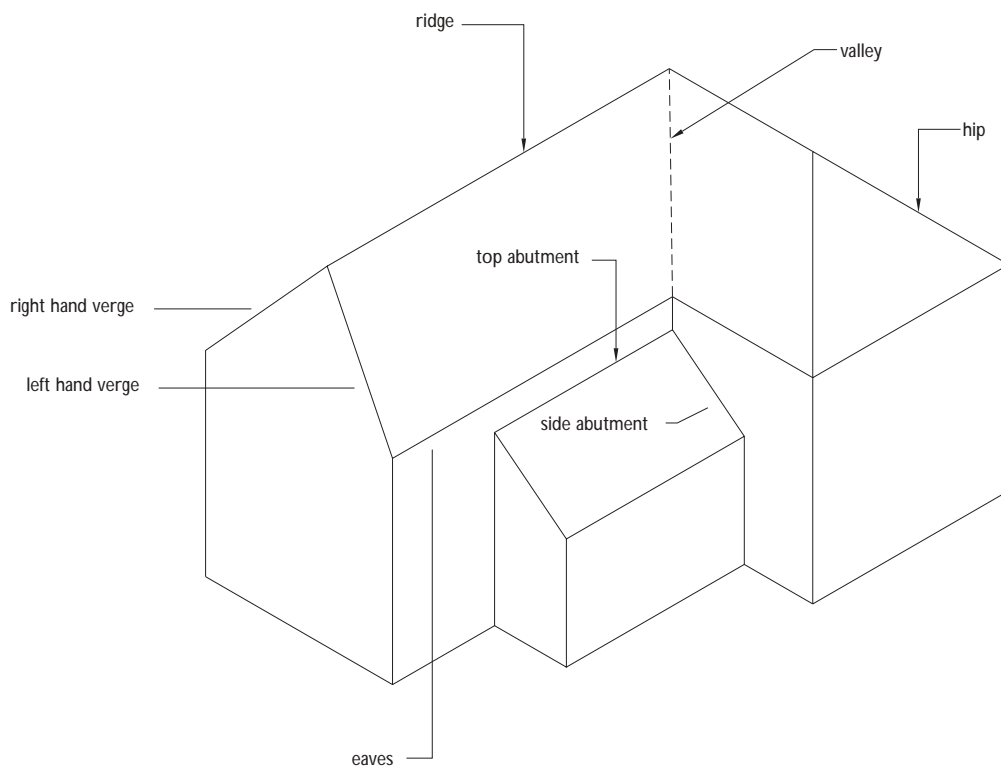

Plain tiles

Drawing 2 illustrates the common terms used, e.g., gauge, headlap, sidelap, pitch, eaves/top tiles, etc.

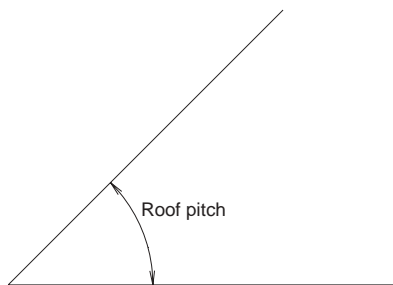
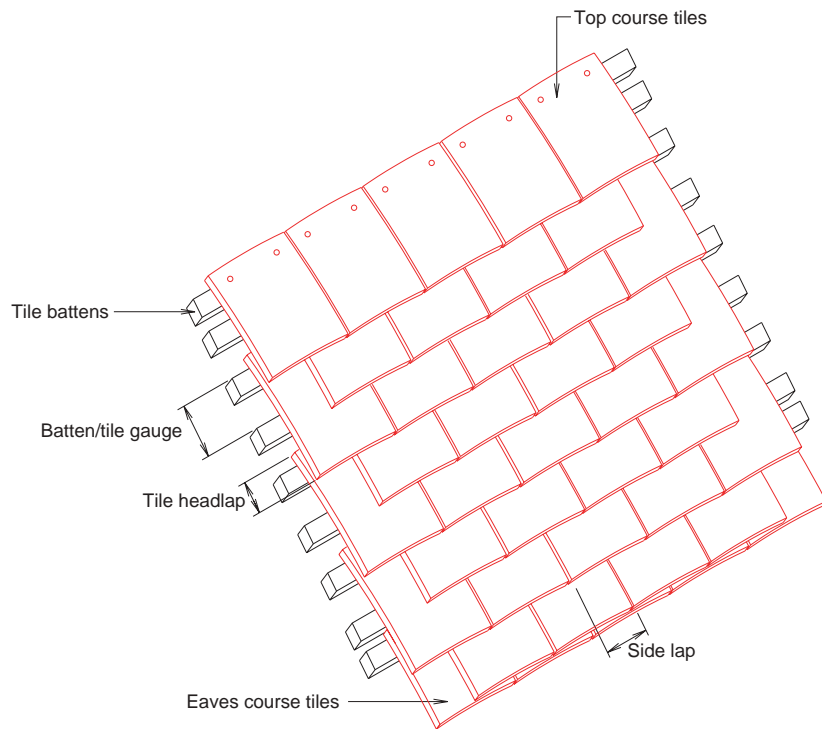

Fittings

Clay roof tile fittings are made of clay and are used in combination with tiles to complete the roof covering, e.g. hips and valleys. Below are several examples.

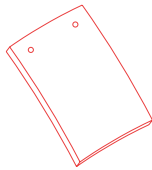

Plain Tile
265 x 165mm

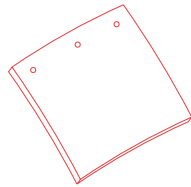

Gable (or verge) Tile
265 x 247mm

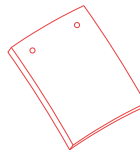

Eaves/Tops Tile

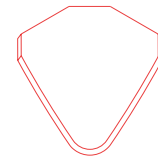

Valley Tile

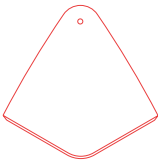

Arris Hip Tile



Bonnet Hip Tile

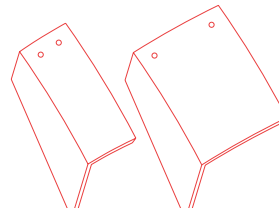

Cloaked Verge Tiles

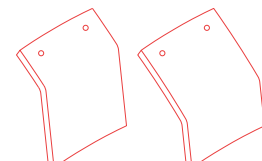

Mansard Tiles

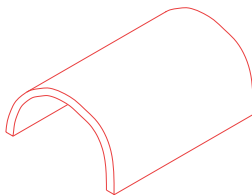

Half Round Ridge

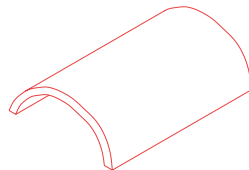

Third Round Hip Ridge

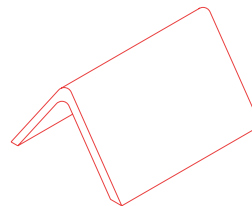

Angle Ridge (in angles to suit roof pitch)

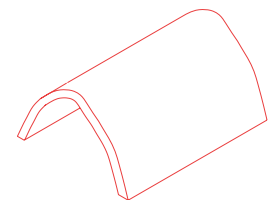

Hogsback Ridge

Accessories

May be made of clay or other materials and they are used in combination with clay tiles to fulfil a functional requirement of the roof, e.g., ventilation tiles

DESIGN SPECIFICATION

Introduction

This chapter outlines the key issues that need to be considered during the design stage of a roof. The design issues are listed under *Prescriptive design specifications* and *Performance design specifications*.

Prescriptive design specifications :

Rafter / pitch

Clay plain tiles conforming to the dimensional tolerances given in EN 1304 can be laid on rafter pitches down to a minimum of 35°. Plain tiles which, for aesthetic reasons, do not comply with the dimensional tolerances given in EN 1304 must be laid at pitches not less than 40°.

Head and sidelap

The headlap specification in BS 5534 is 65 mm minimum and the maximum gauge of battens should be 100 mm. Gauges of less than 88 mm are not recommended.

The sidelap should be not less than one third the width of the tile, typically 55 mm.

Performance design specifications:

Wind load

On the lee side of a building the wind can create a suction on the tiles and the vacuum effect can be significantly higher adjacent to the perimeters. The methods for calculating the wind uplift load are given in BS 5534 and BS 6399 and an outline of the calculation method, and examples, are given in appendix B.

The minimum fixing specification for plain clay tiles is to fix every fifth row but in all cases uplift calculations should always be completed to ensure that the specification meets the wind load requirements.

Where the calculation indicates that the tiles are to be mechanically fixed and the minimum fixing specification of two smooth nails does not meet the calculated wind uplift resistance, alternative fixing methods must be used, e.g. improved nails (ring shank), screws, clips and proprietary fixings.

Traditionally peg tiles are not nailed; rather, they are once pegged to allow them to be aligned in horizontal coursing.

Note: The Building Research Establishment has published a guide that describes the effect of aircraft vortices on roofs and gives recommendations for the fixing of tiles in areas that are on the flight path of aircraft taking-off and landing.

Control of Condensation

The method of ventilation should be established prior to the assembly of the roof covering. The position of the roof insulation will affect the method of ventilation and the illustrations describe examples where the insulation is at ceiling height (cold roofs) and at rafters (warm roofs). The ventilation methods must also take into consideration the type of underlay that will be used, e.g., bituminous felts, vapour permeable underlays.

The method of assessment given in BS 5250 should be used and where the risk of condensation is identified appropriate ventilation should be provided and / or a vapour control layer should be incorporated within the structure.

Rain and snow resistance

The lap arrangement in BS 5534 for plain clay tiles provides an excellent rain and snow protection system.

Tile durability

Tiles that meet the stringent requirements of BS EN 1304 have demonstrated that they have the necessary durability for the UK environment.

Thermal capacity

The thermal insulation contribution of clay tiles and batten cavity (0.17R) can be ignored. The product properties are specifically related to water impermeability, durability and aesthetics and it is the role of the insulation and other products to provide the necessary thermal performance for the building.

Fire resistance

Clay tiles are deemed-to-satisfy the UK building regulations with respect to external fire performance.

The European external fire test will not apply to clay tiles because they are incombustible and have a reaction to fire rating better than class A2.

Note: The resistance to the spread of fire through the soffit into roof is a requirement for multiple occupancy buildings (Building Regulations Section 9 Concealed Spaces and B4 External Fire Spread).

Insect and bird resistance

The correct design and installation of a plain clay tile roof will ensure that the ingress of insects and birds to the loft or wall structure is prevented.

ROOF SUBSTRUCTURE - strength and integrity

Clay tiles can be put on a wide range of substructures. It would not be possible to illustrate every combination of roof structure and tile fixing method. Nevertheless, the range of examples given below should meet the needs of most new and replacement roofs.

Illustration number

3. Roof with insulation at ceiling with impermeable underlay
4. Roof with insulation at ceiling with vapour permeable underlay
5. Roof with insulation at rafter with impermeable underlay
6. Roof with insulation at rafter with vapour permeable underlay
7. Roof with insulation at rafter with vapour permeable underlay
8. Roof with insulated liner tray system
9. Roof with pre-formed insulated roof panel system

The design of the roof substructure, e.g. rafters, and the securing of the substructure to the building are not within the scope of this guide.



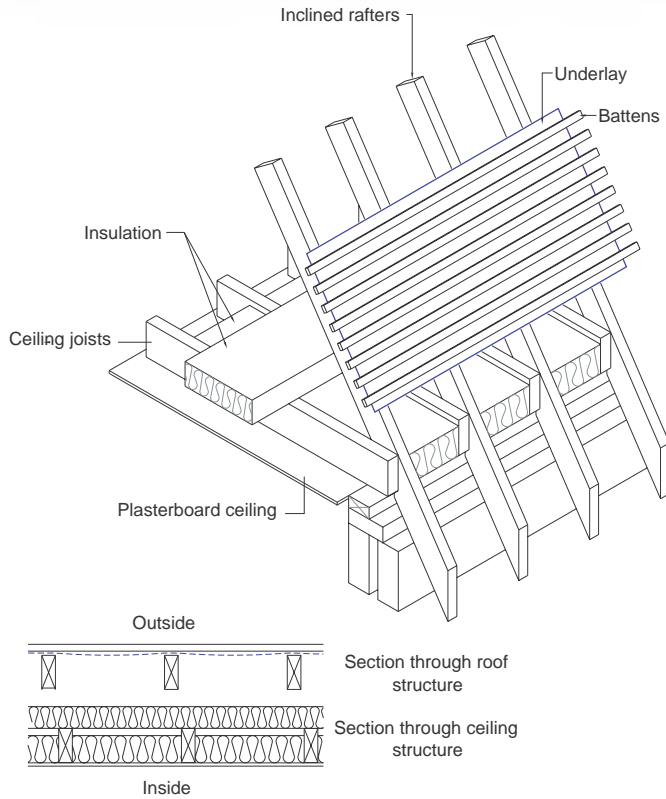

3) Roof structure - insulation at ceiling with impermeable underlay

This is a traditional roof detail with a ventilated roof space and horizontal ceiling. Ventilation should be provided into the roof space in accordance with Building Regulation F2 and British Standard BS 5250.

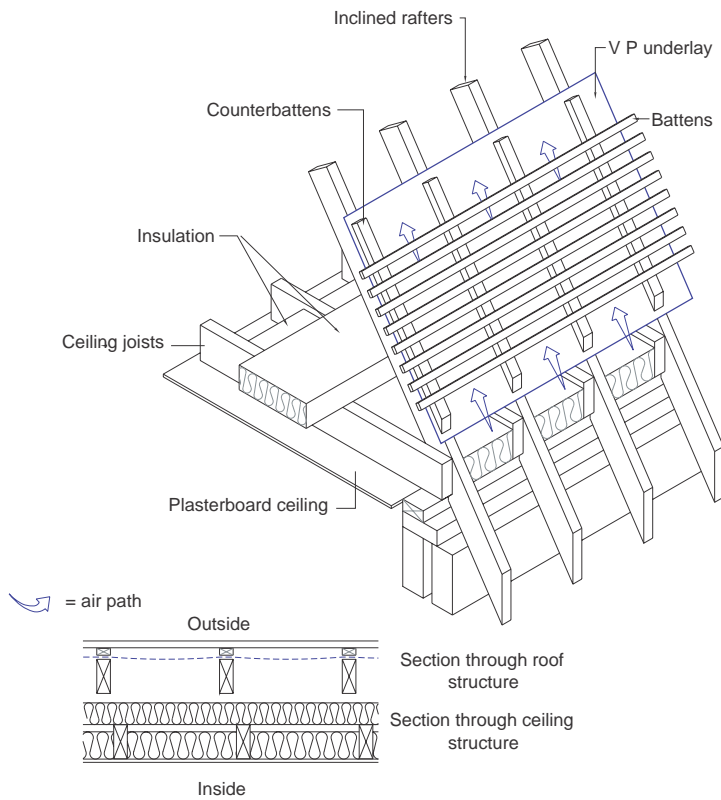

4) Roof structure - insulation at ceiling with vapour permeable underlay

This roof detail shows a horizontal ceiling and using a vapour permeable underlay without roof space ventilation. It is recommended that there is a minimum 50mm gap between the underlay and the tiles to allow adequate air movement in the batten cavity. To provide this a minimum 25mm deep counterbatten should be fixed over the rafters. Low and high level ventilation should be provide to the batten cavity.

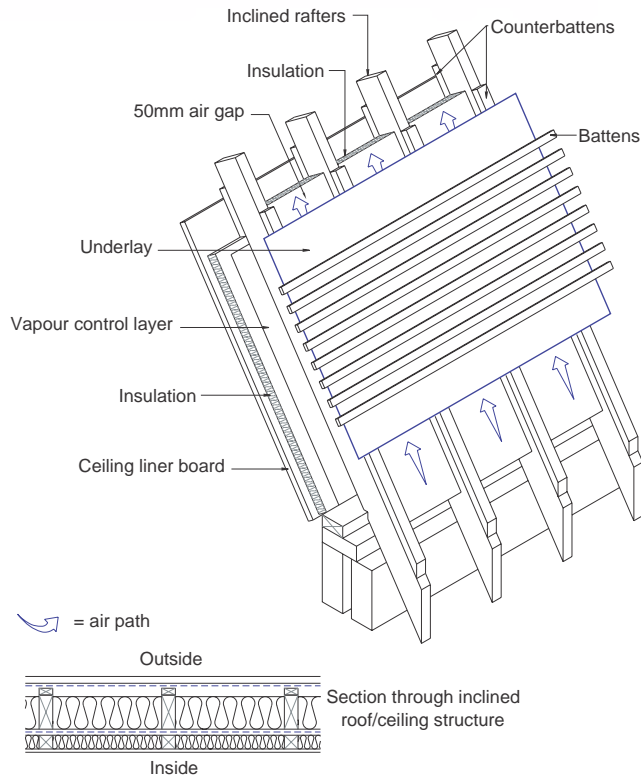

5) Roof structure - insulation at rafter with impermeable underlay

This detail shows a sloping ceiling and uses a non-vapour permeable underlay and is suitable where there is a room in the roof space. Insulation is fitted between the rafters. It is recommended that there is a minimum 50mm gap between the insulation and the underlay. Counterbattens can be used to provide this gap. A 25mm wide continuous ventilation gap is required at low level and a 5mm wide continuous ventilation gap is required at high level.

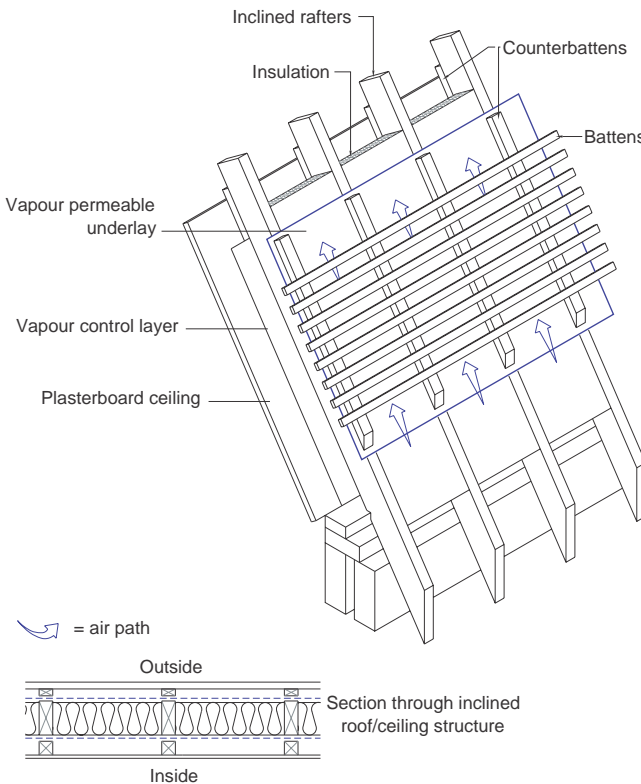

6) Roof structure - insulation at rafter with vapour permeable underlay (V1)

This detail shows a sloping ceiling and uses a vapour permeable underlay without roof space ventilation and is suitable where there is a room in the roof space. Insulation is fitted between the rafters. It is recommended that there is a minimum 50mm gap between the underlay and the tiles to allow adequate air movement in the batten cavity. To provide this a minimum 25mm deep counterbatten should be fixed over the rafters. A 25mm wide continuous ventilation gap is required at low level and a 5mm wide continuous ventilation gap is required at high level. Counterbattens are used between the rafters and plasterboard to reduce the number of perforations through the vapour control layer.

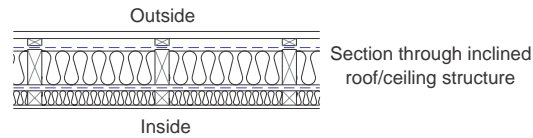
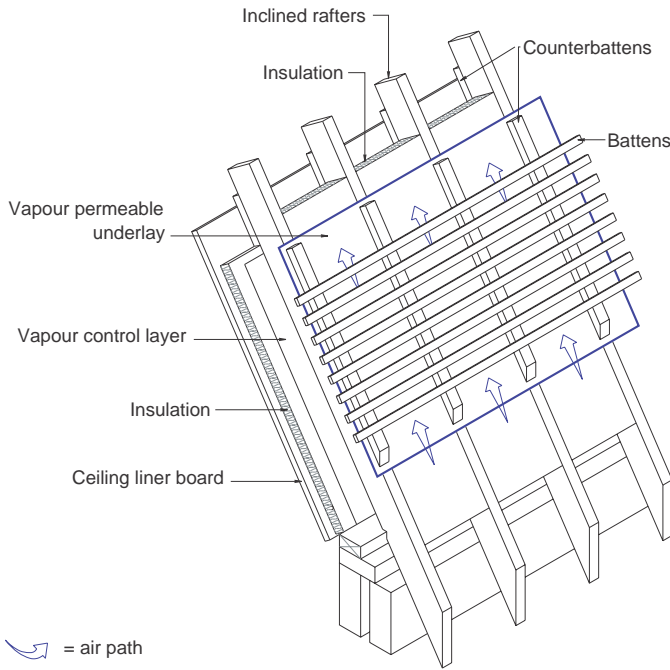

7) Roof structure - insulation at rafter with vapour permeable underlay (V2)

This detail shows a sloping ceiling and uses a vapour permeable underlay without roof space ventilation and is suitable where there is a room in the roof space.

Insulation is fitted between the rafters. It is recommended that there is a minimum 50mm gap between the underlay and the tiles to allow adequate air movement in the batten cavity. To provide this a minimum 25mm deep counterbatten should be fixed over the rafters.

A 25mm wide continuous ventilation gap is required at low level and a 5mm wide continuous ventilation gap is required at high level.

This is a variation on detail (5) incorporating an additional layer of insulation between the rafters and ceiling.

= air path

8) Roof Structure - insulated liner tray system

This detail shows the use of a metal liner tray system fixed to horizontal steel purlins. Rigid insulation is positioned between the upstands of the liner tray. Permeable underlay is laid over the upstands and counterbattens are secured to the upstands using proprietary fixings as recommended by the liner tray manufacturer. Tile battens are then nailed to the counterbattens in the usual way.

A suspended ceiling system is used (not shown).

(Advice should be sought from the liner tray manufacturer)

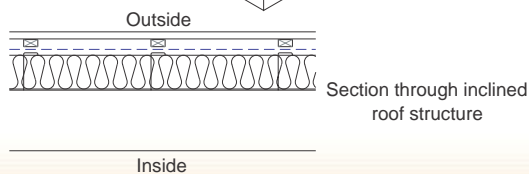
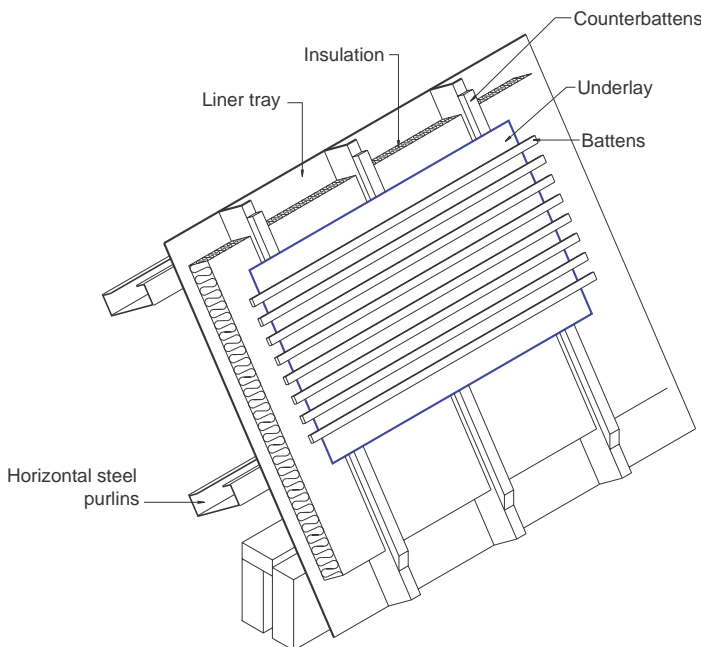

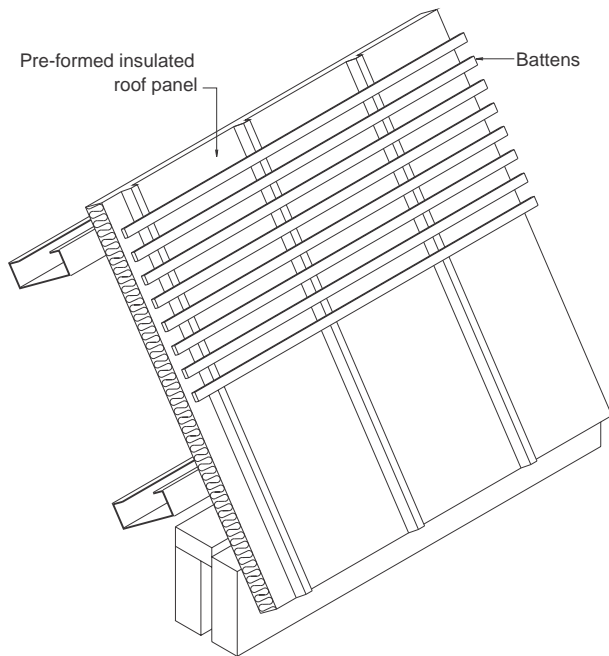

9) Roof Structure - Pre-formed insulated liner tray system

This detail shows the use of a metal pre-formed liner tray system with insulation 'sandwiched' between lower and upper metal panels. The system is fixed to horizontal steel purlins.

Tile battens are secured directly to the panel using proprietary fixings as recommended by the liner tray manufacturer

A suspended ceiling system is used (not shown).

(Advice should be sought from the liner tray manufacturer)

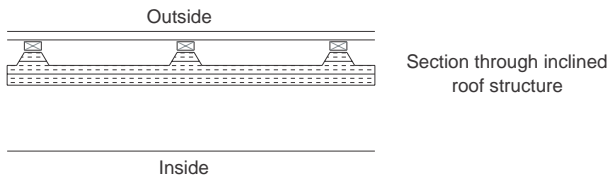

Batten and counterbatten security

The methods for securing the battens and the counterbattens will depend on the type of rafter construction. Nails of various designs are used with cut timber roofs and trussed rafter roofs and proprietary fixings are used with metal rafter roofs. The calculation method for determining the number and type of fixings for securing the battens and counterbattens is described in Annex B. Advice on fixing should be sought from the fixings manufacturer and, where required, the manufacturer of metal rafters.

Installation of underlay

Underlay overlaps in the main roof should be in accordance with the following:

- for sidelaps: not less than 100mm;
- for headlaps: not less than 100mm when not fully supported
not less than 75mm when fully supported

All penetrations, pipes, vents, etc. through the underlay should be suitably detailed to prevent water ingress.

Purpose designed devices which open laps of the underlay are not recommended.

Where an underlay overlap does not coincide with the batten, consideration should be given to either including an extra batten at the overlap or increasing the underlay lap to coincide with the next batten.

Eaves and bottom edge

Consideration should be given to the following when laying underlay on the eaves and bottom edge of the roof:

- a) the underlay or its replacement should be detailed to extend over the fascia board and tilting fillet and into the gutter to allow effective rainwater drainage;
- b) ponding or water traps at the eaves should be prevented;
- c) the underlay extending into the gutter should not significantly affect the flow of rainwater in the gutter.

Note. Some underlay materials may degrade in this exposed position. It is recommended that an underlay of a more durable material is used, e.g. type 5U as specified in BS 747, or a proprietary eaves device.

Verges

Underlay intended for use on verges should lap onto the outer skin of the brickwork by 50mm in the case of an overhanging verge, onto a flying rafter. (For further guidance in the construction of verges see BS 8000: part 6: 1990 sections 3 and 4).

Note. Where proprietary verge tiles or systems are specified, detailing should be in accordance with the manufacturer's recommendations which are relevant to UK conditions of use.

Ridge

For duo pitched roofs, underlay from one side of the roof ridge should overlap the underlay on the other side by not less than the minimum recommended headlaps given in the table.

For mono pitched roofs, underlay should extend over the mono ridge and top fascia board by not less than 100mm.

Note. Where proprietary ventilating ridge tiles or dry ridge systems are specified, detailing should be in accordance with the manufacturer's recommendations that are relevant to UK conditions of use.

Hips

Underlay courses should overlap at the hip line by not less than 150mm.

Valleys

Underlay for use on valleys should be laid from side to side. Each course should lap past the centre-line of the valley by not less than 300mm. Where a continuous length of underlay is laid in the valley, each course of felt from either side should be cut to mitre at the centre-line of the valley and lap onto the continuous length by not less than 300mm.

Metal and plastic valley materials and units should not be laid directly onto underlays where there is a risk of adhesion. Such adhesion can inhibit the free drainage of any moisture, resulting in accelerated failure of the underlay. Likewise, adhesion can result in the premature failure of the valley material or units. Where premature failure of the underlay or lining material may happen, the underlay should be cut to the valley and lapped onto the liner.

Junctions

Underlay should overlay roof junctions by a minimum of 150mm in each detail.

Abutments (side and top edges)

Underlay should be turned up the abutment by not less than 50mm under the flashings.

Back abutment

Underlay should be detailed to lap over the material forming the back gutter by 100mm to 150mm, depending upon the pitch of the roof. Ponding or water traps behind the tilting fillet should be prevented by design.



TILING

The setting out of battens needs to take into account the top and bottom of the roof and the openings through it, such as dormer windows or roof lights. The top of the roof and the bottom edge are called fixed points and the top and bottom of each opening are also defined as fixed points. The fixed points are used to calculate the batten gauge. For example, on a roof with one roof-window, the bottom edge of the roof and the lower edge of the roof-window will be used to calculate the batten gauge between these two points, and the bottom of the roof-window and the top of the window are used to determine the batten gauge on this section of the roof, etc.

Starting at the eave of the roof a full length tile is positioned to ensure that it overlaps the gutter by 50mm and the height of the barge board adjusted, taking into consideration the thickness of the eaves tile, to ensure that the tile will lie in the same plane as the other tiles when they are placed on the roof. The position of the underside of the nibs are marked on the underlay and the process repeated at various positions along the roof. Ideally, all the marks should be in the same horizontal plane. If they are not, either one will need to be adopted as the common datum, or, a step in the tiling will need to be arranged at a suitable feature such as an abutment. Where a step is planned the difference in level should be a module of the tile gauge, which can be a maximum of 100mm. Having set out the line of the top of the first batten, it should be nailed in position.

With the first batten in position, the batten for the eaves tile (eaves / top tiles are shorter in length than a standard tiles) can be located such that there is just enough space between the bottom of the first batten and the top of the eaves tile batten to allow the head of the eaves tile, including nibs, to slide between them. Provided the tile battens are no wider than 38mm the eaves tile should not hang lower than the first tile course.

Rising up the roof, identify the first fixed point; which in the example would be the lower edge of the roof-window. The top tile course (using eaves / top tiles) is set out to allow the head of the top tile, including the nibs, to fit under the windowsill. With the batten in place, the last full tile batten can be located to allow just enough space between the bottom of the top tile batten and the top of the last full tile batten, to allow the last full tile to slide between them. Provided the tile batten is no wider than 38mm the top tile should provide adequate cover for the last full tile course. If the distance between the eaves course and the first fixed point is relatively short (less than 450mm) it may be difficult to set a gauge that reaches the windowsill and a decision to have a longer flashing may need to be made.

Between the top of the first and the last full tile courses of any fixed points, the intermediate battens will need to be set out to ensure that the gauge; which is the distance from the top of one batten to the top of the next batten, is not greater than 100mm. This is achieved by measuring the overall gauge distance and dividing it by 100mm. The answer to the calculation will be a whole number and a decimal point. Whatever the whole number is, increase it by one and divide that number into the gauge distance. The answer to this calculation will provide the gauge to which the intermediate battens should be set.



The next fixed point in the roof needs to be identified and in the example this would be the top of the roof-window and set out depending upon whether it is a bottom edge or top edge, and the battens between them gauged out equally until the last full tile batten is reached.

The top of the roof has the top course (using eaves / top tiles) set out to allow the head of the top tile, including the nibs, to fit under the ridge. Once this batten is in place, the last full tile batten can be located to allow just enough space between the bottom of the top tile batten and the top of the last full tile batten, to allow the last full tile to slide between them. Provided the tile batten is no wider than 38mm the top tile should provide adequate cover for the last full tile course.

All tile battens should be horizontal (level) and straight, with no sags. No batten should be less than 1200mm long. Joints should be square cut and butted centrally over rafters and must not occur more than once in any group of 4 battens on any one support.

Having set out and nailed all the battens the setting out of tiles on each batten needs to be considered. Each plain tile is 165mm wide and should have a gap of up to 3mm between them. The first whole course of tiles should be set out to equalise all the gaps between the tiles, start and finish at corner or abutments and line up with the sides of window openings. Having settled on an arrangement, the batten should be marked every third or fifth joint. Near the last full tile course, the process should be repeated and plumb lines dropped to ensure that the tile joints are vertical, and the battens marked.

The eaves course of tiles are laid broken bond to the first full course of tiles so may need an eaves tile and half; these can be made by cutting a full tile-and-a-half down to the same length as the eaves tile. The same may apply at the top tile course and is more critical since it is more visible.

At roof-window reveals it may be necessary to finish with a cut tile-and-a-half on each course to maintain the vertical perpendicular joints.

Tiles should always be mixed from at least three pallets to ensure that any variations in shade and colour give an aesthetically pleasing effect.

DESIGN DETAILS

The following illustrations and text explain the common design details that can occur on refurbishment and new work.

Illustration number

10. Eaves with over fascia ventilation
11. Eaves with soffit ventilation
12. Open eaves with ventilating rafter tray
13. Cottage eaves with over fascia ventilation
14. Bedded verge
15. Cloaked verge (1)
16. Cloaked verge (2)
17. Bedded ridge
18. Dry fixed ridge
19. Bedded monopitched ridge
20. Hip with bonnet hip tiles
21. Hip with arris hip tiles
22. Mitred hip with metal soakers
23. Bedded hip with hip ridge tiles
24. Valley with valley tiles
25. Valley with metal soakers
26. Valley with metal lining
27. Valley with pre-formed GRP valley trough
28. Top edge abutment
29. Ventilated top edge abutment
30. Side abutment with metal soakers
31. Change of pitch
32. Mansard with mansard tiles
33. Mansard with metal flashing
34. Box gutter eaves
35. Bonded gutter with metal lining
36. Pipe flashing
37. Roof window flashings
38. Safety hook fixings
39. Metal saddle to ridge junction

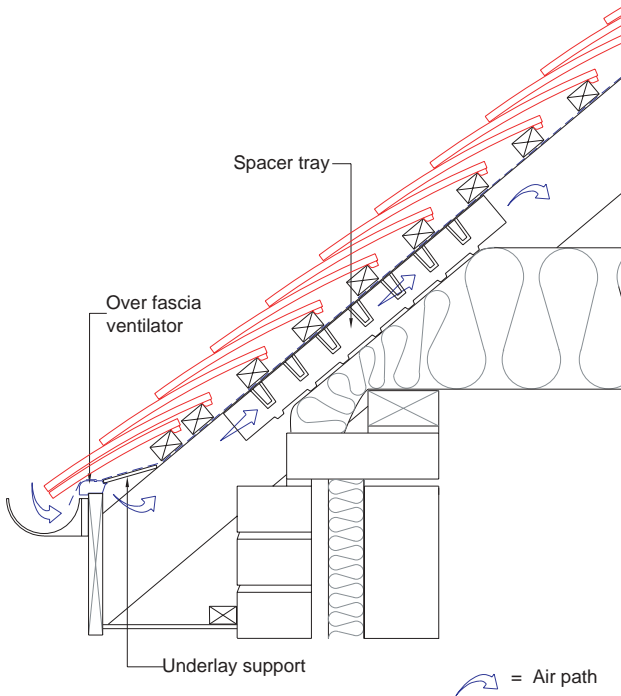

10) Eaves with over-fascia ventilation

Set top of fascia board at correct level and fit ventilator in accordance with Manufacturers Recommendations. Eaves courses of tiles should be at same pitch as general tiling. If a sprocketed or bell-cast detail is used, then eaves courses should be no lower than the minimum recommended roof pitch.

Fix a plywood board or proprietary tray to provide continuous support to underlay to prevent water retaining troughs.

Fix a rafter spacer tray to provide a clear air path between underlay and insulation.

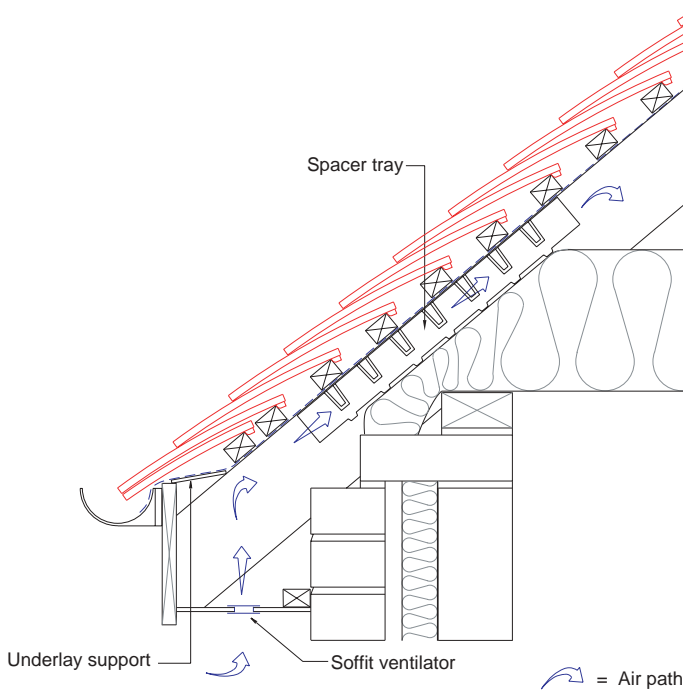

11) Eaves with soffit ventilation

Set top of fascia board at correct level. Eaves courses of tiles should be at same pitch as general tiling. If a sprocketed or bell-cast detail is used, then eaves courses should be no lower than the minimum recommended roof pitch.

Fix a plywood board or proprietary tray to provide continuous support to underlay to prevent water retaining troughs.

Fix a rafter spacer tray to provide a clear air path between underlay and insulation.

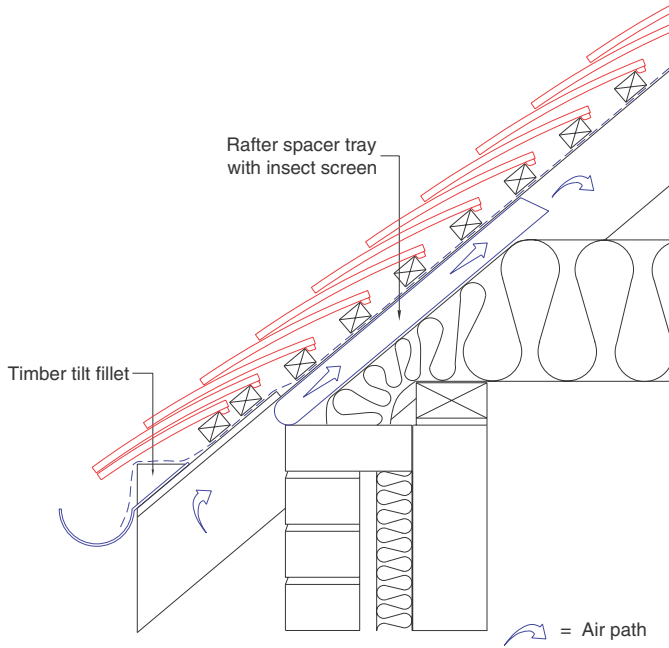

12) Open eaves with ventilating rafter tray

Fix timber fillet to set eaves courses of tiles at same pitch as general tiling. If a sprocketed or bell-cast detail is used, then eaves courses should be no lower than the minimum recommended roof pitch. Fix a screen to prevent ingress of birds, rodents and large insects etc, or use proprietary rafter spacer tray with integral screen to provide a clear air path between underlay and insulation.

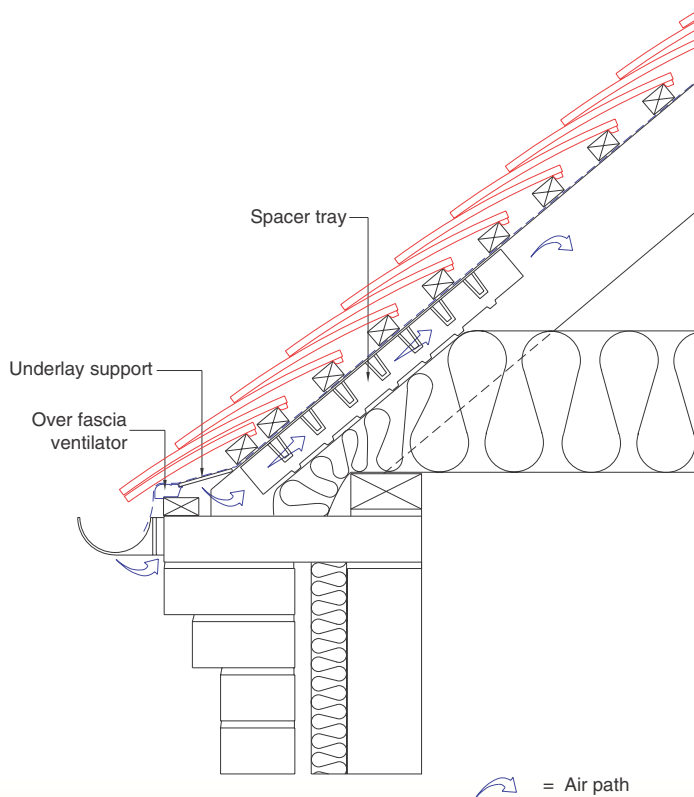

13) Cottage eaves with over-fascia ventilation

Fix a timber batten to outer edge of masonry to provide fixing for over fascia ventilator. Use correct thickness of timber to set eaves courses of tiles at same pitch as general tiling. Fit ventilator in accordance with Manufacturers Recommendations. If a sprocketed or bell-cast detail is used, then eaves courses should be no lower than the minimum recommended roof pitch. Fix a plywood board or proprietary tray to provide continuous support to underlay to prevent water retaining troughs. Fix a rafter spacer tray to provide a clear air path between underlay and insulation.

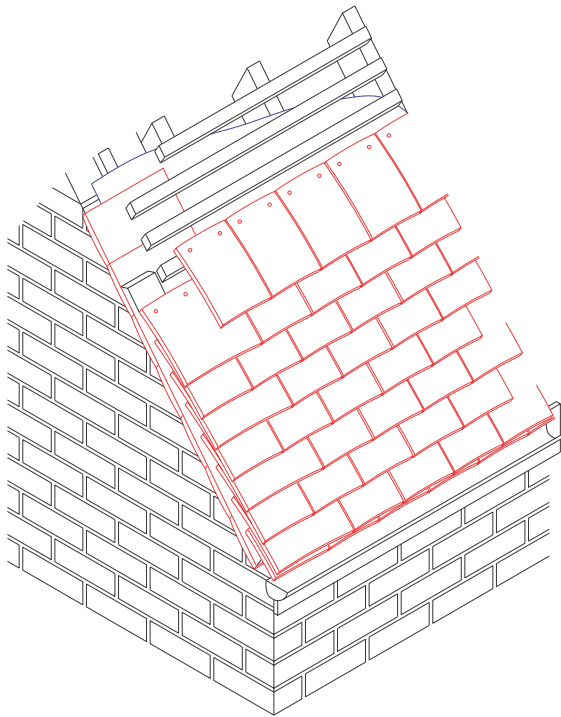

14) Bedded verge

Carry underlay 50mm onto outer leaf of gable wall.
Bed an undercloak of plain tiles laid face down with bottom ends exposed, projecting not more than 50mm beyond face of wall.

Carry tiling battens over undercloak and finish 100mm from verge edge.
Fix standard tiles and tile-and-a-half tiles in alternate courses.

Bed edge of verge tiles flush with undercloak on 75mm wide bed of mortar leaving the edges clean.



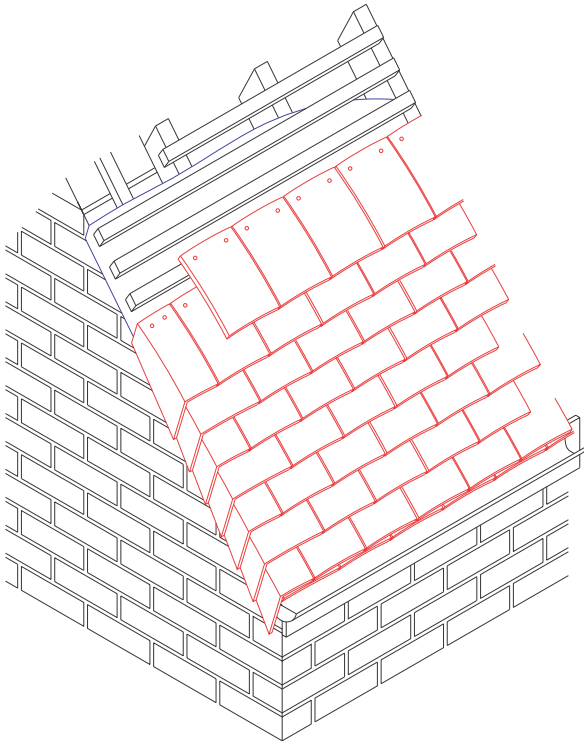

15) Cloaked verge

Carry underlay over full width of gable wall and turn down 50mm behind cloaks.
Carry tiling battens over undercloak and finish flush with verge edge.
Fix cloaked verge tiles and cloaked verge half tiles in alternate courses.

Note: Cloaked verge tiles are handed and should be specified when ordering.

Left hand verge is illustrated.

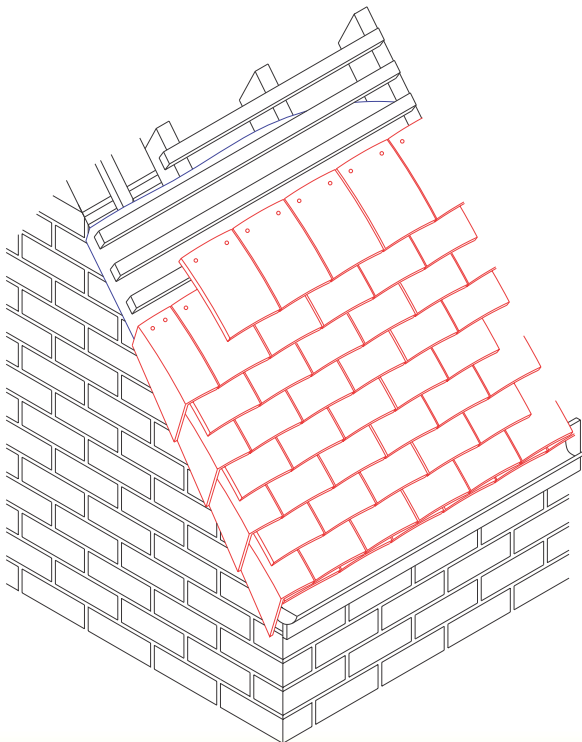

16) Cloaked verge

Carry underlay over full width of gable wall and turn down 50mm behind cloaks.
Carry tiling battens over undercloak and finish flush with verge edge.
Fix cloaked verge tiles and standard tiles in alternate courses.

Note: Cloaked verge tiles are handed and should be specified when ordering.

Left hand verge is illustrated.

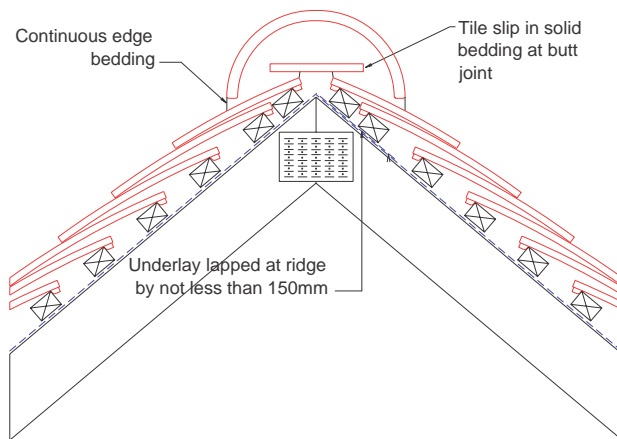

17) Bedded ridge

Lay top course of underlay from one side of ridge over apex to overlap top course at other side by not less than 150mm.

Fix finishing courses of tops tiles.

Lay ridge tiles by continuously bedding at edges and solidly bedding with tile slips inserted into mortar at joints between ridges.

Where masonry walls support or abut ridge, all ridge tiles within 900mm of such walls must be mechanically secured. Fix to supplementary ridge tile fixing batten with nails, clips or wire, etc, as recommended by manufacturer.

Fill ends of ridges at gables with mortar and slips of tiles finished flush.

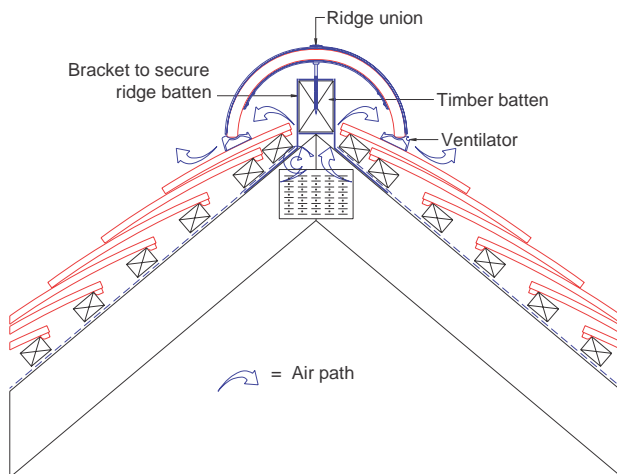

18) Dry fixed ridge

Ensure dry ridge system is compatible with particular tiles and ridges. Check with manufacturer for advice.

Terminate underlay 30mm from apex, or as recommended by manufacturer.

If required fix appropriate supplementary ridge batten.

Fix finishing courses of tops tiles maintaining specified headlap and with clearance to ridge batten. Fit dry ridge system and ridge tiles in accordance with Manufacturers Recommendations.

Use stop end or block end ridges at gables.

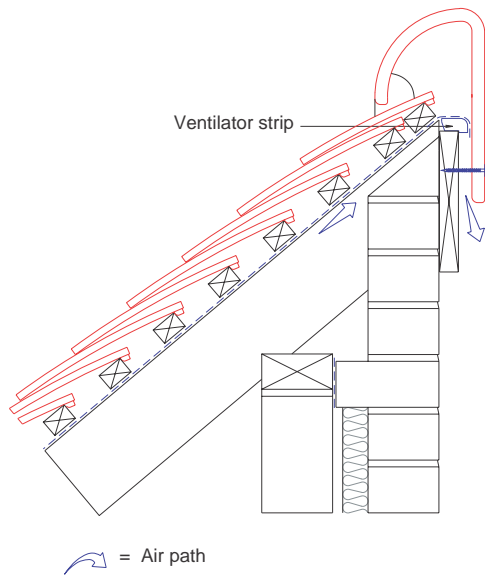

19) Bedded monopitch ridge

Carry top course of underlay over apex by not less than 150mm.

Fix finishing course of tops tiles.

Lay ridge tiles by continuously bedding at sloping edge and solidly bedding with tile slips inserted into mortar at joints between ridges.

Fix vertical face of ridge tiles to ridge fixing batten with screws or nails as recommended by manufacturer.

Fill ends of ridges at gables with mortar and slips of tiles finished flush.



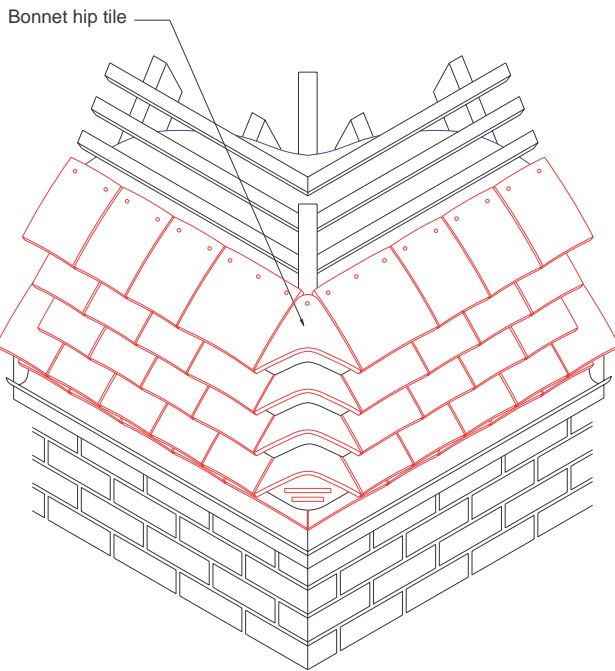

20) Hip with bonnet hip tiles

Lay courses of underlay over hip with overlaps of not less than 150mm.
 Bed bonnet hip tiles in mortar, coursing in with general tiling and fix to hip rafter with nails recommended by tile manufacturer. To avoid an excessive depth of mortar between bonnet hip tiles a supplementary hip batten should be used if necessary.
 Strike mortar back neatly about 13mm from edge of bonnet hip tile leaving the edges clean.
 Fill end of first hip tile with mortar and tile slips finished flush.
 Cut adjacent tiles and tile-and-a-half tiles to fit neatly.

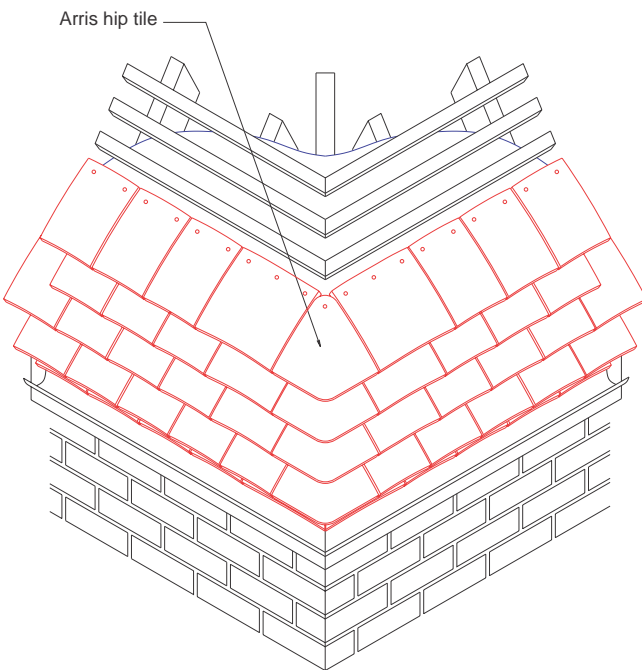

21) Hip with arris hip tiles

Lay courses of underlay over hip with overlaps of not less than 150mm.
 Spot bed arris hip tiles in mortar, coursing in with general tiling and fix to hip rafter with nails recommended by tile manufacturer.
 Cut adjacent tiles and tile-and-a-half tiles to fit neatly.

Note: Arris hip tiles are manufactured to suit specific rafter pitches, therefore the correct roof pitch must be stated when ordering.

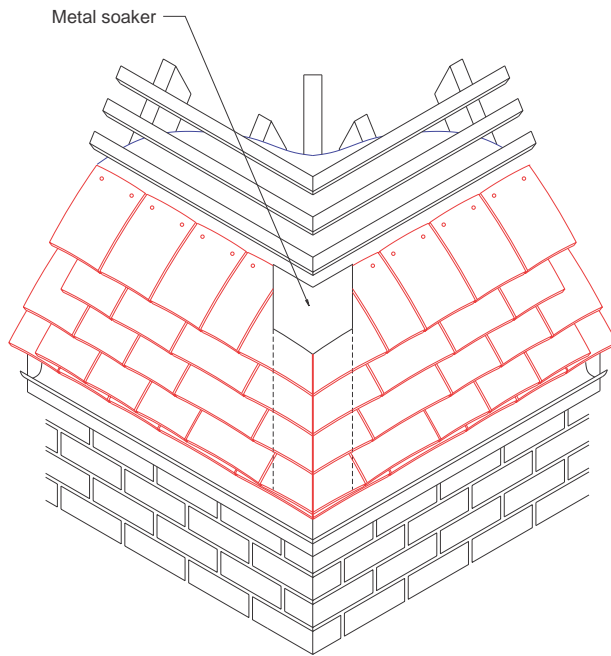

22) Mitred hip with metal soakers

Lay courses of underlay over hip with overlaps of not less than 150mm.

Cut tile-and-a-half tiles and fix to form a straight, weathertight, close mitred junction.

Interleave mitred tiles with metal soakers, extending a minimum 100mm to each side of hip. Fix soakers by turning down over heads of mitred tiles.

Note: Extreme care is needed to achieve a neat finish at the hip. Where possible it is advisable to use either bonnet hip tiles or specify specially made arris hip tiles to suit the particular roof pitch instead.

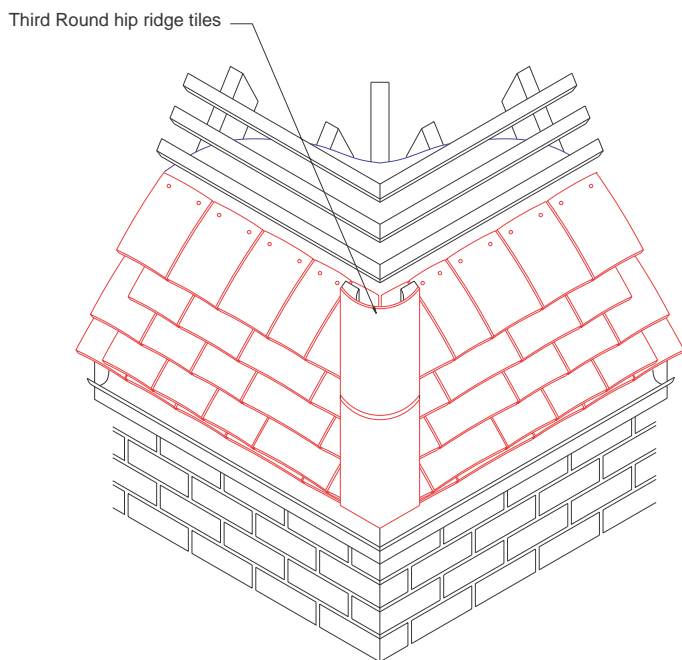

23) Bedded hip with hip ridge tiles

Lay courses of underlay over hip with overlaps of not less than 150mm.

Cut and fix tiles closely at junction.

Fix hip iron to hip rafter or hip batten with galvanised steel screws.

Lay hip tiles by continuously bedding at edges and solidly bedding with tile slips inserted into mortar at joints between hip tiles.

Where masonry walls support or abut hip, all hip tiles within 900mm of such walls must be mechanically secured. Fix to supplementary hip batten with nails, clips or wire, etc, as recommended by manufacturer.

Shape first hip tile neatly to align with corner of eaves and fill end with mortar and slips of tile finished flush.

Note: The use of ridge hip tiles should be avoided where possible in favour of the use of bonnet or arris hip tiles.

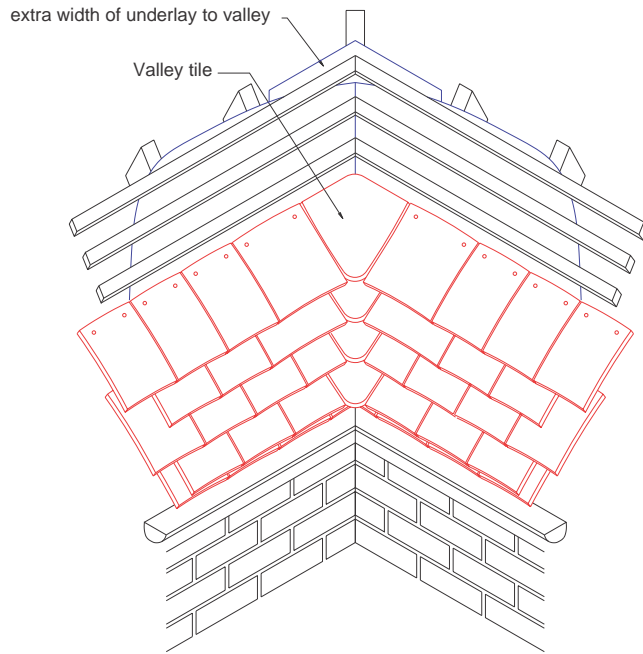

24) Valley with valley tiles

Ensure that continuous support is provided for ends of tiling battens on each side of valley.
 Cover valley with a strip of underlay not less than 600mm wide underlapping general underlay.
 Cut adjacent tiles and tile-and-a-half tiles so that valley tiles course in and fit neatly.
 Note that it is not necessary to mechanically fix the valley tiles.

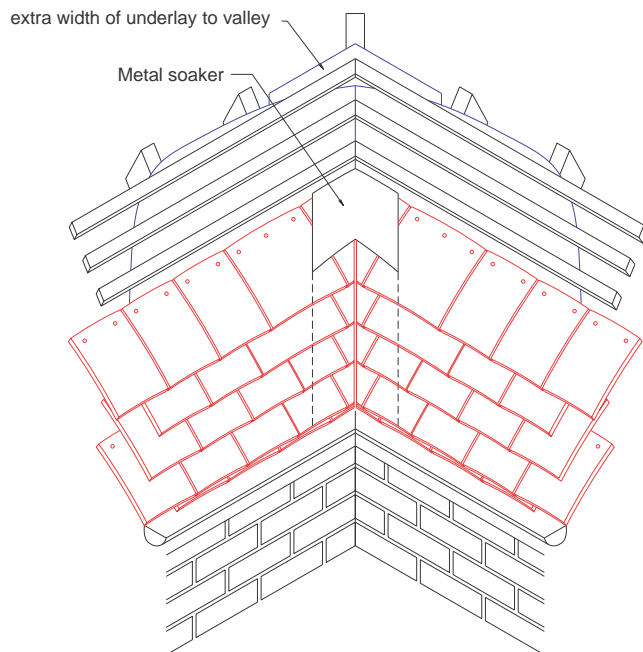

25) Valley with metal soakers

Ensure that continuous support is provided for ends of tiling battens on each side of valley.
 Cover valley with a strip of underlay not less than 600mm wide underlapping general underlay.
 Cut tile-and-a-half tiles and fix to form a straight, weathertight, close mitred junction.
 Interleave mitred tiles with metal soakers, extending a minimum 150mm to each side of valley. Fix soakers by turning down over heads of mitred tiles.

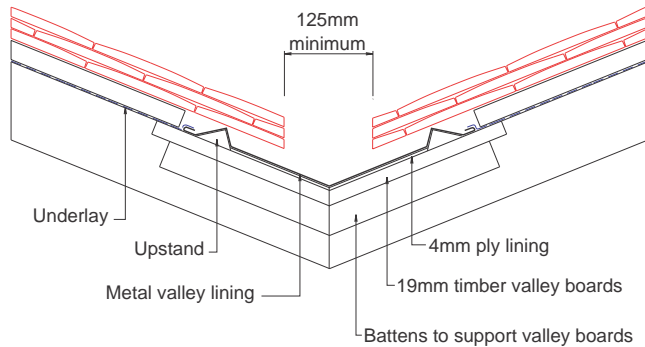

26) Valley with metal lining

Ensure that valley boards, plywood sheathing and tilting fillets provide full support for metal valley. Cut underlay to rake and dress over tilting fillets to lap onto metal valley. Ensure that underlay is not laid under metal.

Cut tile-and-a-half tiles neatly and fix to form a gap minimum 125mm wide centred on valley. Either lay tiles dry or bed on mortar onto fibre cement undercloaks laid loose on each side of valley, ensuring a minimum 25mm gap between mortar and the tilt fillet.

Note: To avoid the problems associated with open valleys the use of purpose made valley tiles should be encouraged wherever possible.

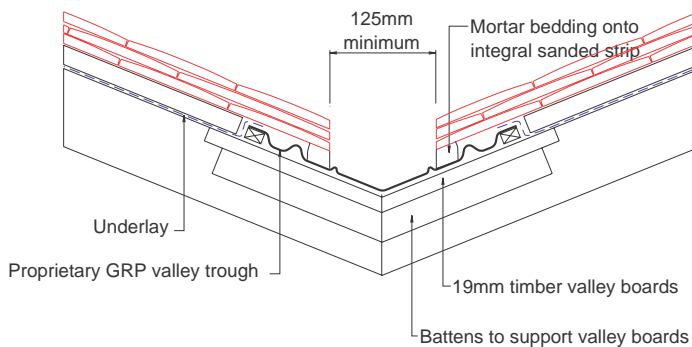

27) Valley with pre-formed GRP valley

Ensure that valley boards provide full support for GRP valley. Some types of GRP valleys do not require valley boards - check with valley manufacturer.

Lay underlay as recommended by valley manufacturer.

Fit valley as recommended by valley manufacturer. The valley should be secured to counterbattens by at least one nail every 400mm.

Cut tile-and-a-half tiles neatly and fix to form a gap minimum 125mm wide centred on valley. Either lay dry or bed on mortar onto GRP valley.

Note: To avoid the problems associated with open valleys the use of purpose made valley tiles should be encouraged wherever possible.

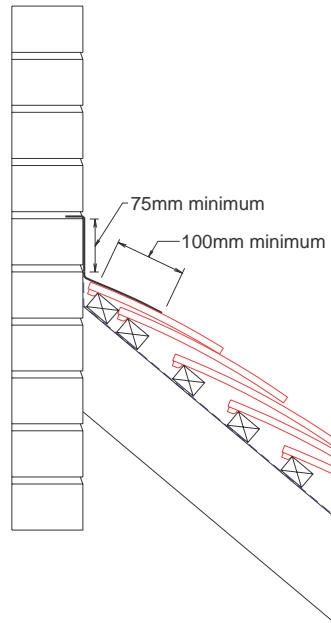

28) Top edge abutment

Turn underlay not less than 50mm up abutment.
Lay tops tiles and nail as recommended by manufacturer.

Fix tiles close to abutment to enable a weatherproof junction to be formed by metal apron flashing. Ensure metal flashing turns up abutment by minimum 75mm. The flashing should cover the tops tiles by a minimum 100mm. If tops tiles are not used then the flashing should be extended to 150mm.

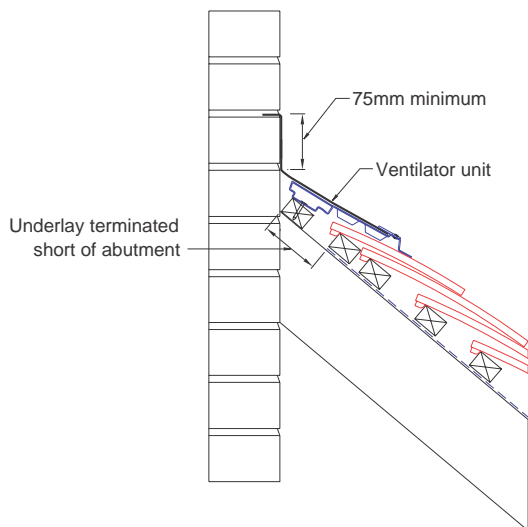

29) Ventilated top edge abutment

Ensure that an air gap is provided as recommended by ventilator manufacturer.

Lay tops tiles and nail as recommended by manufacturer.

Fix ventilator to enable a weatherproof junction to be formed by metal cover flashing.

Ensure metal flashing turns up abutment by minimum 75mm.

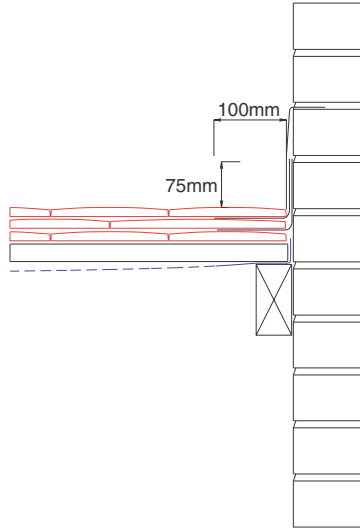

30) Side abutment with metal soakers

Turn underlay at least 100mm up abutment. Cut standard tiles and tile-and-a-half tiles as necessary and interleave with metal soakers to form a close weathertight abutment. Form soakers with a 75mm upstand against abutment and fix by turning down over the head of each tile. Dress a metal step flashing closely over the soakers with a lap of at least 65mm.



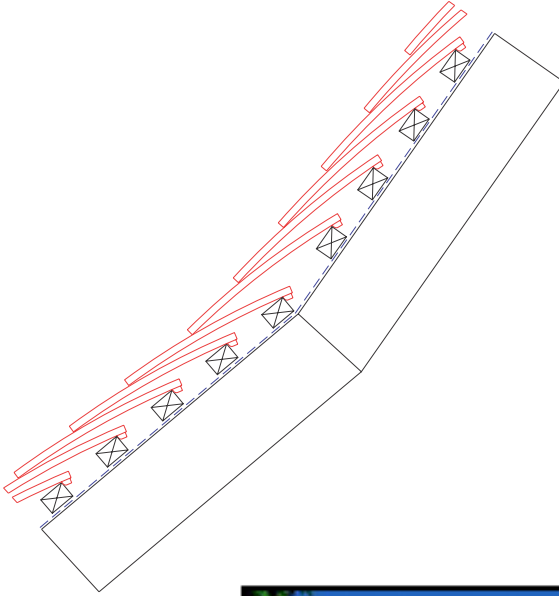

31) Change of pitch

This detail does not usually require a metal flashing when plain tiles are used. Generally, the tiling continues in the usual way and sweeps around the change in roof pitch. Care should be taken to maintain adequate headlap. Where the pitch change is significant it may be necessary to increase the batten depth (ie use a double batten) for the first course(s) at the steeper pitch.

Note: Always ensure that the lower roof is at or above the minimum recommended roof pitch for the tiles.



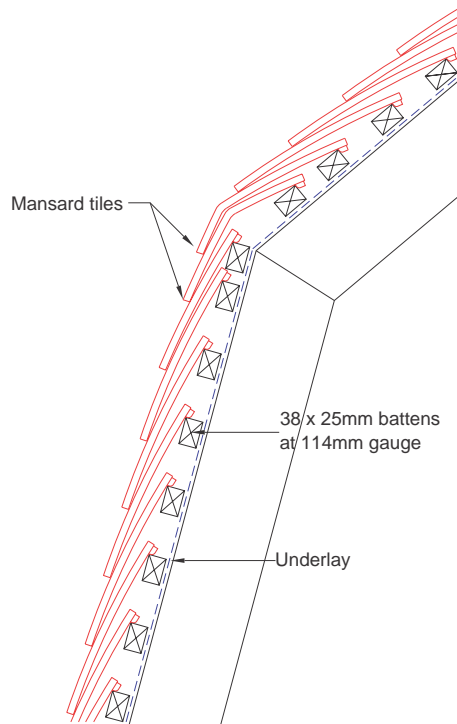

32) Mansard with mansard tiles

Ensure that a clear ventilation path is maintained from eaves to ridge where the insulation is positioned between the rafters.

Lap the roof underlay over the mansard underlay by a minimum 150mm.

Set out the tiling battens to ensure that a 65mm headlap is maintained for the mansard tiles.

Mansard tiles need to be specified for the particular roof pitches required.

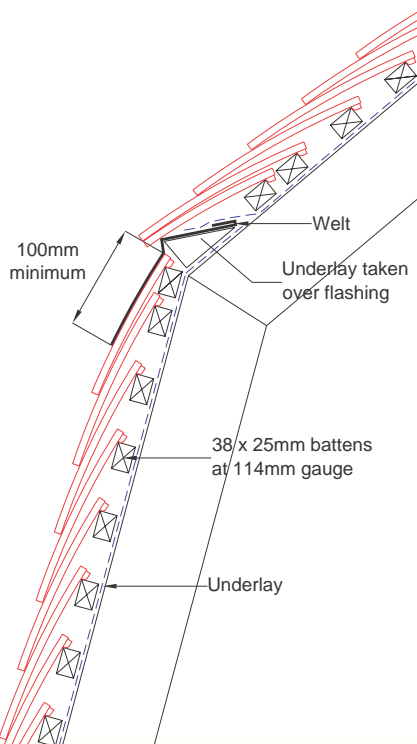

33) Mansard with metal flashing

Fix continuous timber tilt batten at eaves to provide support for metal flashing and eaves course of tiles. Ensure that a clear ventilation path is maintained from eaves to ridge where insulation is positioned between the rafters.

Lap roof underlay over metal welt and secure mansard underlay under tilt batten.

Dress cover flashing over the top course mansard tiles by minimum 100mm and extending 150 to 200mm up the tilt batten.

Clip the bottom edge of the flashing in exposed locations.

Note: The use of mansard tiles should be encouraged wherever possible.

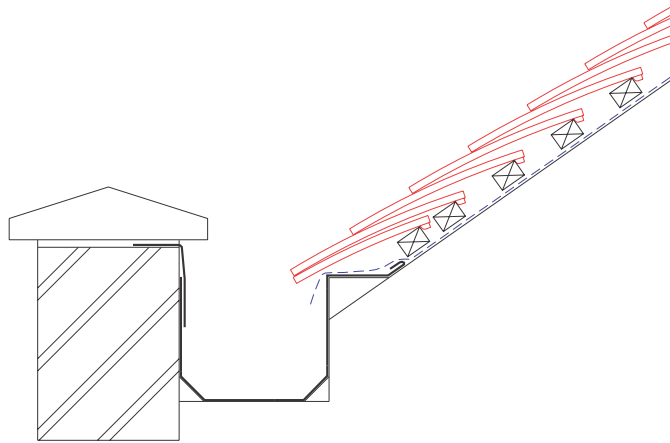

34) Box gutter eaves

Fix continuous timber tilt batten at eaves to provide support for metal flashing and eaves course of tiles. Cover metal gutter lining up over the tilt batten and extend under the eave course by minimum 150 to 200mm .

Lap roof underlay over metal welt.

Note: An over fascia ventilation strip could be positioned on top of the tilt fillet to provide low level ventilation, but air flow may be restricted, depending upon the height of the wall. Also, the designer must be satisfied that the gutter will not become blocked with debris or by freezing and cause flooding into the roof space through the ventilator. If either of these points are of concern then ventilation tiles should be provided clear of the wall and gutter instead.

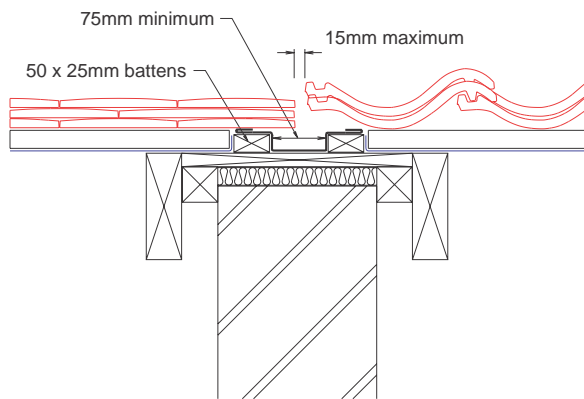

35) Bonding gutter with metal lining

Ensure that gutter board is wide enough to provide full support for ends of tile battens, tilt battens and the valley lining. Pack the void between the board and top of party wall with quilt insulation.

Turn underlay over timber tilt battens either side of bonding gutter.

Use tiles and tile-and-a-half tiles to form a gap no greater than 15mm between plain tiles and adjacent roof covering.

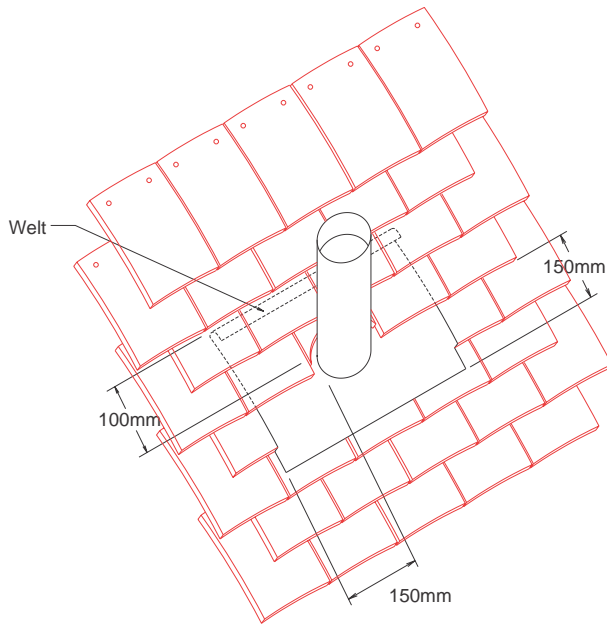

36) Pipe flashing

This detail shows a standard metal flashing for use with a 100mm diameter pipe.

The metal flashing should extend a minimum of 150mm below and to each side of the pipe and at least 100mm under the tiles above the pipe, ending in a welt.

The flashing should extend at least 150mm up the pipe, measured at the back of the pipe.

The flashing can be turned into the pipe, as shown here. Alternatively, a pipe collar can be fitted to weather the joint between flashing and pipe.

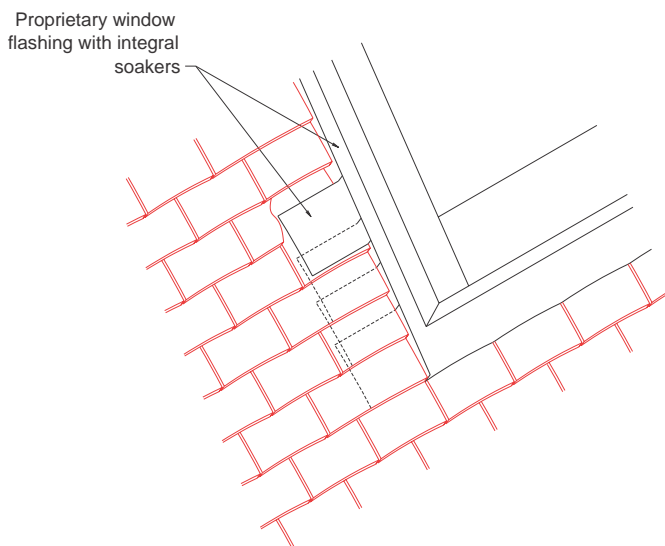

37) Roof window flashings

Roof windows can be supplied with the appropriate pre-formed flashing suitable for use with plain tiles. At the top edge the flashing forms a top or 'back' gutter.

At the bottom edge the flashing forms a cover flashing over the course of tiles below the window.

At the sides of the window integral soakers interleave with the tile courses.

(See roof window manufacturers details for specific installation details)

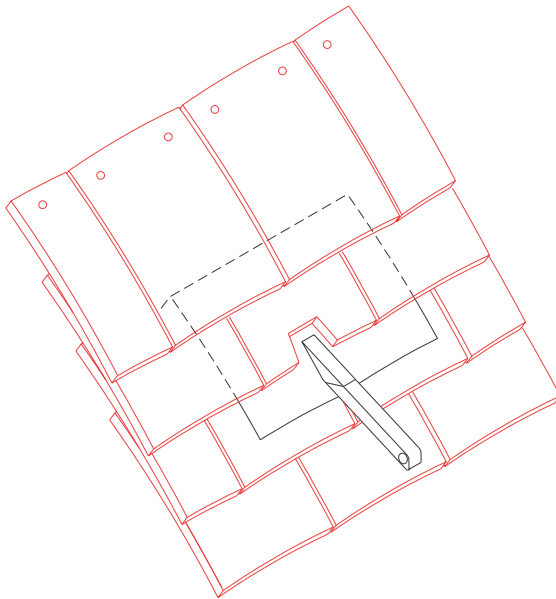

38) Safety hook fixings

Penetrations through the tiling such as pipes or safety hooks should be weathered using a suitable metal flashing.

The flashing should be turned over the top of the tiles.

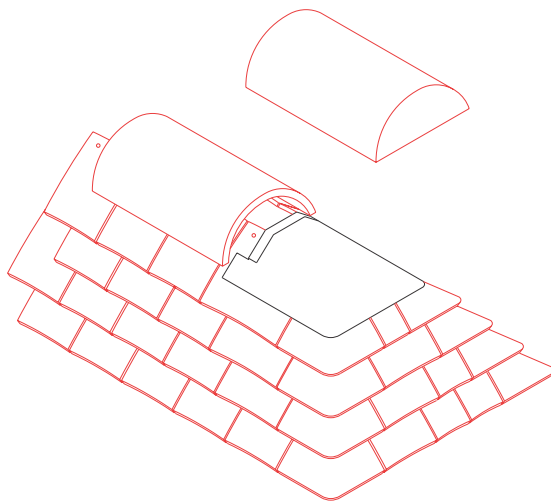

39) Metal saddle to ridge junction

Suitable metal saddles should be fitted at junctions such as between ridge and hip, ridge and valley, ridge and abutment and at the top of two valleys.

This particular drawing shows a typical saddle between ridge and hips. The saddle should extend at least 100mm over the top courses of tiles.

A special hip stop end ridge tile should be fixed over the metal saddle - not shown for clarity.

REPAIR AND MAINTENANCE

When correctly installed the finished roof should give trouble-free performance for the guaranteed life of the product.

Basic precautions

A regular visual inspection of the roof should be undertaken to ensure that tiles have not been damaged and that moss and lichen growths that could affect the flow of water off the roof are removed. Any openings or ventilation grills should be checked and cleared if blocked. Gutters should be cleared of debris and leaves.

Access to roof

Care should be taken to avoid access to the roof by window cleaners, aerial installers, etc. without adequate access equipment.

If ladders are used for temporary access to the roof, the ladders should not rest against the tiles without a suitable packing material to protect the tiles against breakage.

Mobile access platforms are suitable where the repair work is not extensive. All mobile tower platforms should be constructed to the requirements of BS 7171 : 1989 (power operated) or BS 1139 : Part 3 : 1994 and BS 1139 : Part 5 : 1990 (mobile working towers).

Scaffolds should be used where the repair work is extensive. All independently tied scaffold should conform to BS 5973 : 1993.

Repair and replacement of broken tiles

To repair damaged tiling raise the tiles with a trowel. Where the tiles are nailed carefully remove the nails using a 'slaters rip'. The damaged tiles can then be removed and replaced.

Major repairs

Where the condition of the roof of a historic building is poor enough to warrant stripping and re-tiling, it is acknowledged that English Heritage and local authority conservation officers like to see sound tiles salvaged and re-used on the same roof, with any deficiencies made up with new tiles which match the existing. Members of CRTCC are in the unique position of being able to assist in the provision of new tiles to match historic patterns and thereby ensure the success of such projects.

When recovering, it is advisable to photograph the roof prior to stripping, to ensure that the existing details are properly followed. Stripping should be carried out carefully to ensure that any sound existing tiles remain undamaged so that they can be sorted according to type, size, and thickness and stored for re-use. When assessing existing tiles for re-use, their likely further life should be carefully considered.



Retiling should be carried out using sound tiles salvaged from the roof, with any deficiencies made up with suitable replacement tiles, matching the existing ones in type, size, thickness, colour, and texture. The selection of existing tiles for reuse should be carried out with great care to ensure that they will have a significant life in relation to the new material. If the direct equivalent of the original tiles are not readily available from stock, member companies of CRTC can supply to order specially made tiles for such projects.

HEALTH AND SAFETY

The recommendations in the HSE guidance note HSG 33: 'Health and Safety in Roofwork', HSG 150 Health and Safety in Construction and the National Federation of Roofing Contractors' safe wind speed recommendations should be followed.

This section provides guidance on safety method statements, a list of legislation that may apply, risk analysis and guidance on roof access.

Safety method statement

A safety method statement should be prepared that includes :

- all working positions and access routes to and on the roof;
- how falls are to be prevented;
- how the danger from falling materials to those at work and to the public is to be controlled;
- how risks to health will be controlled;
- how other risks identified at the planning stages are to be controlled;
- what equipment will be required;
- what competence and training will be needed;
- who will supervise the job 'on-site'
- how changes will be made to the work without prejudicing safe working;
- who will monitor that the safe system of work is operating properly.

Legislation

With particular reference to roofs, the following laws could apply:

Health & Safety At Work Act (HSW) 1974	Applies to all work employers, employees, self-employed.
Management Health & Safety at Work (MHSWR) 1999	Applies to all work employers, employees, self-employed. Assess and reduce risks.
Construction (Health, Safety & Welfare) 1996	Applies to all construction work employers, employees, self-employed and all those who can contribute to the health and safety of a construction project.
Construction Regulations 1989	Applies to all requiring head protection.
Construction Design and Management (CDM) 1994	Applies to all large scale, non-domestic work.
Lifting Operations and Equipment (LOLER) 1998	Applies to all lifting equipment.
Manual Handling Operations 1992	Applies to employers and the moving of objects by hand or bodily force.
Provision and Use of Work Equipment (PUWER) 1998	Applies to all equipment providers including machinery which should be safe for work.

The Workplace (Health, Safety and Welfare) 1992	Applies to employers regarding ventilation, heating, lighting, workstations, seating and welfare facilities.
Health and Safety (First Aid) Regulations 1981	Provision of suitable first aid facilities and at least one trained first aider.
Reporting of Injuries, Diseases and Dangerous Occurrences Regulations (RIDDOR) 1995	Require employers to notify certain occupational injuries, diseases and dangerous events.
Noise at Work Regulations 1989	Require employers to take action to protect employees from hearing damage.
Electricity at Work Regulations 1989	Require people in control of electrical systems to ensure they are safe to use and maintained in a safe condition.
Control of Substances Hazardous to Health Regulations (COSHH) 1994	Require employers to assess the risks from hazardous substances and take appropriate precautions.
Personal Protective Equipment at Work 1992	Applies to employers for the provision, use and storage of appropriate protective clothing and equipment.

Risk analysis

Management of Health and Safety at Work Regulations 1999 require employers to carry out risk assessments, make arrangements to implement necessary measures, appoint competent people and arrange for appropriate information and training.

This requires:

- Looking for hazards
- Who and how they can be harmed
- Evaluate and action to eliminate or reduce risk
- Record or communicate findings
- Review findings

When looking for hazards consideration should be given to:

- ⊘ Trees
- ⊘ Overhead phone and electric cable.
- ⊘ Large eaves overhang reducing stability of access equipment.
- ⊘ Vulnerable building features such as plastic gutters and castellated ridge tiles.
- ⊘ Aerial, satellite dish and phone cables laid across roof.
- ⊘ Uneven roof rafters.
- ⊘ Doorways or others pedestrian routes below the work area.
- ⊘ Weak roof structures below work area such as conservatories.
- ⊘ Uneven or soft ground below work area.
- ⊘ Length of roof pitch to suit available roof ladders.
- ⊘ Clearance of hidden roof structure such as flashing or aprons from chimneys or valleys.
- ⊘ Features of the building enabling tie-in of access equipment such as opening windows.
- ⊘ Routes of electric extension cables avoiding risk of tripping
- ⊘ Overlooking of private areas/screening

Personal access and working at heights

A temporary platform at or near eaves level is an essential safety item when working above 2 metres height.

Working platform features:

- ⊘ Min. width to cover working area whilst on roof.
- ⊘ Sufficient strength to support loads including personnel, tools and materials.
- ⊘ Sufficient integrity to stop tools and debris falling below.
- ⊘ Main guardrail min. 910mm. above fall edge.
- ⊘ Toe-board min. 150mm. high.
- ⊘ No unprotected gap between these exceeding 470mm. (i.e. Use mesh or intermediate rail)

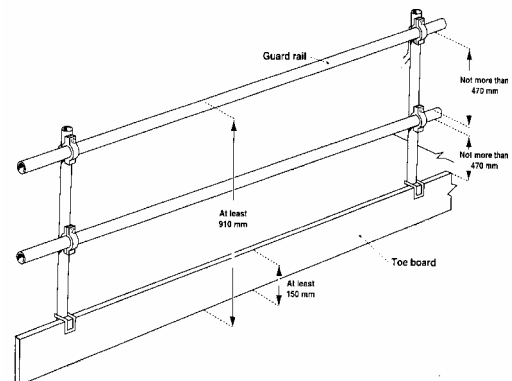

The working platform is typically supported by one the three illustrated methods.

Mobile aluminium access tower (MAT)

Requires trained, technical knowledgeable or experienced installer and user. Inspection report not mandatory where sited for less than 7 days. Modifications only possible with manufacturer's acknowledgment. Not normally capable of supporting hoist or gin wheel. Requires internal ladder access.

Should meet PASMA guidelines.

Light structure with compact components.

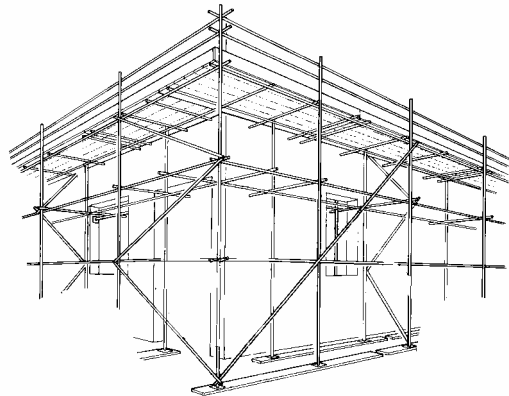
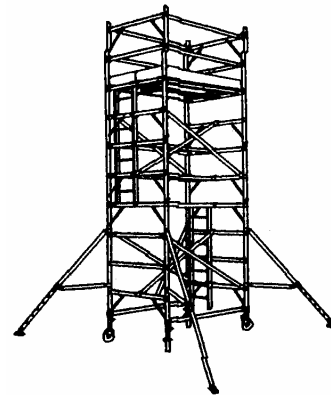

General Steel Scaffolding

Requires trained, technical knowledgeable or experienced installer to provide mandatory inspection report. Usually already in place in during new build. Can support hoist or gin wheel for lifting collector. Can be customised to building shape. Can support external ladder. Should meet NASC guidelines. Heavy structure with long components.

Mobile elevated platform (MEP)

Requires trained, technical knowledgeable or experienced installer and user. Inspection report not mandatory where sited for less than 7 days. Modifications only possible with manufacturer's acknowledgement. Possibility of supporting hoist or gin wheel. Light structure with compact components.

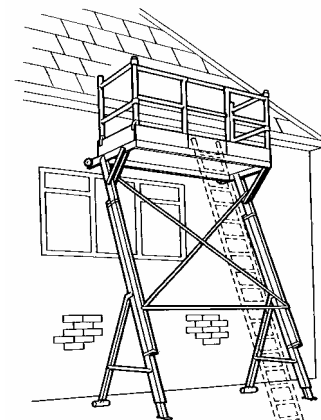

In all cases the structure should either be tied into the building (through ties, reveal ties or eyebolts) or stabilised with diagonal/raked supports down to ground. To permit personal access stepping off the working platform onto a roof, one side of the working platform guardrails can be removed providing any hazardous gap between the platform and wall is considered and special guardrail extensions are placed protruding over the roof.

Although there is now a large selection of mobile access equipment (MEWPs) for creating a temporary working platforms, to date none have been identified which permit a side of guardrail to be dropped for roof access to enable personnel to safely leave the platform with tools or materials. To also note, any work within 2 metres of a gable end requires gable edge protection.

The only recommended use of a ladder is for personal access and short-term work (i.e. within minutes). In this context the ladder should extend at least 1 metre above the landing place and be tied-in to the building to prevent sideslip top and bottom. Forthcoming EU Directive 89/655/EEC is likely to require ladder work at height only where other safer work equipment is not justified in view of the short duration of use and low level of risk.

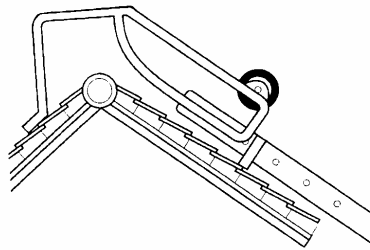

A roof ladder should be used to supplement edge protection on pitched roofs and provide additional support for work. They also reduce damage to the roof coverings. The ladder should be secured against accidental movement and the anchorage should not rely on the ridge capping or typical gutters. Using a ridge iron on the opposing pitch and tying onto the eaves platform support is typical. On long, steep pitches where work is near the ridge, an extra platform or

safety harness may be required to reduce injury upon hitting the eaves platform in the event of a fall. All weight loading calculations should consider a minimum of two workers plus tools and materials.

Roof accessories are available which improve installation and future access. These include permanent metal steps and opening skylights that replace roof tiles in the area they are located. These may require a minimum batten size. Consideration can always be given to temporary removal of tiles to allow better footing during installation.



MATERIAL SPECIFICATIONS

Tiles and fittings

Plain clay tiles and fittings should comply with BS EN 1304.

Accessories

Accessories, e.g. ventilation tiles, proprietary soakers, outlets, edge trims, proprietary flashings etc., should have third party approval for the design, installation and performance.

Lead

Where lead is exposed to weathering it should be, as a minimum, code 4, BS 1178, and where it is protected it may be code 3. Surfaces of all exposed lead should be treated with patination oil to prevent lead oxide staining of the tiles.

Mortar

Where mortar is used as a filler a mix of 1 : 4; cement : sand, would be satisfactory, but, where the mortar is used to fix hips and ridges, a mix of 1 : 3; cement : sand, should be used. A test method for measuring the tensile bond strength of the mortar is given in BS 5534. Specific lime mortars may be required for Listed buildings.

Underlays

Fully supported

This includes roofing underlays laid directly onto the boarding or sarking. The roofing underlay should be of adequate strength, water resistance and durability with water vapour transmission high enough to prevent the formation of condensation beneath the underlay. A test carried out in accordance with BS 7374 is recommended with a minimum permeability of 0.36 g / m² per 24hr at 25°C and relative humidity of 75%. The method of assessment given in BS 5250 should be used to ensure that harmful condensation will not develop. If necessary, to overcome potential condensation risks, a vapour control layer should be incorporated within the structure.

Unsupported

This includes roofing underlays which are draped over the rafters or underlays laid over counter-battens on boarding or sarking. Roofing underlay should be of adequate water resistance and of tensile and nail-tear strength, low extensibility under the roof environment to produce the required resistance to wind uplift. It should conform to the requirements for type 1F or 5U given in BS 747.

Flexible underlays

Underlays that meet the requirements of BS 747 or which have an UKAS-accredited-third-party-approved product certificate for their use in UK conditions should be used. European Standard, EN 13859 part 1 includes the scope of BS 747 and materials not covered by BS 747.

Rigid underlays

Products that have an UKAS-accredited-third-party-approved product certificate for their use in UK conditions should be used. A European Standard is being prepared for these products. When the European Standard is published products complying with the Standard should be used. Products, which fall outside the scope of the proposed European Standard, can be used provided they have an UKAS-accredited-third-party-approved product certificate for their use in UK conditions.

Battens and counter battens

Timber species

The timber species should comply with type A or type B as specified in BS 5534 and should be treated where the Building Regulations and bye-laws require protection against the House Longhorn beetle. Suitable treatments are given in BS 5268 : part 5.

Note : Where there is a risk that timber moisture content will be greater than 22%, treatments that react with metal fixings should be avoided, e.g., copper chrome arsenate which reacts with aluminium.

Batten and counter batten sizes

Up to 600mm support centres the :

counter batten sizes should be 38mm by 25mm minimum;
batten sizes should be 38 (+3 / -3)mm by 25 (+ 3 /-0)mm.

Fasteners

Nails for tiles

Clout head nails of diameter 3.35mm and 2.65mm may be used and they should be a minimum of 38mm long. Clout head nails complying with BS 1202 part 1 (stainless steel), part 2 (copper), part 3 (aluminium) may be used.

Steel, or, galvanised nails should not be used for nailing tiles.

Improved nails (annular, ring shank and drive screws) or screws may be used where the wind load calculation indicates that smooth shank nails will not meet the requirement.

Fasteners for fittings

Hip irons are hooks that fix to the lower end of the hip rafter and provide mechanical security for the hip tiles.

The ridge tiles that are within 900mm of a gable or an abutment should be mechanically fixed. Suitable ridge tiles with wire fixing or lugs beneath tile ridge or with a proprietary dry fixing method should be used.

Nails and fasteners for securing battens to counter battens

Round wire nails complying with BS 1202 part 1, part 7 or hot dipped galvanised or stainless steel should be used. The nails are usually 2.65mm, or, 3.55mm in diameter and 65mm long, however, they may be longer to meet the requirements for wind loading.

For exposed conditions improved nails, screws or helical fixings may be required.

Flashing and junctions

Where required, metal flashing and junctions should be fixed with copper or stainless steel nails. The size of the nails should be in accordance with the recommendations given in the Lead Sheet Manual, volume 1. Aluminium nails must not be used to fix lead flashing.

Flashing in exposed locations may need to be clipped and this should be in accordance with Lead Sheet Manual recommendations.

WIND UPLIFT CALCULATIONS

BS 5534: Part 1: 2003: The British Standard Code of Practice for Slating and Tiling, recommends the following for plain tiles with nibs:

Where nailed, plain tiles should have minimum fixings in accordance with the following:

For rafter pitches below 60 degrees, two nails should be used in each tile in at least every fifth course. For pitches of 60 degrees and above, two nails should be used in every tile.

At verges and abutments and at each side of valleys and hips, the end tile in every course should be nailed or otherwise mechanically fixed.

At eaves and top edges, two courses of tiles should be nailed or otherwise mechanically fixed.

Nails should not be less than 2.65mm in diameter and of a length which gives at least 15mm penetration into the batten. (The CRTC recommend that nails of 3.35 diameter should be used).

However it must be stressed that there will be situations where fixing the tiles at the minimum requirement may not be enough to prevent tiles being dislodged in high winds.

The following calculations can be used to establish whether a higher level of fixing is required.

Note: The calculation must not be used to justify using a lower level of fixing than the minimum recommended in BS 5534.

The following sections, A and B, show how the predicted wind uplift force for a particular project and its location can be determined.

The calculations in section C provide the resistance to the wind force and the comparison of uplift force to resistance is given in section D.

Section E gives examples of the calculations.

A Basic wind uplift equation

It is assumed that the force the wind could exert directly on the windward side of the building will act as a vacuum force on the lee side of the building and it is this vacuum that causes the tiles to lift off the roof. Therefore, it is taken that the uplift force is equal to the force applied to the windward side of the building and conventionally this is given a negative sign.

Force = Pressure x Area

Uplift force (F_t) = dynamic pressure of wind (q_s) x pressure coefficient ($C_{pe} - C_{pi}$) x area (A_t)

The dynamic pressure of the wind is proportional to the wind speed and the pressure coefficient converts the wind speed to a pressure and this takes into consideration the external and internal pressures on the roof. The coefficients have been derived from wind tunnel testing where wind speed and pressure generated were measured.

C_{pe} is the external pressure coefficient

C_{pi} is the internal pressure coefficient

Therefore,

$$F_t = q_s (C_{pe} - C_{pi}) A_t$$

Where,

$$q_s = 0.613 V_e^2$$

and,

0.613 is an experimentally determined constant and V_e is the effective wind velocity

where, $V_e = V_b \cdot S_a \cdot S_b \cdot S_d \cdot S_s \cdot S_p$

and,

V_b is the site wind speed which is obtained from the 50 year return wind speed map of the UK (given in BS 6399 and BS 5534).

S_a is a factor that takes the altitude into consideration and,

where the topography is not significant, $S_a = 1 + \Delta_s$, and

where the topography is significant, $S_a = 1 + \Delta_s$, or, $1 + 0.001 \Delta_T + 1.2 - S$,
and the greater value is taken.

Δ_s is the site altitude

Δ_T is the base altitude of the topographical feature

is the slope

S is a factor that allows for the position of the building on the slope

NOTE: Significant topography, and the calculation methods for Δ_T , and S are described in BS 6399.

S_b is a factor that takes into consideration the effective height of the building, whether the building is in a town or country environment and the distance from the sea or large open expanse of water. The method of establishing the effective height and the related values of S_b are given in BS 6399.

S_d is a wind direction factor and usually given the value 1 which allows for wind from all directions. A lower figure can be entered if there is a single or predominant wind direction.

S_s is a wind season factor which is usually set at the value 1 which allows for wind at all times of the year. A lower figure can be used if there is a significant variation in the wind loads in the different seasons.

S_p is a probability factor which is assumed to be 1 if the expected wind return rate is once in fifty years. Other figures can be used if different return periods are anticipated.

C_{p_e} is the external pressure coefficient and values can be obtained from BS 6399.

C_{p_i} is the internal pressure coefficient and the values can be obtained from BS 6399.

A_t is the exposed area of the tile and is usually calculated from the product of the batten gauge (G_a) the cover width (B) of the tiles.

Therefore,

$$F_t = 0.613 [V_b \cdot S_a \cdot S_b \cdot S_d \cdot S_s \cdot S_p]^2 (C_{p_e} - C_{p_i}) A_t$$

B Modifications to calculation method introduced by BS 5534

1. The $C_{p_e} - C_{p_i}$ is replaced by C_{p_t} which can be used for most common applications and when the values of C_{p_t} were calculated from BS 6399 they were modified to ensure that the values obtained were consistent with the values obtained from the previous CP3 standard.
2. A factor D was introduced to allow for the air permeability of the tiles.
3. An S factor was introduced to allow for the shielding effect of the underfelt, when used.
4. The uplift force equation including the BS 5534 modifications is:

$$F_t = 0.613 [V_b \cdot S_a \cdot S_b \cdot S_d \cdot S_s \cdot S_p]^2 \cdot C_{p_t} \cdot (B \cdot G_a) \cdot D \cdot S$$

C Calculation of resistance to uplift (F_c)

Two actions resist the wind uplift force; the dead weight of the tiles and the resistance of the any fixing (nails, clips, mortar etc.).

1. The dead weight of the tile

The weight of the tile must be converted to a force and component of the gravity force acting on the tile vertical to its face must be calculated.

The following equation can be used :

$$W = Wg \times 0.9 \times 9.81 \times \cos(\text{rafter pitch} - \text{tile to rafter pitch})$$

where,

W resisting force acting vertical to surface of tile due to self weight in Newtons

Wg is the conventional weight of the tile in kilograms

0.9 is a safety factor to take into consideration variations in the weights of the tiles

9.81 is factor to convert kilograms weight to Newtons

$\cos(\text{rafter pitch} - \text{tile-to-rafter-pitch})$ corrects gravity for to give the component acting vertical to the surface of the tile.

2. Fixing resistance

Information on nail resistance and mortar strength is provided in BS 5268 and BS 5534.

The resistance of nails is given in Newtons per mm of penetration of type of wood used. Mortar strengths are given in Newtons per mm² for the type of mortar mix used. The total resistance is calculated taking into consideration the nail penetration or the area of mortar contact.

D Comparison of uplift force with resistance

The moments of the forces are compared. The action of the forces needs to be considered to identify the fulcrum points and the length of the lever arms through which the forces act.

Thus the uplift force is taken to act at the central point of the exposed part of the tile and through a lever arm that rotates round the corner of the batten and the tile nib. The self weight is taken to act through the centre of gravity of the tile and the lever again rotates round the batten and the tile nib. The lever arm for the nail resistance is the distance from the point where the nail penetrates the batten and the batten tile nib contact rotation point.

Normal practice is to make a number of trial calculations with different fixing patterns until values that exceed the uplift force are achieved.

E Calculation examples

1. Uplift force calculation

Plain tiles (Town Site)

Assume :

Duo-pitched roof, general and local areas, 40° rafter pitch, Newcastle area, town position and no buildings with 45 m, 2 kilometres from the sea, 30 m above sea level, no significant topographical features and 7.5 m to ridge.

$$F_t = 0.613 [V_b \cdot S_a \cdot S_b \cdot S_d \cdot S_s \cdot S_p]^2 \cdot C_{pt} \cdot (B \cdot G_a) \cdot D \cdot S$$

V_b	24 m / s	BS 6399 figure 6	
S_a	1.03	$1 + 0.001 \Delta_s$	where Δ_s is height of site above sea level
S_b	1.615	BS 6399 table 4	$H_e = 7.5$ m; 2 km from sea; town position; no significant topographical features
S_d	1	BS 6399 2.2.2.3	
S_s	1	BS 6399 2.2.2.4	
S_p	1	BS 6399 2.2.2.5	
C_{pt}	-0.11	BS 5534 table 8	general area
	-0.13	BS 5534 table 8	local area
B	0.165 m		width of tile in metres
G_a	0.1 m		gauge in metres
D	2.70	BS 5534 table 9	air permeability factor
S	1	BS 5534 table 10	underfelt shielding factor

When the values given above are substituted in the basic equation the following values are obtained:

$$F_t = -4.78 \text{ N} \quad \text{general area}$$

$$F_t = -5.658 \text{ N} \quad \text{local area}$$

Plain tiles (Country Site)

Assume :

Duo-pitched roof, general and local areas, 40° rafter pitch, Newcastle area, country position and no buildings with 45 m, 2 kilometres from the sea, 100 m above sea level, no significant topographical features and 7.5 m to ridge.

$$F_t = 0.613 [V_b \cdot S_a \cdot S_b \cdot S_d \cdot S_s \cdot S_p]^2 \cdot C_{pt} \cdot (B \cdot G_a) \cdot D \cdot S$$

V_b	24 m / s	BS 6399 figure 6	
S_a	1.10	$1 + 0.001 \Delta_s$	where Δ_s is height of site above sea level
S_b	1.7	BS 6399 table 4	$H_e = 7.5$ m; 2 km from sea; country position; no significant topographical features
S_d	1	BS 6399 2.2.2.3	
S_s	1	BS 6399 2.2.2.4	
S_p	1	BS 6399 2.2.2.5	

C_{pt}	-0.11	BS 5534 table 8	general area
	-0.13	BS 5534 table 8	local area
B	0.165 m		width of tile in metres
G_a	0.1 m		gauge in metres
D	2.70	BS 5534 table 9	air permeability factor
S	1	BS 5534 table 10	underfelt shielding factor

When the values given above are substituted in the basic equation the following values are obtained:

$$F_t = -6.051 \text{ N} \quad \text{general area}$$

$$F_t = -7.15 \text{ N} \quad \text{local area}$$

Plain tiles (Country Site; Significant Topography)

Assume :

Duo-pitched roof, general and local areas, 40° rafter pitch, Newcastle area, town position and no buildings with 45 m, 10 kilometres from the sea, base 30 m above sea level, hill (slope 0.3 100m base length and site 30 m windward side of ridge, and building height 7.5 m to ridge.

$$F_t = 0.613 [V_b \cdot S_a \cdot S_b \cdot S_d \cdot S_s \cdot S_p]^2 \cdot C_{pt} \cdot (B \cdot G_a) \cdot D \cdot S$$

V_b	24 m / s	BS 6399 figure 6	
S_a	1.1765	$1 + 0.001 \Delta_t + 1.2 e_s$	
		$\Delta_t = 30 \text{ m}$, where Δ_t is base height of site above sea level BS 6399	
		2.2.2.2.3	
		$e_s = 0.3$, where e_s is effective slope of the topographical feature BS 6399	
		2.2.2.2.3	
		$S = 0.407$, where S is the topographical location factor BS 6399 2.2.2.2.3 & amendment table G2	
S_b	1.615	BS 6399 table 4	$H_e = 7.5 \text{ m}$; 2 km from sea; town position; no significant topographical features
S_d	1	BS 6399 2.2.2.3	
S_s	1	BS 6399 2.2.2.4	
S_p	1	BS 6399 2.2.2.5	
C_{pt}	-0.11	BS 5534 table 8	general area
	-0.13	BS 5534 table 8	local area
B	0.165 m		width of tile in metres
G_a	0.1 m		gauge in metres
D	2.70	BS 5534 table 9	air permeability factor
S	1	BS 5534 table 10	underfelt shielding factor

When the values given above are substituted in the basic equation the following values are obtained:

$$F_t = -6.52 \text{ N} \quad \text{general area}$$

$$F_t = -7.71 \text{ N} \quad \text{local area}$$

2 Calculation of uplift resistance

Self weight

Weight of plain tile 1.2kg

Force component perpendicular to tile surface :

$$W = 1.2 \times 0.9 \times 9.81 \times \cos (40 - 10) \text{ N}$$

$$= 9.17 \text{ N}$$

Nail resistance

Assume :

A 2.65mm diameter nail with a type A batten has a resistance of 1.5 N per mm of penetration (BS 5268 part 2)

BS 5534 3.6.3.4.2.(b) recommends a factor of 3 is applied to this value.

Nail penetration is assumed to be 17mm

Therefore:

$$\text{nail resistance} = 17 \times 1.5 \times 3 = 76.4 \text{ N, and,}$$

for two nails the value is 153 N.

The following factor (K_n) may be used to reduce the resistance to where some courses are not nailed.

Where, n = 1	$K_n = 1$	all courses nailed
n = 2	$K_n = 0.379$	every 2nd course nailed
n = 3	$K_n = 0.184$	every 3rd course nailed
n = 4	$K_n = 0.102$	every 4th course nailed
n = 5	$K_n = 0.058$	every 5th course nailed

The K_n factors have been calculated using the equation given in BS 5534 3.6.3.4.2

3 Comparison of uplift and resistance moments

Uplift moments

The uplift moment M_u is given by $F_t \times L_f$, where L_f is the lever arm from the batten nib rotation point to the centre of the exposed area of the tile.

Example 1

$M_u = F_t \times L_f$	= -4.78 x 0.2	= -0.956 Nm	general area
	= -5.658 x 0.2	= -1.1316 Nm	local area

Example 2

$M_u = F_t \times L_f$	= -6.051 x 0.2	= -1.2102 Nm	general area
	= -7.15 x 0.2	= -1.43 Nm	local area

Example 3

$M_u = F_t \times L_f$	= -6.52 x 0.2	= -1.304 Nm	general area
	= -7.71 x 0.2	= -1.542 Nm	local area

Self weight moment

M_w is the restoring moment due to self weight and is given by :

$$M_w = F_w \times L_w = 9.17 \times 0.12 = 1.10 \text{ Nm}$$

The residual uplift forces after the self weight moment is subtracted are

Example 1

M_u	= -0.0 Nm	general area
	= -0.0316 Nm	local area

Example 2

M_u	= -0.1102 Nm	general area
	= -0.33 Nm	local area

Example 3

M_u	= -0.204 Nm	general area
	= -0.442 Nm	local area

1st comparison

When the uplift moments are compared to the restoring moment due to self weight it can be seen that the self weight only exceeds the requirement in the general area of the first example and that in all other cases nailing will be required.

Nail resistance moments

M_n is the restoring moment due to the nail resistance and is given by :

$$M_n = F_n \times L_n = 153 \times 0.013 = 1.989 \text{ Nm} \quad \text{twice nailed tiles}$$

Applying the reduction factors for unnailed courses the following values are obtained

$n = 1$	K_n	$= 1.989 \text{ Nm}$
$n = 2$	K_n	$= 0.754 \text{ Nm}$
$n = 3$	K_n	$= 0.370 \text{ Nm}$
$n = 4$	K_n	$= 0.238 \text{ Nm}$
$n = 5$	K_n	$= 0.115 \text{ Nm}$

2nd Comparison

When the residual uplift moments are compared with the nail resistance values a nailing specification that exceeds the residual value would be considered safe for that site.

Appendix C: References & bibliography

Slate & tile roofs: avoiding damage from aircraft wake vortices - Dr Paul Blackmore-2002

Methods of Mounting Solar Thermal - The Solar Design Company-2002

Collectors on UK Roofs

Rolled Lead Sheet - The Complete Manual - The Lead Sheet Association-2003

The Plain Tile in English Architecture - Dr R W Bruskill-October 1985

BS 1139 part 3

BS 1178

BS 1202 part 1

BS 1202 part 2

BS 1202 part 3

BS 1202 part 7

BS 1304

BS 5250

BS 5534

BS 5973

BS 6399

BS 7171

BS 7374

BS 747

BS 8000 part 6

EU Directive 89 / 655 / EEC - 1989

prEN 13859 part 1

HSG 150

Health and Safety in
Construction

HSE

HSG 33

Health and Safety in
Roofing