



THINKING PRECAST?
THINK FP MCCANN



DRAINAGE AND WATER MANAGEMENT

v3.9

**CONCRETE
PIPES**



**EASI-BASE™
MANHOLE
SYSTEM**

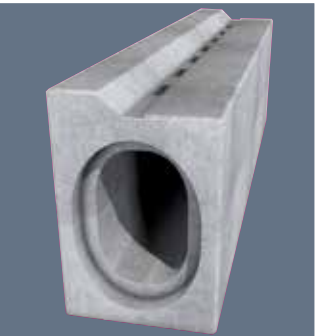

**STORM-
CHANNEL™**
HEAVY DUTY PRECAST
DRAINAGE CHANNEL



**STORM-
BRAKE™**
VORTEX FLOW CONTROL
CHAMBER UNIT



**STORM-
STORE™**
TANK & CHAMBER
SYSTEMS



**STORM-
HOLD™**
STORM WATER
MANAGEMENT SYSTEM





DRAINAGE AND WATER MANAGEMENT

With one of the largest drainage and water management product ranges in the UK and Ireland, FP McCann has become the first choice for all of our customers.



8 good reasons why you should use Concrete Drainage	6	DN1050 Highways Agency Catchpit	34
Spigot & Socket Pipes	8	Catchpit	35
Oblique Tumbling Junction	10	Valve Chamber	36
Square Tumbling Junction	11	StormBrake™ - Vortex Flow Control Unit	37
Pipe Handling/Laying Instructions	12	StormCleanser™ - Hydrodynamic Separator	40
Anchor System	13	StormChannel™ - Heavy Duty Precast Drainage Channel	42
Pipe Lifting Instructions	14	House Inspection Chambers	43
One Piece Integral Rubber Seal	15	Gullies and Slabs Range	44
Air Test Only (A.T.O.) - Inflatable Pipe Stopper	15	Fall Arrest System	45
Pre-Lubricated Pipes	16	Rain Harvesting Chambers	46
Manhole Chambers	17	Add-A-Step® Modular Ladder System	47
Recommended Site Work Practice	18	Plastic Encapsulated Ladders & Rungs	48
Manhole Soakaways	18	Handhold Entry Pole System	49
DN4000 Manhole Chamber	19	Headwalls	50
Wide Wall Manhole Chamber	20	Mechanical Concrete Pipe Lifter	52
Manhole Cover Slabs & Accessories	22	Know Your Lifters	53
Adjusting Units & Corbel Slabs	23	StormStore™ Range of Tanks & Chamber Systems	55
Manhole Construction	24	Parametric Design	56
Easi-Base™ DN1200	25	StormChamber™ - Multipurpose Chamber System	57
Easi-Base™ Order Form	27	StormTank™ - Multipurpose Panel System	58
Easi-Base™ DN1500-2100	28	Modular Tank System	59
Easi-Base™ Weights & Lifting Mechanism Detail	29	StormHold™ - Storm Water Management System	62
Easi-Base™ Integral Seal	30	Dry Weather Flow Channels	65
Flexi-Fit Pipe Seal	31	Box Culverts & Portal Frames	67

OUR COMPANY

KEY

- ◆ Drainage Facilities
- Other Manufacturing Facilities
- ▲ Quarries / Manufacturing Locations

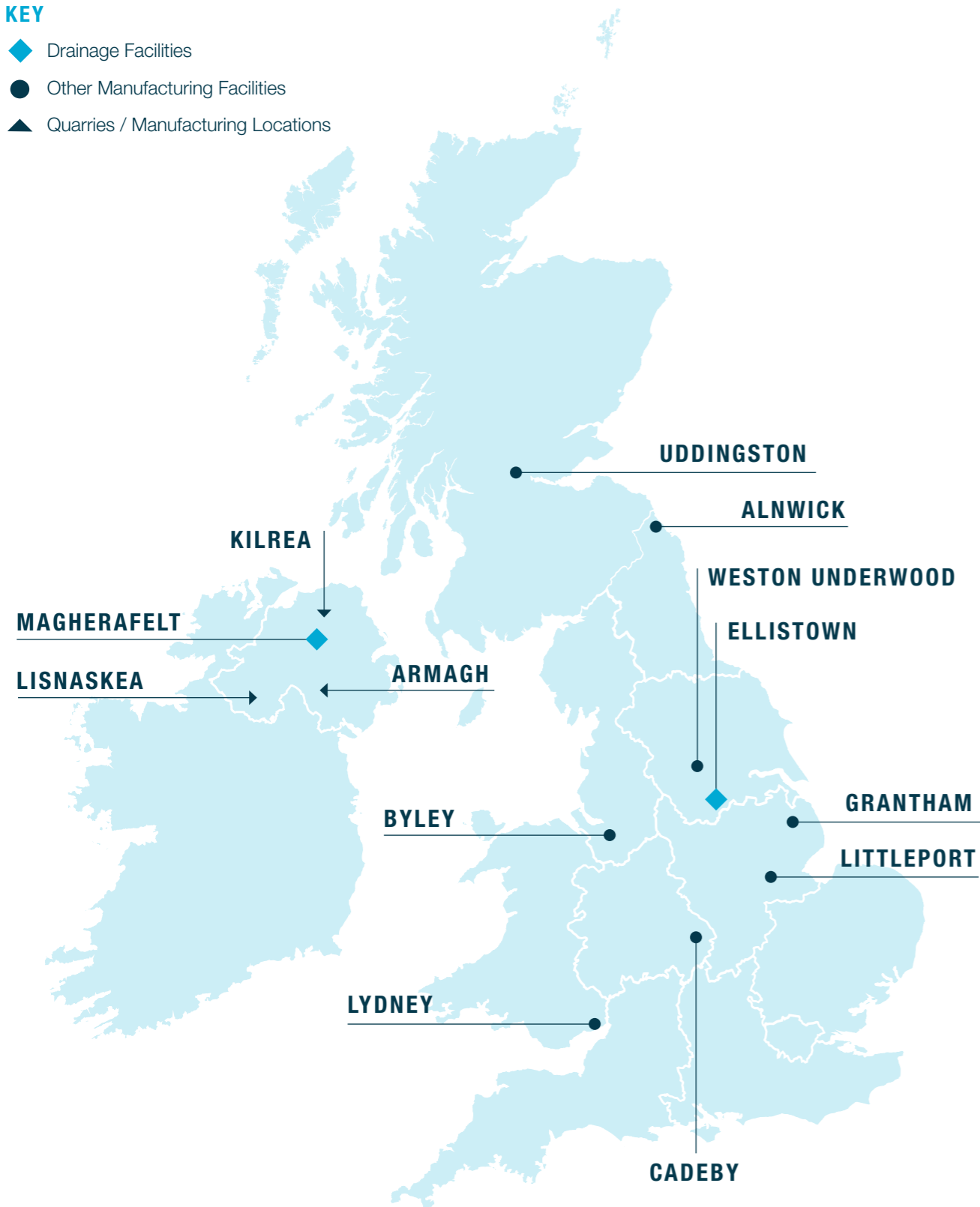

OUR COMPANY

FP McCann is the UK's market leader in the manufacture, supply and delivery of precast concrete solutions. Our comprehensive precast concrete business extends to include:

**AGRICULTURE | BOX CULVERTS | BUILDING PRODUCTS | CONCRETE ROOF TILES
DOCK LEVELLER PITS | DRAINAGE | FENCING | FILTER BED SYSTEMS
FLOORING | POWER & INFRASTRUCTURE | PRECAST OFF-SITE BUILDING SOLUTIONS
RAIL | SPECIALIST PRECAST | TANKS & CHAMBERS | TUNNELS & SHAFTS | WALLING**

Modern manufacturing plants at Alnwick (Northumberland), Armagh (Northern Ireland), Byley (Cheshire), Cadeby (Leicestershire), Ellistown (Leicestershire), Grantham (Lincolnshire), Lisnaskea (Northern Ireland), Littleport (Cambridgeshire), Lydney (Gloucestershire), Kilrea (Northern Ireland), Magherafelt (Northern Ireland), Uddingston (Lanarkshire) and Weston Underwood (Derbyshire) incorporate the latest computerised batching, distribution, casting, curing and handling systems and are operated by skilled and experienced workforces to ensure consistency of quality. Their geographical spread gives us an unrivalled ability to serve the construction industry throughout the UK and Ireland.

By applying the DFMA principles, FP McCann's design engineers are able to evaluate individual precast concrete products part by part, in addition to documenting the assembly process step by step. This allows them to generate the cost, part count and assembly time to provide a benchmark to measure its success and identify the parts and process improvement opportunities. In turn, this has allowed FP McCann to design and manufacture more cost-effective and efficient high-quality precast concrete products with less wastage and greater on-site recycling. As a result, increased productivity, combined with a reduction in production time and costs, allows FP McCann to be more competitive within the marketplace.

Please note: all information is correct at time of going to print.



8 GOOD REASONS WHY YOU SHOULD USE CONCRETE DRAINAGE

1 SUSTAINABILITY

Concrete pipes outperform other types of pipeline solutions in a number of the environmental impact categories, such as human toxicity levels and chemical / hazardous waste generated. The CO2 emissions from concrete and cement production are relatively small compared to other building materials. Some 95 to 99% of ingredients used in the production of concrete pipes are sourced locally, so a considerable positive impact on the carbon footprint and fuel consumption associated with transporting these materials can be achieved.

2 STRENGTH

Concrete is much more durable than any other kind of pipe. Hence, it can carry more load at any given time and gains strength over time. It cannot be weakened by heat, moisture, mould or pests, nor will it rust. Underground concrete pipes have the ability to resist chemical attacks and massive impacts such as jetting, so blockages can be cleared easily.

3 QUALITY

Since precast concrete pipes are produced in highly controlled plant environments under rigid production standards and testing specifications, they achieve consistent high quality levels of performance.

The pipe production process will normally include computer-controlled mixing systems, computer-controlled weighing and proportioning systems, absorption testing and automated recording systems.

FP McCann's concrete pipes are manufactured in accordance with BS EN 1916 and BS 5911, and certified by Quality Assessment under the Kitemark Scheme and ISO 9001.

4 WHOLE LIFE VALUE

Due to its amazing structural properties and functional benefits, precast concrete pipes tend to attract lower insurance premiums than those built from other construction materials. The natural strength of precast concrete pipes enables recycled aggregate to be used as a bedding material, significantly reducing installation costs and the elimination of waste disposal costs.

5 FIRE-RESISTANCE

Being naturally fire-resistant, concrete forms a highly effective barrier to fire spread and it does not emit any toxic fumes when affected by fire. It will not produce smoke or drip molten particles. Therefore, in the majority of applications, concrete can be described as virtually 'fireproof'. Due to its inbuilt fire resistant properties, concrete not only maintains an airtight construction that stops smoke spreading, but also has the ability to keep its strength during a fire.

6 BEDDING PERFORMANCE

The superior strength of concrete pipes enables recycled aggregate to be used as a bedding material, thus reducing costs and environmental impact during installation. Since a full trench depth of granular material can actually be more expensive than the pipe, significant pipe bedding savings can be achieved when using a concrete pipe instead. FP McCann can advise on the optimum soil and ground conditions from geotechnical reports, to establish when this sustainable and cost-efficient solution can be deployed.

7 CHEMICAL RESISTANCE

Concrete pipes and manholes are resistant to sulphate and chemical attack. Concrete pipeline products with higher design chemical classes of DC3 and DC4 are capable of withstanding attack from the vast majority of aggressive ground environments in the UK.

8 HYDRAULIC EFFICIENCY

The rigidity and mass of concrete pipes (both within the pipe and pipe joints) allows it to retain its shape over its long service life, preserving structural integrity and hydraulic efficiency, by minimising the resistance to water flow that often occurs when the shape or integrity of a flexible pipe is compromised through deformation.

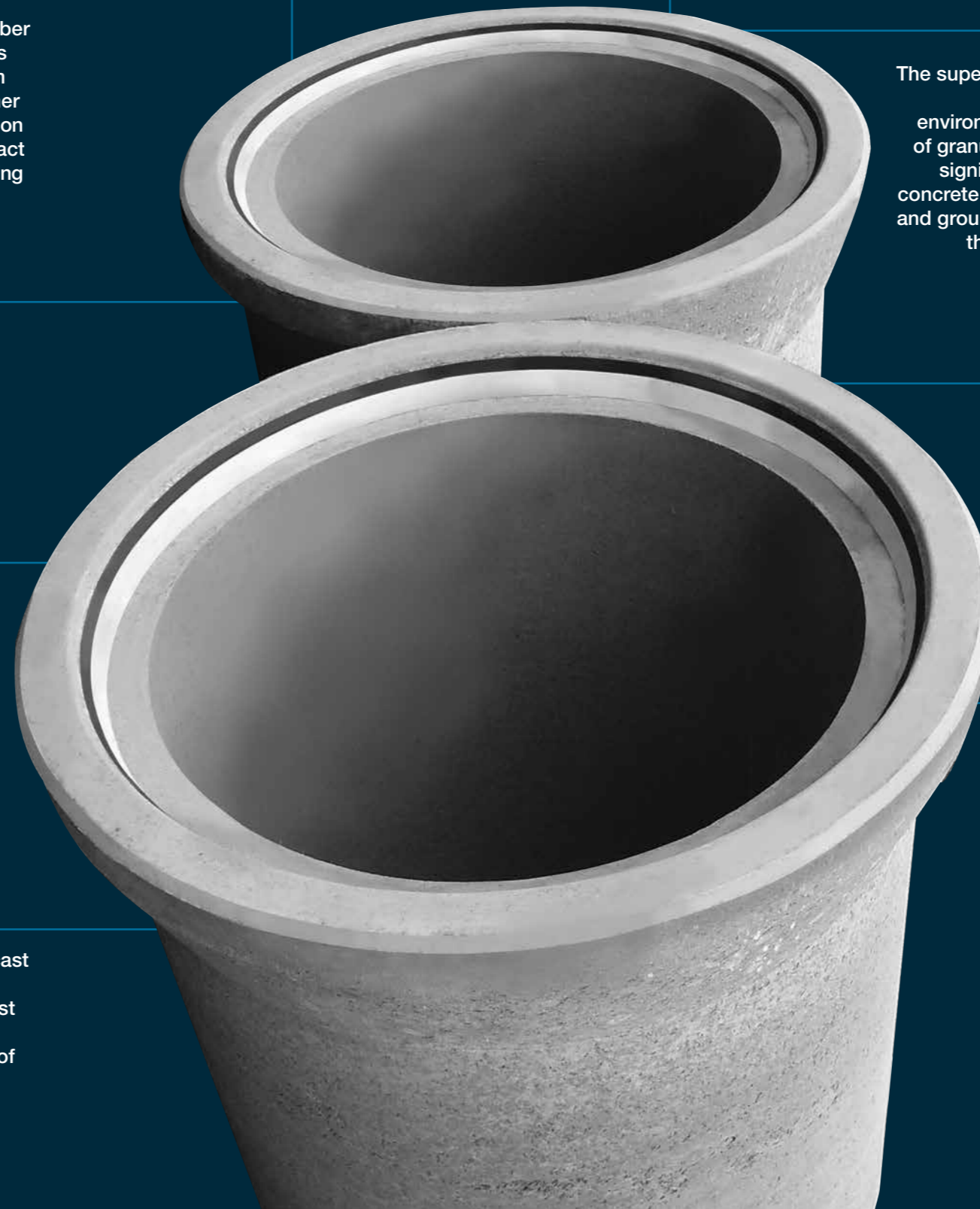

SPIGOT AND SOCKET PIPES

All of our spigot and socket pipes are manufactured and CE marked in accordance with European Standard BS EN 1916, the specification for unreinforced and reinforced concrete pipes (including jacking pipes) and fittings with flexible joints. They are also designed to meet BS 5911 for concrete pipes and ancillary products.



STANDARD PIPES

Nominal Size	DN	300	375	450	525	600	675	750	825	900	1050	1200	*1350	*1500	*1800	*2100	*2400
Internal Diameter	A	300	375	450	525	600	675	750	^805	900	1050	1200	1350	1500	1800	2100	^2380
Barrel Diameter	B	416	505	590	685	790	901	996	975	1080	1266	1460	1620	1800	2130	2460	2750
Socket Diameter	C	497	575	665	760	852	960	1060	1130	1235	1420	1590	1800	2010	2380	2650	2750
Effective Length	MM	2500	2500	2500	2500	2500	2500	2500	2500	2500	2500	2500	2500	2500	2500	2500	2500
Actual Weight	KG	454	616	812	996	1420	1856	2194	1690	2060	2760	3630	4290	5330	7300	9160	10070
Reinforced		N	N	N	N	N	N	N	Y	Y	Y	Y	Y	Y	Y	Y	Y
Approx. Pipes per load		61	45	34	28	22	15	12	17	13	10	8	6	5	4	3	2
Chamber Ring to suit †		1200	1350	1350	1500	1500	1500	1800	1800	1800	2100	2100	2400	2400	2700	3000	3600
Crushing Strengths	Kn/M	36	45	54	63	72	81	90	99	108	126	144	162	180	216	252	288
Nominal Joint Gap	MM	4	4	4	4	4	4	4	4	4	5	5	5	7	7	7	-
Maximum Joint Gap	MM	34	34	34	34	34	34	34	34	34	34	36	36	36	41	41	-
Maximum Deflection	° Degrees	2	2	2	2	2	2	1	1	1	1	1	0.5	0.5	0.5	0.5	-

† Minimum chamber ring size to suit pipe = DN size of pipe + 900

* Lifting anchors available
^ Please note internal dimensions

PIPE LUBRICANT

Pipes should only be joined using an FP McCann lubricant

Nominal size	DN	300	375	450	525	600	675	750	825	900	1050	1200	1350	1500	1800	2100
No. of joints per	KG	27	22	18	15	13	12	10	9	9	8	7	6	5	4	4

Sold in 2.5kg Tubs



ROCKER PIPES

Nominal Size	DN	300	375	450	525	600	675	750	825	900	1050	1200	*1350	*1500	*1800	*2100
Effective Length	MM	600	600	600	600	600	1000	1000	1250	1250	1250	1250	1250	1250	1250	1250
Approx. Weight	KG	145	180	220	300	365	800	950	1020	1020	1200	1605	2020	2755	4440	4620

* Lifting anchors available



SOCKET BUTT PIPES

Nominal Size	DN	300	375	450	525	600	675	750	825	900	1050	1200	*1350	*1500	*1800	*2100
Effective Length	MM	600	600	600	600	600	1250	1250	1250	1250	1250	1250	1250	1250	1250	1250
Approx. Weight	KG	145	174	230	270	370	960	1175	945	1105	1500	1930	2435	3100	4300	5400

* Lifting anchors available

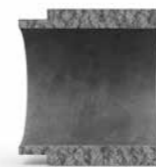

SPIGOT BUTT PIPES

Nominal Size	DN	300	375	450	525	600	675	750	825	900	1050	1200	*1350	*1500	*1800	*2100
Effective Length	MM	600	600	600	600	600	1250	1250	1250	1250	1250	1250	1250	1250	1250	1250
Approx. Weight	KG	100	135	155	205	270	870	980	750	910	1170	1585	1850	2230	3005	3800

* Lifting anchors available



ONE PIECE BEND

Degree	11.25°			22.5°			45°			90°		
	Length (mm)		Weight (kg)	Length (mm)		Weight (kg)	Length (mm)		Weight (kg)	Length (mm)		Weight (kg)
Nominal size (DN)	a	b		a	b		a	b		a	b	
300	115	103	66	160	148	79	257	245	112	618	509	167
375	239	140	117	294	195	142	413	314	199	735	636	270
450	127	79	109	196	148	139	344	296	232	745	698	352
525	97	194	140	179	276	200	335	436	400	828	965	750
600	149	137	188	240	228	289	437	425	513	973	961	898
750	384	115	502	499	230	661	744	475	1087	1412	1143	1810



TWO PIECE BENDS - 11.25°, 22.5° & 45°

Nominal Size	DN	675	750	900	1050	1200	1350	1500	1800
Effective Length	MM	1000	1000	1250	1250	1250	1250	1250	1250
Approx. Weight	KG	775	925	1140	1515	1955	2425	2965	4105



THREE PIECE BENDS - 90°

Nominal Size	DN	675	750	825	900	1050	1200	1350	1500	1800	2100
Effective Length	MM	1750	1750	2500	1750	2500	2500	2500	2500	2500	3000
Approx. Weight	KG	850	1200	1900	2000	2600	3500	4200	5100	6800	7100

Any fabricated/cut bends need to be surrounded in concrete.

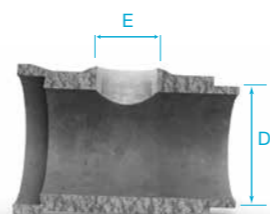

FASTFIT JUNCTIONS

Nominal Size	DN	300	375	450	525	600	675	750	825	900	1050	1200	1350	1500	1800
Branch Size	E	150	150	150	150	150	150	150	150	150	150	150	150	150	150
Effective Length	MM	600	600	600	600	600	1000	1000	1250	1250	1250	1250	2500	2500	2500
Approx. Weight	KG	132	169	211	277	350	750	905	800	1140	1513	2427	4416	5120	7360

All junctions are to be fitted on their side. Junctions are not designed for vertical surface compaction and need to be surrounded in concrete.

For information on our different Pipe Sealing options, please view pages 31-33.

OBLIQUE (45°) TUMBLING JUNCTION (SPIGOT)

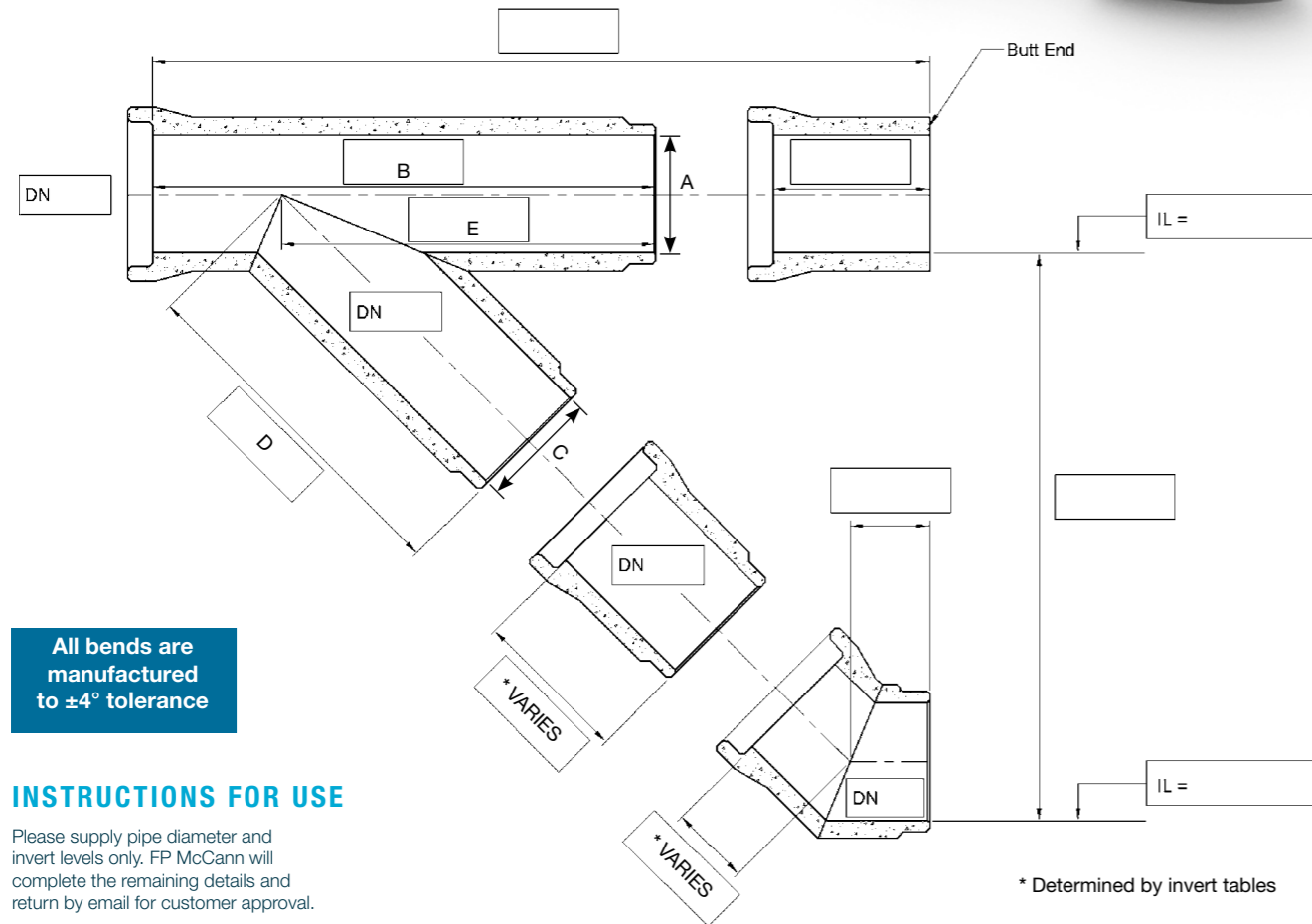
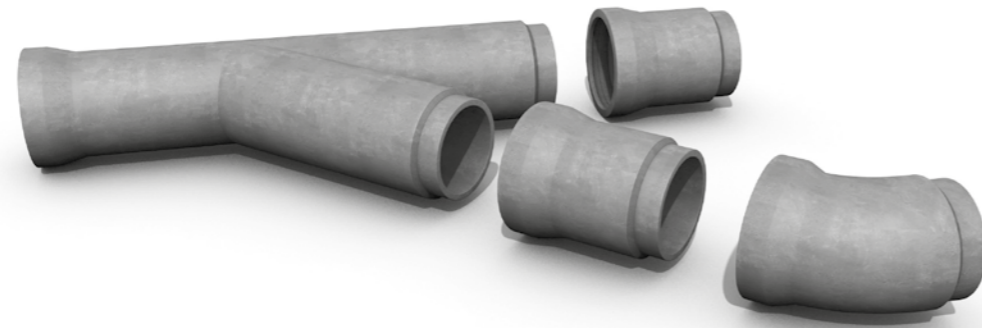

All bends are manufactured to $\pm 4^\circ$ tolerance

INSTRUCTIONS FOR USE

Please supply pipe diameter and invert levels only. FP McCann will complete the remaining details and return by email for customer approval.

Oblique (45°) Spigot Tumbling Bay Junction											
Main Pipe	Nominal Size	A	300	375	450	525	600	675	750	900	1050
	Effective Length	B	2500	2500	2500	2500	2500	2500	2500	2500	2500
Branch Pipe	Nominal Size	C	300	375	450	525	600	675	750	900	1050
	Effective Length	D	870	985	1087	1177	1329	1433	1558	1679	1896
	Effective Length	E	1424	1495	1533	1533	1652	1790	1739	1703	1795
	Approx Weight	Kg	520	696	873	1350	1458	2311	2828	3654	3875

Oblique (45°) Socket Tumbling Bay Junction											
Main Pipe	Nominal Size	A	300	375	450	525	600	675	750	900	1050
	Effective Length	B	2500	2500	2500	2500	2500	2500	2500	2500	2500
Branch Pipe	Nominal Size	C	300	375	450	525	600	675	750	900	1050
	Effective Length	D	870	985	1087	1329	1329	1433	1558	1679	1896
	Effective Length	E	1014	989	943	864	862	819	759	623	535
	Approx Weight	Kg	572	748	940	1450	1550	2400	3090	3885	4199

SQUARE (90°) TUMBLING JUNCTION (SPIGOT)

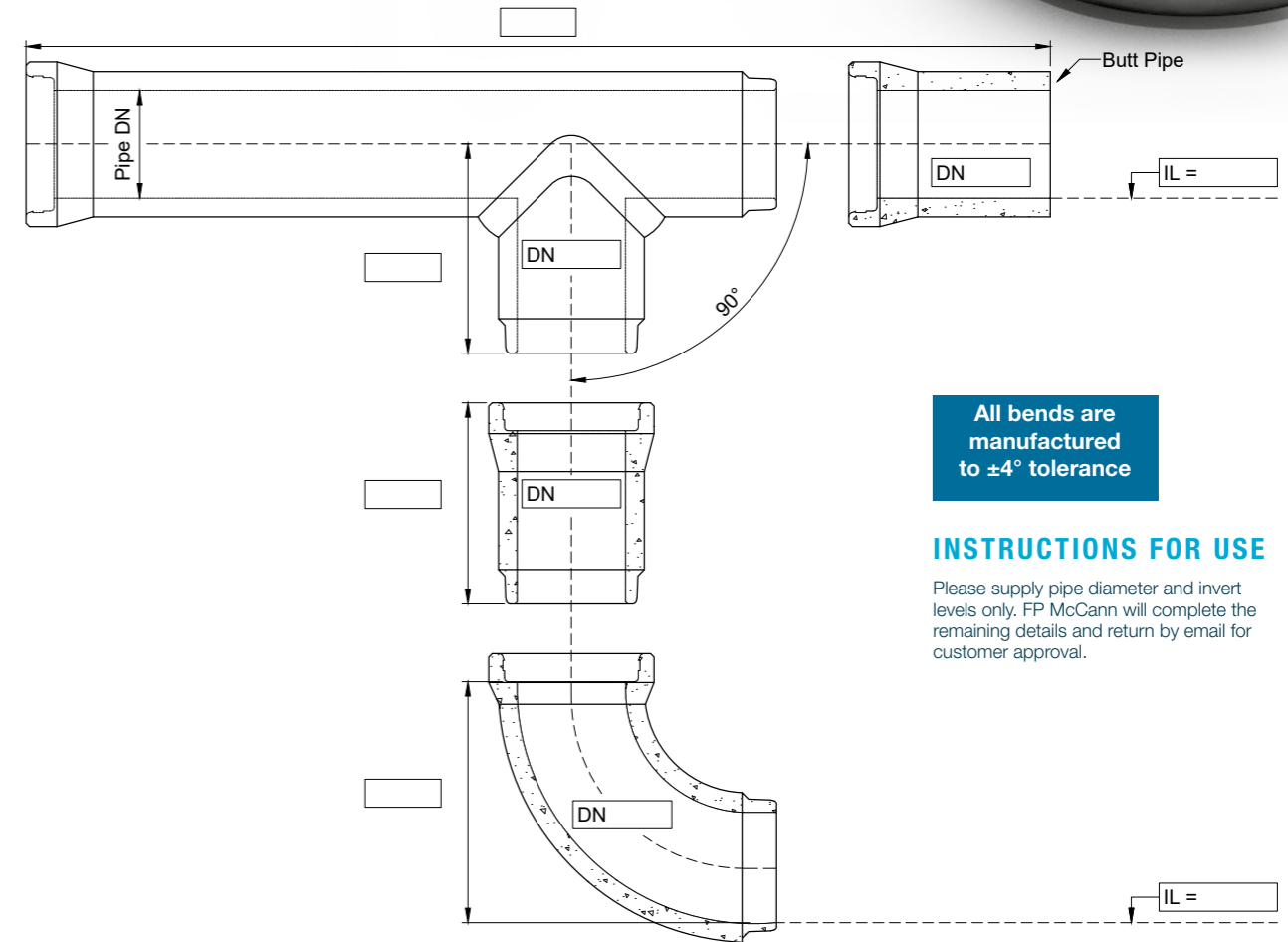

All bends are manufactured to $\pm 4^\circ$ tolerance

INSTRUCTIONS FOR USE

Please supply pipe diameter and invert levels only. FP McCann will complete the remaining details and return by email for customer approval.

Square (90°) Spigot Tumbling Bay Junction												
Main Pipe	Nominal Size	A	300	375	450	525	600	675	750	900	1050	1200
	Effective Length	B	2500	2500	2500	2500	2500	2500	2500	2500	2500	2500
Branch Pipe	Nominal Size	C	300	375	450	525	600	675	750	900	1050	1200
	Effective Length	D	580	628	670	708	770	818	865	1163	1005	1100
	Effective Length	E	1219	1242	1238	1229	1257	1250	1250	915	1165	1165
	Approx Weight	Kg	484	640	827	1098	1396	1453	2457	2964	3370	4374

Square (90°) Socket Tumbling Bay Junction												
Main Pipe	Nominal Size	A	300	375	450	525	600	675	750	900	1050	1200
	Effective Length	B	2500	2500	2500	2500	2500	2500	2500	2500	2500	2500
Branch Pipe	Nominal Size	C	300	375	450	525	600	675	750	900	1050	1200
	Effective Length	D	580	628	670	708	770	710	865	915	1005	1100
	Effective Length	E	1219	1242	1238	1229	1257	1250	1249	1163	1165	1165
	Approx Weight	Kg	540	685	854	1098	1453	1550	2542	3144	3398	4582

PIPE HANDLING/ LAYING INSTRUCTIONS



Recommended site work practice - open cut flexible jointed pipes

HANDLING & STORING PIPES

1. Time and place of off-loading should be agreed before the units arrive at site. The contractor should provide suitable equipment for off-loading, stacking and stringing out of pipes on-site.
2. Off-loading should take place at the nearest hard road to the point of installation. To ensure the safety of all personnel, units must be left in a stable position, well clear of the edge of the trench.
3. Pipes should be inspected before off-loading to ensure that materials delivered correspond with the order placed.
4. Pipes should be carefully checked during off-loading to ensure no units are damaged. Any discrepancies should be recorded on the delivery docket.
5. Where stacking is necessary, this should be done on level ground and the bottom layer of pipes securely chocked to prevent the stack from collapsing. Pipes should be supported under the barrel so that the socket is free of load and to prevent the jointing faces from getting damaged. Preferably, they should be stacked barrel to barrel with sockets hanging over alternative sides.
6. For safety reasons and to prevent damage to the lower layers of pipe in the stack, pipes should not be loaded or stacked in a greater number of layers than is shown in the table below.
7. Avoid damage when handling, especially to ends of concrete pipes. Never drag or roll pipes over the ground.

Note: FP McCann's spigot and socket pipes from DN1350 can be handled using our purpose-built Anchor System. Special lifting anchors can be cast into pipes at manufacture. A Universal Head Link (available from FP McCann) can then be hooked onto the exposed anchor heads to lift the pipe. Lifting anchors are fitted to order.

LAYING PIPES

1. **Trench Excavation** The trench should be excavated to the line, gradient and width, as indicated in the contract documents or as agreed with the engineer. The safety of the public and site personnel is of paramount importance. Care should be taken to ensure personal safety at all times.
2. **Trench Width** Any increase in trench width above that specified could increase the load on the pipe, increasing the quantity of excavation and the bedding material required. A trench narrower than the specified width may impede the proper placing of bedding or backfill material, or the correct jointing of pipes.
3. **Formation** Uniform support along the pipeline is essential. Rock outcrops and soft zones, which can cause differential settlement, should be dug out and replaced with compacted specified backfill material. De-watering may be necessary during pipe laying and subsequent backfilling operations. The specified bedding material should be placed as detailed in the contract specification, and trimmed to ensure uniform support of the pipe throughout the length of its barrel. Recesses should be prepared for the pipe sockets.

4. **Pipe Laying** Before being lowered into the trench, pipes and fittings should be inspected to ensure that they have not been damaged during handling and storage on-site. Units should be lowered carefully into the trench using a recognised lifting tackle, such as a concrete mechanical pipe lifter.
5. **Jointing** Using our pipe jointing instruction guide, all pipe spigots must be fully lubricated with the pipe lube supplied, just prior to being lowered into the trench. Please note: pipes should only be jointed using a FP McCann lubricant. The socket of the laid pipe should, at this stage, be prepared by removing the polystyrene forming ring to leave a clean seal, free from debris. The adjoining pipe should be lowered into position, as level as possible, centring the pipe spigot with the seal of the laid pipe so that the pipes are in line. On achieving this, apply pressure to the socket end of the adjoining pipe using a substantial piece of timber to protect the pipe from damage when pushing the pipe home. (see page 47 for details)
6. **Testing** Acceptance tests on the completed pipeline give an indication of the level of control of workmanship and materials during construction.
7. **Visual Testing** Check for obstructions and debris within the pipe, the structural soundness of pipes, that joints are properly sealed and that the pipe invert is even. Note: pipes smaller than DN750 may be inspected from manholes or by means of TV cameras.
8. **Watertightness** The watertightness of a pipeline may be checked using a water or air test. Such tests will reveal the existence of cracked or porous pipes or faulty joints. These tests should be made during and after laying and before backfilling. The test method will be detailed in the contract specification or referenced to an appropriate code of practice. In certain circumstances (e.g. where the distance between manholes is great, or when site conditions are such that backfilling must take place immediately or when laying small diameter pipelines), it is recommended that the pipeline is tested at regular intervals (say every 2/3 pipes) during construction (see page 47).
9. **Backfilling** This should take place after inspection and testing. The attention given to the backfill selection is of great importance. The placing and compaction of inappropriate backfill may cause damage to a new pipeline. The structural strength of the completed pipeline depends as much on good site workmanship as on the strength of individual pipes. Consequently, all backfill material must be selected and placed as detailed in the contract specification or recognised code of practice.

Note: For additional information on laying and testing pipes, please refer to the BPDA website: precastdrainage.co.uk

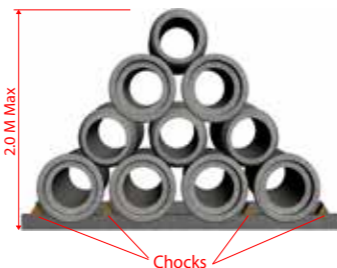

DN	No of layers
300 - 375	4
450 - 600	3
750 - 900	2
> 1050	1

ANCHOR SYSTEM

FP McCann's pipes from DN1350 should be handled using our purpose-built anchor system. Special lifting anchors are cast into pipes at manufacture. A universal head link (available from FP McCann online) can then be hooked onto the exposed anchor heads to lift the pipe.

Use the equal lengths (A & B) for lifting the pipe. Join the longer chain (C) onto the pipe already laid and place the shorter length (B) onto the hook. The pipe can then be jointed without moving the jib of the crane. www.fpmccann.co.uk/anchor-system

ENGAGING AND DISENGAGING THE EYE

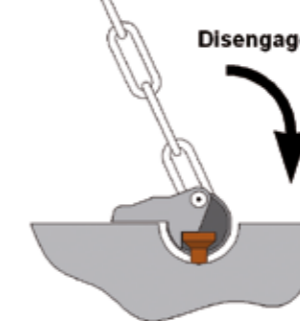
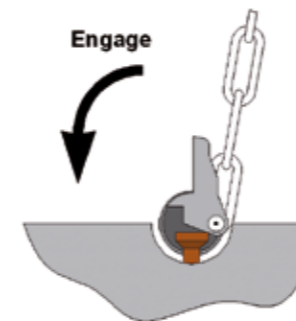

THE CHAIN SET

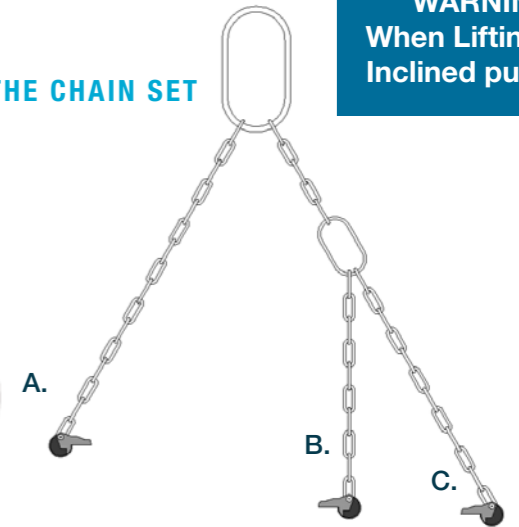

WARNING
When Lifting $\geq 45^\circ$
Inclined pull only

JOINTING

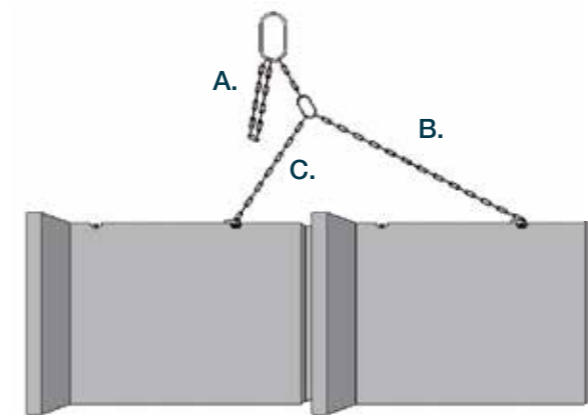

LIFTING AND HANDLING

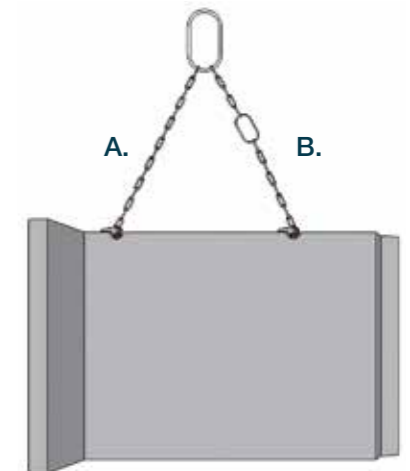

Nominal Size	DN	300	375	450	525	600	675	750	825	900	1050	1200	1350	1500	1800	2100	2400
Anchor Availability		N/A	N/A	N/A	N/A	N/A	N/A	N/A	N/A	N/A	N/A	N/A	✓	✓	✓	✓	✓

Anchor system available from 1350mm diameter upwards (Available in DN1200 in NI only) / * Lift only not jointing

NOTES:

1. All dimensions are in mm.
2. Weights in kg are based on a concrete density of 2500kg/m³.
3. Where relevant, pipes are manufactured in accordance with BS EN1916.
4. Normal practice is to determine left or right branch laterals to the main line by looking up the flow i.e. from the socket end.

5. Right hand or left hand junctions (viewed socket to spigot) should be specified when ordering reduced junctions in pipe diameters DN1350 and above.
6. Lifting chains are not suitable for joining purposes in pipes of diameter DN2400. Joint in the traditional method.
7. Do not install vertical junctions.

PIPE LIFTING INSTRUCTIONS

LIFTING CHAINS

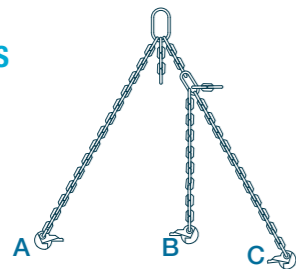

Nominal Size (mm)	1800	2100	2400
Medium Duty Chain Set	3	3	X
Heavy Duty Chain Set	X	X	*3

*Only suitable for Lifting not Joining

HANDLING/LIFTING INSTRUCTIONS

DN1800 to DN2400 pipes are designed and manufactured to incorporate FP McCann's jointing and lifting systems.

LIFT SYSTEM

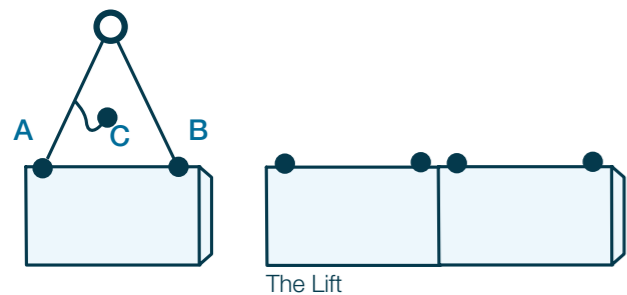

To lift the pipes, select the two short legs A and B on the chain set. Place the spherical coupling over the cast-in anchor and engage by turning the tail of the head link down to the concrete. The pipe can then be lifted as normal.

Never pass slings or other lifting appliances through the barrel and never lift more than one pipe at a time.

JOINTING

Ensure pipe sockets and spigots are not damaged. Ensure that integral seals are not damaged and apply the approved lubricant. For pipes without an integral seal, ensure the seal is of the correct size and is not damaged. Position the rubber ring on the end of the spigot. Under no circumstances use lubricants when using seals of this type, as they are pre-lubricated internally.

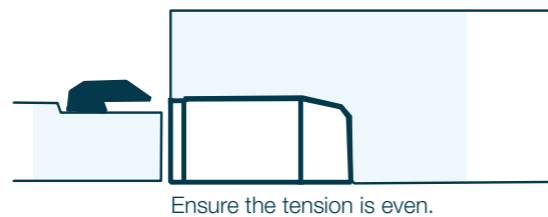

Ensure the tension is even.

Ensure each pipe to be laid is aligned with the laid pipeline and is fully supported along its length. Recommended method of joining pipes is shown below.

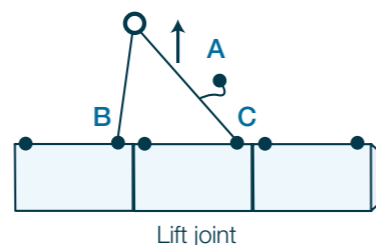

To joint the pipe using the chain system, attach the long leg A and the short leg B to the already laid pipe C. Take up the slack in the chains with the lifting pulley over the anchor of the laid pipe, and increase the upward force to joint the pipes. When jointed, ensure that there is no excessive slew or misalignment, this can easily be checked by reference to the joint gap.

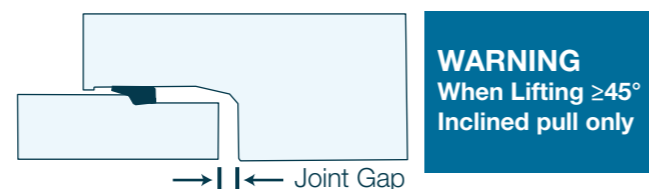

NOTES:

- All dimensions are in mm.
- Weights in kg are based on a concrete density of 2500kg/m³
- Where relevant, pipes are manufactured in accordance with BS EN 1916.
- Normal practice is to determine left or right branch laterals to the main line by looking up the flow i.e. from the socket end.
- Right hand or left hand junctions (viewed socket to spigot) should be specified when ordering reduced junctions in pipe diameters DN1350 and above.
- Lifting chains are not suitable for joining purposes in pipes of diameter DN2400. Joint in the traditional method.
- Do not install vertical junctions.
- In-wall pipes do not require lubrication.

ONE PIECE INTEGRAL RUBBER SEAL

FP McCann now provide a new type of integral seal for their precast concrete pipes. This new integrated seal is a simple, one-piece rubber compression connector which is embedded in the concrete when the pipe is cast. The seal is compressed between the pipe and the concrete, creating a flexible watertight seal.

FEATURES

- The seal complies with all relevant European standards, including EN 681-1, ISO 90001 and QR 4060
- Durable synthetic EPDM rubber seal with over 100 years shelf life
- Seal is cast accurately and stable at the precast factory
- Pipe is cast with numerous holding parts to keep the seal in place
- Clean, high quality sockets
- Ideal for use with mechanical laying techniques such as pipelifter
- Pipes arrive at site ready to be connected

Please note: During the changeover phase, our new integral seal is fully compatible with our current seal

AIR TEST ONLY (A.T.O.) INFLATABLE PIPE STOPPER

Air testing is a quick and easy way of checking a pipeline following installation. Correct assembly of joints, workmanship and the prevention of site handling damage can be identified by this test. FP McCann recommends the use of inflatable stoppers when air testing concrete pipes. Associated test equipment should be in good condition and in full working order. FP McCann recommends that this test is done every 2-3 pipes before backfilling, regularly following backfill during the installation and then at the finish; preferably before both manholes have been constructed.

The pipeline should be pressurised with air until the 'U' gauge (manometer) indicates 100mm. Allow a minimum of 5 minutes for stabilisation of the air pressure, longer may be needed in cold or very hot weather. Observe the fall in indicated pressure over a 5 minute test period. The test is successful if the residual pressure does not fall below 75mm within the 5 minute test period.

If the pressure falls sharply and the pipeline appears to have failed, the following checks should be carried out:

- Inspect the seal of the inflatable stopper against the inside of the pipe using soapy water. Use pipe lubricant or industrial soap to assist in providing a seal where necessary



BENEFITS

- Integrally cast into the structure of the pipe
- Environmentally friendly as it eliminates the need for the polystyrene strip
- Reduction in waste on site
- No cavities or steps in joints
- Almost zero push back
- Requires low insertion force
- Seal not sensitive to weather or forget
- No clamps required to tighten or forget
- Fast and easy installation
- Pipes may be backfilled immediately
- Less time in excavation
- Durable, reusable casting forms

Important Jointing Information

The integral pipe-seal jointing system used in FP McCann's drainage products requires the use of a FP McCann proprietary lubricant, which can be supplied with all pipeline orders from us. Failure to use the proprietary lubricant in accordance with the instructions provided by the pipe-seal manufacturer / FP McCann, may give rise to problems with pipe jointing and seal performance and invalidate any warranty, implied or otherwise. FP McCann accepts no responsibility whatsoever for problems or loss of performance arising from any such failure.

- Check the connections, rubber tube and stoppers for leaks
- Temperature and humidity changes can significantly affect the test. It may be necessary to allow more time for stabilisation or repeat the test in extreme weather conditions

If difficulties are still being experienced following these checks, please contact FP McCann for further assistance.

Please note that failure to adhere to the advice given above and on the FP McCann website may result in any subsequent claims being invalid. Call-out charges may also apply if FP McCann's technical personnel have to attend on site.

Failure to successfully pass an air test does not prohibit the acceptance of pipeline if a successful water test can be obtained in accordance with BS EN 1610.



PRE-LUBRICATED PIPES

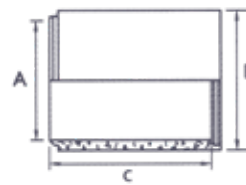

STANDARD PIPES

Nominal Size	DN	1800	2100	2400
Internal Diameter	A	1830	2076	2380
Barrel Diameter	B	2140	2410	2750
Effective Length	C	2500	2500	2500
Approx. Weight	KG	6525	7960	10070
Pipes per Load	Qty	4	3	2

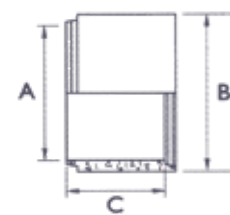

ROCKER PIPES

Nominal Size	DN	1800	2100	2400
Internal Diameter	A	1830	2076	2380
Barrel Diameter	B	2140	2410	2750
Effective Length	C	1250	1250	1250
Approx. Weight	KG	3310	4010	5040

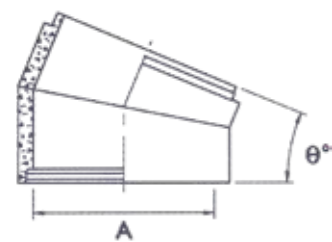

TWO PIECE BENDS

Nominal Size	DN	1800	2100	2400
Internal Diameter	A	1830	2076	2380
Angle θ°		11.25	3	3
Angle θ°		22.5	3	3
Angle θ°		45	3	3

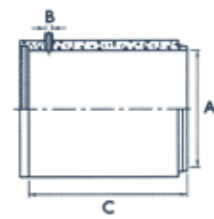

RIGHT ANGLE (90°) REDUCED JUNCTION

Nominal Size	DN	1800	2100	2400
Branch Supersleeve	A	100	100	100
Branch Supersleeve	B	150	150	150
Effective Length	C	2500	2500	2500
Approx. Weight	KG	6525	7960	10070

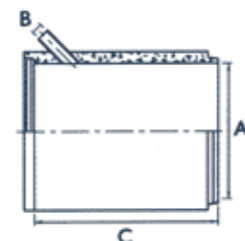

OBLIQUE (45°) REDUCED JUNCTION

Nominal Size	A	1800	2100	2400
Branch Supersleeve	B	100	100	100
Effective Length	C	2500	2500	2500
Approx. Weight	KG	6525	7960	10070

NB: Dimensions above are in mm.

Fastfits available 150mm Super sleeve made to order. Can connect to other pipes via additional adaptors not supplied

Note:

All junctions are to be fitted on their side. Junctions are not designed for vertical surface compaction.

Under no circumstances should lubricants be used when assembling pre-lubricated pipes; the seal is lubricated internally.

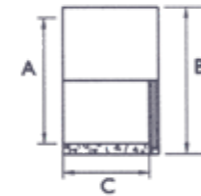

SPIGOTT/SOCKET BUTT PIPES

Nominal Size	DN	1800	2100	2400
Internal Diameter	A	1830	2076	2380
Barrel Diameter	B	2140	2410	2750
Effective Length	C	1250	1250	1250
Approx. Weight	KG	3370	4095	5195

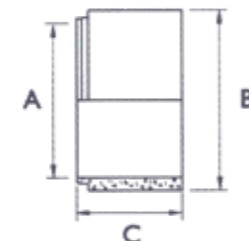

SPIGOT BUTT PIPES

Nominal Size	DN	1800	2100	2400
Internal Diameter	A	1830	2076	2380
Barrel Diameter	B	2140	2410	2750
Effective Length	C	1250	1250	1250
Approx. Weight	KG	3020	3610	4670

MANHOLE CHAMBERS

MANHOLE CHAMBERS (TONGUE & GROOVE JOINT)

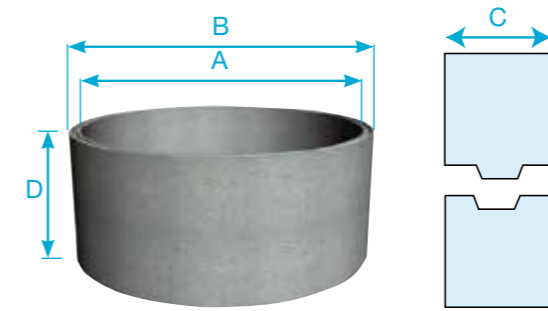

Tongue and Groove Joint Profile



Nominal Size (A) (DN) (mm)	Available Depth of Section (D)				Wall Thickness (C) mm	Litres per metre	Barrel Diameter (B) mm	Approx Weight Kg. (per metre)	Approx. Products per load Qty. (metre)	Lifting Hole Qty/Dia. (per /unit) (mm)
	250mm (±25mm)	500mm (±25mm)	750mm (±50mm)	1000mm (±50mm)						
900	✓	✓	✓	✓	70	656	1040	520	38	3 x 45
1050	✓	✓	✓	✓	80	894	1210	690	34	3 x 45
1200	✓	✓	✓	✓	90	1167	1380	880	26	3 x 45
1350		✓	✓	✓	95	1478	1540	1050	22	3 x 45
1500		✓	✓	✓	100	1824	1710	1300	16	3 x 45
1800		✓	✓	✓	115	2544	2030	1750	12	3 x 45
2100		✓	✓	✓	125	3464	2350	2040	10	4 x 50
2400		✓	✓	✓	140	4514	2680	2790	8	4 x 50
2700		✓	✓	✓	150	5725	3000	† 3400	8	4 x 50
3000		✓	✓	✓	190	7069	3380	† 4700	5	4 x 50
3600		✓	✓	✓	185	10179	3970	5400	5	△ 3 x RD30
4000			✓	✓	200	12566	4400	*7200	4	△ 4 x RD36

MOL from 900-1500 / * 2 piece chamber ring - 3600kg per piece (4m diameter)

△ 570 long wavy tail anchors † 5% Safety Factor

PRODUCT INFORMATION

- FP McCann's manhole chamber rings are manufactured with tongue and groove joints and comply with BS EN 1917 / BS 5911-3
- Manhole chambers from DN900 - DN1800 have 3 lifting points.
- Manhole chambers from DN2100 - DN3000 have 4 lifting points.
- DN3600 and DN4000 are outside of the scope of the British Standard (Non-Kitemark), but comply with all relevant provisions of the European Standard. DN4000 is supplied in two halves

NB: NI have 3 lifting points

WARNING
When Lifting $\geq 45^\circ$
Inclined pull only

RECOMMENDED SITE WORK PRACTICE - MANHOLE CHAMBERS

RECOMMENDED LIFTING EQUIPMENT

Nominal Size DN (mm)	Lifting Hole Qty/dia (p/Unit)	36mm lifting pin 3.5 t SWL	42mm lifting pin 3.5 t SWL	3 leg lifting chain 3.1t	4 leg lifting chain SWL 6.7 t
900	3 x 45mm dia	✓		✓	
1050	3 x 45mm dia	✓		✓	
1200	3 x 45mm dia	✓		✓	
1350	3 x 45mm dia	✓		✓	
1500	3 x 45mm dia	✓		✓	
1800	3 x 45mm dia	✓		✓	
2100	4 x 50mm dia		✓		✓
2400	4 x 50mm dia		✓		✓
2700	4 x 50mm dia		✓		✓
3000	4 x 50mm dia		✓		✓
3600	3 x RD30 (Loops)			✓	
4000	4 x RD36 (Loops)				✓

Dia + 5mm

HANDLING & INSTALLING MANHOLES

1. Time and place of off-loading should be agreed before the units arrive at site. The contractor should provide suitable equipment for off-loading. For safety reasons, all chamber sections are loaded and delivered chimney fashion.
2. Off-loading should take place at the nearest hard road to the point of installation. When off-loaded, units should never be stored on their side (on the roll) but always be laid in the 'as installed' upright position.
3. Carefully inspect units during off-loading to verify that products are undamaged and comply with order placed. Note any discrepancies on the delivery docket and advise accordingly.

MANHOLE SOAKAWAYS

MANHOLE SOAKAWAY CHAMBERS

Nominal Size DN (mm)	No. of 75mm holes per chamber			Wall Thickness mm	Litres per metre ring	Barrel Dia. mm	Approx Weight Kg. (p/metre)	Approx. Products per load Qty. (metre)
	500 mm	750 mm	1000 mm					
900	5	8	10	70	656	1040	520	46
1050	6	9	12	80	894	1210	690	34
1200	7	10	14	90	1167	1380	880	26
1350	8	11	15	95	1478	1540	1050	22
1500	8	13	17	100	1824	1710	1300	18
1800	10	15	20	115	2544	2030	1750	12
2100	12	18	24	125	3464	2350	2040	10
2400	14	20	27	140	4514	2680	2790	8
2700	15	23	31	150	5725	3000	† 3400	6
3000	17	25	34	190	7069	3380	† 4700	5
*3600	20	31	41	185	10179	3970	5400	5
*4000	23	34	45	200	12566	4400	6800	1.5

* DN3600/4000 see Manhole Chambers / DN3600/4000 Manhole Soakaways made to order
† 5% Safety Factor

CONSTRUCTION

To ensure that the manhole structure is vertical, accurate levelling of the formation or the in-situ concrete foundation is essential. Please note: the depths of each manhole can vary and are subject to tolerances; it is recommended that each unit installed has its depth measured prior to installation, to ascertain if the levelling requirements are satisfactorily met. Tongue and groove joints should be installed with the groove facing upward. Manhole sections fitted with double steps can be used at any depth. However, it is recommended that the deepest section of manhole units should be used whenever possible, in order to minimise the number of joints and costs. Precast cover slabs can be laid directly onto the shaft or chamber rings. To allow for any differential settlement between manhole and pipeline, a flexible joint incorporating short length rocker pipes should be constructed as close as possible to the outside of the manhole or the concrete surround, if used. Extra care must be taken to ensure that joints are properly made.

JOINTING

Precast manhole components are provided with joints formed within the wall section. These are sealed with cement and sand mortar, or with proprietary FP McCann mastic sealants. Precast concrete manhole units, well jointed, provide an adequate seal under normal conditions.

REINSTATEMENT

A well-constructed precast manhole is a strong, durable structure with its own inherent strength and will only require an in-situ concrete surround for exceptional structural reasons. A concrete surround is usually specified to assure the chamber is watertight. Generally, adoption authorities prescribe a concrete surround is used with traditional precast manhole units (wall thickness less than 125mm) but it is not required for the wide walled precast units (wall thickness 125mm and above). However, watertightness should be given consideration where the distance from ground level to the base of the chamber exceeds 5m. Further measures may be required for the chamber rings below 5m depth in these instances, such as the use of a concrete surround. Where a concrete surround is required, it should have a minimum thickness of 150mm, backfilling should take place as each precast manhole section is assembled and it must be brought up evenly and compacted around the manhole to prevent displacement.

TESTING

It is generally unnecessary to apply water tests to manholes. In normal working conditions, manholes are not normally full of water. Prevention of infiltration is of more relevance than exfiltration. If infiltration does occur, it can be seen and remedied by sealing using an appropriate method.

Note: When handling precast products on site, it is recommended that the contractor has the correct lifting equipment in place and adheres to the relevant lifting guidelines and standards. Refer to the BPDA website for further information: <https://www.precastdrainage.co.uk/page/pipe-laying-lifting>



SEALING STRIP

Nominal Size DN (MM)	Sealant Size (metres)	No. of rolls p/joint (metres)	Rolls required Quantity
900	20 x 20 x 4	0.88	1
1050	20 x 20 x 4	1.00	1
1200	20 x 40 x 4	1.13	2
1350	20 x 40 x 4	1.25	2
1500	20 x 40 x 4	1.38	2
1800	20 x 40 x 4	1.63	2
2100	20 x 40 x 4	1.88	2
2400	20 x 40 x 4	2.13	3
2700	20 x 40 x 4	2.38	3
3000	12 x 120 x 6	1.75	2
3600	12 x 120 x 6	2.08	3
4000	12 x 120 x 6	2.33	3

Please note this is a guideline based on sealant supplied by FP McCann only.

DN4000 MANHOLE CHAMBER



The DN4000 manhole chamber sections can be used in a variety of applications such as:

- Water treatment plants
- Stormwater attenuation systems
- Storage tanks
- Catchpits

The DN4000 chamber ring is supplied with a standard tongue and groove joint, connecting bolts and butyl rubber sealant for jointing purposes. The units are designed for use with the FP McCann ladder system. Single units (half ring) are lifted using 3 no. threaded lifting loops connected into threaded lifting sockets that are cast into the units, all of which must be used. Assembled units (full ring) are then lifted using 4 threaded lifting loops.

The 4 metre chamber section comes as a two part unit, which allows for ease of transport and handling.

DN4000 CHAMBER SECTION

Nominal Size (mm)	Section Depth (mm)	Wall Thickness (mm)	Approx. weight per section (kg)	Approx. weight per section when jointed (kg)
4000	1000	200	3400	6800
4000	750	200	2550	5100

DN4000 COVER SLAB – 2 PIECE UNIT (DETAIL FOR STANDARD 600 & 675 OPENINGS)

Nominal Size (mm)	Section Depth (mm)	Overall Thickness (mm)	Overall Diameter (mm)	Approx. weight of half section (mm)	Approx. weight of combined sections (kg)
4000	300	300	4500	6450	11,700

Cover slabs are manufactured in two sections, supplied with standard openings. Standard cover slabs are designed to withstand 30 units of Type HB loading, applied in accordance with BS 5911. If required, cover slabs can be designed to withstand 45 units of Type HB loading. For special opening cover slabs, an engineering drawing and steel specification may be required in order to achieve the desired loading requirement.

FP McCann will provide a technical installation sheet which must be adhered to when installing DN4000 manhole chambers. This is available online or from our sales team.

DN4000 LIFTING/HANDLING & INSTALLATION GUIDE

1. LIFTING

Single units (half ring) are lifted using 3 no. threaded lifting loops connected into threaded lifting sockets that are cast into the units, all of which must be used. The chain angle should not be less than 60 degrees to the horizontal. In order to lift without tilt, the chain lengths will differ. Refer to the diagram opposite for explanation of minimum chain angle and lengths. Alternatively, a spreader beam may be used. Complete units (full ring) are lifted using 4 threaded lifting loops attached to threaded lifting sockets cast into the units. Refer to the diagram opposite for explanation of the location of the lifting sockets to be used. The chain angle should not be less than 60 degrees to the horizontal. Alternatively, a spreader beam may be used. **Note: Using 3 chains to lift a full ring will put unnecessary stress on the concrete and may cause the concrete around the joint to crack.**

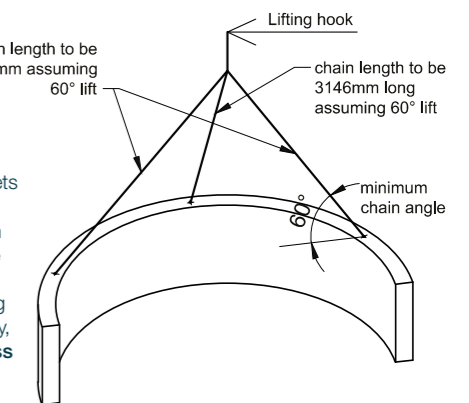

Unit weight and identification of lifting points will be marked on each casting for information.

2. HANDLING & INSTALLATION

It is recommended that the two piece chamber ring is jointed before lifting into place:

- Place the two units on a level surface, ideally on 2 skids to reduce resistance when jointing and also to maintain a clean joint
- Place both halves side by side, ensuring both are at the correct orientation i.e. with bolt holes in line with threaded sockets
- Insert the M24x200 threaded pins with the 60mm threaded side placed into the cast-in sockets
- Place a strip of bituminous sealant along the small recess of the vertical joint on both halves of the ring
- Once bolts and sealant are in position, the 2 halves of the unit must be pulled together using a ratchet system e.g. a chain block fixed to the cast-in M24 x 80 sockets on opposite ends of the units. (Do not use the wall end bolting system to pull the units together as this may crack the concrete and damage the joint)
- The completed ring can then be manoeuvred into place, as detailed above

Half-rings can be lifted into final position and the chamber can be built up, a half unit at a time.

Please note it is the end-user's responsibility to ensure safe access and lifting procedures are followed at all times.

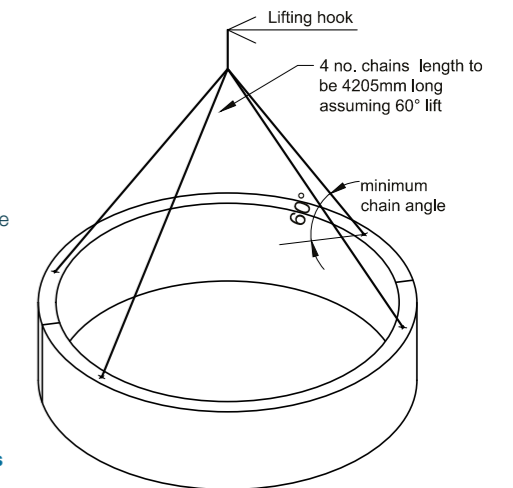

WIDE WALL MANHOLE CHAMBER

FP McCann's precast concrete wide wall manholes have been designed with a tongue and groove dimension to accommodate the use of bituminous sealant. FP McCann's approved sealant should be used at all times. The sealant requirement for wide wall manholes is 12mm x 120mm x 6m. When placing the sealing strip into position during installation, the ends of the strips must be overlapped by a minimum of 30mm and cut at an angle of 60 degree. The cut ends must then be pressed together. Full installation guidelines can be provided upon request or obtained from our website www.fpmccann.co.uk

DN1200, 1500 AND 1800MM WIDE WALL MANHOLE CHAMBERS

A 130mm thick wide wall chamber, in combination with the Easi-Base™ unit, provides a sealed watertight manhole system. This robust design means that the requirement for a concrete surround is eliminated.

PRODUCT BENEFITS

- Quick and easy installation
- Watertight structure
- Safe anchor lifting system (spherical head lifting system)
- Greater cost savings associated with using precast concrete over a traditional system
- No concrete back fill required, in accordance with 'Sewers for Adoption' 7th edition
- More environmentally friendly than a traditional system, almost 40% less carbon omitted during the concrete casting process
- Significant reduction in health and safety risks associated with using precast concrete

Please note: Wide Wall Manhole Chambers are manufactured with 3 x 2.5T Lift Head Anchor points to facilitate the safe anchor lifting system (spherical head lifting system).



WIDE WALL MANHOLE CHAMBER DIMENSIONS

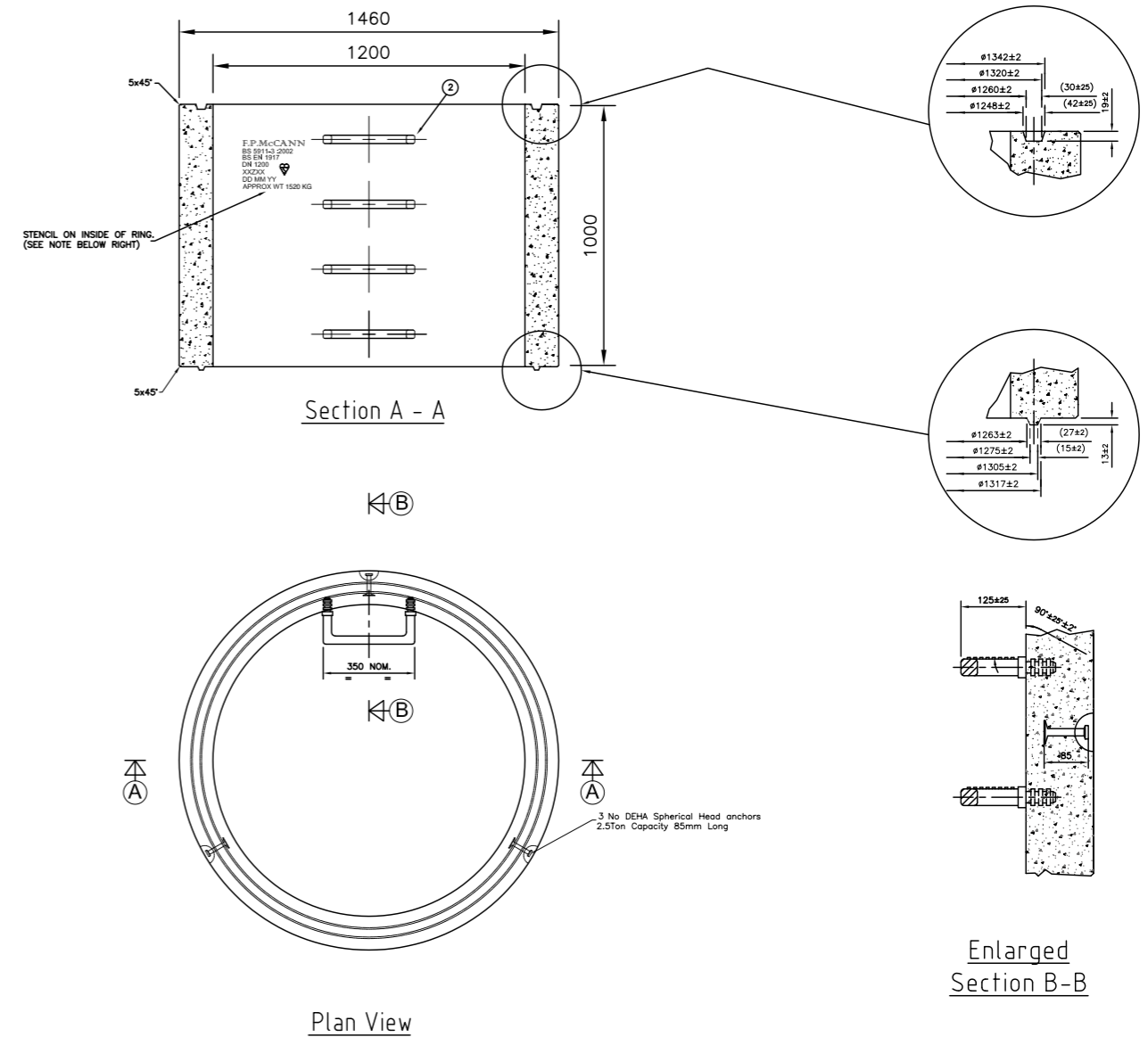

Nominal Size DN (mm)	Available Depth of Section				Wall Thickness (mm)	Barrel Diameter (mm)	Approx Weight Kg. (p/metre)	Approx. Products per load Qty. (metre)	36mm Lifting Pin 0.7t SWL	42mm Lifting Pin 3.5t SWL	3 leg lifting chain SWL 3.1t
	250mm (±25mm)	500mm (±25mm)	750mm (±50mm)	1000mm (±50mm)							
1200	✓	✓	✓	✓	130	1460	1520	16	3x 2.5T Lifting clutches. FP McCann supplies recommended and approved lifting clutches.	✓	
1500	✓	✓	✓	✓	130	1760	1645	14		✓	
1800	✓	✓	✓	✓	130	2060	1970	12		✓	

MANHOLE COVER SLABS & ACCESSORIES

STANDARD LANDING SLABS				
Chamber Section (DN)	Outside Diameter (A)	Opening Diameter (B)	Slab Thickness (C)	Approx. Weight (Kg)
1500	1730	900	200	826
1800	2050	900	200	1292
2100	2375	900	200	2030
2400	2705	900	200	2600
2700	3025	900	200	3880
3000	3330	900	200	4500

NB: All dimensions are in mm, unless stated otherwise

Chamber DN (mm)	Outside Diameter (A) (mm)	Slab Thickness (C) (mm)	STANDARD COVER SLABS		STANDARD REDUCING SLABS				
			Opening Configuration B Size (mm)	Location	Approx. Weight (kg)	Opening Diameter B (mm)	Effective Depth (mm)	Approx. Weight (kg)	
900	1080	150	600x600	CENTRAL	215				
			675x675						
1050	1240	150	600x600	ECCENTRIC	315				
			675x675						
1050	1450	150	750x750	CENTRAL					
1200	1450	150	600x600	ECCENTRIC	455	900	200	385	
			675x675						
			750x600						
1350	1580	170	600x600	ECCENTRIC	650	1050	200	695	
			675x675						
			750x600						
1350	1740	175	1200x675	CENTRAL	980	1200	200	680	
1500	1740	175	600x600	ECCENTRIC	980	900	200	981	
			675x675						
			750x600						
			1200x675						CENTRAL
1800	2070	175	600x600	ECCENTRIC	1460	900	200	1495	
			675x675						
			750x600						
			1200x675						
2100	2380	200	600x600	ECCENTRIC	2180	900	200	2130	
			675x675						
			750x600						
			1200x675						
2400	2710	200	600x600	ECCENTRIC	2800	900	200	2815	
			675x675						
			750x600						
			1200x675						
2700	3030	230	600x600	ECCENTRIC	3750	900	200	3695	
			675x675						
			750x600						
			1200x675						
3000	3420	200	600x600	ECCENTRIC	4970	900	200	4970	
			675x675						
			750x600						
			1200x675						
*3600 Two Piece	4000	300	600x600	ECCENTRIC	9250	Covers to suit Manholes greater than or equal to 1.5m deep cover level to pipe soffit.			
675x675									
750x600									
1200x675									
*4000 Two Piece	4500	300	600x600	ECCENTRIC	11700	*3600mm and 4000mm diameter cover slabs come in a 2 piece unit			
675x675									
750x600									
1200x675									

COVER SLABS

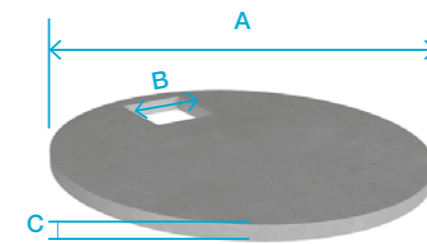

LANDING SLABS

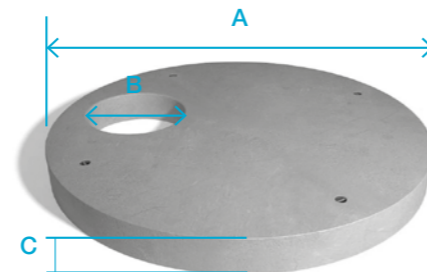

REDUCING SLABS

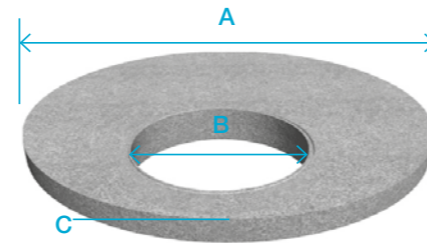

Multiple access/other access sized cover slabs can be made to order

ADJUSTING UNITS & CORBEL SLABS

Manhole Type	Diameter (mm)	Opening Size (mm)	No. per Pack	Thickness (mm)	Weight (kg)
Type 2	1050	600 x 600	15	65	70
Type 2	1050	675 x 675	15	65	55
Type 2	1050	750 x 600	15	65	60
Type 2	1050	750 x 750	10	65	45
Type 2	1575 x 1050	1200 x 675	6	75	160
Type 1	1175 x 1025	600 x 600	10	65	125

Note: A 600 x 600 eccentric corbel slab is also available when using a ladder BS EN 1917 and BS 5911

FP McCann manufactures a full range of adjusting units and corbel slabs that have the following advantages:

- Designed as seating for manhole cover
- Eliminates laying engineering bricks on-site
- Quicker to lay, ensuring reduced labour costs
- 65mm thick – similar to brickwork
- Sits on top of the manhole cover slab
- Eliminates brickwork vertical joint weakspots
- Quality product produced by vibration process
- Comprehensive strength, similar to Class B.Eng bricks

Type 2 600x600

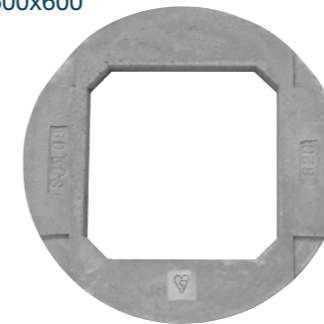

Type 2 675x675

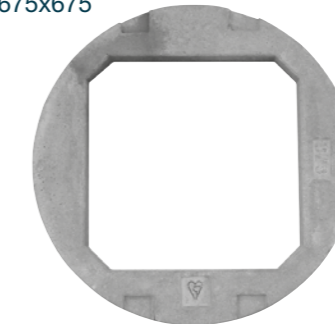

Type 2 750x600

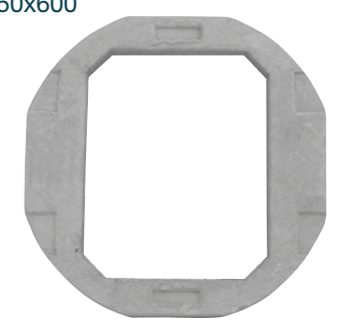

Type 2 750x750

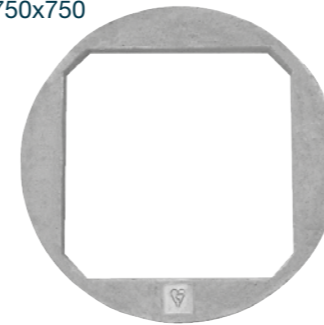

Type 2 1200x675

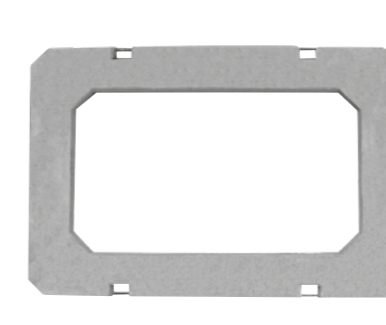

Type 1 600x600 Eccentric (Corbel)

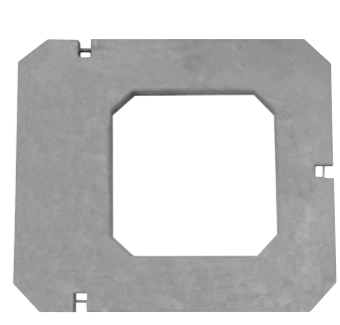

Size (A) (mm)	Slab Thickness (C) (mm)	Openings (B) (mm)	Approx. Weight (kg)
1125x1125	75	600x600/675x675/750x600	140
1125x1125	150	600x600/675x675/750x600	290

LOTHIAN SLAB

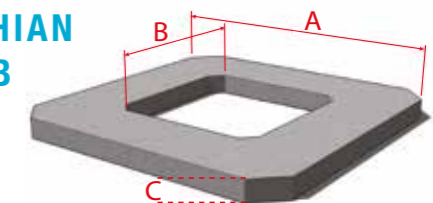

Note: Cover Slab sizes 900-3000 are manufactured in accordance with BS 5911-3. DN3600 and 4000 cover slabs are generally designed in accordance with BS EN 1992-1-1, (for 30 units of Type HB loading, can also be designed to withstand 45 units of Type HB loading). * Weights for DN3600 and DN4000 are estimated weights based on solid slabs.

MANHOLE CONSTRUCTION



DETAIL OF MANHOLE CONSTRUCTION

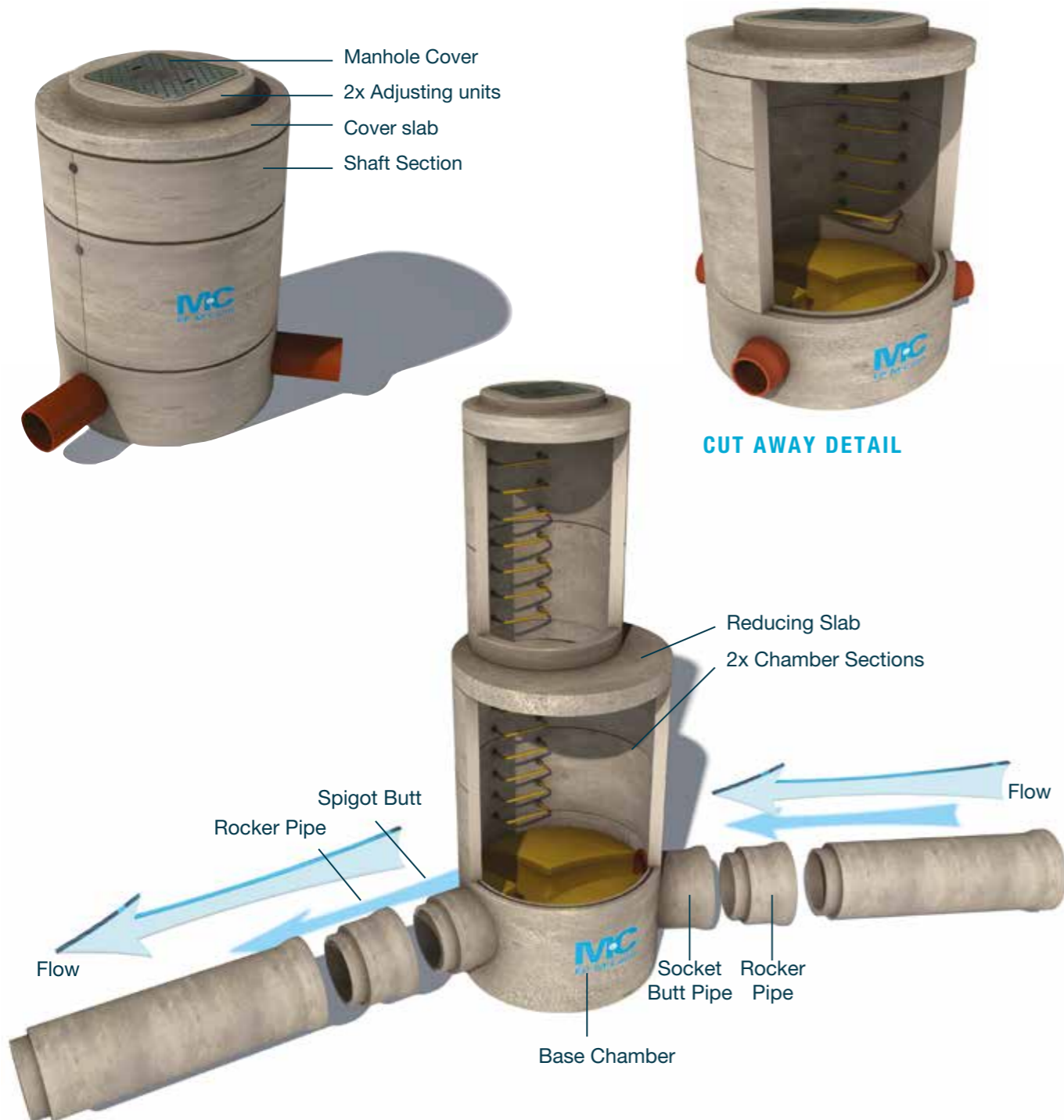

CUT AWAY DETAIL

DN1200 EASI-BASE™

FP McCann's DN1200 Easi-Base™ is a prefabricated manhole base unit with integral benching, channels and connectors, that provides an immediate and long-lasting watertight solution in the management of waste water.

PRODUCT BENEFITS

- An extremely fast, efficient and economical method of constructing manhole bases on-site
- Accepted by all UK water companies
- Significant health and safety benefits
- An immediate watertight structure, allowing other trades to instantly follow on
- Factory prefabrication provides a quality finish to channelling and benching, and enables accurate combinations and variations for entry/exit pipes
- Connects with any type of pipe and is compatible with the DN1200 130mm thick wide wall chamber ring which eliminates the need for backfilling.
- Maintenance of channels and benches are aided by clean access for inspection
- Eliminates the risk of water pollution that is associated with traditional methods of manhole construction, such as concrete base formation integrity failures due to bad weather conditions, which results in groundwater being contaminated with polluted raw sewerage and clean groundwater infiltrating the already overloaded raw sewerage system of pipelines and treatment plants
- The 7th Edition of Sewers for adoption has now been published to include precast bases; Easi-Base™s are in full accordance with the guidance provided.
- Easi-Base™ is a kitemark product, manufactured and tested to BS EN1917
- WRc tested and approved
- An 80 year guaranteed base

The unique DN1200 Easi-Base™ utilises a polypropylene liner with prefabricated benching and channels. Pipe connection bells are pushed into the inlet and outlet points and the liner is then encased and embedded in concrete to provide its structural strength and integrity. The DN1200 Easi-Base™ is manufactured as a monolithic precast unit; it utilises the standard manhole tongue and groove joint and is ready for immediate use, in combination with either a standard 90mm thick manhole chamber or the new 130mm thick wide wall chamber ring.

The Easi-Base™ system connects with most type of pipe including Single wall uPVC, Twin wall, Concrete, Ductile Iron and Clay.

The DN1200 unit allows connection to channel diameters DN150 to DN300. FP McCann has developed a selection of adaptors to increase the range of pipe types accommodated. The type of pipe must be disclosed prior to placing the order, so that the correct adaptors and seals are fitted.

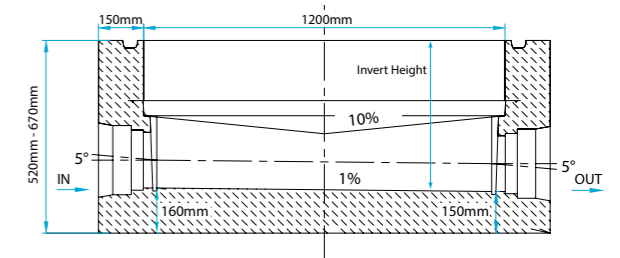

DN1200 EASI-BASE™ UNITS

Diameter	Internal Diameter	Size	Invert Level (for take off)	Depth	Weight
DN1200	150	SMALL	370	520	1.7
DN1200	150	MEDIUM	445	595	1.8
DN1200	150	LARGE	520	670	1.9
DN1200	225	SMALL	470	620	2.2
DN1200	225	MEDIUM	545	695	2.4
DN1200	225	LARGE	620	770	2.5
DN1200	300	SMALL	520	670	2.4
DN1200	300	MEDIUM	595	745	2.5
DN1200	300	LARGE	670	820	2.7

All sizes are in mm

PRODUCT FEATURES

- The DN1200 Easi-Base™ is made to an internal diameter of 1200mm with a tongue and groove joint profile to match standard DN1200 manhole chamber rings
- Wall thickness is 150mm
- The base has a 150mm floor thickness with the outlet invert at approximately 150mm from ground level
- A 1% fall exists across the channel toward the outlet (1:100)
- A gradient of 1:10 is present at the benching with the run-off toward the channel
- The height of the DN1200 Easi-Base™ unit varies in accordance with the diameter of the main channel running through the unit. (Please refer to the above table for heights)



DN1200 RANGE OF LINER ORIENTATIONS

Pipe Size (mm)	PREDL REFERENCE
150	P1, P13, P135, P13579, P14, P147, P149, P15, P157, P158, P159, P16, P169 P17, P18, P19, P2-, P2, P24, P248, P25, P258, P259, P26, P268, P27, P28, P29 P3-, P3, P35, P357, P358, P359, P36, P37, P38, P39, P4-, P4, P45, P46, P469 P47, P48, P49, P5-, P5, P5+, P56, P57, P579, P58, P59, P6, P6+, P68, P69, P7, P7+, P79, P8, P8+, P9
200 *	P1, P15, P159, P19, P2, P3, P4, P5, P59, P6, P7, P8, P9
225	P1, P14, P149, P15, P157, P158, P159, P16, P169, P17, P18, P19, P2-, P2, P248, P25, P257, P258, P259, P26, P27, P28, P29, P3-, P3, P35, P357, P358, P359, P37, P38, P39, P4-, P4, P46, P48, P49, P5-, P5, P5+, P57, P58, P59, P6, P6+, P69, P7, P7+, P8, P8+, P9
250 *	P1, P15, P159, P19, P2, P25, P3, P35, P4, P5, P57, P58, P59, P6, P7, P8, P9
300	P1, P15, P159, P17, P18, P19, P2-, P2, P25, P27, P28, P29, P3-, P3, P35, P37, P38, P39, P4-, P4, P5-, P5, P5+, P57, P58, P59, P6, P7, P7+, P8, P8+, P9

150 Pipe: PVC (EN1401), Polysewer, Marley Quantum, Twinwall, Ultra Rib, Supersleve Clay, Naylor Clay

200 Pipe: PVC (EN1401)

225 Pipe: Polysewer, Marley Quantum, Twinwall, Ultra Rib, Supersleve Clay, Naylor Clay

250 Pipe: PVC (EN1401)

300 Pipe: PVC (EN1401), Polysewer, Marley Quantum, Twinwall, Ultra Rib, Supersleve Clay, Naylor Clay, Concrete

EXAMPLES OF PREDL LINERS STANDARD STOCK

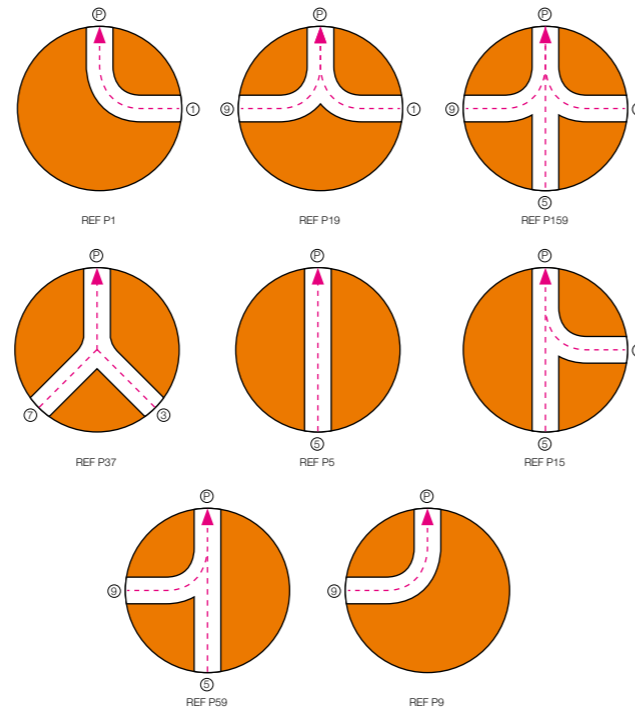

Bonding bridges:
- ensure close adhesion with the concrete encasement of the duct



Anti-slipping protection:
- ensures safe work in accessible ducts

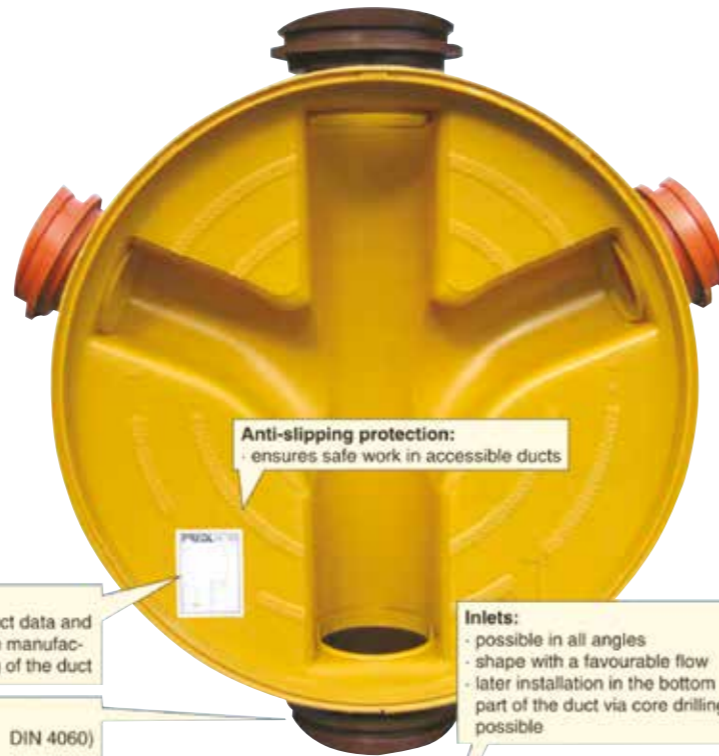

Inlets:
- possible in all angles
- shape with a favourable flow
- later installation in the bottom part of the duct via core drilling possible



Manhole papers:
- the "ID card" of each duct - contains all duct data and ensures complete documentation from the manufacturing of the manhole liner up to the laying of the duct

Manhole lining:
- tight and flexible installation (according to DIN 4060) of all commercial types of drops
- water barrier and silica sand coating prevent lateral water infiltration
- upon request with convex face of the cut functioning as formwork aid

Channel:
- smooth and without any joints, ensures best hydraulics, thereby little effort regarding maintenance and inspections

PREDL® liners are currently used in Germany, Austria, France, Spain, Portugal, Italy, Norway, Denmark and Poland and have achieved accredited quality standards within Europe. FP McCann with franchise partner PREDL® are the first in the British Isles to introduce this new technology to manhole construction. There are over 1500 basic forms of the PREDL® manhole liner that can be delivered in more than 100,000 variants.

EASI-BASE™ ORDER FORM

ORDER DETAILS

Merchant:

Merchant Contact:

Contractor:

Contact Name:

Contact Tel:

Job Details / Address:

Manhole Ref:

Chamber Dia (mm):

Order your Easi-Base™ using the PREDL Clock diagram. The outlet is 'P' with inlets available in any combination from 1-9. Any angles from 90°- 270° are available in accordance with the latest sewers for adoption compliance.

Please consider the example, and use the table below to place your order. One form is required per Easi-Base™.

We can offer a bespoke take-off service on all manholes upon placement of order.

NOTES

- One form required per Easi-Base™.
- It is essential the pipe type is given correctly to ensure the correct pipe seals are provided.

PREDL CLOCK SYSTEM

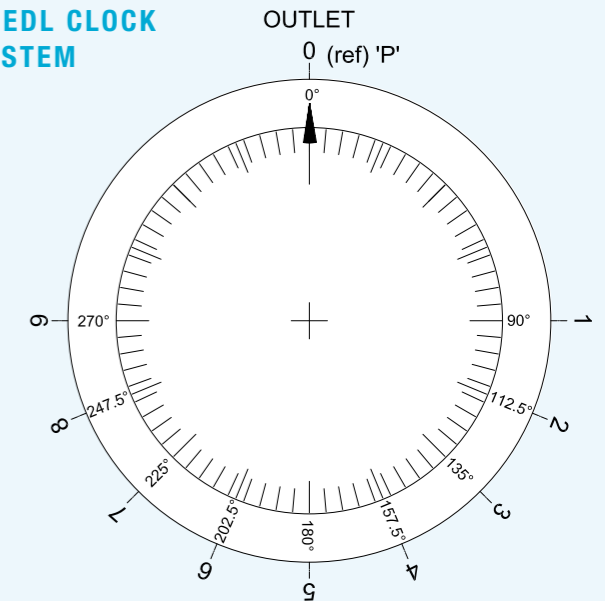

SPECIFYING AND ORDERING YOUR EASI-BASE UNIT

Combinations and variants in entry pipe diameters and orientations can be chosen from the PREDL Clock diagram.

When ordering, it is important to remember that the 'P' refers to the position of the outlet leading from the manhole. All other orientations are specified as a reference from the 'P' position; the next reference is then given as the main channel; each inlet is then referenced firstly by the largest diameter, then by numerical order.

Please see the examples below.

- P5 is a DN1200 Easi-Base™ with straight-through inlet at 180° from the outlet position. Note a 1% fall in the channel exists towards the outlet position 'P'.
- P59 refers to a DN1200 Easi-Base™ with the main channel inlet at 180° from the outlet 'P' position and an additional second inlet at 270°.

Using the PREDL clock reference system, FP McCann can ensure the accuracy of each channel connection.

	Outlet	Inlet	Inlet	Inlet	Inlet	Inlet
	P	1	2	3	4	5
PREDL Ref.	P					
Angle	0°					
Pipe Size						
Pipe Type						
Add. Info.						
EXAMPLE - P 5 1 9						
PREDL Ref.	P	1	5	9	-	-
Angle	0°	90°	180°	270°	-	-
Pipe Size	300mm	150mm	300mm	150mm	-	-
Pipe Type	Wavin Ultrarib	Wavin Ultrarib	Wavin Ultrarib	Wavin Ultrarib	-	-
Add. Info.						

DN1500 - DN2100 EASI-BASES™



FP McCann's bespoke Easi-Bases™ from DN1500 to DN2100 complement our existing manhole ranges and are produced as monolithic units, utilising standard manhole tongue and groove joints for connection with standard manhole chambers. These units are produced wholly from concrete and provide a variety of connection orientations using the Predl Clock System. They can accommodate concrete, clay, twinwall, ductile iron and uPVC pipes from 150mm to 1200mm.

The table below gives the dimensions associated with each size, including the overall height of the unit, the invert level for each different pipe diameter and the combination of pipe diameters accommodated. All Easi-Base™s are made level to soffit, (i.e. level-benching).



DN1500 - DN2100 EASI-BASE™ UNIT SIZES				
Diameter	Pipe Size	Invert Level to top of base	Finished Height	Weight (T)
DN1500	100	470	750	3.50
DN1500	150	470	750	3.50
DN1500	200	575	760	3.50
DN1500	225	575	760	3.50
DN1500	250	575	760	3.90
DN1500	300	705	950	3.90
DN1500	375	755	1000	4.60
DN1500	450	825	1100	4.60
DN1500	525	945	1200	4.70
DN1500	600	1015	1310	4.75
DN1800	100	470	750	6.00
DN1800	150	470	750	6.00
DN1800	200	575	760	6.10
DN1800	225	575	760	6.10
DN1800	250	575	760	6.10
DN1800	300	705	950	6.10
DN1800	375	755	1000	6.50
DN1800	450	825	1100	6.70
DN1800	525	945	1200	7.00
DN1800	600	1015	1310	6.50
DN1800	675	1175	1450	8.00
DN1800	750	1195	1450	7.75
DN1800	825	1255	1500	7.50
DN1800	900	1345	1560	6.85
DN2100*	150-1200	1900	2435	10.50

* 2 part unit / max Δ per unit
† 1 unit ex Knockloughrim depot

All sizes are in mm



WEIGHTS AND LIFTING MECHANISM DETAIL

Easi-Base™ (DN)	Lifting Mechanism	Quantity of Lifters Used per unit	Safe Working Load (S.W.L) per lifter (Tonnes)	Easi-Base™ Unit Max. weight (Tonnes)
1200	M24	3	2.5	1.5 - 2.5
1500	M36	3	6.3	3.5 - 5.0
1800	M36	3	6.3	6.0 - 8.0
2100	M36	3	6.3	6.5
* 2100	Utility Anchors & M36	3 & 3	5 & 6.3	11.0

* Manufactured in NI
(Please note, weights will vary dependent upon pipe size and number of inlets/outlets.)

Our Easi-Base™ manhole systems are manufactured with cast-in lifting sockets to allow chains to be hooked on to lift the base in a safe manner, which will prevent damage during handling. It also negates the requirement to drill holes through the Easi-Base, thus ensuring absolute water tightness when installing in wet ground.



EASI-BASE™ WITH INTEGRAL SEAL



FP McCann's integral seal is a simple, reliable rubber compression connector which is embedded in the concrete when the manhole is cast. The seal is compressed between the pipe and the concrete, creating a flexible watertight seal.

FP McCann is the first precast concrete manufacturer in the UK to offer an integral seal on our Easi-Base™ DN1500 and DN1800 units. Our new integral seal system is a simple, reliable rubber compression connector which is embedded in the concrete when the manhole is cast. The seal is compressed between the pipe and the concrete, creating a flexible watertight seal.



FEATURES

- Connector is placed in the sealing position at the precast plant
- Manhole arrives at the jobsite ready to receive the pipe
- Pipe is beveled and lubricated, and then inserted through connector
- Manhole may be back filled immediately

BENEFITS

- Integrally cast into the structure when the concrete is poured
- Requires low insertion force
- No clamps to tighten or forget
- Fast and easy installation
- Less time in the excavation
- Durable, reusable casting forms
- Reusable tooling holds connector in position during casting process.

* 1050mm and above pipe sizes require grouting using a e-proxy resin or similar approved product

SEALANT

DN1200	12mm x 120mm x 4.2m
DN1500	12mm x 120mm x 5.2m
DN1800/DN2100	12mm x 120mm x 6.0m

EASI-BASE ADAPTORS AND SEALS

Part No.	Size	Pipe O/D	Type	Description
FPM 101	225	250	Adaptor	PVC TW & Ultra Rib
FPM 102	225	N/A	Adaptor	End cap Stock
FPM 103	225	263	Adaptor	Clay (SuperSleve)
FPM 104	225/150	N/A	Adaptor	Level Invert Reducer
FPM 105	225	268	Adaptor	PE Twin Wall
FPM 106	225	N/A	Seal	Uni bell Seal
FPM 107	225	263	Seal	Clay Adaptor Seal
FPM 108	150	170	Adaptor	Ultra Rib
FPM 109	150	N/A	Adaptor	End Cap
FPM 110	150	178	Adaptor	Twin Wall PE
FPM 111	150	178	Adaptor	Clay (SuperSleve)
FPM 112	300	335	Adaptor	Ultra Rib
FPM 113	150	188	Adaptor	Naylor Densleeve
FPM 114	300	353	Adaptor	Twin Wall
FPM 115	150	160	Adaptor	Twin Wall PVC
FPM 116	225	278	Adaptor	Naylor Densleeve

Please note: all adaptors and seals are available from stock

FLEXI-FIT PIPE SEAL

Introducing the new range of sizes for FP McCanns Flexi-Fit seal.

FF150

FF150 Base

FF225

Designed to be used in junctions and large diameter pipes.

Designed to be used in manhole bases and catchpits. Lateral support is required.

Designed to be used in manhole bases and catchpits. Lateral support is required.

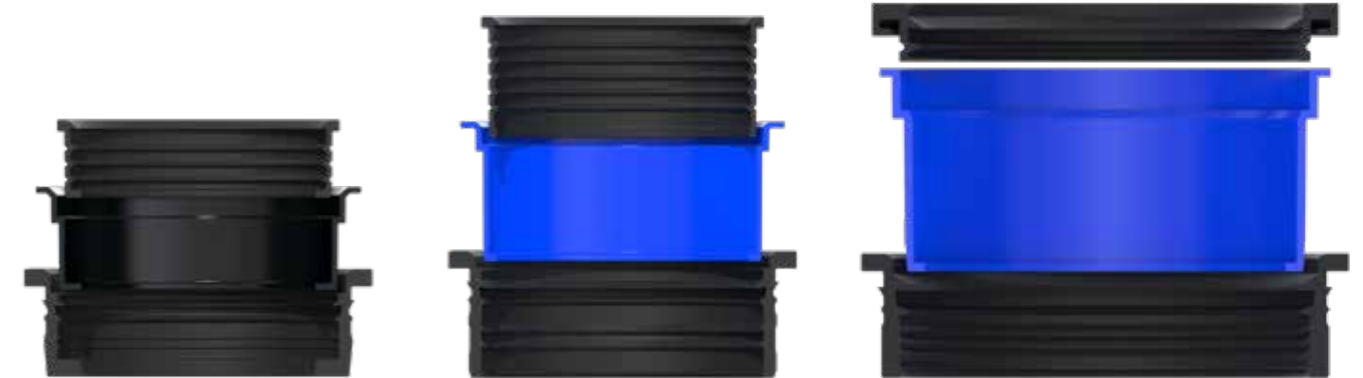

The Flexi-Fit seal is a time and cost saving solution for fitting lateral (or branch) pipes into larger concrete pipes, manholes, junctions, catch pits or other concrete structures, at the time of casting or retro-fitting into a cored hole.

Each seal uses three component parts to adapt its internal size to suit the lateral pipe being fitted. The user can simply remove components to increase the internal diameter of the seal. All components conform to the latest standards for below ground applications. The universal nature of the Flexi-Fit range means that any lateral pipe of the same nominal diameter can be fitted. The Flexi-Fit removes the need to purchase and store multiple seals and adaptors for different pipe materials, simplifies project planning and supports specification changes.

BENEFITS

- Universal solution
- Removes the need for adaptors
- Can be installed in seconds
- Can be cast into concrete during manufacture or cored and retro-fit
- Configuration can be altered in seconds
- Watertight connection for any DN150 & DN225 Lateral
- Smooth transition and level invert through to the connecting structure
- Designed to remove the possibility of lateral intrusion
- Independently tested to 0.5 bar pressure on all adoptable laterals



FLEXI-FIT PIPE SEAL



PIPE FITTING OPTIONS

Option 1 - Full product



Option 2 - Inner Bush removed

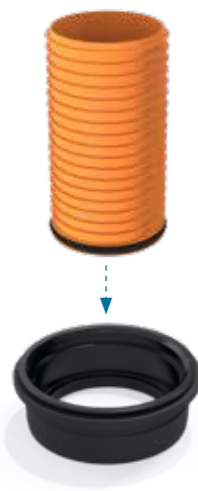

Option 3 - Outer Body only



Product	Pipe Type
FF150 FF150 Base	DN150: PVC Smooth Marley Quantum Polysewer Cast Iron Ultra 3
FF225	DN225: PVC Smooth Cast Iron Ultra 3

Product	Pipe Type
FF150 FF150 Base	DN150: Ultrarib
FF225	DN225: Marley Quantum Polysewer Ultrarib

Product	Pipe Type
FF150 FF150 Base	DN150: Supersleeve Clay All Twinwall pipe types
FF225	DN225: Supersleeve Clay All Twinwall pipe types

Note: the pipe seal must be used in the first groove.

*Not suitable for Naylor Clay - adaptor required with FF150/225

FLEXI-FIT PIPE SEAL



INNER BUSH

CASTING SOCKET

OUTER BODY



Product Code	FF150 / FF150 Base / FF225
Description	DN150/DN225 Universal connector
Core Hole Size	198 +0/-1mm & 294 +0/-1mm
Material	ABS & EPDM Rubber
Pressure Rating	0.5 bar
Jetting Resistance	180 bar
Temperature Range	-50°C to 80°C constant, 100°C intermittent
Standards	BS EN 681-1:1995 WIS 4-35-01

INSTALLATION



5 EASY STEPS

- Using the correct equipment, core a 198mm or 294mm hole at the selected position into the concrete pipe, manhole or junction. Ensure the cored hole and surrounding area is clean and free from slurry/debris.
- Remove the two inner body components from the main outer body as shown in image 2.
- Press the rubber into the 198mm/294mm cored hole until fully seated, a little force will be required.
- Lubricate the outside of the casting socket using water (if required).
- Using a chock of wood and hammer (if required) drive the casting socket into the outer body evenly around the circumference.

Note: It is recommended that a diamond tipped core drill be used to core the 198mm / 294mm holes.

GENERAL INFORMATION

Flexi-Fit Seal has been certified by the British Standards Institution (BSI) as a company of assessed capability, with a quality management system which meets the requirements of BS EN ISO 9001:2015.

A materials cost calculator is available on request. For further information on FP McCann's precast drainage solutions, contact the sales team: SCOTLAND/NI: 028 7954 9026 | ENGLAND/WALES: 01530 240000

DN1050 HIGHWAYS AGENCY CATCHPIT

HIGHWAYS AGENCY COMPLIANT EPDM FLEXIBLE SEAL DN1050 CATCHPIT

With its flexible rubber pipe connector seals, precast concrete catchpits can be utilised on a single lane carriageway, replacing the requirement to cast a base sump in-situ and construct the catchpit from a standard DN1050 manhole ring.

The innovative EPDM 40 flexible rubber seal at the connection points can accommodate pipe sizes DN150, DN225 and DN300. This negates the need to saw cut openings in the concrete wall and the use of wet mortar trades to seal the pipe surround.

Catchpits are supplied with factory fitted pre-marked EPDM 40 rubber blanks. The unique rubber blank/seal has preformed cutting grooves around the three DN entry sizes indicated. This allows for accurate cutting out to pipe diameter requirement. There is no similar system available on the market. Once pipes are fitted into the seal, up to 45 degrees of pipe deflection is permitted without breaking the seal.

Significant savings in time eliminates the need for follow-up finishing gangs. Reduced safety risks because the operative time in excavation is minimal and no power tools are required to cut concrete. Indirect cost benefits arise from saving up to 26 hours of labour time, related to the curing of wet trades on a traditional build.

FP McCann's catchpit products are manufactured under BSI Kitemark approval to comply with BS EN 1917 and BS 5911, and are therefore fully compliant to HA's MCHW specification.



Can be used in straight through, 90° connection or straight through with a cross drain.



Once pipe is fitted to the connector, up to 45° of deflection is possible without breaking the seal.

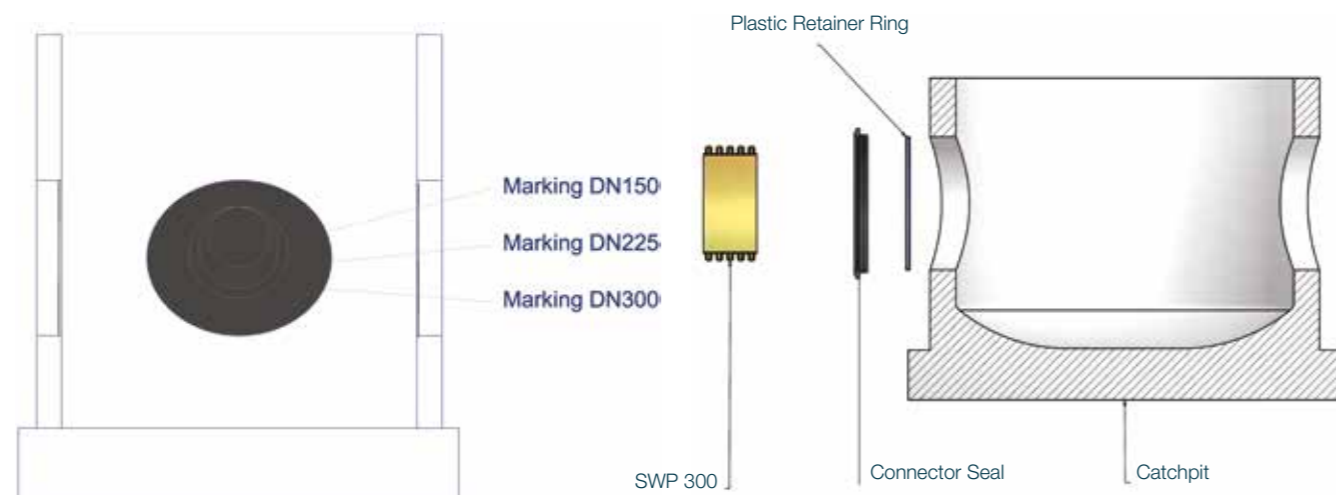

CATCHPIT

The catchpit effectively provides a sealed sump manhole, a monolithic precast concrete unit fitted with connector seals, which can be used to connect to the following types of pipe: uPVC, twin wall, clay, ductile iron and concrete. The catchpit is designed to accommodate pipe sizes DN150 to DN1800 and is in line with highway specification.

PRODUCT BENEFITS

- Creates an immediate watertight structure
- Prefabricated off-site (minimising on-site labour and costs)
- Quick and efficient to install
- Accommodates connection to all types of pipe used in road and manhole construction
- Safety benefits gained in the construction of manholes as the preformed sump and connect seals eliminate on-site construction, thus greatly reducing labour activity within the manhole
- Quality is greatly increased as construction is within the factory environment and complies with BS EN 1917 and BS 5911
- Eliminates material wastage associated with current in-situ method
- Yields environmental benefits such as lower carbon footprint, less concrete used on-site and less excavated material removed from site
- Bespoke designs available



Nominal Size (dn)	Height (mm)	+ Max. Pipe Size (mm)	Chamber OD (mm)	Wall Thickness (mm)	Capacity (l)	**Approx. Weight (kg)	No. of Units per Load	Lifting Hole Qty/ da/ per unit
DN1050	* 1000	300	1210	80	650	1380	19	3no. ø45 lifting holes
DN1200	* 1000	300	1380	90	870	1600	16	3no. ø16 sockets and loops
DN1500T1	* 1400	600	1800	150	1800	4700	5	3no. utility anchors
DN1500T2	* 2400	675	1800	150	3300	7700	4	3no. utility anchors
DN1800T1	* 1500	600	2100	150	2700	^ 6300	4	3no. utility anchors
DN1800T2	* 2400	900	2100	150	5100	8300	3	3no. utility anchors
DN2100	* 2400	1500	2400	150	7000	^ 9000 11000	3	3no. utility anchors
DN2400	* 2700	1800	2700	150	10,500	^ 11700 14000	2	3no. utility anchors

* Height can be reduced to suit customers' requirements Based on 300mm sump. If a non-standard invert level is required, please specify when ordering
^ Lightweight catchpits (available on request)

** Maximum weight of a solid, full height unit with no holes
+ Based on a standard catchpit only. If larger pipe sizes are required, please contact FP McCann

VALVE CHAMBER

FP McCann designs and manufactures a bespoke range of reinforced valve chambers capable of housing any size and type of valve/pump. Valve chambers consist of a precast concrete sealed sump manhole with factory-fitted saddles to house the pump, and are used in the management of water, oils and chemicals.

Chamber Diameter	1200 - 3000mm
Chamber Height	900mm
Stool	Bespoke to project requirements
Pipe Size	150 - 375mm
Inlets / Outlets	Will vary to accommodate pipe size
Cover Slab Thickness	Will vary in accordance with chamber diameter
Base Thickness	250mm

PRODUCT BENEFITS

- Immediate watertight structure
- Reduced installation time/costs
- Accommodates connection to all types of pipe, including concrete, metallic, HDPE and clay
- Pump is raised off the ground and sits on a preformed concrete stool
- Easy and clean access for operation and inspection



STORMBRAKE

VORTEX FLOW CONTROL SYSTEM



A new force in vortex flow technology

Vortex Flow Controls (VFCs) are commonly used in drainage systems to regulate the storm water runoff from urban areas. Through the use of vortex flow technology, FP McCann's StormBrake™ provides the solution to a variety of stormwater management problems. These include accurately controlling storm/surface water flow, minimising upstream storage requirements and reducing the risk of blockages compared to traditional orifice plates.

WHAT IS VORTEX FLOW TECHNOLOGY?

Vortex flow technology is based on the principle of a vortex hydrodynamics, where under sufficiently high upstream water levels a vortex is induced in the flow by the device. The vortex motion results in significant energy loss, creating a pressure drop across the device and restricting the discharge leaving the outlet. The geometric properties of the device control the amount of flow restriction and can be tailored to suit the design conditions for a specific site.

BENEFITS

- Reduces the amount of upstream storage required, minimising the cost of providing attenuation facilities
- Minimal maintenance required after installation. FP McCann's StormBrake™ is self-activating and function without any mechanical components
- Outlet clearances up to 6 times larger than an equivalent orifice plate, significantly reducing the risk of blockages and the associated maintenance costs
- Accurately designed to meet a wide range of design conditions:
 - flows up to 40l/s;
 - heads up to 2m
- Contains a bypass door which can be manually opened at ground level using a pull cable to allow easy access for inspection or blockage removal

For design conditions outside of this range, please contact FP McCann directly



Low water level in the flow control chamber



STORMBRAKE™

VORTEX FLOW CONTROL SYSTEM

DESIGN

FP McCann's StormBrake™ is manufactured using grade 304L / 316L stainless steel for increased durability, strength and resistance to corrosion and chemical damage. It consists of 3 main parts: an inlet section, a vortex chamber and an outlet. Each part can be configured to provide the most efficient solution to specific site requirements.

Each StormBrake™ is fitted with a pivoting bypass door on the front face in line with the outlet pipe. A stainless steel wire cable is attached to the bypass door and extends to the top of the manhole chamber. Upon pulling the cable the bypass door rotates and moves upwards, revealing a clear straight-through channel between the manhole and the outlet pipe. In the event of the StormBrake™ becoming blocked by debris, the bypass door allows fast discharge of water out of the chamber for maintenance.

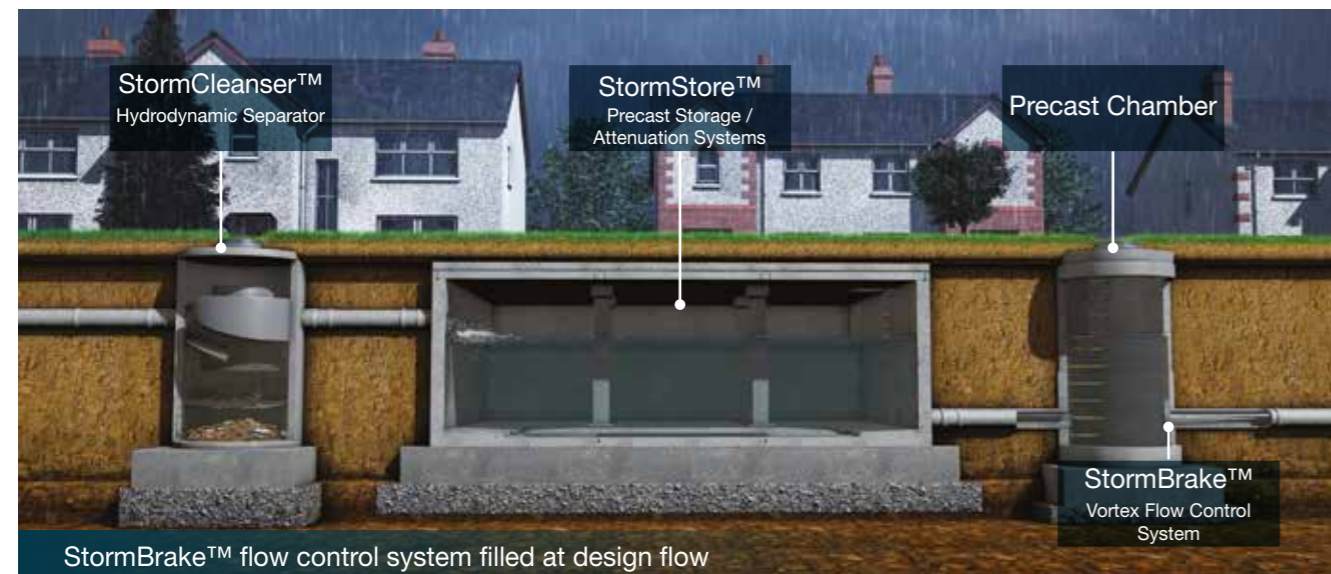

FLOW STAGES

The performance of FP McCann's StormBrake™ is determined by relating the upstream head to the outflow leaving the device. Its performance is characterised by a head-flow curve, which produces a unique 'S'-shape, corresponding to the following three phases of flow:

- (i) **Pre-vortex phase** – hydrodynamics governed by orifice flow. The flow generated by the upstream head is not large enough to induce a vortex in the StormBrake™. This phase occurs until the flush-flow point is reached.
- (ii) **Transition phase** – flow throttling initiated. Vortex continually forms and collapses, resulting in significant energy loss and lower flow rates despite increasing upstream head. This phase is bounded by the flush-flow and kickback points.
- (iii) **Vortex phase** – vortex fully formed with central air core. The air core imposes a quasi-physical flow restriction, reducing the available area in the pipe for outflow.



By changing the geometry of the StormBrake™, the positions of the flush-flow and kickback points can be tailored to suit the clients' needs. For example, the curve below is ideal for situations where upstream storage capacity is limited. The flush-flow point occurs at the design flow, allowing for maximum discharge of water during the early stages of a storm, therefore minimising upstream storage requirements.

VFC HEAD-FLOW CURVE

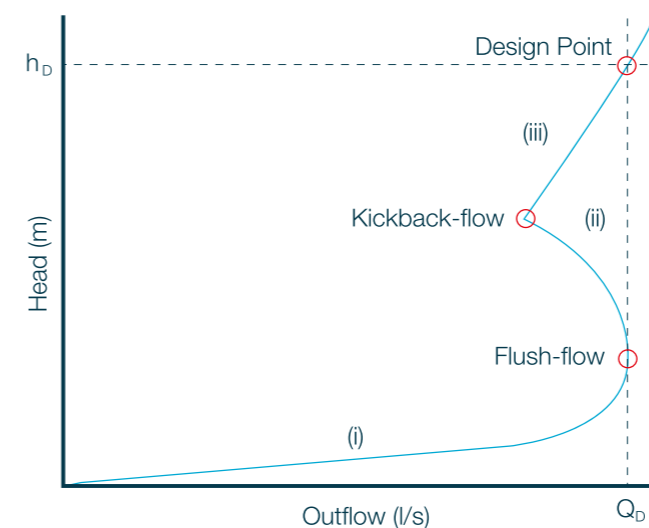

TESTING

FP McCann's in-house development team test the StormBrake™ using a full scale test facility. The test-rig is constructed of the same components that would be used on site, increasing the accuracy and realism of the tests. The team works closely with university researchers to apply state-of-the-art experimental methods and computational fluid dynamics to the development process. To date, over 2.5 million litres of water has been used to characterise the performance of the StormBrake™. This volume is constantly increasing, due to continual development and rigorous hydrodynamic characterisation, ensuring maximum product performance to meet the requirements of each specific site.

INSTALLATION

- 1) Position the StormBrake™ so that the inlet is at the bottom and the outlet surround is resting on the inside of the outlet pipe. Mark the locations of the mounting points on the chamber wall;
- 2) Using the marked locations, drill holes to the required diameter and depth for the supplied masonry anchors. Fix the anchors to the drilled holes.
- 3) Attach the StormBrake™ to the anchor points, ensuring the neoprene gasket is flush with the chamber wall, and fasten the device by tightening the bolts. This will compress the neoprene gasket to provide a watertight seal between the device and the wall.
- 4) Fix the stainless steel wire cable from the bypass door to the underside of the manhole cover, vertically above the device. A secondary bracket is supplied and should be fitted halfway up the chamber to guide the bypass door cable in deeper chambers.
- 5) Adjust the length of the bypass cable accordingly, so that it reaches ground level whilst ensuring the bypass door can open if required.

STORMCLEANSER™

HYDRODYNAMIC SEPERATOR

FP McCann has designed and developed the enhanced StormCleanser™ for the treatment of urban catchment stormwater run-off.

The StormCleanser™ provides a cost-effective solution for designers, engineers and contractors involved in the provision of Sustainable Drainage Systems (SuDS). This unit has no moving parts, requires no power, and is constructed within standard precast concrete chambers.

The standard units come factory fitted in precast chambers and could also be installed on-site as required. The modular stainless steel built assembly is designed to provide installation simplicity. The separator internal assembly is fabricated out of stainless steel (304L/316L), per BSI BS EN 10088-2-2014. Stainless Steel material grade and composition, provides exceptional longevity due to high corrosion resistance. The lifespan of the internal assembly outlasts the lifespan of a typical precast concrete structure (100+ years).

The enhanced StormCleanser™ design allows for an inlet at varying angles with respect to the outlet. Moreover, the design also enables configuration with multiple inlets, at different orientations and of various sizes. The symmetric inlet design provides the freedom of clockwise or counter-wise flow direction, and allows the vortex formation with minimal hydrodynamic losses and turbulence.



Fixed flow direction separators tend to lose efficiency especially when a higher flow inlet is placed ahead of a lower flow inlet. The changeable flow direction provides drainage engineers the freedom to set the desired orientation of multiple inlets. StormCleanser™ allows for preferential flow direction of the main inlet, providing optimum performance for a wide range of configurations. StormCleanser™ is developed with state-of-the-art hydraulics technology, using Computational Fluid Dynamics (CFD) modelling and full-scale experimentation.



OPERATION

The StormCleanser™ is specifically designed to remove suspended solids, hydrocarbons, and floatable debris from the stormwater run-off. Water and pollutants enter the system via the inlet pipe, where the internal geometry enables low energy forced vortex flow patterns. This allows the floatables to gather and solids to settle to the bottom of the treatment chamber for subsequent removal.

Settled sediment is retained within the sump storage of the unit, allowing easy access for suction cleaning. Re-suspension of the solids is minimised by the provision of a baffle plate (Catch Skirt), positioned above the sediment storage sump. A central core allows for convenient suction hose entry down to the sump for cleaning and maintenance. If there is a stormwater surge in excess of maximum treatment flow rate, it overflows a weir, bypasses the treatment zone and directly discharges through the outlet pipe. This helps to minimize the effects of scour within the treatment region and prevents wash out of retained sediment downstream.

FEATURES

- Developed at inhouse high-flow Hydraulic Rig, and rigorously tested against actual rainfall inlet conditions
- High retention at most frequent rainfall events per annum
- High treatment flow rate to size ratio preventing oversized separators in the drainage design i.e. minimise footprint
- Wide range of chamber sizes (Ø1200 – Ø4000mm) and pipe sizes (Ø150 – Ø900mm)

APPLICATIONS

- SuDS based drainage networks
- Housing Developments
- Retail Parks
- Commercial Centres
- Leisure Facilities

SPECIFICATIONS

MODEL	TANK DIAMETER	MAX TREATMENT FLOW RATE	PIPE SIZE	MIN. SEDIMENT STORAGE CAPACITY	MIN. OIL STORAGE CAPACITY	MAX. HEAD LOSS AT TREATMENT FLOW RATE
	(mm)	(L/s)	(mm)	(m³)	(L)	(mm)
PRE-SC1200	1200	43	300	0.50	320	240
PRE-SC1500	1500	67	375	0.82	630	300
PRE-SC1800	1800	96	450	1.23	1085	360
PRE-SC2100	2100	131	525	1.75	1725	420
PRE-SC2400	2400	172	600	2.38	2575	480
PRE-SC2700	2700	217	675	3.13	3670	540
PRE-SC3000	3000	268	750	4.01	5035	600
PRE-SC3600	3600	387	900	6.20	8703	720
PRE-SC4000	4000	477	900	8.00	11938	800

Notes:

- MTRR is per WRc specified Weighted Annualised Removal Efficiency of at least 50%, for a particle size distribution (PSD) with a D_{50} : 63µm and density of 2650 kg/m³
- Customized solutions such as: oriented inlet, multiple inlets, and different pipe sizes available as required
- Sediment storage capacity could be extended as required, per the desired maintenance frequency

SuDS POLLUTION MITIGATION INDEX (PMI)

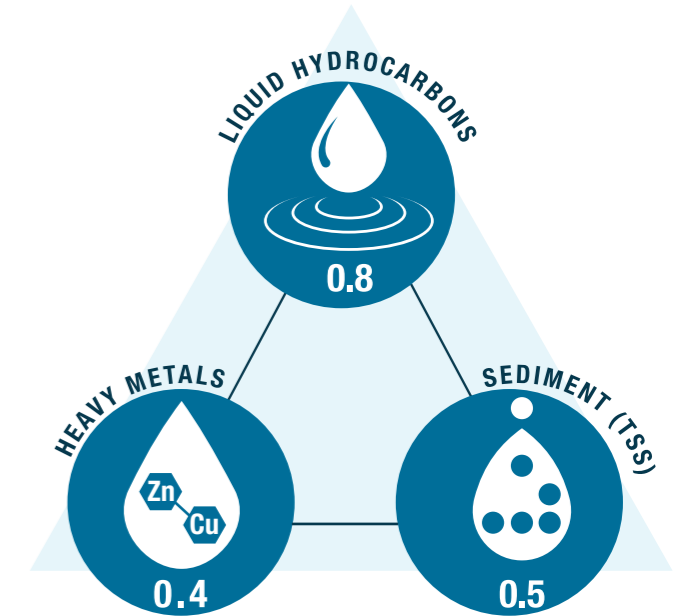

- Tested using extremely fine sand particles starting from 2µm
- Modular and innovative design for multiple inlet orientation
- Choice of flow direction providing optimal configuration performance
- Complies with SuDS legislation

- Industrial Developments
- Highway Drainage Products
- Car Parks, Roads, Motorways and Trafficked Areas
- Existing surface water sewer discharges

STORMCHANNEL™

FP McCann's StormChannel™ is a heavy duty, precast concrete slot drainage channel designed to remove surface water from many areas, including roads, motorways, car parks, industrial, commercial and residential areas. This helps to prevent flooding and run-off.

FP McCann offers two types of StormChannel™ slot drain:

1. A precast concrete bullnosed kerb drainage channel has a linear slot drain and a profiled, oblong drainage channel.
2. A standard precast concrete drainage channel with an interrupted slot and stabiliser bars for increased stability.

PRODUCT BENEFITS

- Quick installation
- Minimal maintenance
- Excellent flow rates even at zero or shallow gradients
- Modular system
- Robust product
- Economical product
- Integrated watertight seal
- No concrete surround required
- Conforms to EN 1433



SCAN THE QR CODE TO SEE OUR STORMCHANNEL™ INSTALLATION VIDEO

RANGE OF SIZES



300 Standard

400 Standard

400 Kerb

500 Standard

600 Standard

CAST IN GRATING



A unit with cast in grating to allow easy cleaning and maintenance

PRODUCT FEATURES

- Resilient up to class D400kN, E600kN or F900kN
- 300 and 400 Standard Stormchannel™ tested to Class E600
- 2% surface slope to the slot
- Supplied with interrupted slot only – slot width 30mm
- Spigot and socket end for correct alignment and joining

Additional connections can be provided on request to this precast slot drain solution. Junction boxes and sump units are also available in all sizes.

HOUSE INSPECTION CHAMBERS

FP McCann's precast concrete inspection chambers are available in two sizes: 600 x 450 and 1200 x 750mm. Manufactured in accordance with BS EN 1917 / BS5911, each section has a tongue and groove joint and can be sealed with a sand and cement mortar or bitumen sealant, in the same fashion as a circular manhole and chamber ring.

To complete the chamber, FP McCann has a range of covers and ground level components. FP McCann's frame (also known as a surround) and lid combination is designed to sit flush with the top course, such as tarmac or concrete surfacing or in grassy areas.

The lid itself features an anti-slip chequered finish and recessed lifting points to allow removal from the frame by use of standard lifting eyes.



Chamber Size (mm)	Cover
600x450	Frame and lid places straight on top of unit
1200x750	Light or heavy duty below surface slab with 600x600 access, allowing use of standard steel access hole cover

Description Units (mm)	**Weight per unit (kg)	No. of units per pallet	Wall/ Slab thickness (mm)
600x450x150 section	40	12	40
600x450x225 section	65	8	40
600x450x300 section	85	6	40
600x450x100 frame	45	8	100
600x450x55 lid	50	16	55
1200x750x150 section	120	6	75
1200x750x250 section	200	4	75
1200x750x80 cover slab (600x600 access)	185	6	*80

* Effective thickness
** Approximate weights

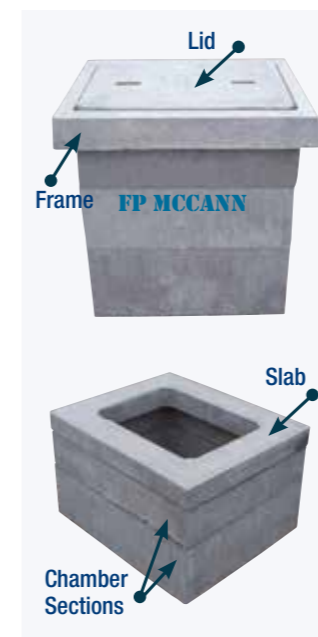

NOTE: For HIC's placed in depths greater than 1.5m, we recommend the use of a concrete surround.

GULLIES & SLABS RANGE



GULLIES

Dimensions (mm)			Nominal Weight (Kg)	Approx. Capacity (litres)	No. per load
Diameter Internal	Depth	Outlet			
375	750	150	180	51	66
375	900	150	200	67	66
450	750	150	215	71	60
450	900	150	255	95	60
450	1050	150	270	118	60
450	1200	150	280	142	60

PRODUCT BENEFITS

- The seal has been cast-in, thus preventing loss or damage on-site
- An integral seal and rodding eye for universal sealing characteristics
- The rodding eye closure has been recessed into the concrete to help eliminate dislodgment
- Reduced thickness, giving reduced weight and a smaller footprint for better vehicle utilisation
- Improved system that helps prevent any discharge of oil
- The gully is fully universal, suitable for all plastic and clay drainage products from 160mm to 186mm diameter
- Does not lose shape
- Does not float (self weight inhibits flotation)

STANDARD GULLY COVER

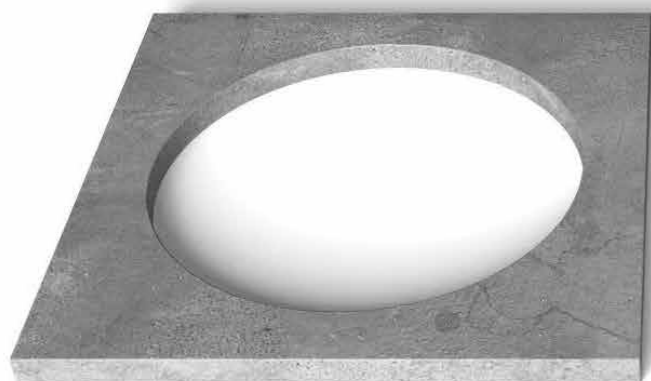

GULLY COVER SLABS

Dimensions (mm)	Standard	Horseshoe	65 Standard	65 Horseshoe
Length (mm)	750	600	750	600
Width (mm)	650	650	650	650
Thickness (mm)	100	100	65	65
Weight (kg)	70	58	51	37
Hole Size (mm)	450	450	450	450
Qty/Pack	12	12	12	12

The Gully Cover Slab is designed as seating for a gully grate

PRODUCT BENEFITS

- Quicker to lay, ensuring reduced labour costs
- Use on top of 450mm diameter gully
- Eliminates laying engineering bricks on-site
- Sits flush to kerb for enhanced stability
- 100mm and 65mm thick single piece units available
- Eliminates brickwork vertical joint 'weakspots'
- Greater stability than brickwork
- Quality product produced by vibration process
- Compressive strength similar to Class B.Eng. bricks

HORSESHOE GULLY COVER

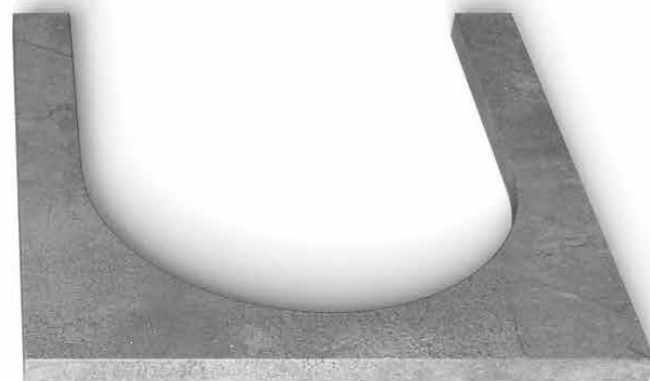

FALL ARREST SYSTEM

AWARD-WINNING SAFETY SOLUTION FOR MANHOLE CONSTRUCTION

Clients, consultant engineers, contractors and suppliers all have a duty to mitigate hazards on-site, whenever reasonably practicable. One such hazard identified is the risk of operatives falling through manhole openings, particularly during the construction process and also in follow-up maintenance work.

Working with partners Severn Trent Water, engineer Grontmij and contractor to the water sector, Morgan Sindall plc, FP McCann has designed an award-winning safety solution. Our fall arrest system allows for safe working around the manhole opening prior to the fitting of the ironwork.

In the construction of a manhole, operatives often work unprotected from the opening at surface level when the final stages of completion occur. This includes the final brickwork up to the manhole frame and the mortar bedding of the frame itself.

With most standard cover slabs, the access point for man entry is open and it is left to the contractor to cover on-site. In many site situations, these openings remain for a number of days while phases of work are completed. Our fall arrest system immediately addresses this problem. The future production of all standard access cover slabs will incorporate the optional protective grid, which will remain in the slab even when the final D400 steel cover and frame are set in place at surface level.

The galvanised mild steel grid is available in four standard sizes:

- 610mm x 610mm
- 675mm x 675mm
- 750mm x 600mm
- 1200mm x 675mm

The fall arrest grid is seated on load-bearing corners cast into a standard range of manhole cover slabs. If a temporary fall arrest system is required, once the construction of the manhole is complete, the grid can be removed prior to the fitting of the ironwork. Alternatively, it can be a permanent fixture, left in place beneath the manhole lid. The spacing between the bars allows for ease of inspection and jetting of the manhole base during maintenance work.

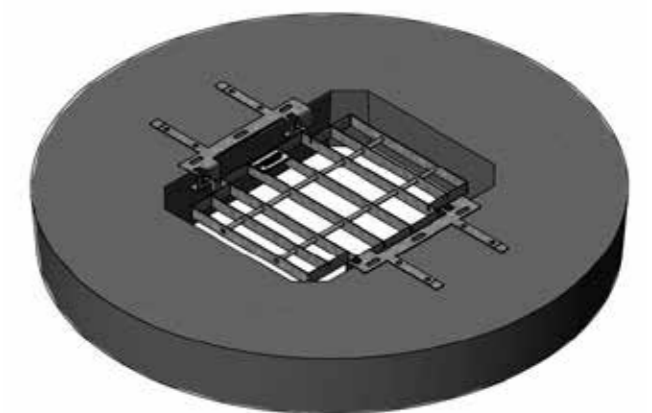

Note: Gullies and Gully cover slabs manufactured in accordance with BS 5911-6

RAIN HARVESTING CHAMBERS

FP McCann's rain harvesting chamber is a bespoke precast water storage chamber that is compatible with water harvesting systems for residential, industrial/commercial and agricultural installations. Capturing rainwater for re-use offers significant cost savings for the user and benefits the environment by increasing water resources and further enhancing water amenity. The chamber complies with Environment Agency SuDS (Sustainable Urban Drainage System) directives.

The basic concept of harvesting rainwater is simple - rainwater is mostly collected from the roofs of buildings - it flows through gutters and downspouts and is then filtered and collected by a storage tank. From the tank, it can be recirculated or treated to produce a better quality of recycled water.



VOLUME CAPACITY OF STORAGE CHAMBERS

Internal Diameter (x1000mm)	Capacity (Litres)	Weight (kg)
DN1800	1200	1800
DN1800	1500	1900
DN2400	3000	5900
DN2400	5000	7250
DN2400	7000	8700



ADD-A-STEP® MODULAR MANHOLE LADDER



ADD-A-STEP® modular ladders are designed to allow easy access to chambers and are approved for use in potable water, waste water, highly corrosive and general construction applications. They are a cheaper, safer and a more user-friendly alternative to traditional stainless steel ladders.

The ADD-A-STEP® modular ladder system is designed to provide a product that can be supplied off-the-shelf for next day delivery. Each module of the ADD-A-STEP® ladder consists of two stiles, one rung and two retaining clips. Each stile measures 360mm long, 80mm wide and 32mm thick maximum dimension. The ladder width outside the stiles (upright) is 435mm.

The ADD-A-STEP® ladder has 30mm diameter rungs at 300mm centre spacing and the width or foot space inside the stiles is 375mm. Two types of wall brackets are supplied as standard, one for circular and one for square chambers. The ladder can be assembled on-site using the number of modules to achieve any length and can be trimmed to length using a standard hand saw without the need for expensive cutting equipment.

ASSEMBLED IN MINUTES STAINLESS STEEL PULL-UPS AVAILABLE TO SUIT EX STOCK

BENEFITS

The modular design allows for more economical transportation than fully assembled ladders. The ADD-A-STEP® ladder requires no maintenance other than occasional cleaning with a pressure hose, if desired. The ladder has excellent insulation properties so it can be used in applications where electrical cables are present. Constructed from polybutylene (PBT), which is UV tolerant, it is a non-corrosive and a fully recyclable material; it can easily be cut on-site with no harmful shards or dust given off.

The ADD-A-STEP® ladder helps to reduce potential health and safety risks. At approximately 5kg per linear metre, the ladder is significantly lighter than galvanized or stainless steel alternatives and its yellow colour gives it high visibility properties, making it clearly visible when the manhole cover is raised. It is also a cheaper and more user-friendly alternative to traditional stainless steel manhole ladders. The ADD-A-STEP® system is fully compliant and tested to BS EN 14396, and is the only CE marked modular ladder system in the UK.



PLASTIC ENCAPSULATED LADDERS & RUNGS

This system ladder gives the user benefits of a durable plastic encapsulated ladder without the need to specify an exact length or fit on-site. In addition, a single specification can be used for all depths of access.

PRODUCT SPECIFICATIONS

BS EN 13101 Plastic Encapsulated Steps

WIS 4-33-01: 1990 Polypropylene Encapsulated Steps

PRODUCT APPLICATIONS

Concrete manholes and inspection chambers.
Renovation of existing structures.

MATERIALS

The plastic encapsulated ladder has a bright yellow coating and is made from high impact virgin polypropylene copolymer plastic. If the ladder is to be subject to prolonged exposure to daylight then black or UV stabilised material should be specified. It is reinforced with structural steel.

PERFORMANCE

- Pull out load:** 7.5kN minimum, when fitted in accordance with manufacturer's instructions
- Deflection under load:** 5mm maximum at 2.5kN
- Permanent Set:** 0 mm at 2.5kN
- Impact:** 20kg weight from 1 metre, no cracking
- Chemical Resistance:** At least pH2 to 12
- Integrity of plastic:** 2M ohm at 500 volts DC
- Thickness of plastic:** 3mm minimum
- Minimum cross section:** 25mm diameter

PRODUCT BENEFITS

- Excellent corrosion resistance
- Visibility
- No sharp edges
- Eliminates need to specify exact length or fit on-site
- Steel reinforcement gives predictable deflection under load without causing brittle failure

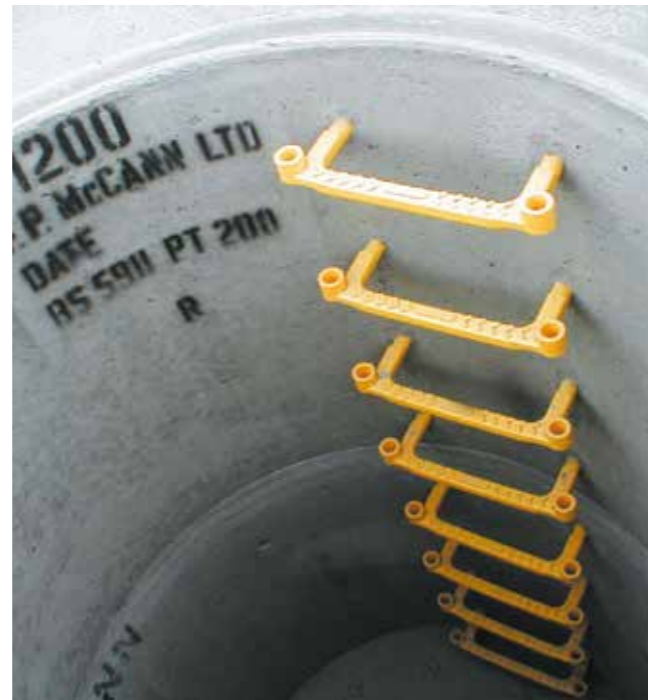

HANDHOLD ENTRY POLE SYSTEM

The handhold entry pole system is suitable for aiding maintenance engineers in the initial entry into a manhole from the surface level. Once fitted, the entry pole is a permanent fixture within the manhole, which is stored in the lowered position beneath the level of the cover. When required, the entry pole can be easily extended by simply hooking the easy-to-reach loop located at the top of the pole, pulling the handle upwards and twisting, locking into position. The handhold then provides a stable support to aid the entrance of the manhole, as well as a clear visual indication of the location of the manhole, when open. This helps prevent injury of other people in the area. Once the engineer has used the entry pole to aid their return to the surface, the pole is simply twisted to unlock it from the raised position and lowered back into the manhole, ready for the next time it is needed.

SPECIFICATION

The handhold has a pole length of 1200mm and can be assembled to give three different distances from the pole to the wall. This is designed to accommodate different cover positions.

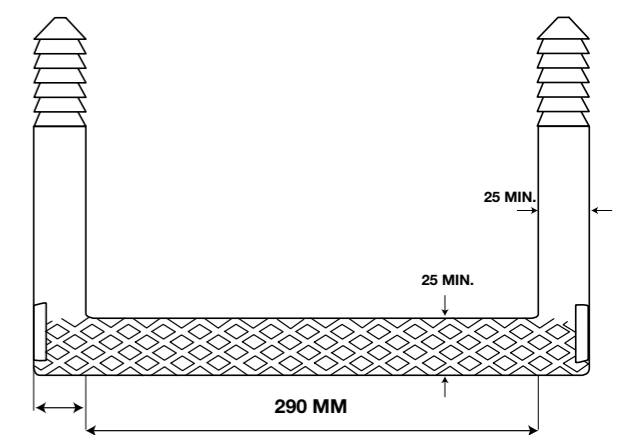
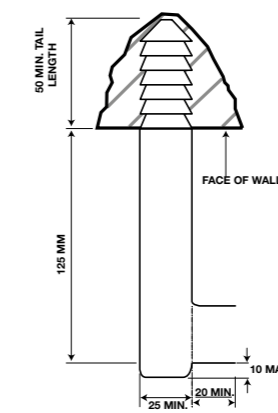
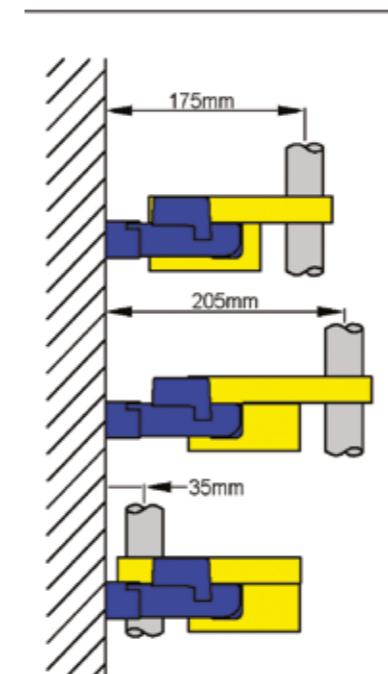

PRODUCT BENEFITS

- Helps the user find the first step safely
- Creates visual aid to indicate location of manhole to other people in the area
- Easy to fit
- Easy to raise and lower
- High strength for ultimate safety
- Low cost
- Can be fitted to any Caswick step
- Two projections for round or flat walled manholes

HEADWALLS

FP McCann's precast concrete headwalls provide an ideal end connection point to outfall pipes into open watercourses such as rivers, culverts, collection and balancing ponds. They are a very efficient alternative to intrusive shuttering of soil embankments and costly on-site formwork with ready-mixed concrete, making them particularly suitable for use in hard-to-reach locations and in environmentally sensitive areas.

Where time constraints exist such as in tidal flow situations, concrete headwalls can be quickly positioned, secured and backfilled, providing immediate stability around the point of water discharge.

The FP McCann headwall range can accommodate pipe sizes from DN150 to DN2100 and is suitable for usage with box culverts. Additionally, accessories such as flap valves, penstocks, silt traps, handrails and safety grating can be added as part of the specification.

A front weir wall can be fabricated onto any of the standard headwall range, on request, and installation is quick and easy.

KEY SITE SAFETY BENEFITS

Safety hand rails can be used with our full range of headwalls. Health and safety risks are minimised because the construction work takes place off-site and installation is quick and easy.

Please note: Bespoke grates and handrails are available on request. Please contact FP McCann for information on correct installation



XL-T4 HEADWALL



SMALL HEADWALL



MEDIUM HEADWALL



LARGE HEADWALL



XXL-T2 HEADWALL



PRODUCT BENEFITS

- Headwalls are designed to EC2 and manufactured to BS EN 13369. (Full design calculations available to illustrate design assumptions).
- Prefabricated off-site
- Speedy and efficient to install
- Durable, long-lasting and low maintenance
- No on-site shuttering or formwork required
- Provides immediate stability and reduces soil erosion
- Valve and safety accessories available
- Cost-effective solution
- Significantly reduces the potential for floating debris to block the watercourse
- Installation with 2 or 3 lifting anchors
- Flap valves and grates available
- Reduces carbon footprint as no need to bring in lorries to site to pour in-situ
- The extended toe unit is available for all sizes making the entire headwall range compliant with Sewers for Adoption (SFA) and Sewers for Scotland
- Headwalls meet the requirements indicated in Fig. C.5 (typical details) of Sewers for Adoption

Headwall Range	Up to & including Pipe Sizes	Max Pipe O.D. mm	Approx. Weight (Kg)
HW Small 100	300	450	1100
HW Small 150	300	450	1390
HW Medium 100	450	630	1540
HW Medium 150	450	630	2020
HW Large 100	900	1080	3020
HW Large 200	900	1080	4740
HW XL-T1	1500	1800	Part A / B 4725
HW XL-T2	1050	1260	Part A / B 4095
HW XL-T3	675	885	Part A / B 3465
HW XL-T4	375	505	Part A / B 2646
HW XXL-T1	2100	2460	Part A / B 10,150
HW XXL-T2	1500	1800	Part A / B 9205
HW XXL-T3	1050	1260	Part A / B 8421
HW XXL-T4	525	675	Part A / B 6915

NB: The above dimensions are in mm.

ACCESSORIES

Please note: Bespoke grates and handrails are available on request. Please contact FP McCann for information on correct installation



TYPICAL FRONT WALL GRATE



TYPICAL BASKET GRATE



TYPICAL HANDRAIL



MECHANICAL CONCRETE PIPE LIFTER

Fit a pipe lifter to your excavator and you can lay concrete pipes in around half the time with less cost and less hassle – but with greater safety.

Safer. No operative needed on vehicle during off-loading or in trench during pipe laying.

Easier. Simple to use. No special equipment & minimal training required.

Faster. Around 50% saving on installation time.

Cheaper. Fewer operatives plus greater productivity.

The Concrete Pipe Lifter makes light work of the installation of waste water pipelines. Within seconds, it can be attached to your excavator using a quick-hitch coupling. There are no hydraulic links or additional energy requirements.

There is no need for anyone to stand on the bed of the vehicle during off-loading (the biggest cause of accidents during pipe laying). There's no need for anyone to stand in the trench during installation and there are no slings or chains to trap hands and fingers. The whole operation is around 50% faster and you can reduce the size of your pipe laying team, so costs are lower too.

The Concrete Pipe Lifter is suitable for standard UK specification BS EN1916 concrete pipes from DN300 to DN1200.

The Manhole Lifter is a companion device that makes lifting manhole rings a safe and easy, one-man operation. It eliminates the risk of vehicle falls during off-loading. There are two versions available for precast concrete manhole rings from DN900 to DN1800 and from DN2100 to DN3000. It's capable of lifting rings from 250 mm to 1000 mm deep.

To buy or rent the Pipe Lifter, contact BPDA's supply partners visit: concretepipelifter.co.uk for details



KNOW YOUR LIFTERS

All of the precast concrete drainage products manufactured by FP McCann feature a lifting system to allow safe off-loading and installation in an efficient manner. Each system is suited to each type of product.



The information below will allow you to determine what lifting attachments are required. This list is not exhaustive and may be subject to change. Please contact FP McCann's technical department if you are unsure about any aspect of lifting. Please be aware that it is the contractor's responsibility to ensure all lifts are safe and compliant with legal requirements.

If you do not have the correct lifting equipment, please contact our sales department who will be happy to assist. **Please ensure you have ordered lifting equipment to arrive on-site, ready for when your load is delivered!**

Unless otherwise stated, FP McCann will only supply the eyes or attachments. Correct chains will need to be sourced by the contractor. Unless otherwise specified, access to the trailer will be required to insert the attachments.

PRODUCT	LIFTERS REQUIRED		NOTES
900 to 1800 Standard Chamber Rings and Soak-away	3No M24 Lifting Eye Pins inserted into holes through the ring wall.		Eyes should be on the INSIDE of the ring.
2100 to 3000 Standard Chamber Rings and Soak-away	4No M30 Lifting Eye Pins inserted into holes through the ring wall.		Eyes should be on the INSIDE of the ring.
3600 Standard Chamber Rings	3No RD30 Lifting Loops screwed into the top face of the ring		Please be aware that the loops are not intended for prolonged use.
4000 Standard Chamber Rings (2 part)	4No RD36 Lifting Loops screwed into the top face of the ring		Please be aware that the loops are not intended for prolonged use. Instructions for handling are shown on the product itself.
1200 to 1800 Wide-Wall Chamber Rings	3No 5t Spherical Head Clutch		Attach to the OUTSIDE of the ring.
300 to 1200 Standard Pipes and Fittings	Pipe Grab (below) or Slings		Slings are <u>not</u> supplied by FP McCann. DO NOT USE HOOKS! These can damage the pipes and can be dangerous!
1350 to 2100 Standard Pipes and Fittings	10t Spherical Head Clutch and Chain Sling Set		Clutches and chains allow safe lift and easy installation of units.
2400 Standard Pipes and Fittings	20t Spherical Head Clutch and Chain Sling Set		12-20 tonne shackle 2 leg lifting chain only
All Diameters of Standard Cover Slabs	None		Chain Hooks can be attached directly to all of our standard slabs without further equipment required.
Small Headwalls	2 No. 24mm Lifting Loops		Please be aware that the loops are not intended for prolonged use. Instructions for handling are shown on the product itself.
Medium & Large Headwalls	3 No. 24mm Lifting Loops		

MECHANICAL GRABS - The quicker, easier and safer option for handling rings and pipes. These attachments connect to site plant and allow off-loading and installation without any need for access to the trailer bed. Mechanical grabs are available for pipe diameters DN300 to 1200 and for ring diameters of DN900 to 3000. For further information, contact your sales representative. Easi-bases, headwalls and flow-control chambers come supplied with the correct lifters ready for use. Catchpits should be handled with a mechanical grab. All lifters supplied by FP McCann come with appropriate certification and are ready for use. Lifters should be incorporated into the contractors lifting equipment inspection regime under LOLER regulations or disposed of after use.

SAFE LIFTING OF STANDARD PRECAST CHAMBER RING SECTIONS

When lifting chamber ring sections with lifting eyes, it is important that the eyes are passed from the inside of the ring and the nut is attached to the outside of the ring to secure the pin. Hooks must be attached to the eyes on the inside of the chamber and lifted in a safe and controlled manner.

Lifting with the pins installed in any other way is dangerous and should not be attempted in any circumstances.

Lifting with the eyes on the outside is NOT safe and can crush the concrete section. When using lifting eye bolts with the nut not attached, the ring can become damaged or the eyes can pull out of the concrete.

Please be aware that precast concrete rings are fragile. They have thin walls and are not reinforced, and can be easily broken when handled incorrectly.



Eyes passed through from the outside with hooks connected to the outer face of the ring. Pins can come loose if nuts not applied or the self-locking mechanism has not engaged and the concrete can be crushed by the chains.



Eyes passed through from the inside with the plate and nut applied to the thread on the outside, or self-locking mechanism engaged. Hooks are connected to the inside of the ring to allow for a safe lift with straight chains.

For safe lifting in situations when access to the product is restricted (i.e. when stacked high or on a trailer bed, a mechanical grab should be employed). Wide wall chamber rings are lifted via a different method (see page 18).

Bespoke chamber components such as Easi-Bases™ and StormBrake™ Flow Control Chambers will feature a separate handling method. Reference should be made to appropriate drawings or handling information.

STORMSTORE™ RANGE OF TANKS & CHAMBER SYSTEMS

FP McCann's Stormstore™ range of precast tank and chamber systems is the most extensive in the UK. Products manufactured include StormTank™ bespoke precast concrete panel system, StormChamber™ bespoke precast concrete chamber system, a precast concrete storm and waste water management system called Modular Tank System and StormHold™ stormwater management system. Complementary products include StormCleanser™ hydrodynamic separator, StormBrake™ vortex flow control system and StormChannel™ heavy-duty precast concrete slotted drainage channel.

KEY ADVANTAGES OF OUR RANGE

- From receiving the specification, designs can be returned within 2 days
- Complete design package provided, including calculations and drawings
- Manufactured off-site, including factory-fitted pipework and flow control connections, ensures consistent quality, lower construction costs, faster installation and lower health and safety issues
- Design service life of 100 years
- Overall cost of the project can be estimated no matter how complicated the design
- Bespoke designs can be used for reproductions and for future alterations
- No vertical shuttering required, unless an in-situ floor is installed
- Complies with all relevant British Standards and Eurocodes



PARAMETRIC DESIGN

ONE DESIGN FOR ALL STRUCTURES

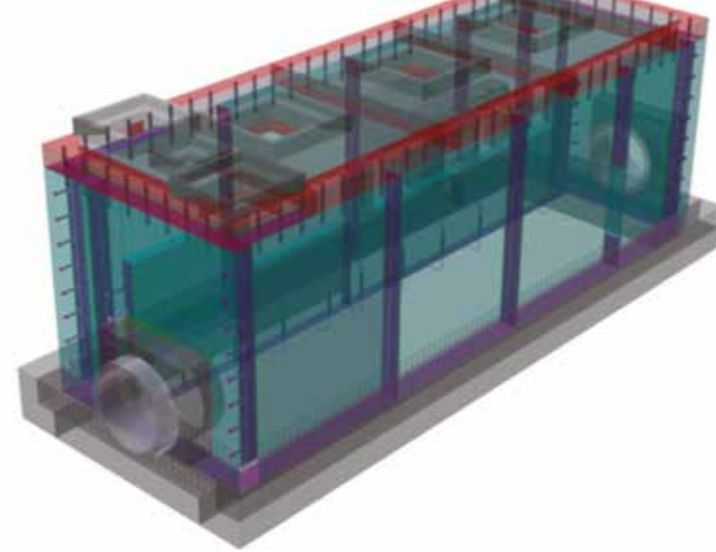

FP McCann's precast tank and chamber systems are designed using parametric 3D modelling. Specification details such as length, width, depth and loading category are entered into our in-house system by our design team; along with additional options such as pipe entries, which will instantly produce the drawings, schedules, price etc.

All multi-purpose chamber and panel systems are designed to BS EN 1992 and are CE marked.

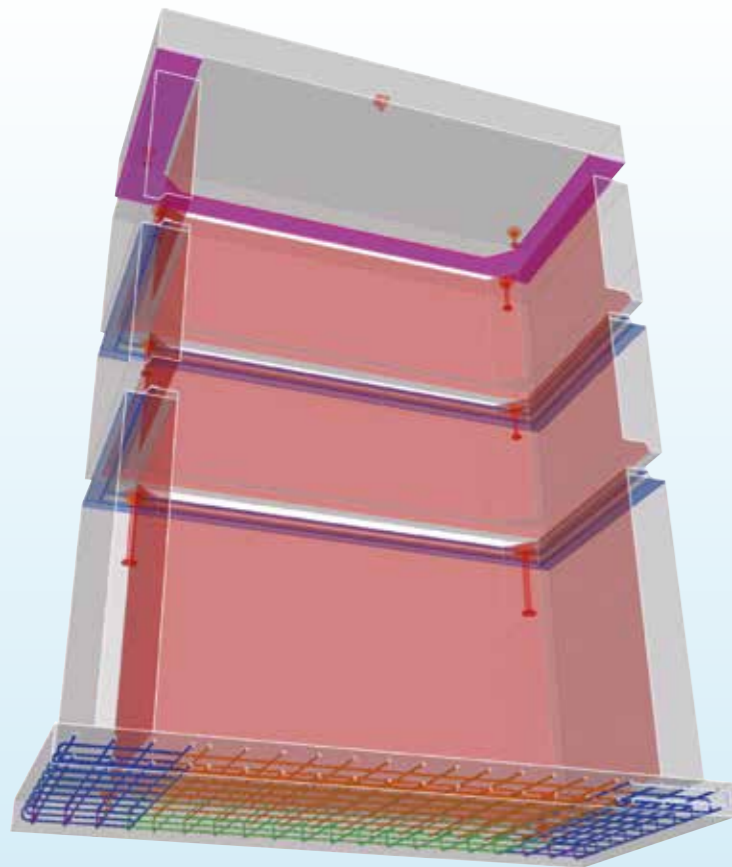

THE DESIGN PROCESS...

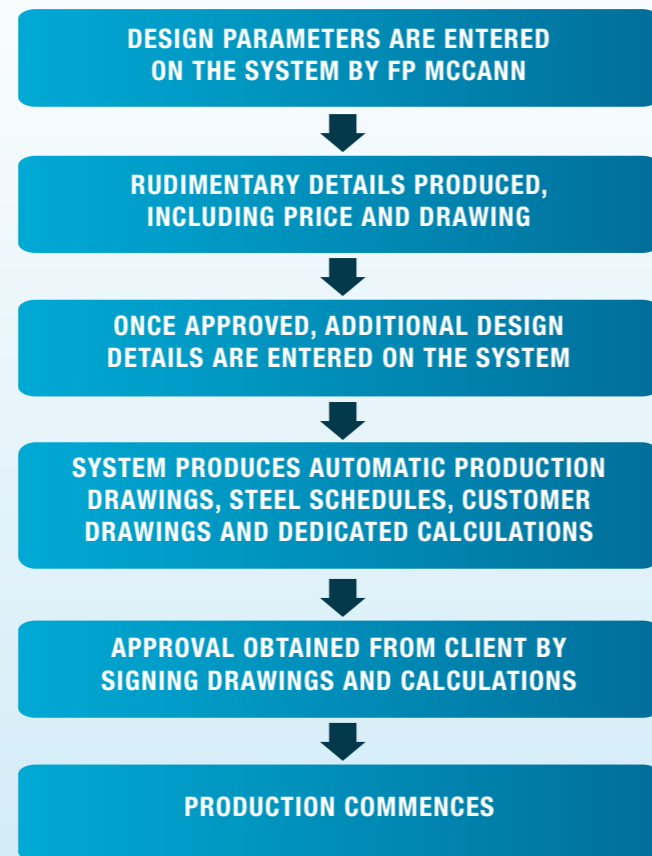

STORMCHAMBER™

MULTIPURPOSE CHAMBER SYSTEM



FP McCann's StormChamber™ multipurpose chamber system is a single piece chamber system made up of a base unit, risers and cover slab to suit chamber depth and the specific application. A 3D dimensional drawing is available on request. This flexible modular system is suitable for most tank and chamber applications.

STORMCHAMBER™ – INTERNAL DIMENSIONS

1250 x 1250mm	2500 x 2000mm
1500 x 1500mm	2500 x 2500mm
2000 x 1500mm	3000 x 2500mm
2000 x 2000mm	3000 x 3000mm

The above size range do not generally have toe units.

Sizes above 3000x3000mm up to a maximum size of 5000x3500mm. The length and width of these chambers can be adjusted up/down in 250mm increments to suit requirements. The height of the chamber is flexible up to 6 metres, with 8 metres possible, subject to calculations.

If chamber dimensions are critical and don't fit with the above range, we can usually offer a solution.

TYPICAL CONSTRUCTION/ INSTALLATION

(Subject to specific application)

- Base unit is placed on level concrete blinding or type 1 sub base
- Riser unit/s are placed onto the base unit, if required
- Hydrophilic swell, butyl sealant and bearing strips are placed in the joint between the base unit and riser unit/s
- Internal wall is fitted at factory or at site and is connected with threaded rod, nuts and washers
- Pipework is connected and backfilling takes place
- Cover slab is bedded on with high strength mortar, contained to the inside by butyl sealant strip

You should consider the overall installed cost of the chamber when taking into account all the benefits and cost savings detailed below, not the upfront material cost.

BENEFITS

- Concrete surround is not required, saving time and money on site installation. Up to 85% reduction in on-site construction programme
- Pipe penetrations are done at the factory, avoiding the need for cutting or core drilling on site
- Weir walls, flow controls etc can be factory fitted, if required. Up to 95% reduction in site man-hours for pit construction
- Virtual elimination of on-site waste
- 55% reduction in lorry movements for deliveries
- Traffic calming/ management reduction
- Elimination of need for confined space working
- Significant reduction in site noise
- Clear openings to suit requirements
- Reduces enclosed spaces work and working at depth
- Reduction in Health and Safety and Dynamic Risk Assessment issues
- Enhanced functionality - product can be designed for future alterations
- A flexible modular system with a high quality factory finish
- Greatly reduces long term maintenance costs
- Smaller units may be adjusted using alternative increments, if required



STORMTANK™

MULTIPURPOSE PANEL SYSTEM

The StormTank™ multipurpose panel system is an underground structure consisting of wall panels, an in-situ or precast concrete base and cover slab, which are assembled on-site by the contractor or an approved installer using a range of standard jointing types. The panels can be made with cast-in pipe connections, recesses and openings and have penstocks or flap valves pre-installed. Internal weir-walls, overflows, underpasses and baffle walls can also be incorporated into the structure.

This system can be used for a variety of uses such as CSO chambers, storage tanks, large size manholes, pumping stations, valve chambers etc. The main advantage of using this system is that there is no size limitation, except for the height, which cannot exceed six metres, with a two metre overburden. A detailed installation guide is available. Please contact FP McCann for further details.

PRODUCT APPLICATIONS

- Air-infiltration chambers
- Hydro-brake chambers
- Large CSO chambers
- Water storage tanks
- Pumping stations
- Attenuation tanks
- Large manholes
- ASP structures
- Sludge tanks
- Basements
- Headwalls



MODULAR TANK SYSTEM



StormStore (storm and waste water management system) provides a multifunctional, durable solution for the detention, retention, infiltration, harvesting and treatment of water, comprising of a combination of standardised precast concrete elements, which are designed to solve your storm and waste water management needs.

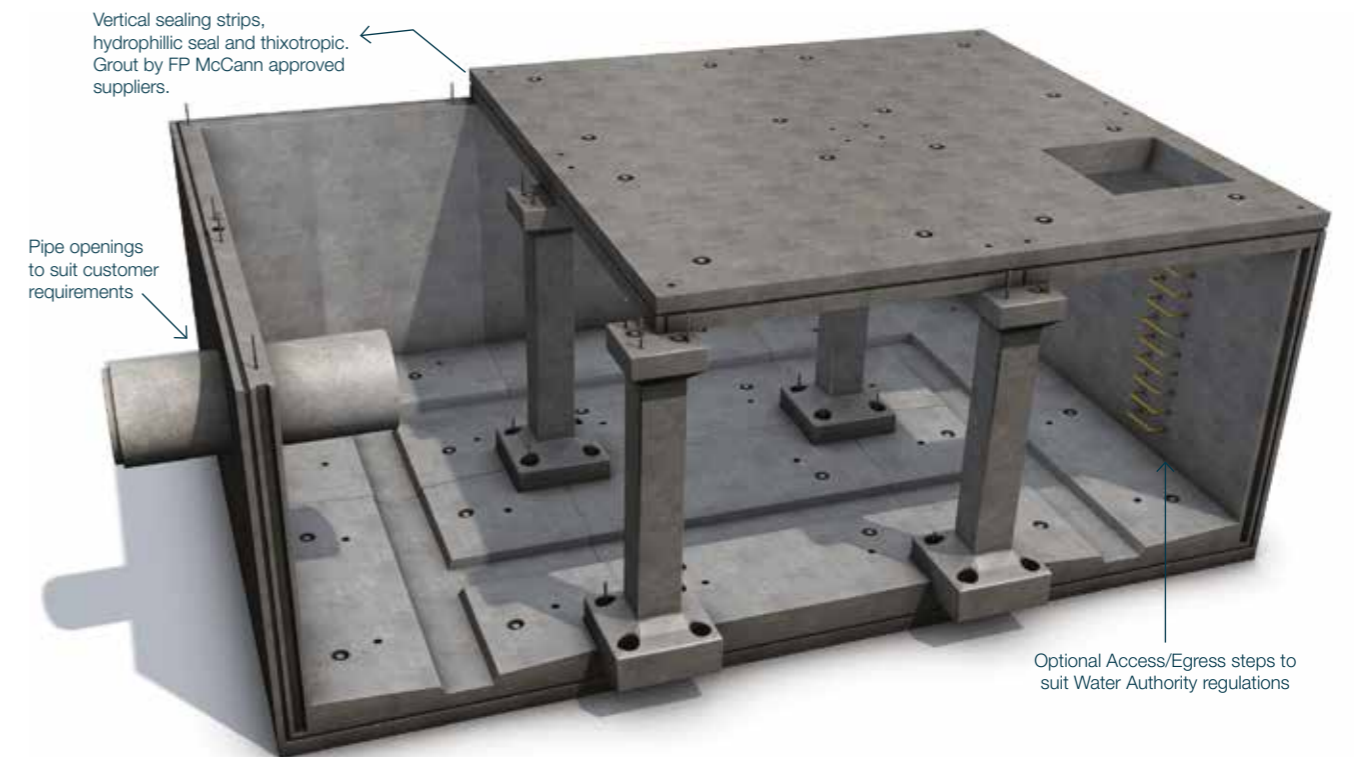

DETENTION

StormStore™ provides a cost-effective solution for site applications where stormwater needs to be detained and allowed to discharge at a controlled rate.

RETENTION

StormStore™ retention systems are ideal for applications where the goal is to retain rainwater or stormwater for some type of harvest and reuse applications.

INFILTRATION

Eliminate the issues created with discharging stormwater off-site by using a StormStore™ to infiltrate stormwater into the soil for natural treatment and to replenish local aquifers.

HARVESTING

Water harvesting is the collection, storage, cleaning and recycling of stormwater to replace or reduce the consumption of municipal potable water.

TREATMENT

Stormwater treatment options such as pre-treatment, post-treatment and oil water separators are available as stand-alone systems, as well as integration with StormStore.

BENEFITS OF MODULAR TANK SYSTEM

MANUFACTURING BENEFITS

- Manufactured locally
- Bespoke inlets and outlets
- An adoptable system which can cater for the 1 in 30 and 1 in 100 year storm event
- FP McCann uses state-of-the-art tooling to manufacture products of the highest quality
- A fully modular system encompassing inherent health and safety benefits

MAINTENANCE AND CLEANING BENEFITS

- The StormStore system excels where most other systems fail, incorporating features that provide maximum system performance and life cycles. As with all stormwater systems, inspection and maintenance of the StormStore system is vital for satisfactory performance and extended life cycle of the stormwater management system
- A self-cleansing and easy maintainable system which includes silt collection areas
- Designed to create safe walking channels during the maintenance, cleaning and inspection process
- Easily inspected visually, offering reduced inspection costs
- System provides clear lines of sight to aid health and safety during maintenance and cleaning

DESIGN BENEFITS

- Complies with BS EN 1992
- Grated inlets may also be incorporated to accommodate surface stormwater flows directly into the StormStore system, reducing the requirements for conventional site drainage components. Any grated inlets may also include pre-treatment devices for pollutant removal
- Standard units reduce design cost
- No requirement for in-situ structural topping to roof slab – offering reduced fill depths and cost savings
- Fully accessible system with the option of including step rungs or ladders
- A fully modular system that brings with it inherent health and safety benefits
- The design and performance meets CESWI 7th edition
- Standard internal heights from underside of roof slab to the channel inverts of 1500, 1800, 2100 and 2400mm. All available with either 1 in 4 or 1 in 20 benching gradients
- The system fully meets CE Marking requirements
- The system and installation is approved by WRc
- Complies with Sewers for Adoption 7th edition and Sewers for Scotland 3rd Edition 2015

- Precast elements manufactured using concrete with a DC4 design chemical class in accordance with BRE SD1
- Up to 2.5m overburden with a 10kN/m2 surcharge
- 100 year design life
- Complies with watertightness class 1 of BS EN 1992-3
- Assumed water table at roof slab level
- Suitable for use within wastewater and stormwater drainage systems

INSTALLATION BENEFITS

- Potential savings on temporary works
- Reduced disruption due to speed of installation
- No need to wait 28 days before back filling. Backfilling can follow on after installation
- No requirement for in-situ concrete topping to roof slab
- No requirement for on-site in-situ benching
- No requirement for in-situ joint-stitching



STORM-HOLD™

LARGE DIAMETER PIPE STORMWATER MANAGEMENT SYSTEM

The production of water-impermeable surfaces in construction is inevitable. This includes roof areas on buildings, car parks, loading bays and road pavements. The provision of these surfaces interrupts the natural drainage process, creating increased stormwater run-off in respect of both volume and flow rate.

In many cases, this increase in stormwater flow and volume is a problem as the local sewer or watercourse does not have the sufficient capacity to cope. This problem could be alleviated by an increase in the size of the stormwater sewer or watercourse, thus providing the capacity within the drainage system to cope with the increased surface water. This, however, may be expensive, cause major infrastructure disruption, and can often be completely unfeasible.

Legislation under Planning Policy Statement 25 and Building Regulations approved Document H3 for flood risk assessment (SuDS), has created the need for planners and developers to design and install effective stormwater management systems.

The types of systems that can be employed to overcome these issues are well documented and varied. Quite often they can be very technically demanding in their operation, maintenance and construction. The selection of a system will depend on site constraints, position, expected loading, geographical limitations and inevitably cost.

The Storm-Hold system offers a complete solution to the stormwater attenuation problem and utilises a tried, tested and approved method of stormwater storage. FP McCann can provide the complete package of design, product specification and supply of products and installation advice.

PRODUCT FEATURES

- Available in a range of sizes
- Can use and combine a number of techniques and products such as pipes, culverts, tanks, manifold systems and soakaways
- A complete solution with all connections
- Established and familiar products
- Can be laid in short lengths
- The system can be adapted to load-bearing and non-load bearing applications
- 120 year design life
- Adoptable by water companies
- Manufactured in accordance with a BSI accredited quality management system conforming to ISO 9001
- Available straight from stock



STRUCTURAL

The inherent structural strength of concrete is well documented and can be designed to meet the severest of loading criteria.

Storm-Hold systems can be tailored to suit low load situations, for example, when the tank is to be situated below verges or gardens.

BENEFITS

- System can be designed specifically to suit the application
- Quick construction using a standard joint
- No need for fabrication on-site or external specialist contractors
- Straightforward installation using known techniques, no need to retrain
- Can be installed under roads and car parks
- Can cope with construction plant loading
- Flotation is not a concern – no need for geotechnical anchors when located below the water table
- Long term solution

DESIGN

The design of the system can be tailored to suit most structural and hydraulic criteria.

RELEVANT LEGISLATION/ INFORMATION

- Planning Policy Statement 25 (PPS25) December 2009

- Department of Communities and Local Government (DCLG)
- Future Water February 2008, Department for Environment, Food and Rural Affairs (DEFRA)
- The Pitt Review, Learning Lessons from the 2007 floods by Sir Michael Pitt
- The Code for Sustainable Homes February 2008, Department for Communities and Local Government (DCLG)
- The SuDS Manual 2007, CIRIA C697
- Sustainable drainage systems - Hydraulic, structural and water quality advice 2004, CIRIA C609
- Flood and Water Management Act 2010

FP McCann's Storm-Hold systems can be designed to suit a wide range of construction projects and drainage schemes. Precast concrete attenuation components include products such as side entry manholes, stop end bends and spigot and socket end wall pipes. These products

can either be engineered into an on-line sewer pipe system or utilised off-line as single or multiple stormwater holding tanks. All FP McCann storm attenuation products comply with the requirements set out within 'Sewers for Adoption 7th Edition' and are made from Kite marked precast concrete components, which comply with the relevant Standards: BS EN 1916 / BS 5911-1 and Manholes BS EN 1917.

STORM-HOLD™

LARGE DIAMETER PIPE STORMWATER MANAGEMENT SYSTEM

EXAMPLES

Spigot and Socket Tank End Wall Pipes (Adaptor/Fitting - BS EN 1916)

- Consists of a standard 2500mm long flex pipe with a cast-in end wall. Inlet/outlet holes are generally cored into the wall

Side Entry Manholes (Junction - BS EN 1916)

- Entry shafts factory-fitted to pipes 900mm diameter and above
- Ideal for use in restrictive locations where conventional manhole build is not possible
- Can be supplied in left or right hand configuration. Access steps can be fitted, if required
- Can be used in conjunction with an end wall pipe
- Additional chamber sections or a reducing slab can be used to build height

Stop End Bends (Bend - BS EN 1916)

- Tank end access for pipes 900mm diameter and above
- Access steps fitted, if required
- Drainage inlet/outlet holes cored, as requested
- Additional chamber sections or a reducing slab can be used to build height

Side Entry Manhole with Bend (Junction/Bend - BS EN 1916)

- 2500mm long Easi-Flex standard pipe with cast-in bend
- Entry shaft fitted to pipes 900mm diameter and above

Mid Entry Manholes (Junction/Bend BS EN 1916)

- Standard pipe with a sealed manhole joint, complete with fitted slab
- Manhole joint and slab factory-fitted to pipes 1200mm and above

- Access to the tank via winch or removable ladder. Reduced access via slab, available on request
- Additional chamber sections or a reducing slab can be used to build height

End Entry Manholes (Junction - BS EN 1916)

- Standard pipe with a sealed manhole joint, fitted slab and cast-in end wall
- Manhole joint and slab factory-fitted to pipes 1500mm diameter and above
- Drainage inlet/outlet holes cored, as requested
- Access steps factory-fitted, if required

PRODUCT BENEFITS

1. Flexibility of design - adaptable to meet client requirements
2. Products can be used in space restrictive on-line sewer systems, providing the required storage volume
3. Reduction in construction times
4. Quality assured and kite marked products used
5. Sustainable systems with design life in excess of 100 years
6. Site safety benefits related to reduction of man hours spent in excavation
7. Ease of access for maintenance
8. Can be linked to other SuDS related systems such as rainwater capture and re-use

Note: Concrete haunching should be used to provide local stiffening to the concrete pipes with manhole entries. Use a minimum 150mm thickness surround to the pipe, extending to a height of 300mm above the pipe, in order to support the shaft joint.

DRY WEATHER FLOW CHANNELS

Prefabricated dry weather flow channels for pipes and box culverts are available. Half round (or equivalent) channels can be cast into the floor of the units at any position, with a choice of equivalent half round diameters.



BOX CULVERTS

TYPICAL CULVERT

Units are available in internal span sizes from 1000mm to 6000mm and internal heights from 500mm to 3600mm, with unit lengths to a maximum of 2000mm, dependent on final mould configuration (please refer to internal dimensions chart opposite).



DRY WEATHER FLOW CHANNELS

Half round (or equivalent) channels can be cast into the floor of the units at any position, we offer a choice of equivalent half round diameters.



BENCHING

Combined with either a channel or cast as a "vee", benching improves self-cleansing flow rates.



MAMMAL LEDGES

Cast-in mammal ledges allow access through the culvert to wildlife without the requirement for extra site provisions.

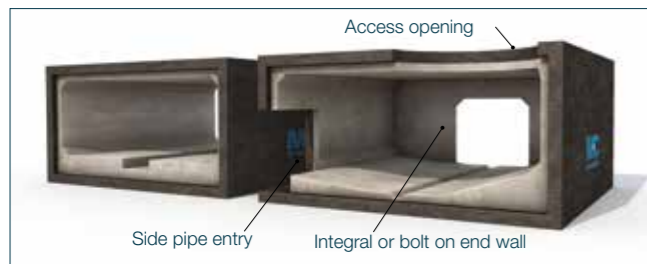

SPECIALS

Bespoke units accommodating a variety of features can be manufactured to our customers' design requirements.

The proven strength and performance characteristics of precast concrete box culverts, together with their excellent service life, make them ideal for a wide variety of civil engineering and construction applications. Box culvert sections can be manufactured in a variety of internal profiles and sizes, offering exceptional versatility in the uses to which they can be applied.

In addition to the more common use for diverting water courses, box culverts have been used in an array of applications including balancing tanks, pedestrian subways, access shafts, service tunnels, sea outfalls, road crossings and many other situations where the whole life costing consideration requires strength, durability and economy to be of paramount importance.

Unlike other materials such as steel, precast concrete box culverts do not require additional treatments to prolong their life or improve performance. The concrete surface will not rust and the smooth internal finish of the box culvert ensures optimum flow of water through the concrete structure.

Precast concrete box culverts fulfil the current design life requirements for buried structures. With minimum maintenance and the ability to provide many years of service, precast concrete box culverts are the most cost-effective means of diverting water courses, especially with the ever present risk of corrosive elements in the water or soil.

Whilst the methods and procedures for the installation of precast concrete box culverts are familiar to contractors, careful attention to detail will lead to safer working, a smoother flow of operations and a higher standard of finished culvert. Box Culvert installation and jointing details can be downloaded from www.fpmccann.co.uk/box-culverts

This guide provides a reliable checklist for anyone engaged in the installation of box culverts. It is published to encourage good practice in the use of precast box culverts.

INSTALLATION GUIDELINES

For installation and jointing details, refer to the Box Culvert Installation Guide which can be downloaded from our website.

DESIGN CRITERIA

Design loading criteria is generally specified by the scheme engineer and ideally should include, as a minimum, the information below:

- Internal span
- Internal height
- Metres required
- Number of runs
- Minimum depth of fill over the culvert unit
- Maximum depth of fill over the culvert unit
- Culvert usage
- Surface loading conditions : green field, highway etc
- Invert type

Exposure conditions should be specified and, where available, design codes provided. Further design requirements may be required for inlet/outlet points, access holes and end walls.

PORTAL FRAMES



Portal frames either consist up of an n-shaped upper unit and two L-shaped footings per ring, or simply just an n-section. The portal frame system offers a quicker and more economical alternative to bridge beams and abutments that are cast in-situ. Units can be designed for specified loadings, and fulfill Eurocode requirements.

KEY FEATURES

- Alternative to bridge beam construction
- Ball and socket joint between wall and roof
- Designed per project requirements
- Reduced insitu works
- Used for road infrastructure
- Bitumen coating can be factory applied if required



UAN culverts consist of two U-shaped sections, which can then be assembled on-site. A ball and socket joint is used between the two parts of the finished section. This option can be offered for larger box culverts that are unsuitable for transport as a monolithic structure or if there are any site specific weight constraints.

The popularity of UAN culverts is growing, largely due to their immediate stability, quick installation, and the flexibility in being able to manufacture culverts for a wider range of applications. Key uses include as an underbridge for road or rail, and in other road infrastructure projects.

KEY FEATURES

- Adjustable moulds mean the product can be made to accommodate a range of projects
- Instant stability
- Mammal ledges can be added to allow wildlife to safely pass through the culvert
- The ball and socket joint is typically located mid-height.
- Used for road infrastructure
- Bitumen coating can be factory applied if required

UAN CULVERTS



**ELLISTOWN OFFICE:**

Whitehill Road
Ellistown
Leicestershire
LE67 1ET
T 01530 240000
sales@fpmccann.co.uk

MAGHERAFELT OFFICE:

16-18 Quarry Road
Knockloughrim
Magherafelt
BT45 8NR
T 028 7954 9026
sales@fpmccann.co.uk

DRAINAGE

Ellistown 01530 240000 (England/Wales) Magherafelt 028 7954 9026 (Scotland)

AGRICULTURE

Lydney 01594 847500 Grantham 01476 562277

BOX CULVERTS

Weston Underwood 01335 361269

BUILDING PRODUCTS

Cadeby 01455 290780

DOCK LEVELLER PITS

Weston Underwood 01335 361269

FENCING

Cadeby 01455 290780

FILTER BED SYSTEMS

Littleport 01353 861416

FLOORING

Weston Underwood 01335 361269 Uddingston 01698 803300

POWER & INFRASTRUCTURE

Littleport 01353 861416

PRECAST OFF-SITE BUILDING SOLUTIONS

Byley 01606 843500 Grantham 01476 562277 Littleport 01353 861416

RAIL

Littleport 01353 861416

SPECIALIST PRECAST

Littleport 01353 861416

TANKS & CHAMBERS

Littleport 01353 861416

TUNNELS & SHAFTS

Cadeby 01455 290780

WALLING

Grantham 01476 562277 Lydney 01594 847500
Uddingston 01698 803 300 (Scotland)

FPMCCANN.CO.UK