

# SOQ2 SHXAR C

## SONIQUE Shower Range Sonique2 Thermostatic Surface Mounted Shower Valve with Adjustable Riser Chrome



### Features:

- All in one box - pack includes shower valve, hose, hose retainer, adjustable riser rail and a rub-clean anti-limescale multi function handset so nothing to buy separately
- Easy installation with adjustable elbow inlets which enable you to use on existing pipework centres between 110mm and 155mm so there's no need for retiling
- Adjustable fixing brackets on riser rail enables existing screw holes to be used
- A hard-wearing, flawless, scratch resistant chrome finish that lasts for years. Salt spray tested to ensure added durability.
- Thermostatic cartridge with preset temperature safety stop at 41°C for family-safe showering. A higher temperature can be selected, if required, by selecting the override function.

### Product Certifications:



WRAS Certificate No: 240403011  
WRAS Expiry Date: 30/04/2029

TMV2 Certificate No: NSF2126/0619  
TMV2 Expiry Date: 13/06/2024



### Specification

Finish/Colour:	Chrome Plated
Main Construction Material:	Brass
No of Controls:	1
Shower Type:	Sequential Mini Valve
Shower Head Type:	Single Function Handset
Shower Kit:	Adjustable Riser
Valve/Cartridge Type:	Thermostatic Cartridge
Maximum Hot Water Supply Temperature °C:	65
Plumbing System Suitability:	Suitable for all plumbing systems, ideally balanced
Minimum Dynamic Pressure (bar):	0.1
Maximum Dynamic Pressure (bar):	5
Maximum Static Pressure (bar):	10
Connection Inlet:	15mm Compression
Connection Outlet:	G 1/2"
Isolation Valve Included:	No
Check Valve Included:	Yes

### Dimensions (measurements in mm)

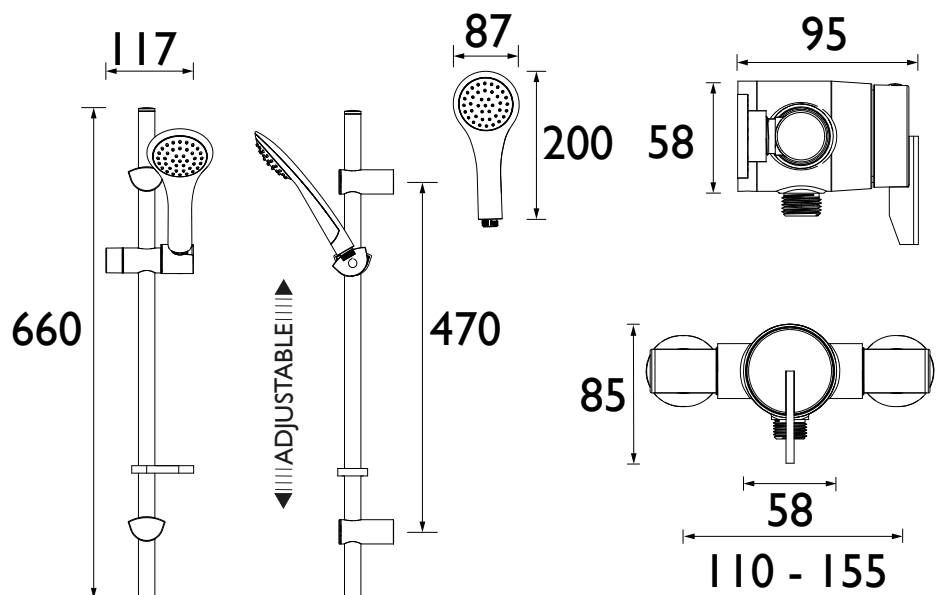

### Flow Rates (l/min)

System Pressure (bar)	0.1	0.5	1	2	3	5
Valve Only/Largest FR (mixed)	2.1	5.4	8	12.1	15.3	21.3
Through Handset (mixed)	2.1	5.4	8	12.1	15.3	21.3
With Flow Limiters (mixed)	1.6	4.1	6	7.9	8.4	8.6

# TECHNICAL DATA SHEET



# BRISTAN

D11