

BETTER BY
DESIGN

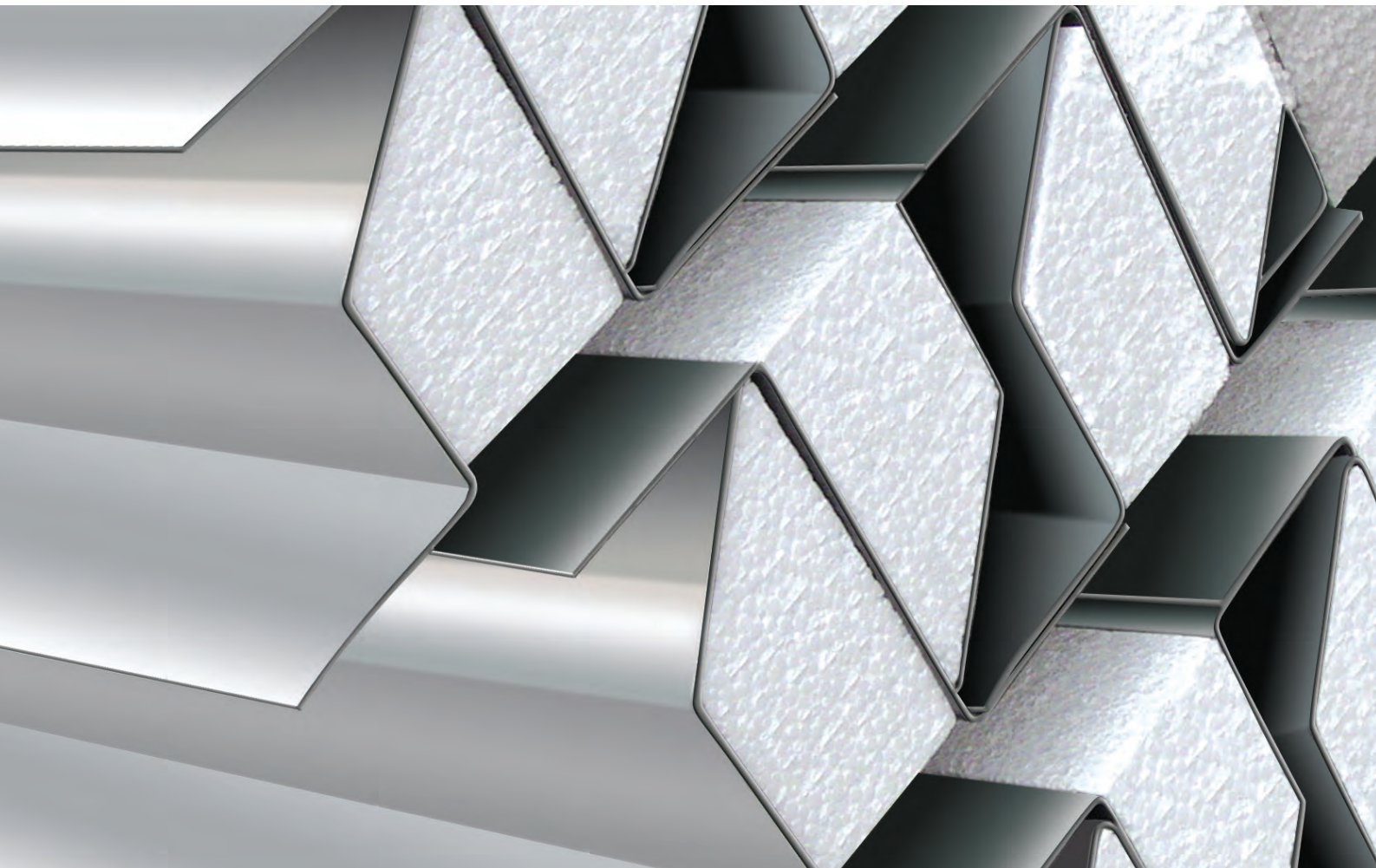

PRODUCT GUIDE

COMPLETE GUIDE TO THE IG PRODUCT RANGE





BETTER BY DESIGN

IG produces the UK's largest range of steel lintels backed by industry leading technical support and ex-stock delivery service.

CONTENTS	PAGE
IG Service	04
Lintel Performance	05
Installation	06
Selecting the Correct Lintel	07
Lintel Range Index	08
Hi-therm+ Lintel	10
Standard Cavity Wall Lintels	12
Wide Inner Leaf Cavity Wall Lintels	19
Wide Outer Leaf Cavity Wall Lintels	29
Eaves Lintels	37
Poro-Cav Lintels	38
Timber Frame Lintels	40
Single Leaf Lintels	43
Box Lintels	44
Solid Wall Lintels	48
Extended Range	50
Stainless Steel Range	53
Lintel Specials	54
Sun Lounge Lintels	60
Brick Slip Feature Lintels	66
Masonry Support Systems	72
Windposts	74
Signature Projects	76
Cavity Trays	83



BBA Certification



British Standards Institution
ISO 9001 & ISO 1400



Builders Merchants
Federation



Investors in People
Accreditation



Building Research
Establishment



RIBA CPD
Approved



Home Builders
Federation

IG produces more than just steel lintels. Our range of specialist products is designed to meet the needs of even the most complex project.



STANDARD LINTELS

IG produces a wide range of standard galvanized steel lintels. All IG standard lintels satisfy the thermal performance requirements of all UK building regulations.

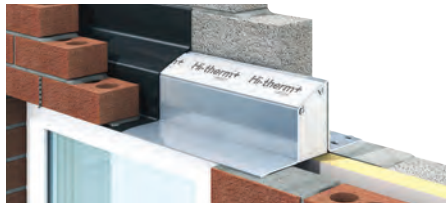

HI-THERM+

IG has redefined lintel performance with Hi-therm+, the low cost solution to reduced carbon emissions and improved Fabric Energy Efficiency (FEES).



STAINLESS STEEL

IG's full range of lintels is also available in stainless steel, providing the same high quality and performance features as standard galvanized lintels.



SPECIAL LINTELS

IG offers a complete custom design service to ensure your project has the best lintel for the job. Our technical expertise is renowned for value engineering the optimum solution.

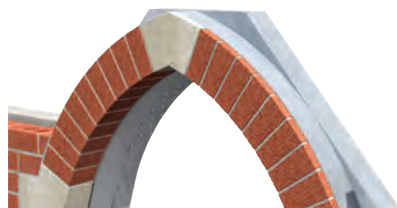

BRICK SLIP FEATURE LINTELS

IG Brick Slip Feature Lintels are one piece, prefabricated units with factory applied brick slips. Units are manufactured bespoke to order and can achieve even the most challenging architectural designs.

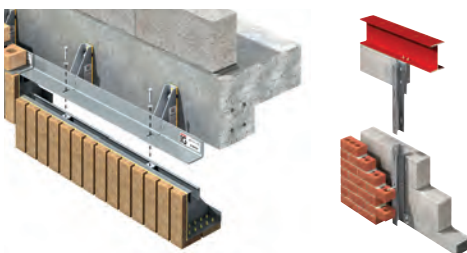

MASONRY SUPPORT & WINDPOST SYSTEMS

IG continues to set the standard for masonry support and windpost systems for a range of building frame configurations. The innovative IG Masonry Support range provides a versatile solution when masonry support is required.



CAVITY TRAYS

The IG Cavity Tray presents a lightweight, simple to install and long lasting solution to preventing damp from penetrating below the roof line.

IG Service



TECHNICAL SUPPORT

IG provides comprehensive technical support for all products. Our free scheduling and specification service offers fast turnaround on standard lintels, masonry support and windpost systems.

IG leads the market with a bespoke design service for special lintels and brick slip feature lintels, including onsite measurement and technical assistance.

Our in-house experts use the latest thermal modelling software to advise clients on the optimum lintel solution for compliance with and beyond the latest building regulations.

By contacting our engineers at an early stage of your design process, you will potentially gain significantly more design flexibility for the overall project. Please send your drawings to: drawings@iglintels.com

Please refer to our Fax Back Forms for special lintel requirements. Detailed measuring advice and Fax Back Enquiry Forms are available for download at: www.iglintels.com/technical.

FASTRACK DATABASE FOR CAD

The IG Fastrack Database is accessible from the IG website and provides downloads of CAD files for a selection of IG Steel Lintels.

DELIVERY

IG's fast, efficient delivery service is renowned throughout the construction industry. Our logistics solution is recognised by our customers for superior supply chain management.

IG continues to provide the largest range of lintels available, with the shortest lead times in the industry. We have invested in large stock inventories at our three manufacturing and distribution centres reassuring our customers that all our standard lintels are instantly available upon request.

IG has revolutionised the steel lintel industry by manufacturing and delivering 'special' lintels with lead-times historically associated with ex-stock items.

IG products are available through a national network of merchant suppliers.

Standard Lintel Performance

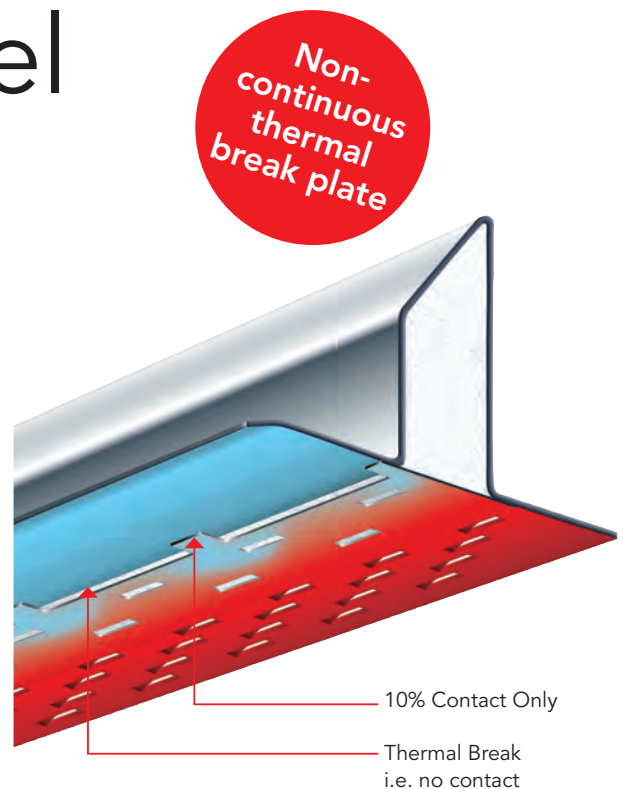
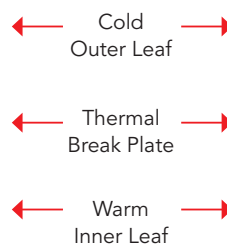

Standard IG Lintel with patented non-continuous Thermal Break Plate

FIRE PERFORMANCE

IG lintels have been subjected to a fire test (ref: WARRES No.101263) in accordance with BS 476:Part20: 1987, at Exova Warringtonfire and achieved a one hour fire performance.

GALVANISED STEEL

IG's standard range of lintels are manufactured from high quality grade pre-galvanised mild steel to BS EN 10346:2009 DX51D plus Z600 or grade Z275 to BS EN10025-2:2004 with minimised spangle finish and a minimum yield stress of 250N/mm².

STAINLESS STEEL

Please refer to page 43 for details.

STRUCTURAL PERFORMANCE

The IG Lintel range has safe working loads as detailed in each applicable loading table in our Lintel Guide brochure. The structural performance figures within each table have been ascertained by testing in accordance with the requirements of standards BS 5977 Part 2 1983 and BS EN 845-2:2003.

The figures take into account the different loading arrangements which are common to traditional cavity wall construction.

Differential Total UDL kN 3:1
Up to 75% loading on the inner leaf.

Differential Total UDL kN 19:1
Up to 95% loading on the inner leaf.

THERMAL PERFORMANCE

All IG standard lintels satisfy the thermal performance requirements of England and Wales' Part L of the building regulations, Northern Ireland's Part F and Scotland's Technical Handbook, section 6.

LINTEL LOAD TABLES

For full details of load tables specific to your lintel type please see Lintel Range & Loading Tables pages 11- 43.

Lintel types: L1/S 50, L1/S 75, L1/S 100, L1/HD 50, L1/HD 75, L1/HD 100, L1/S 50 WIL 215, L1/S 75 WIL 215, L1/S 100 WIL 215, L1/S 110, L1/S 130, L1/S 150, L10, L7, L11, L8/RB, L1/TJ, INT 100, L9, IBEAM, L1/E 50, L1/E 100, L5, L6 have been tested as a composite unit with surrounding masonry, built in accordance with BS EN 1996-2:2006.

POLYSTYRENE INSULATION

IG's lintels are insulated with expanded cfc-free polystyrene and conform to BS 13163: 2008.

LINTEL LIFE SPAN

The IG lintel range complies with the technical requirements of the BLP (Building Life Plans) regarding the durability data of mild steel, cold formed lintels.

Lintel Installation Guide

- 1 Lintels should be installed with a minimum end bearing of 150mm, bedded on mortar and levelled along its length and across its width.
- 2 The masonry above the lintel should be built in accordance with BS EN 1996-2:2006.
- 3 Raise the inner and outer leaves simultaneously to avoid excessive eccentricity of loading, with a maximum height difference of 225mm (masonry should be laid on a mortar bed and all perpendicular joints should be filled).
- 4 Allow the mortar to cure before applying floor or roof loads (Temporary propping beneath a steel lintel is practised to facilitate speed of construction).
- 5 The NHBC recommend a damp proof course (DPC) or cavity tray should be installed over all openings in external cavity walls.
- 6 When installing concrete floor units or other heavy components above a lintel, care should be taken to avoid shock loading and floor units should not be dragged into position. Masonry immediately above the lintel should be allowed to cure.
- 7 Point loads should not be applied directly onto lintel flanges. Lintels should have a minimum of 150mm masonry between the flange and the application level of any form of loading. Consult IG's technical department if applying a point load above a lintel.
- 8 The external lintel flange must project beyond the window/door frame and it is recommended that a flexible sealing compound is used between the underside of the lintel flange and the frame.
- 9 When the underside of a lintel is exposed, its appearance can be enhanced by the addition of lintel soffit cladding.
- 10 Do not cut lintels to length or modify them in any way without consulting an IG engineer.

ENSURE LINTEL IS LEVEL ALONG ITS LENGTH

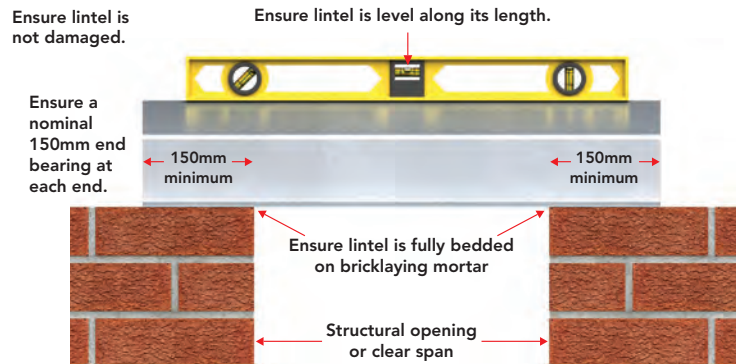

LINTEL POSITION WITHIN A CAVITY WALL

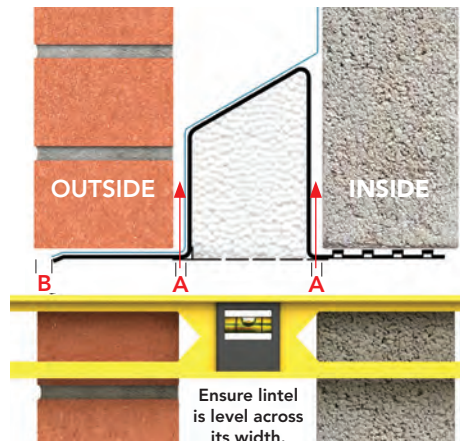

In accordance with BS EN 1996-2:2006 and NHBC requirements all external wall lintels **MUST** be installed with a flexible damp proof course with the exception of those adequately protected by an eaves overhang or similar form of protection.

- A Lintel should be centred in the cavity and the distance between lintel up-stand and masonry must not exceed 10mm
- B Masonry should not overhang any flange by more than 25mm.

PROPPING

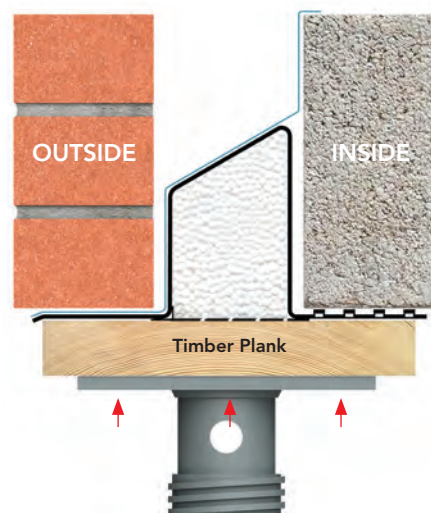

The practice of propping a lintel is sometimes used to facilitate speed of construction. It should only be introduced after initial masonry load has been applied to the lintel.

When propping a lintel, a horizontal timber plank should be placed along the underside of the lintel and suitable* props secured into place at maximum 1200mm centres.

*Suitability of props is the responsibility of site management.

Selecting the Correct Lintel

STEP 1: Select Wall Type

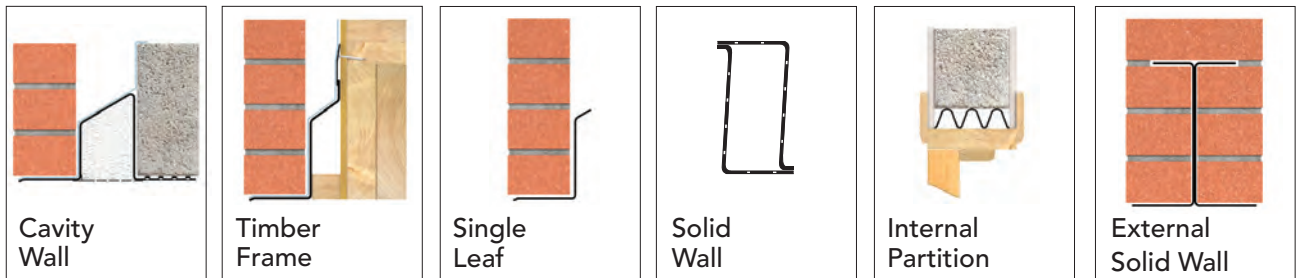

You will need to know:

- A Outer Leaf = 102mm Brick
- B Cavity = 100mm
- C Inner Leaf = 100mm Block

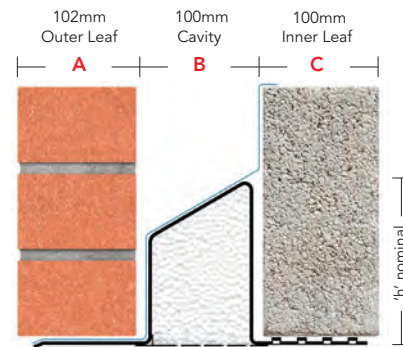

STEP 2: What is the length of the lintel?

How wide is the structural opening?

- 1 Measure the size of the structural opening i.e. the clear span between the masonry supports.
- 2 Add 150mm minimum bearing to each end.

Example lintel length =
 $150 + 1800 + 150 = 2100\text{mm}$

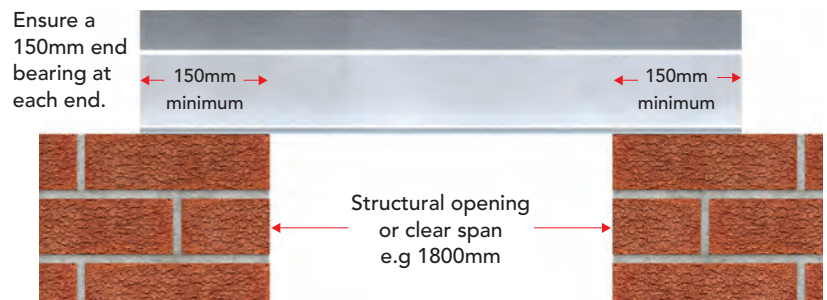

STEP 3: What is the load to be supported by the lintel?



The load on a lintel comes from...

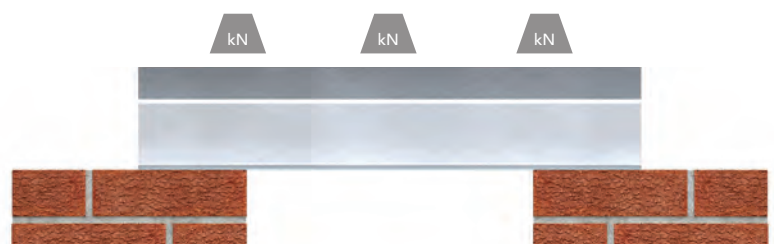





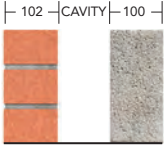
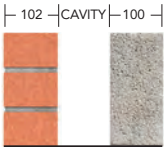
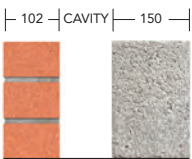
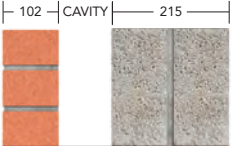
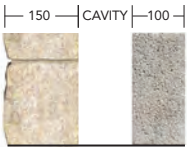

- 1 Masonry
- 2 Roof Loads: Truss/Attic/Cut/...
- 3 Floor Loads: Joists/Slabs/...
- 4 Live Loads: Residential use/Commercial use/Industrial use/...
- 5 Combination of above



NOTE: The load ratio between outer and inner leaves of the cavity wall will need to be determined. If you are not skilled in assessing loads please contact IG's Technical Team on 01633 486 486 and avail of our free scheduling service.

Lintel Range Index

WALL TYPE	LOADING	CODE	PAGE
CAVITY WALL - HI-THERM+ STEEL/RIGID POLYMER	LOADING TYPE	CODE	PAGE
<p>Psi 0.03 - 0.06 W/m·K Cavity Width 90-165mm</p> 	Standard Loading	HT/S +	11
	GALVANISED STEEL LINTEL RANGE		
CAVITY WALL - 100mm INNER LEAF	LOADING TYPE	CODE	PAGE
<p>100mm Inner Leaf Cavity Width 50-165mm</p> 	Standard Loading	L1/S	13
	Heavy Duty Loading	L1/HD	14
		L1/XHD	15
	Extra Heavy Duty Loading	L5	16
		L5/XHD	17
Extreme Duty Loading	L6	18	
CAVITY WALL - WIDE INNER LEAF	LOADING TYPE	CODE	PAGE
<p>125 - 150mm Inner Leaf Cavity Width 50-165mm</p> 	Standard Loading	L1/S WIL	20
	Heavy Duty Loading	L1/HD WIL	21
		L1/XHD WIL	22
	Extra Heavy Duty Loading	L5 WIL	23
		L5/XHD WIL	24
Extreme Duty Loading	L6 WIL	25	
<p>215mm Inner Leaf Cavity Width 50-165mm</p> 	Standard Loading	L1/S WIL 215	26
	Heavy Duty Loading	L1/HD WIL 215	27
	Extreme Duty Loading	L6 WIL 215	28
CAVITY WALL - WIDE OUTER LEAF	LOADING TYPE	CODE	PAGE
<p>125 - 150mm Outer Leaf Cavity Width 50-165mm</p> 	Standard Loading	L1/S WOL	30
	Heavy Duty Loading	L1/HD WOL	31
		L1/XHD WOL	32
	Extra Heavy Duty Loading	L5 WOL	33
		L5/XHD WOL	34
Extreme Duty Loading	L6 WOL	35	
<p>215mm Outer Leaf Cavity Width 50-165mm</p> 	Standard Loading	L1/S WOL 215	36
	EAVES LINTEL		
	LOADING TYPE	CODE	PAGE
	Standard Loading	L1/E 100	37

WALL TYPE		LOADING	CODE	PAGE
CAVITY WALL - POROTHERM		LOADING TYPE	CODE	PAGE
		Standard Loading	See 2 part spec.	38
		Standard/Heavy Duty Loading	See 2 part spec.	39
		Heavy Duty Loading	See 2 part spec.	39
TIMBER FRAME WALL		LOADING TYPE	CODE	PAGE
Various Cavity Widths 		Standard Loading	L7	41
		Heavy Duty Loading	L7/HD	42
		Extra Heavy Duty Loading	L7/XHD	40
		SOLID WALL - SINGLE LEAF		LOADING TYPE
		Standard Loading	L10	43
		Heavy Duty Loading	L11	43
SOLID WALL - BOX LINTELS		LOADING TYPE	CODE	PAGE
		Standard Loading	BOX 75	44
			BOX 100	45
			BOX 140	45
			BOX 200	45
		Heavy Duty Loading	HD BOX 100	46
			HD BOX 140	46
			HD BOX 200	47
SOLID WALL - 100mm WALL WIDTH		LOADING TYPE	CODE	PAGE
		Standard Loading	INT 100	48
			L9 SW 100	48
SOLID WALL - 215mm WALL WIDTH		LOADING TYPE	CODE	PAGE
		Standard Loading	L9	48
			I BEAM 2C	49
			I BEAM 3C	49
		Extra Heavy Duty Loading	XHD I BEAM	49
EXTENDED LINTEL RANGE		PRODUCT TYPE	CODE	PAGE
Various Cavity Widths 		Roller Shutter	-	50
		Cant Brick/Stepped Lintel	-	51
		Feature Plate	-	51
		Universal Arch Lintel	IGAR	51
		Weep Vents & Stop Ends	-	52
		SAINLESS STEEL RANGE LINTEL RANGE		
Various Cavity Widths 		IG Standard Lintels are also available in stainless steel. Outstanding durability through austenitic chromium nickel steel BS EN 10088-part 2 Astm 240 (European Grade 1.4307). Suitable for use in coastal and industrial environments. All IG galvanised steel loading tables apply.		53

Hi-therm+ Lintel

The low cost solution to reduced carbon emissions and improved Fabric Energy Efficiency

100mm
INNER LEAF



IG leads the way with the development of a completely unique lintel range to address the thermal requirements of new building regulations which require that lintels should be assessed for their effect on the thermal performance of a building. The thermal performance of a lintel is expressed in terms of Psi Values (Ψ) i.e. linear thermal transmittance.

KEY BENEFITS

- Up to 5 times more thermally efficient than a standard steel cavity wall lintel.
- Hi-therm+ is the only BBA approved thermally enhanced lintel on the market.
- Hi-therm+ achieves the Appendix R value for steel lintels in Part L.
- Hi-therm+ is a low cost solution to improving both the CO₂ & Fabric targets in line with Part L Building Regulations.
- Hi-therm+ will assist with achieving Part L with 100mm cavity therefore reducing the need for wider cavities.
- Hi-therm+ will assist with part L compliance without the need for renewable technologies.
- Better Buildability - offers the simplicity of a one piece, structurally superior top hat design creating stability during the building process, unlike a two part lintel solution.
- Maintenance free.

Psi COMPARISON CHART

Hi-therm+ can achieve the Appendix R value for steel lintels in Part L 2013 depending on the wall construction. This table shows how Hi-therm+ outperforms all other lintel types.

LINTEL TYPE COMPARISON	VALUES
IG Hi-therm+ Lintel	0.03-0.06 W/m.K
Part L Appendix R value	0.05 W/m.K
Standard Lintel	0.22 W/m.K
Default Non Plated Steel Lintel	0.33 W/m. K
Plated Steel Lintel (Default) Table K1	0.5 W/m. K

* Depending on wall construction

Psi 0.03 - 0.06 W/m.k

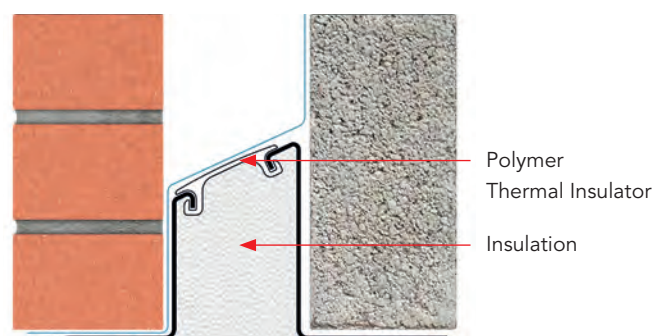

Hi-therm+ Lintel

Available for cavity widths from 90mm to 165mm

OUTER LEAF	INNER LEAF
102mm	100mm



HT/S+ STANDARD LOAD

Blockwork built tight against inner face of the lintel. Place mortar bed on top of blockwork before floor units are laid to provide even distribution of load. Lintels may be propped to facilitate speed of construction. See Lintel Installation on page 6.

HT/S+ 100 For cavity widths 90-105mm

Manufactured Length 150 increments	600-1200	1350-1500	1650-1800	1950-2100	2250-2400	2550-2700	2850-3000	3150-3600	3750-4200
Height (h)	100	107	150	150	175	190	190	234	234
Thickness	1.6	2.0	2.0	2.0/2.5	2.0/2.5	2.5	2.5/2.9	2.9	3.2
Total UDL kN 3:1	12	16	19	21	23	27	27	27	27
Total UDL kN 19:1	10	13	16	17	18	22	20	20	22

Standard Load

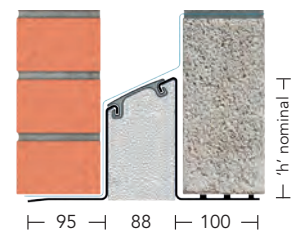

HT/S+ 110 For cavity widths 110-125mm

Manufactured Length 150 increments	600-1500	1650-1800	1950-2100	2250-3000	3150-3600	3750-4200
Height (h)	118	118	130	190	234	234
Thickness	2.0	2.0/2.5	2.5	2.5/2.9	2.9	3.2
Total UDL kN 3:1	16	22	21	27	27	27
Total UDL kN 19:1	13	18	17	22	20	22

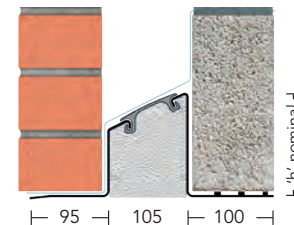

HT/S+ 130 For cavity widths 130-145mm

Manufactured Length 150 increments	600-1500	1650-1800	1950-2100	2250-3000	3150-3600	3750-4200
Height (h)	118	118	130	190	234	234
Thickness	2.0	2.0/2.5	2.5	2.5/2.9	2.9	3.2
Total UDL kN 3:1	16	22	21	27	27	27
Total UDL kN 19:1	13	18	17	22	20	22

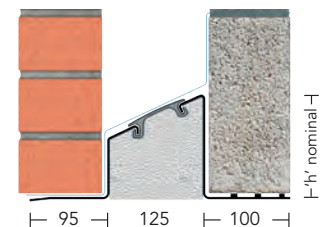

HT/S+ 150 For cavity widths 150-165mm

Manufactured Length 150 increments	600-1500	1650-1800	1950-2100	2250-3000	3150-3600	3750-4200
Height (h)	118	118	130	190	234	234
Thickness	2.0	2.0/2.5	2.5	2.5/2.9	2.9	3.2
Total UDL kN 3:1	16	22	21	27	27	27
Total UDL kN 19:1	13	18	17	22	20	22

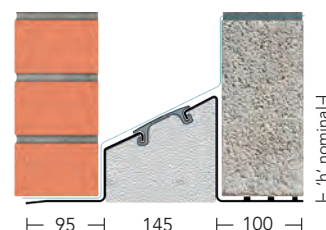

Please note other cavity widths and loading conditions are available.

100mm Inner Leaf Lintel

**100mm
INNER LEAF**



Please use this table to identify the Lintel code required based on cavity width and loading. Contact our technical department for more details on these lintel options. Please note that only a selection of the range is illustrated in this manual.

100mm Inner Leaf

		LOADING					
CAVITY WIDTH	Cavity Width (mm)	Standard	Heavy Duty	Heavy Duty	Extra Heavy Duty	Extra Heavy Duty	Extreme
	* 50 - 65	L1/S 50	L1/HD 50	L1/XHD 50	L5/ 50	L5/XHD 50	L6/ 50
	* 70 - 85	L1/S 75	L1/HD 75	L1/XHD 75	L5/ 75	L5/XHD 75	L6/ 75
	90 - 105	L1/S 100	L1/HD 100	L1/XHD 100	L5/ 100	L5/XHD 100	L6/ 100
	110 - 125	L1/S 110	L1/HD 110	L1/XHD 110	L5/ 110	L5/XHD 110	L6/ 110
	* 130 - 145	L1/S 130	L1/HD 130	L1/XHD 130	L5/ 130	L5/XHD 130	L6/ 130
	150 - 165	L1/S 150	L1/HD 150	L1/XHD 150	L5/ 150	L5/XHD 150	L6/ 150

*Cavity widths with asterisk are not illustrated in this manual - contact our technical department for details.

Cavity Wall

Available for cavity widths from 50mm to 165mm

OUTER LEAF

INNER LEAF

102mm

100mm



L1/S

Place mortar bed on top of blockwork before floor units are laid to provide even distribution of load. Lintels may be propped to facilitate speed of construction. See Lintel Installation on page 6.

DAMP PROOFING

Provide a damp proof course over all lintels. For more guidance please see our on-line brochures or contact our technical team.

Standard Load

L1/S 100	For cavity widths 90-105mm									
Manufactured length 150mm increments	600-1200	1350-1500	1650-1800	1950-2100	2250-2400	2550-2700	2850-3000	3150-3600	3750-4050	4200-4800
Height 'h'	88	85	107	125	150	162	171	200	200	200
Thickness	1.6	2.0	2.0	2.0	2.0	2.6	2.6	3.2	3.2	3.4
Total UDL kN 3:1	12	16	19	21	23	27	27	27	26	27
Total UDL kN 19:1	10	13	16	17	18	22	20	20	19	22

90-105mm cavity

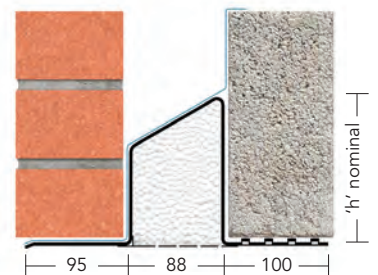

L1/S 110	For cavity widths 110-125mm						
Manufactured length 150mm increments	600-1500	1650-1800	1950-2100	2250-2700	2850-3000	3150-4050	4200-4800
Height 'h'	97	113	125	163	193	193	218
Thickness	2.0	2.0	2.0	2.5	2.9	3.2	3.2
Total UDL kN 3:1	16	22	21	25	27	26	25
Total UDL kN 19:1	13	18	17	20	22	19	20

110-125mm cavity

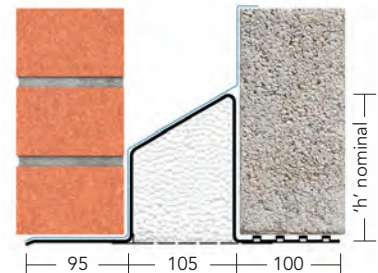

L1/S 150	For cavity widths 150-165mm						
Manufactured length 150mm increments	600-1500	1650-1800	1950-2100	2250-2700	2850-3000	3150-4050	4200-4800
Height 'h'	100	118	130	148	173	173	199
Thickness	2.0	2.0	2.0	2.5	2.9	3.2	3.2
Total UDL kN 3:1	16	22	21	25	27	26	25
Total UDL kN 19:1	13	18	17	20	22	19	20

150-165mm cavity

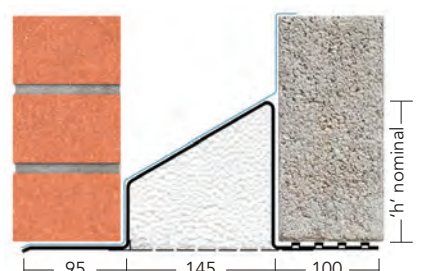

Please note other cavity widths and loading conditions are available.

Cavity Wall

Available for cavity widths from **50mm to 165mm**

OUTER LEAF

INNER LEAF

102mm

100mm



L1/HD

Blockwork built tight against inner face of the lintel. Place mortar bed on top of blockwork before floor units are laid to provide even distribution of load. Lintels may be propped to facilitate speed of construction. See Lintel Installation on page 6.

DAMP PROOFING

Provide a damp proof course over all lintels. For more guidance please see our on-line brochures or contact our technical team.

Heavy Duty Load

L1/HD 100		For cavity widths 90-105mm					
Manufactured length 150mm increments	600-1200	1350-1500	1650-2100	2250-2550	2700-3000	3150-3600	3750-4200
Height 'h'	110	135	163	203	203	203	203
Thickness	2.9	2.9	2.9	2.9	3.2	3.2	3.2
Total UDL kN 3:1	30	30	40	40	40	35	33
Total UDL kN 19:1	22	22	35	35	35	32	28

90-105mm cavity

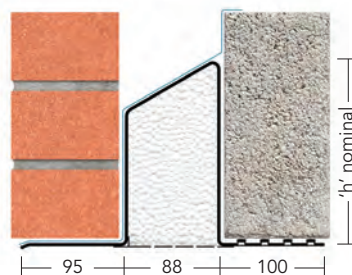

L1/HD 110		For cavity widths 110-125mm			
Manufactured length 150mm increments	600-1500	1650-2100	2250-3000	3150-3600	3750-4050
Height 'h'	125	145	195	195	195
Thickness	2.9	2.9	3.2	3.2	3.2
Total UDL kN 3:1	30	30	35	32	30
Total UDL kN 19:1	20	22	30	28	26

110-125mm cavity

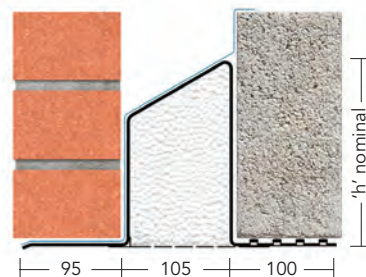

L1/HD 150		For cavity widths 150-165mm			
Manufactured length 150mm increments	600-1500	1650-2100	2250-3000	3150-3600	3750-4050
Height 'h'	125	160	180	180	200
Thickness	2.9	2.9	3.2	3.2	3.2
Total UDL kN 3:1	30	30	35	30	30
Total UDL kN 19:1	20	22	30	25	26

150-165mm cavity

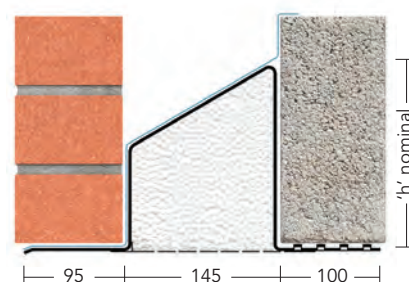

Please note other cavity widths and loading conditions are available.

Cavity Wall

Available for cavity widths from **50mm to 165mm**

OUTER LEAF	INNER LEAF
102mm	100mm



L1/XHD

Blockwork built tight against inner face of the lintel. Place mortar bed on top of blockwork before floor units are laid to provide even distribution of load. Lintels may be propped to facilitate speed of construction. See Lintel Installation on page 6.

DAMP PROOFING

Provide a damp proof course over all lintels. For more guidance please see our on-line brochures or contact our technical team.

Heavy Duty Load

L1/XHD 100	For cavity widths 90-105mm			
Manufactured length 150mm increments	600-1500	1650-1800	1950-2100	2250-2700
Height 'h'	163	163	203	203
Thickness	3.2	3.2	3.2	3.2
Total UDL kN 3:1	50	50	55	50
Total UDL kN 19:1	45	45	45	40

90-105mm cavity

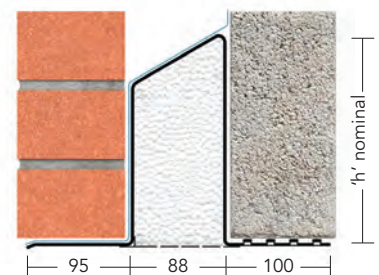

L1/XHD 110	For cavity widths 110-125mm		
Manufactured length 150mm increments	600-1500	1650-1800	1950-2100
Height 'h'	145	145	195
Thickness	3.2	3.2	3.2
Total UDL kN 3:1	45	45	50
Total UDL kN 19:1	40	40	40

110-125mm cavity

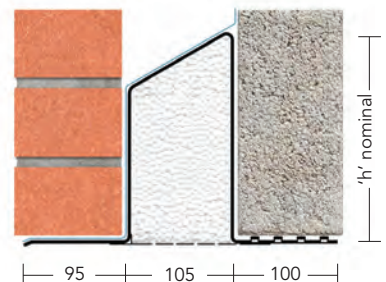

L1/XHD 150	For cavity widths 150-165mm		
Manufactured length 150mm increments	600-1500	1650-1800	1950-2100
Height 'h'	160	160	200
Thickness	3.2	3.2	3.2
Total UDL kN 3:1	45	45	50
Total UDL kN 19:1	40	40	40

150-165mm cavity

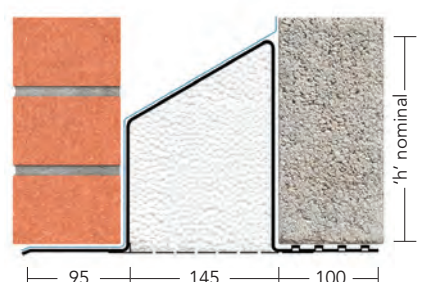

Please note other cavity widths and loading conditions are available.

Cavity Wall

Available for cavity widths from **50mm to 165mm**

OUTER LEAF

102mm

INNER LEAF

100mm



L5

To achieve loading figures lintel must be built in with blockwork as shown. Ensure all perpendicular and horizontal joints are filled with mortar. Place mortar bed on top of blockwork before floor units are laid to provide even distribution of load. Lintels may be propped to facilitate speed of construction. See Lintel Installation on page 6.

DAMP PROOFING

Provide a damp proof course over all lintels. For more guidance please see our on-line brochures or contact our technical team.

Extra Heavy Duty Load

L5/100		For cavity widths 90-105mm		
Manufactured length 150mm increments		600- 2400	2550- 3600	3750- 4800
Height 'h'		229	229	229
Thickness		2.5	3.0	3.0
Total UDL kN 19:1		48	50	38

90-105mm cavity

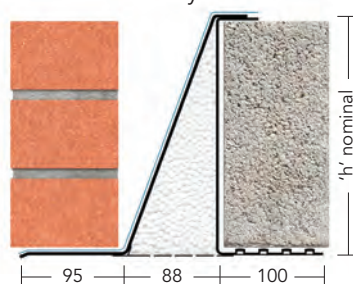

L5/110		For cavity widths 110-125mm		
Manufactured length 150mm increments		600- 2400	2550- 3600	3750- 4800
Height 'h'		229	229	229
Thickness		2.5	3.0	3.0
Total UDL kN 19:1		48	50	38

110-125mm cavity

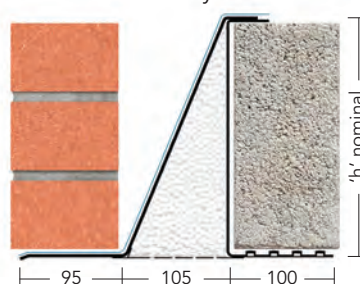

L5/150		For cavity widths 150-165mm		
Manufactured length 150mm increments		600- 2400	2550- 3600	3750- 4800
Height 'h'		229	229	229
Thickness		2.5	3.0	3.0
Total UDL kN 19:1		48	50	38

150-165mm cavity

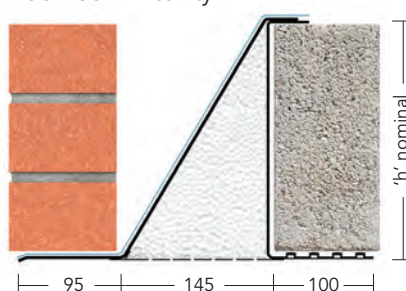

Please note other cavity widths and loading conditions are available.

Cavity Wall

Available for cavity widths from 50mm to 165mm

OUTER LEAF	INNER LEAF
102mm	100mm



L5/XHD

To achieve loading figures lintel must be built in with blockwork as shown. Ensure all perpendicular and horizontal joints are filled with mortar. Place mortar bed on top of blockwork before floor units are laid to provide even distribution of load. Lintels may be propped to facilitate speed of construction. See Lintel Installation on page 6.

DAMP PROOFING

Provide a damp proof course over all lintels. For more guidance please see our on-line brochures or contact our technical team.

Extra Heavy Duty Load

L5/XHD 100 For cavity widths 90-105mm					
Manufactured length 150mm increments	600-1800	1950-2400	2550-3000	3150-3600	3750-4800-
Height 'h'	235	235	235	235	235
Thickness Inner	5.0	5.0	5.0	5.0	5.0
Thickness Outer	2.9	2.9	2.9	3.2	3.2
Total UDL kN 19:1	100	90	80	65	50

90-105mm cavity

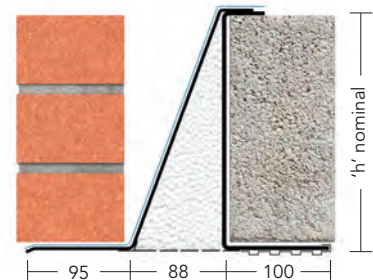

L5/XHD 110 For cavity widths 110-125mm					
Manufactured length 150mm increments	600-1800	1950-2400	2550-3000	3150-3600	3750-4800-
Height 'h'	235	235	235	235	235
Thickness Inner	5.0	5.0	5.0	5.0	5.0
Thickness Outer	2.9	2.9	2.9	3.2	3.2
Total UDL kN 19:1	100	90	80	65	50

110-125mm cavity

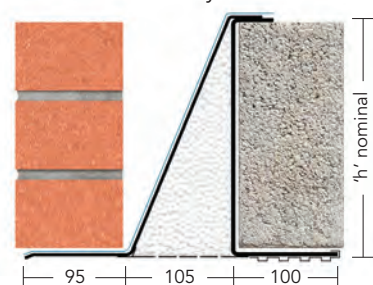

L5/XHD 150 For cavity widths 150-165mm					
Manufactured length 150mm increments	600-1800	1950-2400	2550-3000	3150-3600	3750-4800-
Height 'h'	235	235	235	235	235
Thickness Inner	5.0	5.0	5.0	5.0	5.0
Thickness Outer	2.9	2.9	2.9	3.2	3.2
Total UDL kN 19:1	100	90	80	65	50

150-165mm cavity

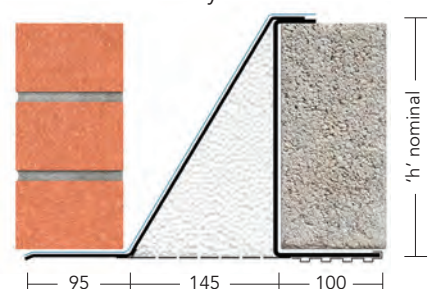

Please note other cavity widths and loading conditions are available.

Cavity Wall

Available for cavity widths from 50mm to 165mm

OUTER LEAF	INNER LEAF
102mm	100mm



L6

To achieve loading figures lintel must be laterally restrained. Lintels may be propped to facilitate speed of construction. See Lintel Installation on page 6. Galvanised steel flange to outer leaf.

DAMP PROOFING

Provide a damp proof course over all lintels. For more guidance please see our on-line brochures or contact our technical team.

Extreme Load

L6/100	For cavity widths 90-105mm					
Manufactured length (mm) to customer requirements	600-4800	5200	5400	5800	6200	6600
End Bearing	200	200	200	200	200	200
Total UDL kN 19:1	80	70	62	55	45	40

90-105mm cavity



L6/110	For cavity widths 110-125mm					
Manufactured length (mm) to customer requirements	600-4800	5200	5400	5800	6200	6600
End Bearing	200	200	200	200	200	200
Total UDL kN 19:1	80	70	62	55	45	40

110-125mm cavity

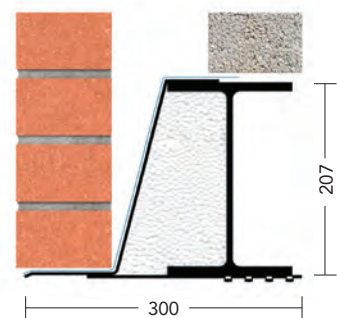

L6/150	For cavity widths 150-165mm					
Manufactured length (mm) to customer requirements	600-4800	5200	5400	5800	6200	6600
End Bearing	200	200	200	200	200	200
Total UDL kN 19:1	80	70	62	55	45	40

150-165mm cavity

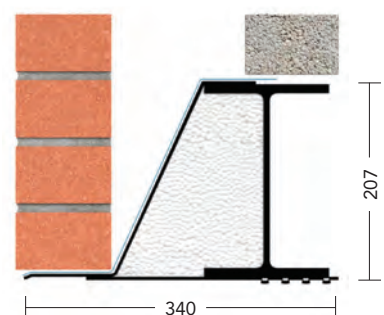

Please note other cavity widths and loading conditions are available.



Cavity Wall

Available for cavity widths from 50mm to 165mm

LINTEL HOTLINE
01633 486486

Wide Inner Leaf Lintel

125 - 150mm
INNER LEAF

215mm
INNER LEAF



Please use this table to identify the Lintel code required based on cavity width and loading. Contact our technical department for more details on these lintel options. Please note that only a selection of the range is illustrated in this manual.

125mm - 150mm Inner Leaf

		LOADING					
CAVITY WIDTH	Cavity Width (mm)	Standard	Heavy Duty	Heavy Duty	Extra Heavy Duty	Extra Heavy Duty	Extreme
	* 50 - 65*	L1/S 50 WIL	L1/HD 50 WIL	L1/XHD 50 WIL	L5/ 50 WIL	L5/XHD 50 WIL	L6/ 50 WIL
	* 70 - 85*	L1/S 75 WIL	L1/HD 75 WIL	L1/XHD 75 WIL	L5/ 75 WIL	L5/XHD 75 WIL	L6/ 75 WIL
	90 - 105	L1/S 100 WIL	L1/HD 100 WIL	L1/XHD 100 WIL	L5/ 100 WIL	L5/XHD 100 WIL	L6/ 100 WIL
	110 - 125	L1/S 110 WIL	L1/HD 110 WIL	L1/XHD 110 WIL	L5/ 110 WIL	L5/XHD 110 WIL	L6/ 110 WIL
	* 130 - 145*	L1/S 130 WIL	L1/HD 130 WIL	L1/XHD 130 WIL	L5/ 130 WIL	L5/XHD 130 WIL	L6/ 130 WIL
	150 - 165	L1/S 150 WIL	L1/HD 150 WIL	L1/XHD 150 WIL	L5/ 150 WIL	L5/XHD 150 WIL	L6/ 150 WIL

*Cavity widths with asterisk are not illustrated in this manual - contact our technical department for details.

215mm Inner Leaf

		LOADING		
CAVITY WIDTH	Cavity Width (mm)	Standard Loading	Heavy Duty Loading	Extreme Loading
	* 50 - 65*	L1/S 50 WIL 215	L1/HD 50 WIL 215	L6/ 50 WIL 215
	* 70 - 85*	L1/S 75 WIL 215	L1/HD 75 WIL 215	L6/ 75 WIL 215
	90 - 105	L1/S 100 WIL 215	L1/HD 100 WIL 215	L6/ 100 WIL 215
	110 - 125	L1/S 110 WIL 215	L1/HD 110 WIL 215	L6/ 110 WIL 215
	* 130 - 145*	L1/S 130 WIL 215	L1/HD 130 WIL 215	L6/ 130 WIL 215
	150 - 165	L1/S 150 WIL 215	L1/HD 150 WIL 215	L6/ 150 WIL 215

*Cavity widths with asterisk are not illustrated in this manual - contact our technical department for details.

Cavity Wall - Wide Inner Leaf

Available for cavity widths from 50mm to 165mm

OUTER LEAF	INNER LEAF
102mm	125mm - 150mm



L1/S WIL

Lintels may be propped to facilitate speed of construction. See Lintel Installation on page 6. Inner leaf block should not overhang the lintel flange by more than 25mm.

DAMP PROOFING

Provide a damp proof course over all lintels. For more guidance please see our on-line brochures or contact our technical team.

Standard Load

For 150mm wide inner leaf blockwork.

L1/S 100 WIL	For cavity widths 90-105mm						
Manufactured length 150mm increments	600-1200	1350-1800	1950-2400	2550-3000	3150-3600	3750-4050	4200
Height 'h'	82	107	142	177	191	187	187
Thickness	1.6	2.0	2.0	2.6	3.2	3.2	3.4
Total UDL kN 3:1	13	17	23	24	30	27	26
Total UDL kN 19:1	11	14	18	18	26	25	21

90-105mm cavity

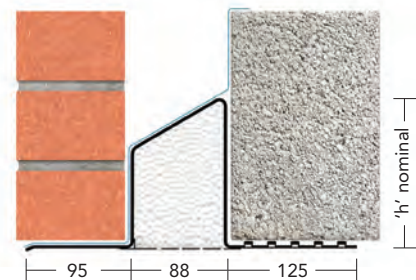

L1/S 110 WIL	For cavity widths 110-125mm				
Manufactured length 150mm increments	600-1200	1350-1800	1950-2100	2250-3000	3150-4050
Height 'h'	95	107	142	185	185
Thickness	2.0	2.0	2.5	2.9	3.2
Total UDL kN 3:1	13	17	23	24	24
Total UDL kN 19:1	11	14	18	18	17

110-125mm cavity

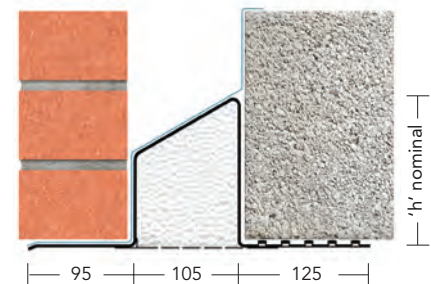

L1/S 150 WIL	For cavity widths 150-165mm				
Manufactured length 150mm increments	600-1200	1350-1800	1950-2100	2250-3000	3150-4050
Height 'h'	88	115	168	168	168
Thickness	2.0	2.0	2.5	2.9	3.2
Total UDL kN 3:1	13	17	23	24	24
Total UDL kN 19:1	11	14	18	18	17

150-165mm cavity

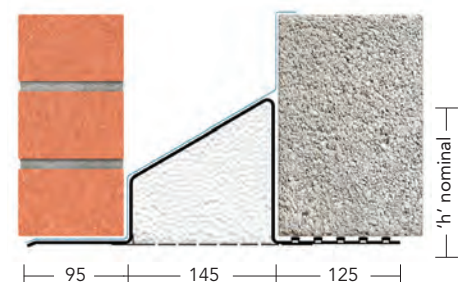

Please note other cavity widths and loading conditions are available.

Cavity Wall - Wide Inner Leaf

Available for cavity widths from 50mm to 165mm

OUTER LEAF	INNER LEAF
102mm	125mm - 150mm



L1/HD WIL

Lintels may be propped to facilitate speed of construction. See Lintel Installation on page 6. Inner leaf block should not overhang the lintel flange by more than 25mm. Blockwork built tight against inner face of the lintel. Place mortar bed on top of blockwork before floor units are laid to provide even distribution of load.

DAMP PROOFING

Provide a damp proof course over all lintels. For more guidance please see our on-line brochures or contact our technical team.

Heavy Duty Load For 150mm wide inner leaf blockwork.

L1/HD 100 WIL For cavity widths 90-105mm				
Manufactured length 150mm increments	600-1350	1500-1800	1950-2100	2250-2700
Height 'h'	113	144	188	188
Thickness	2.9	2.9	2.9	3.2
Total UDL kN 3:1	20	35	30	36
Total UDL kN 19:1	17	27	25	32

90-105mm cavity

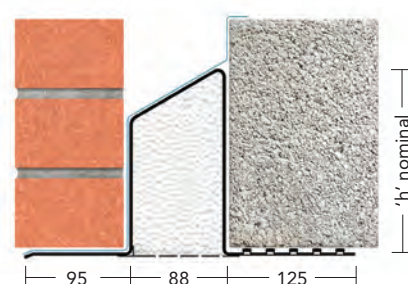

L1/HD 110 WIL For cavity widths 110-125mm				
Manufactured length 150mm increments	600-1350	1500-1800	1950-2100	2250-2700
Height 'h'	131	148	195	195
Thickness	2.9	2.9	2.9	3.2
Total UDL kN 3:1	20	30	30	36
Total UDL kN 19:1	17	25	25	32

110-125mm cavity

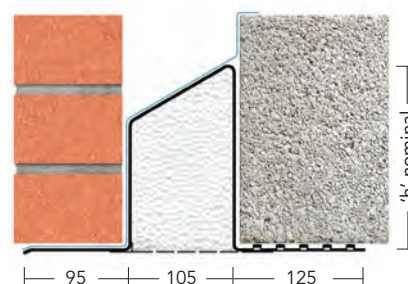

L1/HD 150 WIL For cavity widths 150-165mm				
Manufactured length 150mm increments	600-1350	1500-1800	1950-2100	2250-2700
Height 'h'	115	168	180	200
Thickness	2.9	2.9	2.9	3.2
Total UDL kN 3:1	20	30	30	36
Total UDL kN 19:1	17	25	25	32

150-165mm cavity

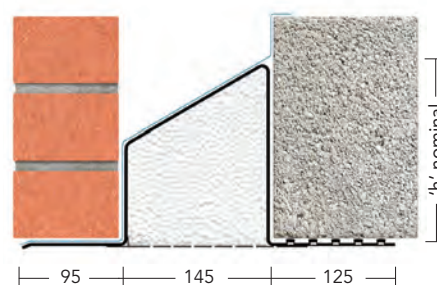

Please note other cavity widths and loading conditions are available.

Cavity Wall - Wide Inner Leaf

Available for cavity widths from 50mm to 165mm

OUTER LEAF

102mm

INNER LEAF

125mm -
150mm



L1/XHD WIL

Lintels may be propped to facilitate speed of construction. See Lintel Installation on page 6. Inner leaf block should not overhang the lintel flange by more than 25mm. Blockwork built tight against inner face of the lintel. Place mortar bed on top of blockwork before floor units are laid to provide even distribution of load.

DAMP PROOFING

Provide a damp proof course over all lintels. For more guidance please see our on-line brochures or contact our technical team.

Heavy Duty Load

For 150mm wide inner leaf blockwork.

L1/XHD 100 WIL For cavity widths 90-105mm

Manufactured length 150mm increments	600- 1500	1650- 1800	1950- 2100
Height 'h'	165	188	188
Thickness	3.2	3.2	3.2
Total UDL kN 3:1	45	50	45
Total UDL kN 19:1	40	40	40

90-105mm cavity

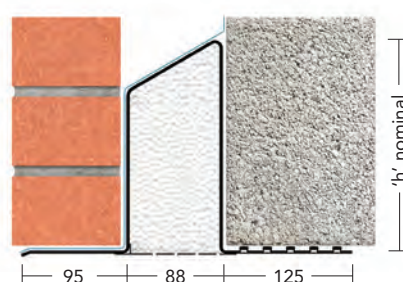

L1/XHD 110 WIL For cavity widths 110-125mm

Manufactured length 150mm increments	600- 1500	1650- 1800	1950- 2100
Height 'h'	185	195	195
Thickness	3.2	3.2	3.2
Total UDL kN 3:1	45	50	45
Total UDL kN 19:1	40	40	40

110-125mm cavity

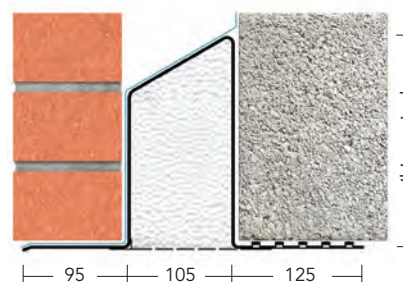

L1/XHD 150 WIL For cavity widths 150-165mm

Manufactured length 150mm increments	600- 1500	1650- 1800	1950- 2100
Height 'h'	180	200	200
Thickness	3.2	3.2	3.2
Total UDL kN 3:1	45	50	45
Total UDL kN 19:1	40	40	40

150-165mm cavity

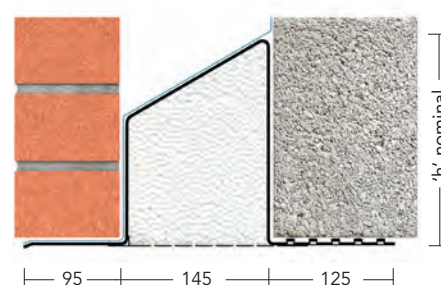

Please note other cavity widths and loading conditions are available.

Cavity Wall - Wide Inner Leaf

Available for cavity widths from 50mm to 165mm

OUTER LEAF	INNER LEAF
102mm	125mm - 150mm



L5/ WIL

Lintels may be propped to facilitate speed of construction. See Lintel Installation on page 6. Inner leaf block should not overhang the lintel flange by more than 25mm. Blockwork built tight against inner face of the lintel. Place mortar bed on top of blockwork before floor units are laid to provide even distribution of load.

DAMP PROOFING

Provide a damp proof course over all lintels. For more guidance please see our on-line brochures or contact our technical team.

Extra Heavy Duty Load

For 150mm wide inner leaf blockwork.

L5/100 WIL	For cavity widths 90-105mm				
Manufactured length 150mm increments	600-1500	1650-2100	2250-3000	3150-4050	4200-4800
Height 'h'	229	229	229	229	229
Thickness	2.9	2.9	2.9	3.2	3.2
Total UDL kN 19:1	70	60	50	45	40

90-105mm cavity

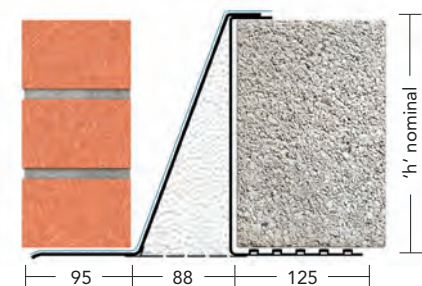

L5/110 WIL	For cavity widths 110-125mm				
Manufactured length 150mm increments	600-1500	1650-2100	2250-3000	3150-4050	4200-4800
Height 'h'	229	229	229	229	229
Thickness	2.9	2.9	2.9	3.2	3.2
Total UDL kN 19:1	70	60	50	45	40

110-125mm cavity

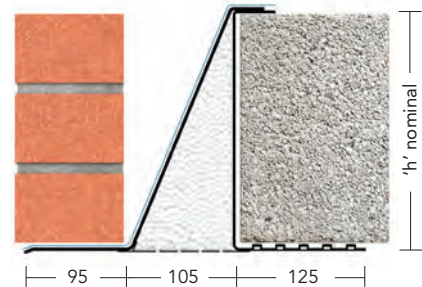

L5/150 WIL	For cavity widths 150-165mm				
Manufactured length 150mm increments	600-1500	1650-2100	2250-3000	3150-4050	4200-4800
Height 'h'	229	229	229	229	229
Thickness	2.9	2.9	2.9	3.2	3.2
Total UDL kN 19:1	70	60	50	45	40

150-165mm cavity

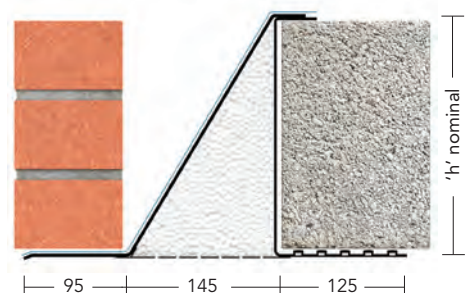

Please note other cavity widths and loading conditions are available.

Cavity Wall - Wide Inner Leaf

Available for cavity widths from 50mm to 165mm

OUTER LEAF

INNER LEAF

102mm

140mm -
150mm



L5/XHD WIL

Lintels may be propped to facilitate speed of construction. See Lintel Installation on page 6. Inner leaf block should not overhang the lintel flange by more than 25mm. Blockwork built tight against inner face of the lintel. Place mortar bed on top of blockwork before floor units are laid to provide even distribution of load.

DAMP PROOFING

Provide a damp proof course over all lintels. For more guidance please see our on-line brochures or contact our technical team.

Extra Heavy Duty Load

For 150mm wide inner leaf blockwork.

L5/XHD 100 WIL For cavity widths 90-105mm

Manufactured length 150mm increments	600- 1800	1950- 2400	2550- 3000	3150- 3600
Height 'h'	235	235	235	235
Thickness Inner	5.0	5.0	5.0	5.0
Thickness Outer	2.9	2.9	2.9	3.2
Total UDL kN 19:1	100	90	80	65

90-105mm cavity

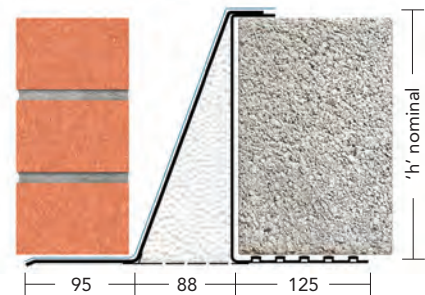

L5/XHD 110 WIL For cavity widths 110-125mm

Manufactured length 150mm increments	600- 1800	1950- 2400	2550- 3000	3150- 3600
Height 'h'	235	235	235	235
Thickness Inner	5.0	5.0	5.0	5.0
Thickness Outer	2.9	2.9	2.9	3.2
Total UDL kN 19:1	100	90	80	65

110-125mm cavity

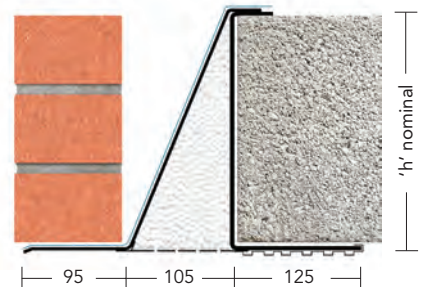

L5/XHD 150 WIL For cavity widths 150-165mm

Manufactured length 150mm increments	600- 1800	1950- 2400	2550- 3000	3150- 3600
Height 'h'	235	235	235	235
Thickness Inner	5.0	5.0	5.0	5.0
Thickness Outer	2.9	2.9 <td 2.9	3.2	
Total UDL kN 19:1	100	90	80	65

150-165mm cavity

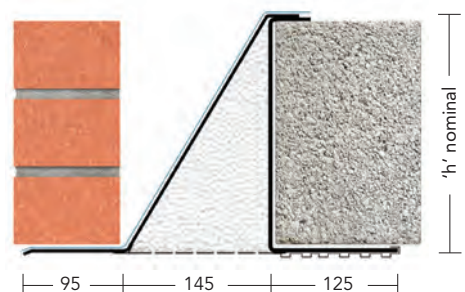

Please note other cavity widths and loading conditions are available.

Cavity Wall - Wide Inner Leaf

Available for cavity widths from 50mm to 165mm

OUTER LEAF	INNER LEAF
102mm	125mm - 150mm



L6/ WIL

To achieve loading figures lintel must be laterally restrained. Lintels may be propped to facilitate speed of construction. See Lintel Installation on page 6.

DAMP PROOFING

Provide a damp proof course over all lintels. For more guidance please see our on-line brochures or contact our technical team.

Extreme Load

For 150mm wide inner leaf blockwork.

L6/100 WIL	For cavity widths 90-105mm					
Manufactured length (mm) to customer requirements	600-4800	5200	5400	5800	6200	6600
End Bearing	200	200	200	200	200	200
Total UDL kN 19:1	80	70	62	55	45	40

For 150mm wide inner leaf blockwork.

90-105mm cavity

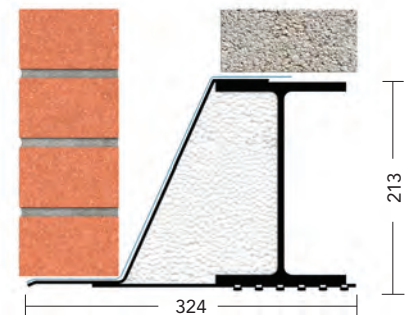

L6/110 WIL	For cavity widths 110-125mm					
Manufactured length (mm) to customer requirements	600-4800	5200	5400	5800	6200	6600
End Bearing	200	200	200	200	200	200
Total UDL kN 19:1	80	70	62	55	45	40

110-125mm cavity

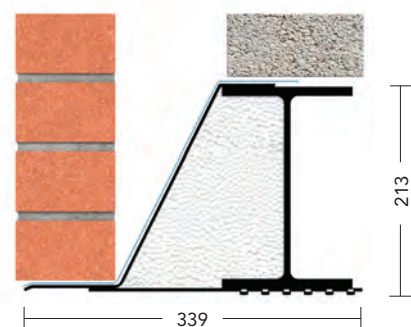

L6/150 WIL	For cavity widths 150-165mm					
Manufactured length (mm) to customer requirements	600-4800	5200	5400	5800	6200	6600
End Bearing	200	200	200	200	200	200
Total UDL kN 19:1	80	70	62	55	45	40

150-165mm cavity

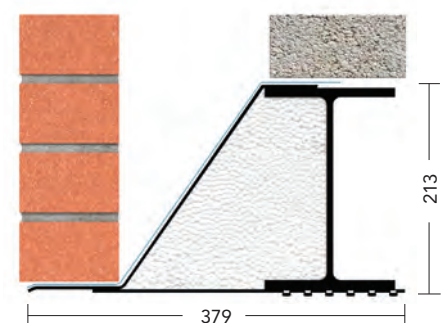

Please note other cavity widths and loading conditions are available.

Cavity Wall - Wide Inner Leaf 215

Available for cavity widths from 50mm to 165mm

OUTER LEAF	INNER LEAF
102mm	215mm



L1/S WIL 215

Lintels may be propped to facilitate speed of construction. See Lintel Installation on page 6. Inner leaf block should not overhang the lintel flange by more than 25mm.

DAMP PROOFING

Provide a damp proof course over all lintels. For more guidance please see our on-line brochures or contact our technical team.

Standard Load For 215mm wide inner leaf blockwork.

L1/S 100 WIL 215	Cavity widths 90-105mm						
Manufactured length 150mm increments	600- 1350	1500- 1650	1800- 2100	2250- 2400	2550- 2700	2850- 3000	3150- 4050
Height 'h'	105	105	138	163	163	200	200
Thickness	2.5	2.5	2.5	2.5	2.9	2.9	2.9
Total UDL kN 3:1	25	25	30	35	40	40	40
Total UDL kN 19:1	20	20	25	30	35	35	35
Fin Height	100	120	175	225	225	225	225

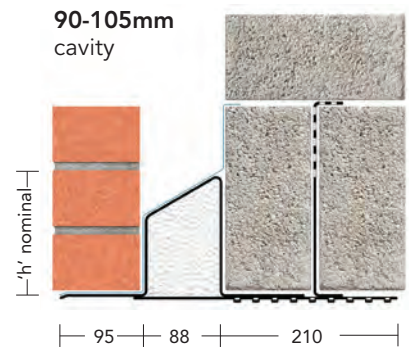

L1/S 110 WIL 215	Cavity widths 110-125mm				
Manufactured length 150mm increments	600- 1500	1650- 1800	1950- 2100	2250- 3000	3150- 4050
Height 'h'	97	125	145	193	193
Thickness	2.5	2.5	2.5	2.9	3.2
Total UDL kN 3:1	25	25	30	35	40
Total UDL kN 19:1	20	20	25	30	35
Fin Height	120	140	175	225	225

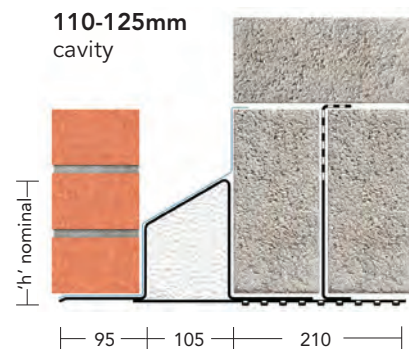

L1/S 150 WIL 215	Cavity widths 150-165mm				
Manufactured length 150mm increments	600- 1500	1650- 1800	1950- 2100	2250- 3000	3150- 4050
Height 'h'	100	130	173	199	199
Thickness	2.5	2.5	2.5	2.9	3.2
Total UDL kN 3:1	25	25	30	35	40
Total UDL kN 19:1	20	20	25	30	35
Fin Height	120	140	175	225	225

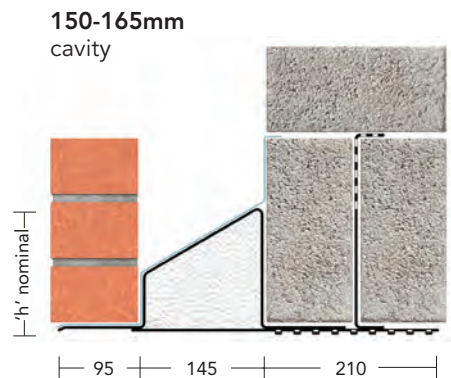

Please note other cavity widths and loading conditions are available.

Cavity Wall - Wide Inner Leaf 215

Available for cavity widths from 50mm to 165mm

OUTER LEAF	INNER LEAF
102mm	215mm



L1/HD WIL 215

Lintels may be propped to facilitate speed of construction. See Lintel Installation on page 6. Inner leaf block should not overhang the lintel flange by more than 25mm.

DAMP PROOFING

Provide a damp proof course over all lintels. For more guidance please see our on-line brochures or contact our technical team.

Heavy Duty Load

For 215mm wide inner leaf blockwork.

L1/HD 100 WIL 215	Cavity widths 90-105mm		
Manufactured length 150mm increments	600-1500	1650-1800	1950-2100
Height 'h'	145	200	200
Thickness	2.5	2.5	2.9
Total UDL kN 3:1	40	45	50
Total UDL kN 19:1	35	40	45
Fin Height	175	225	225

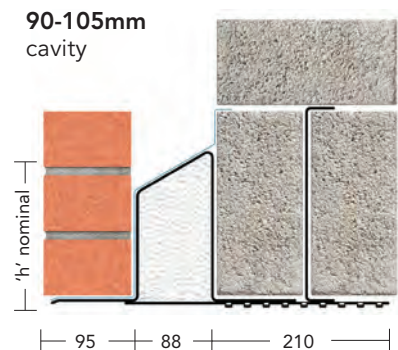

L1/HD 110 WIL 215	Cavity widths 110-125mm		
Manufactured length 150mm increments	600-1500	1650-1800	1950-2100
Height 'h'	145	195	195
Thickness	2.5	2.9	3.2
Total UDL kN 3:1	40	45	50
Total UDL kN 19:1	35	40	45
Fin Height	175	225	225

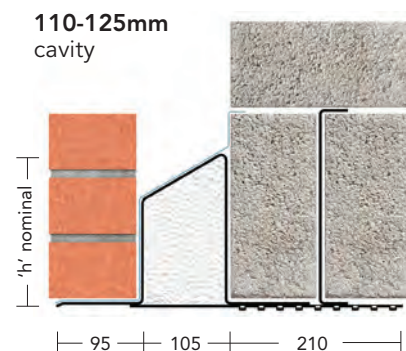

L1/HD 150 WIL 215	Cavity widths 150-165mm		
Manufactured length 150mm increments	600-1500	1650-1800	1950-2100
Height 'h'	173	199	199
Thickness	2.5	2.9	3.2
Total UDL kN 3:1	40	45	50
Total UDL kN 19:1	35	40	45
Fin Height	175	225	225

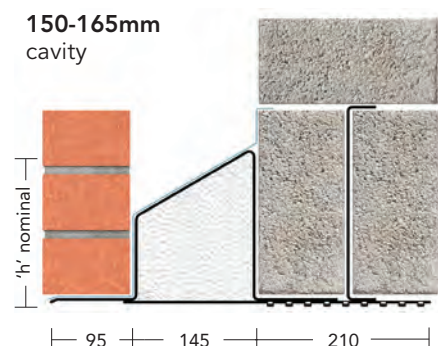

Please note other cavity widths and loading conditions are available.

Cavity Wall - Wide Inner Leaf 215

Available for cavity widths from 50mm to 165mm

OUTER LEAF

INNER LEAF

102mm

215mm



L6/ WIL 215

To achieve loading figures lintel must be laterally restrained. Lintels may be propped to facilitate speed of construction. See Lintel Installation on page 6.

DAMP PROOFING

Provide a damp proof course over all lintels. For more guidance please see our on-line brochures or contact our technical team.

Extreme Load

For 215mm wide inner leaf blockwork.

L6/100 WIL 215		Cavity widths 90-105mm				
Manufactured length (mm) to customer requirements	600-4800	5200	5400	5800	6200	6600
End Bearing	200	200	200	200	200	200
Total UDL kN 19:1	80	70	62	55	45	40

90-105mm cavity

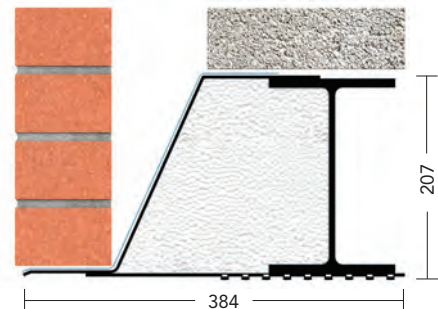

L6/110 WIL 215		Cavity widths 110-125mm				
Manufactured length (mm) to customer requirements	600-4800	5200	5400	5800	6200	6600
End Bearing	200	200	200	200	200	200
Total UDL kN 19:1	80	70	62	55	45	40

110-125mm cavity

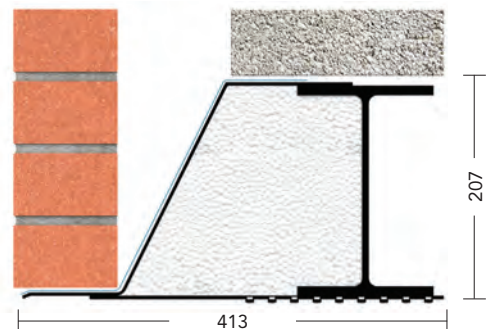

L6/150 WIL 215		Cavity widths 150-165mm				
Manufactured length (mm) to customer requirements	600-4800	5200	5400	5800	6200	6600
End Bearing	200	200	200	200	200	200
Total UDL kN 19:1	80	70	62	55	45	40

150-165mm cavity

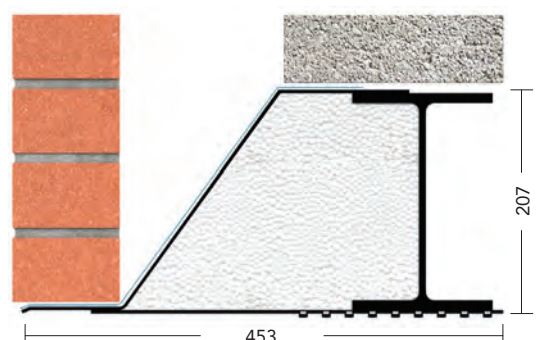







Please note other cavity widths and loading conditions are available.

Wide Outer Leaf Lintel

125 - 150mm
OUTER LEAF
215mm
OUTER LEAF



Please use this table to identify the Lintel code required based on cavity width and loading. Contact our technical department for more details on these lintel options. Please note that only a selection of the range is illustrated in this manual.

125mm - 150mm Outer Leaf

		LOADING						
CAVITY WIDTH	Cavity Width (mm)	Standard	Heavy Duty	Heavy Duty	Extra Heavy Duty	Extra Heavy Duty	Extreme	
	*	50 - 65	L1/S 50 WOL	L1/HD 50 WOL	L1/XHD 50 WOL	L5/ 50 WOL	L5/XHD 50 WOL	L6/ 50 WOL
	*	70 - 85	L1/S 75 WOL	L1/HD 75 WOL	L1/XHD 75 WOL	L5/ 75 WOL	L5/XHD 75 WOL	L6/ 75 WOL
		90 - 105	L1/S 100 WOL	L1/HD 100 WOL	L1/XHD 100 WOL	L5/ 100 WOL	L5/XHD 100 WOL	L6/ 100 WOL
		110 - 125	L1/S 110 WOL	L1/HD 110 WOL	L1/XHD 110 WOL	L5/ 110 WOL	L5/XHD 110 WOL	L6/ 110 WOL
	*	130 - 145	L1/S 130 WOL	L1/HD 130 WOL	L1/XHD 130 WOL	L5/ 130 WOL	L5/XHD 130 WOL	L6/ 130 WOL
		150 - 165	L1/S 150 WOL	L1/HD 150 WOL	L1/XHD 150 WOL	L5/ 150 WOL	L5/XHD 150 WOL	L6/ 150 WOL
								

*Cavity widths with asterisk are not illustrated in this manual - contact our technical department for details.

215mm Outer Leaf

		LOADING	
CAVITY WIDTH	Cavity Width (mm)	Standard	
	*	50 - 65	L1/S 50 WOL 215
	*	70 - 85	L1/S 75 WOL 215
		90 - 105	L1/S 100 WOL 215
		110 - 125	L1/S 110 WOL 215
	*	130 - 145	L1/S 130 WOL 215
		150 - 165	L1/S 150 WOL 215
			

*Cavity widths with asterisk are not illustrated in this manual - contact our technical department for details.

Cavity Wall - Wide Outer Leaf

Available for cavity widths from 50mm to 165mm

OUTER LEAF

125mm -
150mm

INNER LEAF

100mm



L1/S WOL

To achieve loading figures lintel must be built in with blockwork as shown. Maximum overhang of 30mm on outer leaf. Lintels may be propped to facilitate speed of construction. See Lintel Installation on page 6.

DAMP PROOFING

Provide a damp proof course over all lintels. For more guidance please see our on-line brochures or contact our technical team.

Standard Load

For 150mm wide outer leaf blockwork/stonework.

L1/S 100 WOL For cavity widths 90-105mm						
Manufactured length 150mm increments	600- 1350	1500- 1650	1800- 2100	2250- 2700	2850- 3000	3150- 3600
Height 'h'	93	110	162	188	188	188
Thickness	2.5	2.5	2.5	2.9	2.9	3.2
Total UDL kN 3:1	14	15	23	30	32	30
Total UDL kN 19:1	11	13	18	22	30	26

90-105mm cavity

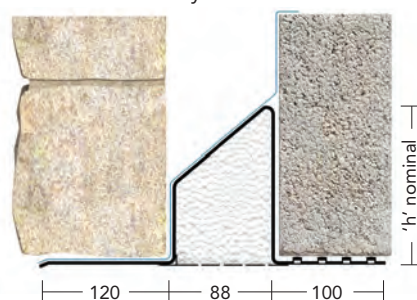

L1/S 110 WOL For cavity widths 110-125mm						
Manufactured length 150mm increments	600- 1350	1500- 1650	1800- 2100	2250- 2700	2850- 3000	3150- 3600
Height 'h'	95	107	142	185	185	185
Thickness	2.5	2.5	2.5	2.9	3.2	3.2
Total UDL kN 3:1	14	15	23	30	32	30
Total UDL kN 19:1	11	13	18	22	30	26

110-125mm cavity

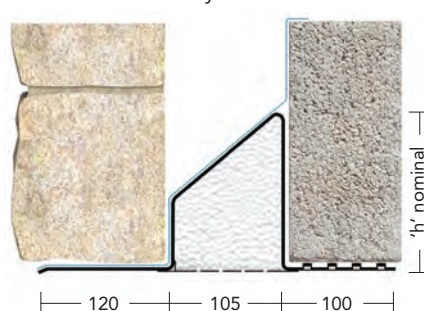

L1/S 150 WOL For cavity widths 150-165mm						
Manufactured length 150mm increments	600- 1350	1500- 1650	1800- 2100	2250- 2700	2850- 3000	3150- 3600
Height 'h'	88	115	168	168	168	168
Thickness	2.5	2.5	2.5	2.9	3.2	3.2
Total UDL kN 3:1	14	15	23	30	32	30
Total UDL kN 19:1	11	13	18	22	30	26

150-165mm cavity

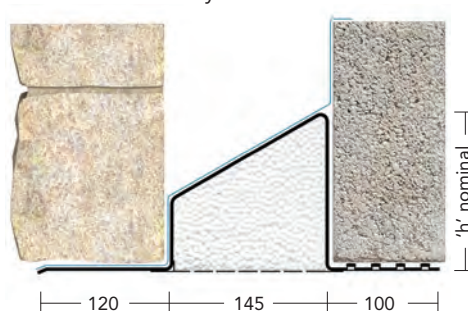

Please note other cavity widths and loading conditions are available.

Cavity Wall - Wide Outer Leaf

Available for cavity widths from 50mm to 165mm

OUTER LEAF	INNER LEAF
125mm - 150mm	100mm



L1/HD WOL

To achieve loading figures lintel must be built in with blockwork as shown. Maximum overhang of 30mm on outer leaf. Lintels may be propped to facilitate speed of construction. See Lintel Installation on page 6.

DAMP PROOFING

Provide a damp proof course over all lintels. For more guidance please see our on-line brochures or contact our technical team.

Heavy Duty Load

For 150mm wide outer leaf blockwork/stonework.

L1/HD 100 WOL Cavity widths 90-105mm				
Manufactured length 150mm increments	600-1350	1500-1800	1950-2100	2250-2700
Height 'h'	123	148	188	188
Thickness	2.9	2.9	2.9	3.2
Total UDL kN 3:1	20	30	30	36
Total UDL kN 19:1	17	25	25	32

90-105mm cavity

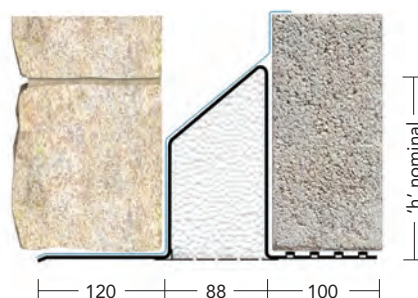

L1/HD 110 WOL Cavity widths 110-125mm				
Manufactured length 150mm increments	600-1350	1500-1800	1950-2100	2250-2700
Height 'h'	113	148	195	195
Thickness	2.9	2.9	2.9	3.2
Total UDL kN 3:1	20	30	30	36
Total UDL kN 19:1	17	25	25	32

110-125mm cavity

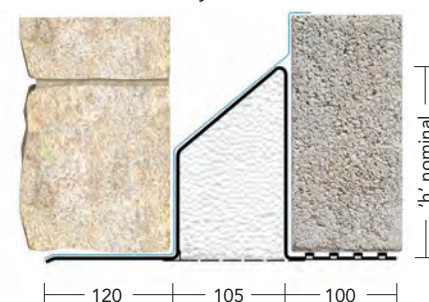

L1/HD 150 WOL Cavity widths 150-165mm				
Manufactured length 150mm increments	600-1350	1500-1800	1950-2100	2250-2700
Height 'h'	113	168	180	200
Thickness	2.9	2.9	2.9	3.2
Total UDL kN 3:1	20	30	30	36
Total UDL kN 19:1	17	25	25	32

150-165mm cavity

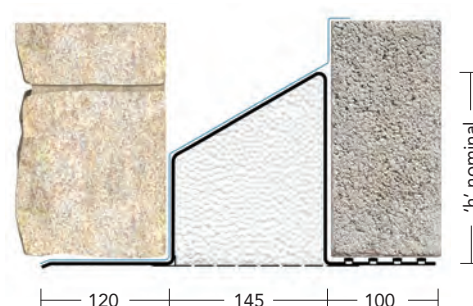

Please note other cavity widths and loading conditions are available.

Cavity Wall - Wide Outer Leaf

Available for cavity widths from 50mm to 165mm

OUTER LEAF

125mm -
150mm

INNER LEAF

100mm



L1/XHD WOL

Lintels may be propped to facilitate speed of construction. See Lintel Installation on page 6. Blockwork built tight against inner face of the lintel. Maximum overhang of 30mm on outer leaf. Place mortar bed on top of blockwork before floor units are laid to provide even distribution of load.

DAMP PROOFING

Provide a damp proof course over all lintels. For more guidance please see our on-line brochures or contact our technical team.

Heavy Duty Load

For 150mm wide outer leaf blockwork/stonework.

L1/XHD 100 WOL Cavity widths 90-105mm

Manufactured length 150mm increments	600- 1500	1650- 1800	1950- 2100
Height 'h'	165	188	188
Thickness	3.2	3.2	3.2
Total UDL kN 3:1	45	45	50
Total UDL kN 19:1	40	40	40

90-105mm cavity

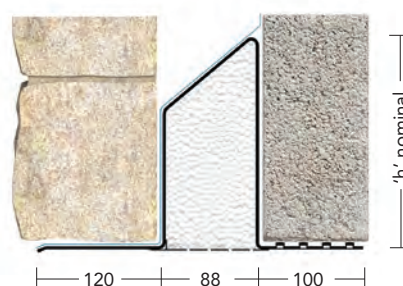

L1/XHD 110 WOL Cavity widths 110-125mm

Manufactured length 150mm increments	600- 1500	1650- 1800	1950- 2100
Height 'h'	195	195	195
Thickness	3.2	3.2	3.2
Total UDL kN 3:1	45	45	50
Total UDL kN 19:1	40	40	40

110-125mm cavity

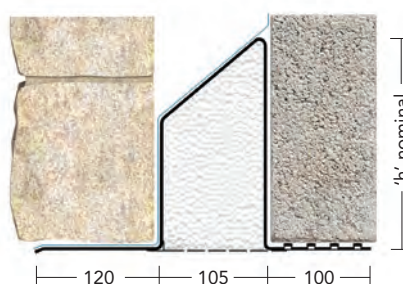

L1/XHD 150 WOL Cavity widths 150-165mm

Manufactured length 150mm increments	600- 1500	1650- 1800	1950- 2100
Height 'h'	180	200	200
Thickness	3.2	3.2	3.2
Total UDL kN 3:1	45	45	50
Total UDL kN 19:1	40	40	40

150-165mm cavity

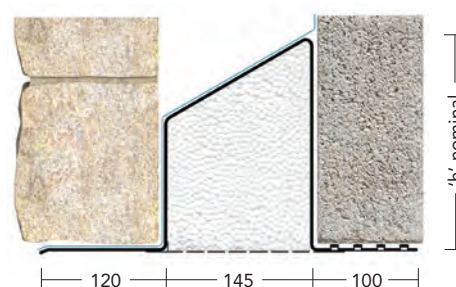

Please note other cavity widths and loading conditions are available.

Cavity Wall - Wide Outer Leaf

Available for cavity widths from 50mm to 165mm

OUTER LEAF	INNER LEAF
125mm - 150mm	100mm



L5/ WOL

To achieve loading figures lintel must be built in with blockwork as shown. Maximum overhang of 30mm on outer leaf. Ensure all perpendicular and horizontal joints are filled with mortar. Place mortar bed on top of blockwork before floor units are laid to provide even distribution of load. Lintels may be propped to facilitate speed of construction. See Lintel Installation on page 6.

DAMP PROOFING

Provide a damp proof course over all lintels. For more guidance please see our on-line brochures or contact our technical team.

Extra Heavy Duty Load

For 150mm wide outer leaf blockwork/stonework.

L5/100 WOL	Cavity widths 90-105mm				
Manufactured length 150mm increments	600-1500	1650-2100	2250-3000	3150-4050	4200-4800
Height 'h'	229	229	229	229	229
Thickness	2.9	2.9	2.9	3.2	3.2
Total UDL kN 19:1	70	60	50	45	40

90-105mm cavity

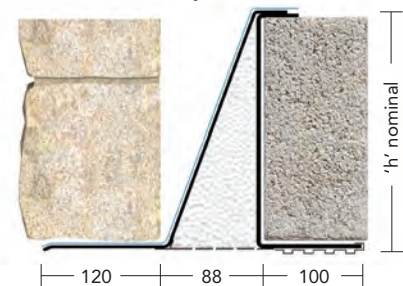

L5/110 WOL	Cavity widths 110-125mm				
Manufactured length 150mm increments	600-1500	1650-2100	2250-3000	3150-4050	4200-4800
Height 'h'	229	229	229	229	229
Thickness	2.9	2.9	2.9	3.2	3.2
Total UDL kN 19:1	70	60	50	45	40

110-125mm cavity

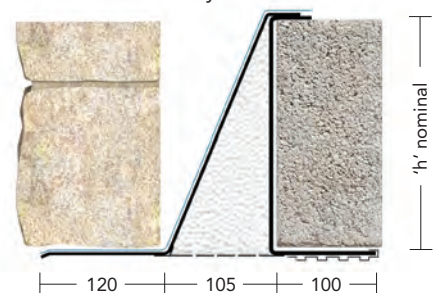

L5/150 WOL	Cavity widths 150-165mm				
Manufactured length 150mm increments	600-1500	1650-2100	2250-3000	3150-4050	4200-4800
Height 'h'	229	229	229	229	229
Thickness	2.9	2.9	2.9	3.2	3.2
Total UDL kN 19:1	70	60	50	45	40

150-165mm cavity

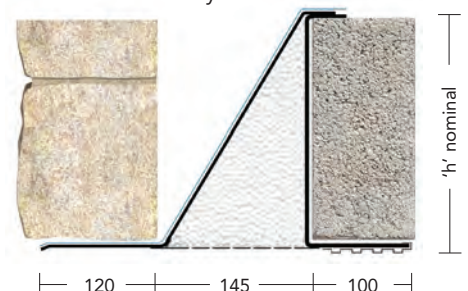

Please note other cavity widths and loading conditions are available.

Cavity Wall - Wide Outer Leaf

Available for cavity widths from 50mm to 165mm

OUTER LEAF

125mm -
150mm

INNER LEAF

100mm



L5/XHD WOL

To achieve loading figures lintel must be built in with blockwork as shown. Maximum overhang of 30mm on outer leaf. Ensure all perpendicular and horizontal joints are filled with mortar. Place mortar bed on top of blockwork before floor units are laid to provide even distribution of load. Lintels may be propped to facilitate speed of construction. See Lintel Installation on page 6.

DAMP PROOFING

Provide a damp proof course over all lintels. For more guidance please see our on-line brochures or contact our technical team.

Extra Heavy Duty Load

For 150mm wide outer leaf blockwork/stonework.

L5/XHD 100 WOL Cavity widths 90-105mm

Manufactured length 150mm increments	600- 1800	1950- 2400	2550- 3000	3150- 3600
Height 'h'	235	235	235	235
Thickness Inner	5.0	5.0	5.0	5.0
Thickness Outer	2.9	2.9	2.9	3.2
Total UDL kN 19:1	100	90	80	65

90-105mm cavity

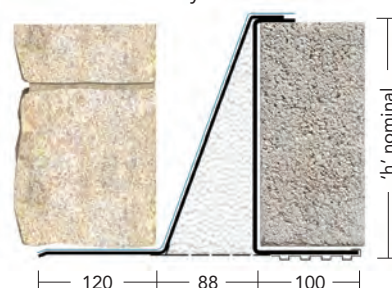

L5/XHD 110 WOL Cavity widths 110-125mm

Manufactured length 150mm increments	600- 1800	1950- 2400	2550- 3000	3150- 3600
Height 'h'	235	235	235	235
Thickness Inner	5.0	5.0	5.0	5.0
Thickness Outer	2.9	2.9	2.9	3.2
Total UDL kN 19:1	100	90	80	65

110-125mm cavity

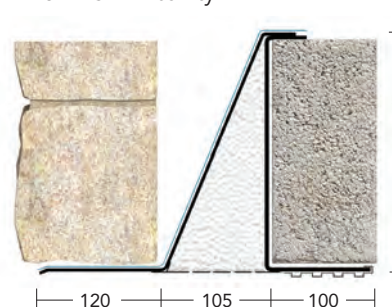

L5/XHD 150 WOL Cavity widths 150-165mm

Manufactured length 150mm increments	600- 1800	1950- 2400	2550- 3000	3150- 3600
Height 'h'	235	235	235	235
Thickness Inner	5.0	5.0	5.0	5.0
Thickness Outer	2.9	2.9	2.9	3.2
Total UDL kN 19:1	100	90	80	65

150-165mm cavity

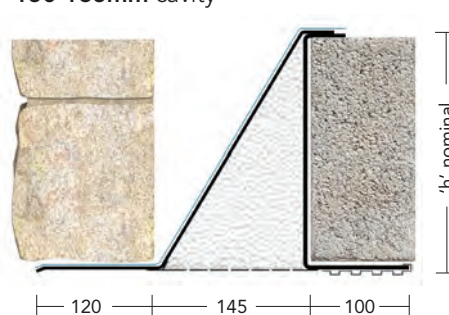

Please note other cavity widths and loading conditions are available.

Cavity Wall - Wide Outer Leaf

Available for cavity widths from 50mm to 165mm

OUTER LEAF	INNER LEAF
125mm - 150mm	100mm



L6/ WOL

Maximum overhang of 30mm on outer leaf. Ensure all perpendicular and horizontal joints are filled with mortar. Place mortar bed on top of blockwork before floor units are laid to provide even distribution of load. Lintels may be propped to facilitate speed of construction. See Lintel Installation on page 6.

DAMP PROOFING

Provide a damp proof course over all lintels. For more guidance please see our on-line brochures or contact our technical team.

Extreme Load

For 150mm wide outer leaf blockwork/stonework.

L6/100 WOL	Cavity widths 90-105mm					
Manufactured length (mm) to customer requirements	600-4800	5200	5400	5800	6200	6600
End Bearing	200	200	200	200	200	200
Total UDL kN 19:1	80	70	62	55	45	40

90-105mm cavity

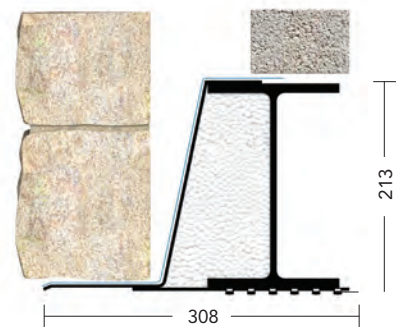

L6/110 WOL	Cavity widths 110-125mm					
Manufactured length (mm) to customer requirements	600-4800	5200	5400	5800	6200	6600
End Bearing	200	200	200	200	200	200
Total UDL kN 19:1	80	70	62	55	45	40

110-125mm cavity

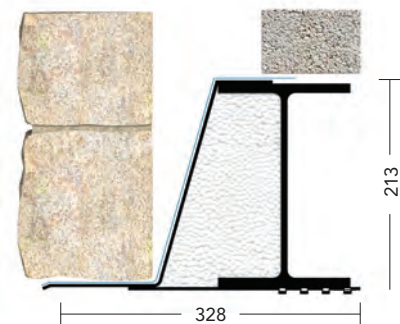

L6/150 WOL	Cavity widths 150-165mm					
Manufactured length (mm) to customer requirements	600-4800	5200	5400	5800	6200	6600
End Bearing	200	200	200	200	200	200
Total UDL kN 19:1	80	70	62	55	45	40

150-165mm cavity

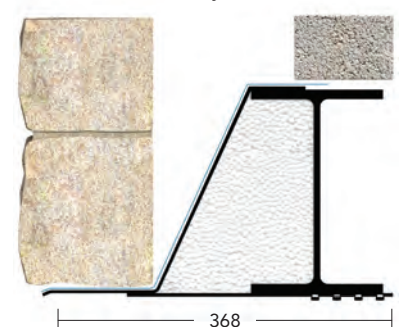

Please note other cavity widths and loading conditions are available.

Cavity Wall - Wide Outer Leaf 215

Available for cavity widths from 50mm to 165mm

OUTER LEAF

215mm

INNER LEAF

100mm



L1/S WOL 215

To achieve loading figures lintel must be built in with blockwork as shown. Maximum overhang of 30mm on outer leaf. Extended fin 225mm high for lintels greater than 2100mm in length. Lintels may be propped to facilitate speed of construction. See Lintel Installation on page 6.

DAMP PROOFING

Provide a damp proof course over all lintels. For more guidance please see our on-line brochures or contact our technical team.

Standard Load

For 215mm wide outer leaf blockwork/stonework.

L1/S 100 WOL 215		Cavity widths 90-105mm				
Manufactured length 150mm increments	600- 1200	1350- 1500	1650- 2100	2250- 2550	2700- 3000	3150- 3600
Height 'h'	103	140	163	203	203	203
Thickness	2.9	2.9	2.9	2.9	3.2	3.2
Total UDL kN 3:1	30	30	30	40	40	35
Total UDL kN 19:1	22	22	22	35	35	32
Fin Height	100	120	175	225	225	225

90-105mm cavity

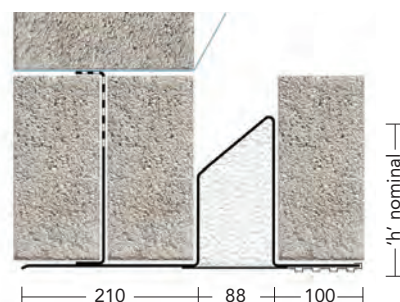

L1/S 110 WOL 215		Cavity widths 110-125mm			
Manufactured length 150mm increments	600- 1500	1650- 2100	2250- 2550	2700- 3000	3150- 3600
Height 'h'	130	145	195	195	195
Thickness	2.9	2.9	2.9	3.2	3.2
Total UDL kN 3:1	30	30	35	35	32
Total UDL kN 19:1	20	22	30	30	28
Fin Height	120	175	225	225	225

110-125mm cavity

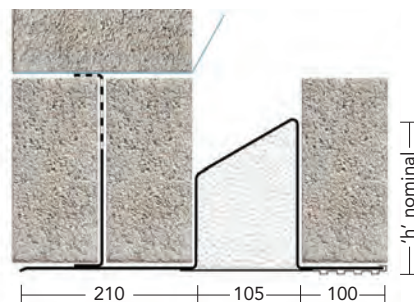

L1/S 150 WOL 215		Cavity widths 150-165mm			
Manufactured length 150mm increments	600- 1500	1650- 2100	2250- 2550	2700- 3000	3150- 3600
Height 'h'	118	160	180	180	180
Thickness	2.9	2.9	2.9	3.2	3.2
Total UDL kN 3:1	30	30	35	35	30
Total UDL kN 19:1	20	22	30	30	25
Fin Height	120	175	225	225	225

150-165mm cavity

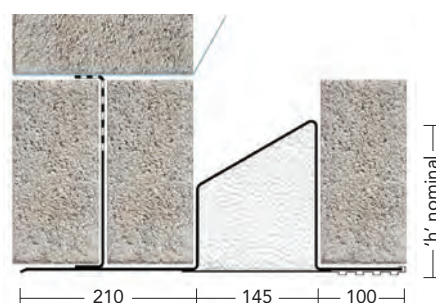

Please note other cavity widths and loading conditions are available.

Eaves Lintel

100mm
INNER LEAF

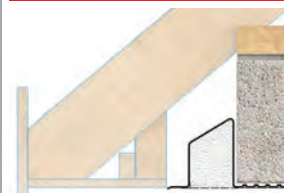

L1/E lintels are designed to provide support over openings at eaves level. The eaves lintel has a shortened outer flange to allow the underside of the soffit board to be positioned tight against the window frame. It must be noted that brickwork cannot be built onto the outer flange of an eaves lintels. Masonry is built on the inner leaf only.

The loading figures are achieved by considering the lintel and masonry as a composite unit.

The lintel must have a minimum end bearing of 150mm on each side of the opening bedded on mortar. Level the lintel along its length and across its width. The lintel must be positioned to ensure that the masonry is built against

the vertical upstand of the lintel. Masonry should be bedded on mortar and all perpendicular joints filled with mortar.

A continuous timber wall plate must extend along the masonry immediately above the lintel. Lintel may be propped to facilitate speed of construction. A plaster key is incorporated into the inner leaf of the lintel.

The IG Eaves lintel also incorporates a thermal break plate on the underside of the lintel for superior structural performance.

L1/E 100	Cavity widths 90-125mm			
Manufactured length 150mm increments	600- 1500	1650- 2100	2250- 2400	2550- 2700
Height 'h'	106	144	163	164
Thickness	1.8	2.0	2.0	2.5
Total UDL kN 19:1	18	20	22	25

90-125mm cavity

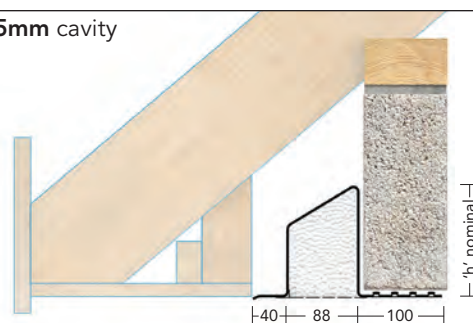

Poro-Cav Lintels

**300mm +
WALL WIDTHS**

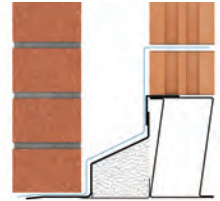

Unique to the Porotherm Masonry System.

The Poro-Cav Lintel features a unique, patented 'thermal break plate' that enhances thermal performance.

The inner leaf is supported through a standard IG Box lintel with factory fitted lateral restraint clips. The outer leaf support comes from the uniquely designed outer lintel, which is easily clipped into position using the lateral restraint clip prefixed to the inner box lintel.

This system provides resistance to rotation during loading onsite.

WHAT IS POROTHERM?

Porotherm is a precision engineered modern clay block walling system. The system has revolutionised the construction industry through fast and dry construction with the benefits of high strength and thermal performance.

Through the use of 1mm mortar beds using the special adhesive in comparison to the conventional 10mm joints, the Porotherm System brings many benefits associated with efficiency, quality and value retention.

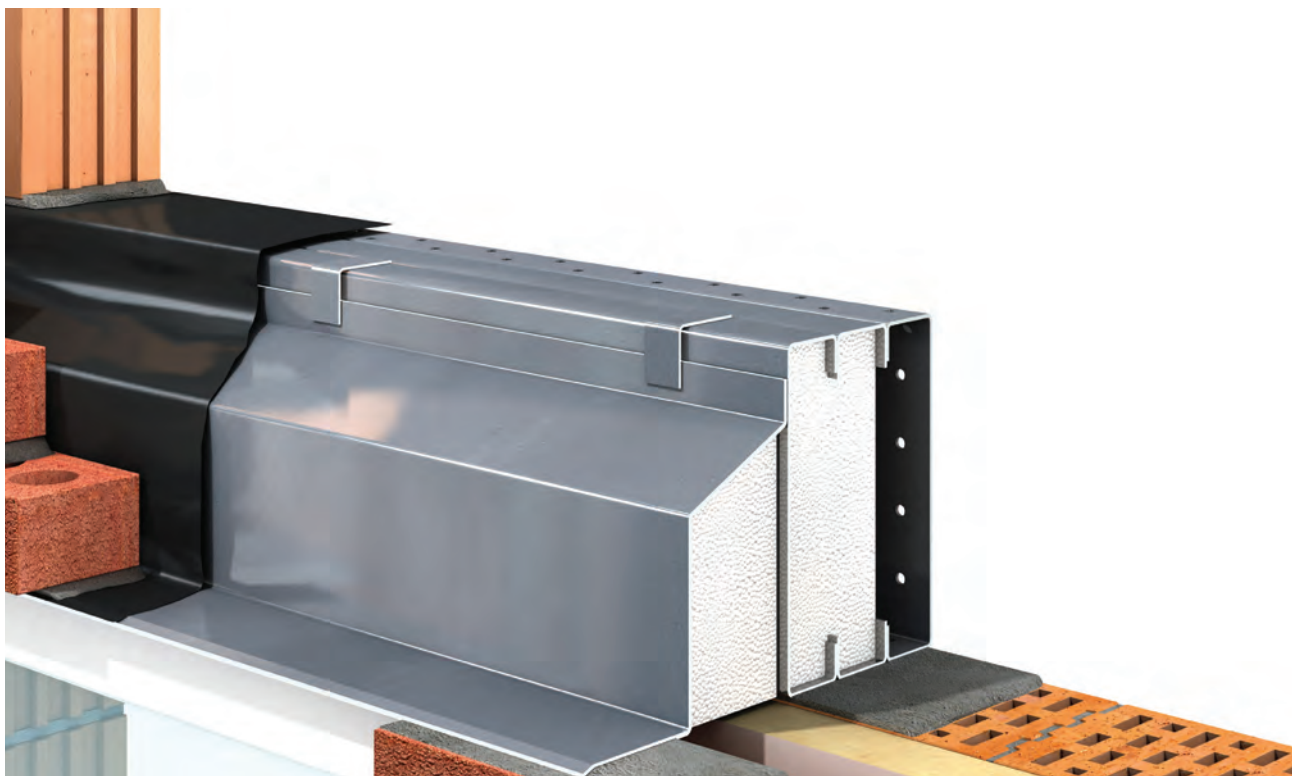

Cavity Wall - Poro-Cav

DAMP PROOFING Provide a damp proof course over all lintels. For more guidance please see our on-line brochures or contact our technical team.

WALL WIDTHS

300mm +



PCI L100 For cavity wall inner leaf 100mm

Manufactured length	600-1800	1950-2400	2550-2700	2850-3000
Height 'h'	150	150	150	215
Internal leaf specify PCI/K-100 (to suit 100mm Inner Leaf)				
Total UDL kN	30	25	20	30
External leaf specify PCO/K-90 (to suit 90-105mm cavity)				
Total UDL kN	5	8	9	12

For wider cavities and heavy loadings contact our technical department

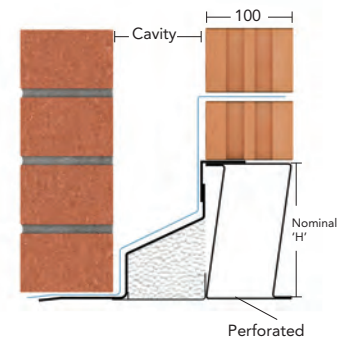

PCI L140 For cavity wall inner leaf 140mm

Manufactured length	600-1800	1950-2400	2550-2700	2850-3000
Height 'h'	150	150	150	215
Internal leaf specify PCI/K-140 (to suit 140mm Inner Leaf)				
Total UDL kN	30	25	20	35
External leaf specify PCO/K-90 (to suit 90-105mm cavity)				
Total UDL kN	5	8	9	12

For wider cavities and heavy loadings contact our technical department

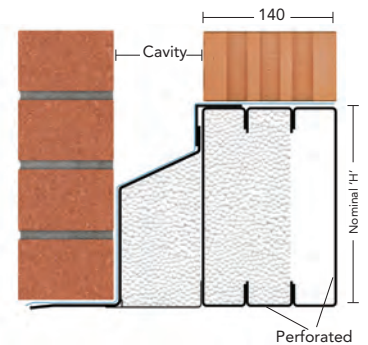

PCI L190 For cavity wall inner leaf 190mm

Manufactured length	600-1800	1950-2400	2550-2700	2850-3000
Height 'h'	150	150	150	215
Internal leaf specify PCI/K-190 (to suit 190mm Inner Leaf)				
Total UDL kN	30	25	20	35
External leaf specify PCO/K-90 (to suit 90-105mm cavity)				
Total UDL kN	5	8	9	12

For wider cavities and heavy loadings contact our technical department

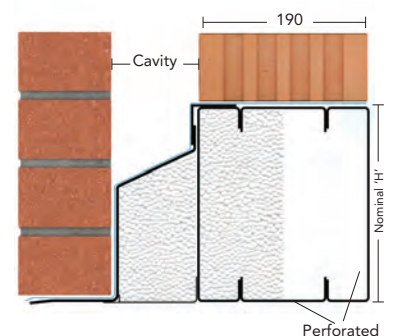

Timber Frame Lintel

**102 mm
OUTER LEAF**

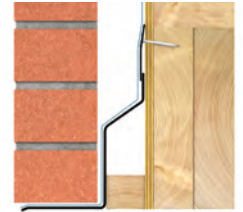

Designed for use in timber frame construction the L7 lintels provide support to the outer leaf to brickwork over openings.

INSTALLATION

Installation of IG's L7, L7/HD and L7/XHD are all similar.

All Timber frame lintels must be installed with restraining clips and a timber pinch batten to prevent rotation of the lintel during the building stage. Propping may be used to facilitate speed of construction.

To achieve the loading figures shown, the L7 lintel must be secured with restraining clips and a timber pinch batten (not supplied) must be used to prevent lateral deflection (rotation) during the building stage. A single timber pinch batten 300mm long at mid span will be sufficient.

IG timber frame restraint clips are supplied free of charge and must be fixed to the timber frame structure by 3.3mm x 50mm galvanised nails. Allowance should be made for the movement of the timber frame structure due to settlement and shrinkage. Lateral restraint clip should be placed at 500mm centres each side of mid span.

SPECIFICATION

For material specifications, please see page 5. Architectural specification clauses and full NBS plus specifications are available at www.iglintels.com

Position of lintel restraint clips

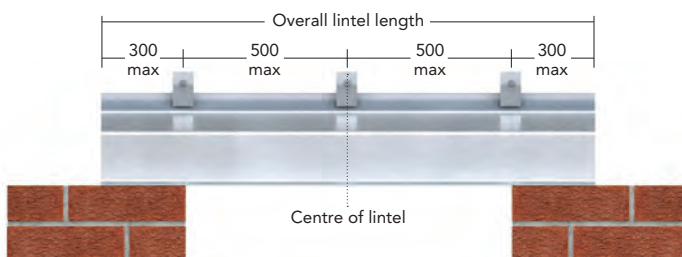

Clearance

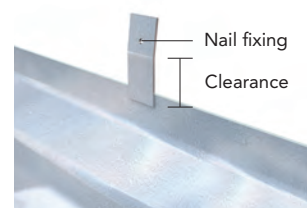

EXTRA HEAVY DUTY LOADS

L7/XHD

For use with timber frame construction. The L7/XHD lintel must be used in conjunction with lateral restraint clips as shown, to prevent twisting. The L7/XHD range can be supplied to suit wider cavities: e.g. specify L7/XHD 75, L7/XHD 100. Lintels may be propped to facilitate speed of construction. See Lintel Installation on page 6.

Cavity Wall - Timber Frame

Available for cavity widths **50mm to 100mm**

OUTER LEAF	INNER LEAF
102mm	100mm - 150mm



L7

For use with timber frame construction. The L7 lintel must be used in conjunction with lateral restraint clips and a tight fitting timber batten, as shown, to prevent twisting. The L7 range can be supplied to suit wider cavities: e.g. specify L7 75, L7 100. Lintels may be propped to facilitate speed of construction. See Lintel Installation on page 6.

DAMP PROOFING

Provide a damp proof course over all lintels. For more guidance please see our on-line brochures or contact our technical team.

Standard Load

L7/50	Cavity widths 50-65mm				
Manufactured length 150mm increments	600-1200	1350-1800	1950-2400	2550-3600	3750-4800
Height 'h'	110	110	135	175	250
Thickness	2.0	2.5	2.5	2.8	3.0
Total UDL kN	4	5	5	9	12

For installation please refer to installation notes on page 6.

50-65mm cavity

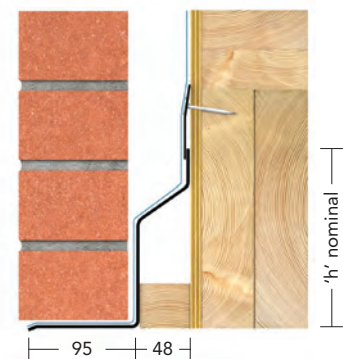

L7/75 & L7/100	Specified cavity width			
Manufactured length 150mm increments	600-1650	1800-2400	2550-3000	3150-4800
Height 'h'	118	170	204	260
Thickness	2.5	2.5	2.9	3.2
Total UDL kN	5	8	9	12

For installation please refer to installation notes on page 6.

Specified cavity width

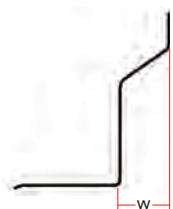
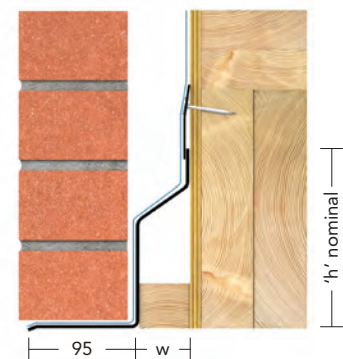

L7/75 W = 68mm Cavity widths 70-80mm
L7/100 W = 88mm Cavity widths 90-100mm

Please note other cavity widths and loading conditions are available.

Cavity Wall - Timber Frame

Available for cavity widths 50mm to 100mm



OUTER LEAF

102mm

INNER LEAF

100mm -
150mm

L7/HD

For use with timber frame construction. The L7/HD lintel must be used in conjunction with lateral restraint clips and a tight fitting timber batten, as shown, to prevent twisting. The L7/HD range can be supplied to suit wider cavities: e.g. specify L7/HD 75, L7/HD 100. Lintels may be propped to facilitate speed of construction. See Lintel Installation on page 6.

DAMP PROOFING

Provide a damp proof course over all lintels. For more guidance please see our on-line brochures or contact our technical team.

Heavy Duty Load

L7/HD 50	Cavity widths 50-65mm		
Manufactured length 150mm increments	600- 1650	1800- 2400	2550- 3000
Height 'h'	163	202	260
Thickness	2.5	2.9	3.2
Total UDL kN	10	12	12

For installation please refer to installation notes on page 6.

50-65mm cavity

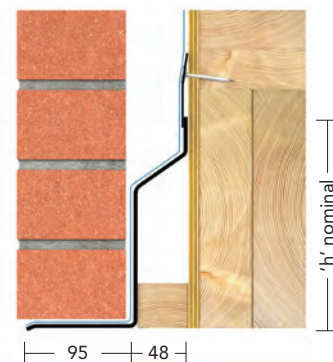

L7/HD 75 & L7/HD 100	Specified cavity width		
Manufactured length 150mm increments	600- 1650	1800- 2400	2550- 3000
Height 'h'	170	204	260
Thickness	2.5	2.9	3.2
Total UDL kN	10	12	12

For installation please refer to installation notes on page 6.

Specified cavity width

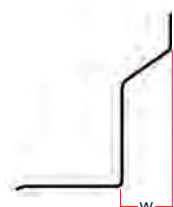
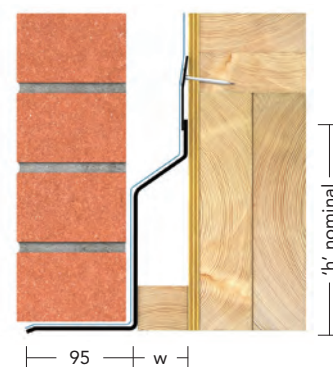

L7/HD 75 W = 68mm Cavity widths 70-80mm

L7/HD 100 W = 88mm Cavity widths 90-100mm

Please note other cavity widths and loading conditions are available.

Single Leaf Lintel

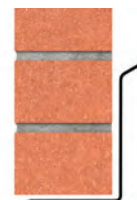
**102mm
SINGLE LEAF**

Standard Load

L10			
Manufactured length 150mm increments	600- 1200	1350- 1800	1950- 2700
Height 'h'	60	110	210
Thickness	3.0	3.0	3.0
Total UDL kN	4	8	10

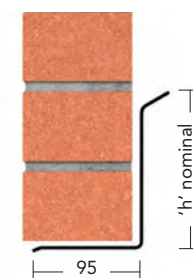

Longer lengths available. Used to support the outer leaf of cavity wall construction. The L10 lintel can be supplied with no top bend. Lintels may be propped to facilitate speed of construction. See Lintel Installation on page 6.

Heavy Duty Load

L11			
Manufactured length 150mm increments	600- 1800	1950- 2400	2550- 3000
Height 'h'	150	225	225
Thickness	2.5	2.5	3.0
Total UDL kN	16	20	22

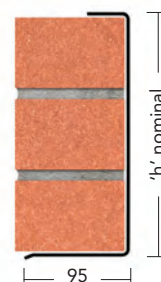
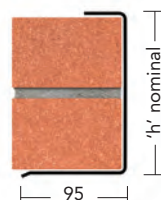
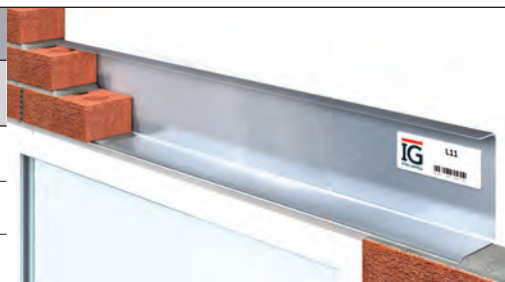

Longer lengths available. For use to support single leaf or outer leaf of cavity wall construction. To achieve loading figures, lintel must be built in with brickwork as shown. Lintels may be propped to facilitate speed of construction. See Lintel Installation on page 6.

Solid Wall Box Lintels

100 -215mm
WALL DEPTH

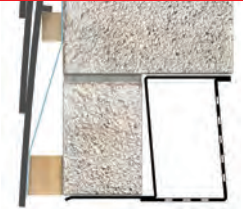

Box lintels can be used for internal or external openings and with a variation of wall thicknesses. The IG box lintel has perforations along its length acting as a plaster key. As an optional extra IG box lintels can be insulated. The IG box lintel is designed to carry the full load of wet masonry as soon as it is installed.

INSTALLATION

Box Lintels must have a minimum end bearing of 150mm on each side of the opening, bedded on mortar. Level the lintel along its length and across its width. Masonry built must be laid on a mortar bed and all perpendicular joints to be filled with mortar.

Care should be taken to avoid shock loading on box lintels when used in conjunction with concrete floors or other heavy units.

CODE REF	WALL DEPTH
BOX 75	100mm
BOX 100	100mm
BOX 140	150mm
BOX 200	215mm

SPECIFICATION

For material specifications please see page 5. Architectural specification clauses and full NBS plus specifications are available at www.iglintels.com

BOX 75		
Manufactured length 150mm increments	600- 1650	1800
Height 'h'	75	75
Thickness	1.6	2.0
Total UDL kN	15	10

Standard Load

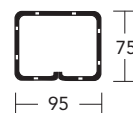

Used to support openings in 100mm wide walls.

Solid Wall - Box Lintels

Available for wall widths from 100mm to 215mm

WALL WIDTH
100mm - 215mm



BOX 100

Used to support openings in 100mm wide walls. Lintels may be propped to facilitate speed of construction. See Lintel Installation on page 6.

Standard Load

BOX 100							
Manufactured length 150mm increments	600- 1500	1650- 2100	2250- 2400	2550- 2700	2850- 3600	3750- 4200	4350- 4800
Height 'h'	75	150	150	150	215	215	215
Thickness	1.6	2.0	2.0	2.0	2.5	2.5	2.5
Total UDL kN	15	30	25	20	30	25	20

Used to support openings in 100mm wide walls.

Standard Load

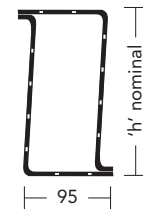

BOX 140							
Manufactured length 150mm increments	600- 1500	1650- 2100	2250- 2400	2550- 2700	2850- 3600	3750- 4200	4350- 4800
Height 'h'	150	150	150	150	215	215	215
Thickness	1.6	2.0	2.0	2.0	2.5	2.5	2.5
Total UDL kN	15	30	25	20	35	30	25

Used to support openings in 150mm wide walls.

Standard Load

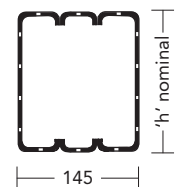

BOX 200							
Manufactured length 150mm increments	600- 1500	1650- 2100	2250- 2400	2550- 2700	2850- 3600	3750- 4200	4350- 4800
Height 'h'	150	150	150	150	215	215	215
Thickness	1.6	2.0	2.0	2.0	2.5	2.5	2.5
Total UDL kN	15	30	25	20	30	25	20

The flange of the BOX 200 is designed to support a nominal masonry load only up to a maximum of 3kN per metre run. Used to support openings in 215mm wide walls.

Standard Load

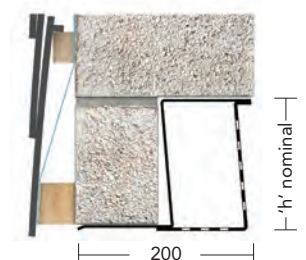

Please note other cavity widths and loading conditions are available.

Solid Wall - Box Lintels

Available for wall widths from 100mm to 140mm

WALL WIDTH

100mm - 140mm



HD BOX

Can be insulated as an optional extra. Perforated steel for plaster key. Lintels may be propped to facilitate speed of construction. See Lintel Installation on page 6.

Heavy Duty Load

HD BOX 100

Manufactured length 150mm increments	600- 1200	1350- 1800	1950- 2400	2550- 2700
Height 'h'	150	150	215	215
Thickness	2.5	2.5	2.5	2.5
Total UDL kN	50	45	50	40

For heavy duty loading conditions to support concrete floors and point loads. Used to support internal and external openings in 100mm wide walls.

Heavy Duty Load

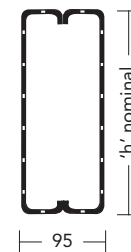

HD BOX 140

Manufactured length 150mm increments	600- 1200	1350- 1800	1950- 2400	2550- 2700
Height 'h'	150	150	215	215
Thickness	2.5	2.5	2.5	2.5
Total UDL kN	50	45	50	40

For heavy duty loading conditions to support concrete floors and point loads. Used to support internal and external openings in 150mm wide walls.

Heavy Duty Load

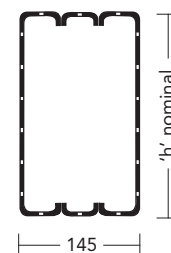

Please note other cavity widths and loading conditions are available.

Solid Wall - Box Lintels

Available for wall widths of 215mm

WALL WIDTH

215mm



HD BOX 200

Heavy Duty Load

HD BOX 200

This drawing illustrates how a BOX 200 Lintel can be used to support a 215mm leaf of solid stonework on the outer face of a traditional cavity wall.

The three dimensional image also illustrates how a DPC/Cavity Tray should be installed with this detail.

Cavity insulation omitted for clarity.

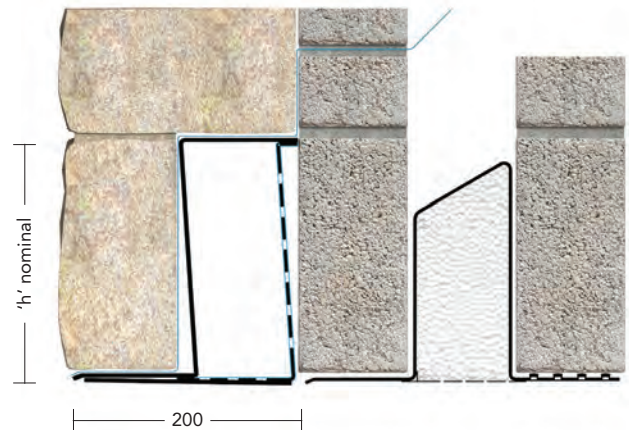

HD Box 200 Lintel shown with optional feature plate.

HD BOX 200				
Manufactured length 150mm increments	600- 1200	1350- 1800	1950- 2400	2550- 2700
Height 'h'	150	150	215	215
Thickness	2.5	2.5	2.5	2.5
Total UDL kN	40	35	45	40

The flange of the HD BOX 200 is designed to support a nominal masonry load only up to a maximum of 3kN per metre run. Used to support openings in 215mm wide walls.

DAMP PROOFING

Provide a damp proof course over all lintels used in an external cavity wall. For more guidance please see our on-line brochures or contact our technical team.

Heavy Duty Load

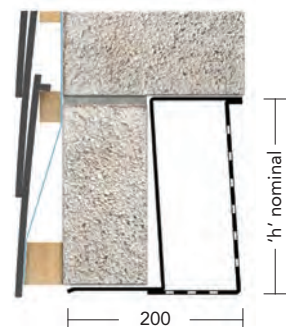

Please note other cavity widths and loading conditions are available.

**100 -215mm
WALL DEPTH**

Solid Wall Lintels



Standard Load

INT 100

Overall Length (mm)	900	1050	1100	1200
Maximum Span	700	850	900	1000
Total UDL kN	7	7	7	7



Specify INT 64 for 75mm solid wall.

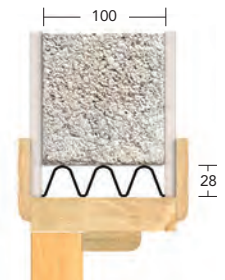

When using INT 100 normal building practice should be observed in that one course and the mortar allowed to cure for at least 24 hours before additional loads are applied. Not suitable for floor loads.

L9/SW 100

Manufactured length 150mm increments	600-1200	1350-1650	1800-2100	2250-2700
Height 'h'	55	86	86	113
Thickness Inner	2.5	2.5	2.9	3.2
Total UDL kN	6	8	8	10



Suitable for 100 - 150mm solid walls.

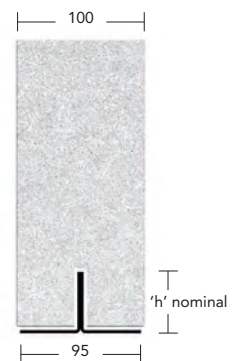

To achieve loading figures lintel must be built in as shown, blockwork must be tracked to accommodate upstand of lintel.

L9

Manufactured length 150mm increments	600-1500	1650-1800	1950-2700
Height 'h'	55	55	100
Thickness	2.5	3.0	3.0
Total UDL kN	6	6	10



Suitable for 215mm solid walls.

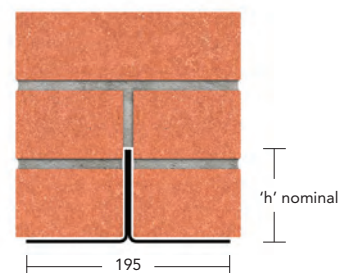

To achieve loading figures lintel must be built in as shown. Lintels may be propped to facilitate speed of construction. See Lintel Installation on page 6.

Solid Wall Lintels

Available for wall widths of 215mm

WALL WIDTH

215mm



I BEAM

To achieve loading figures lintel must be built in as shown. Lintels may be propped to facilitate speed of construction. See Lintel Installation on page 6.

DAMP PROOFING

Provide a damp proof course over all lintels. For more guidance please see our on-line brochures or contact our technical team.

Heavy to Extreme Loads

I BEAM (2C)		
Manufactured length 150mm increments	600-2100	2250-3000
Height 'h'	152	152
Thickness	2.5	2.9
Total UDL kN	30	30

Suitable for 215mm solid walls.

Heavy Duty Load

I BEAM (3C)					
Manufactured length 150mm increments	600-1800	1950-2100	2250-3000	3150-4050	4200-4800
Height 'h'	227	227	227	227	227
Thickness	2.5	2.5	2.9	3.2	3.2
Total UDL kN	45	40	40	40	35

Suitable for 215mm solid walls.

Extra Heavy Duty Load

XHD I BEAM						
Manufactured length 150mm increments	600-4800	5200	5400	5800	6200	6600
Height 'h'	230	230	230	230	230	230
End Bearing	200	200	200	200	200	200
Total UDL kN	86	75	70	65	60	55

Suitable for 215mm solid walls.

Extreme Duty

EXTENDED RANGE

- ROLLER SHUTTER LINTEL • UNIVERSAL ARCH • FEATURE PLATE LINTEL
- CANT BRICK LINTEL • STEPPED LINTEL • WEEP VENTS & STOP ENDS

ROLLER SHUTTER LINTEL

IG's Roller Shutter Lintel (L1/RSL) is a unique and innovative lintel solution designed to incorporate a security shutter system with a structural lintel. Integrated into the fabric of the building IG's roller shutter lintel ensures unobtrusive and enhanced aesthetics with increased security.

The lintel design can cater for traditional, timber frame and off site modular construction. Popular applications include schools and colleges, health and welfare facilities, community and sport centres, commercial and prestige residential developments.

Upon request IG can supply CAD details of the specially developed roller shutter and can provide an extensive client support service.

- Fully insulated box around roller shutter
- Removable panel allows access to roller shutter for maintenance

When the shutter is in the raised position, the window or door opening looks no different from any other structural opening. In the lowered position, the system gives a secure barrier against intruder and vandalism attack.

Custom made designs such as those for curved and arched windows are also available.

Please note that IG supplies the Roller Shutter Lintel only and not the cavity closer guides or shutter.



Dimension requirements:

a = mm

b = mm

c = mm

h = mm

Lintel length = mm

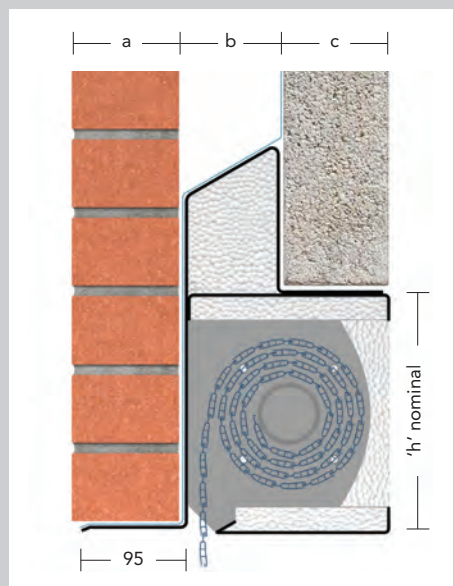

Extended Range



UNIVERSAL ARCH

When low rise arches are required in brickwork above openings, the IG Universal Arch provides the ideal former for the bricklayer. Vacuum-formed from white pigmented impact resistant polythene.

Suitable for use in cavity walls and with timber frame construction, the unit is designed to sit on any steel lintel with an outer flange of 90mm to 95mm.

FEATURE PLATE LINTEL

A feature plate can be supplied on all lintel profiles to suit 50-165mm wide cavities.

Example specification:
L1/S 100 (FP)

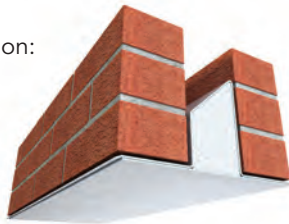

CANT BRICK LINTEL

The Cant brick Lintel can be supplied to suit all Lintel profiles for 50-165mm wide cavities.

Example specification:
L1/S 100 (CBA=45mm)

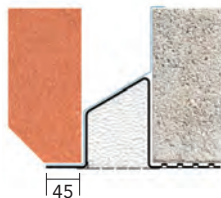

STEPPED LINTEL

All cavity lintels in the IG range can be stepped to suit your requirements.

Example specification: L1/ST 100 (20mm step)

Standard step = 20mm
Can be stepped to suit.

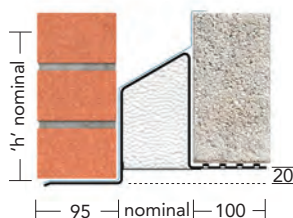

UNIVERSAL ARCH SELECTOR

OPENING SIZES	NOMINAL ARCH SPAN	ARCH RISE	IG REFERENCE
450-500	475	75	IGAR 475
600-650	625	75	IGAR 625
650-700	675	75	IGAR 675
700-750	725	75	IGAR 725
800-850	825	75	IGAR 825
900-950	925	75	IGAR 925
1000-1050	1025	75	IGAR 1025
1100-1150	1125	75	IGAR 1125
1200-1250	1225	75	IGAR 1225
1300-1350	1325	75	IGAR 1325
1450-1500	1475	75	IGAR 1475
1500-1550	1525	75	IGAR 1525
1600-1650	1625	75	IGAR 1625
1650-1700	1675	75	IGAR 1675
1750-1800	1775	75	IGAR 1775
1900-1950	1925	150	IGAR 1925
1950-2000	1975	150	IGAR 1975
2100-2150	2125	150	IGAR 2125
2200-2250	2225	150	IGAR 2225
2300-2350	2325	150	IGAR 2325
2400-2450	2425	150	IGAR 2425
2550-2600	2575	150	IGAR 2575
2700-2750	2725	150	IGAR 2725

Extended Range

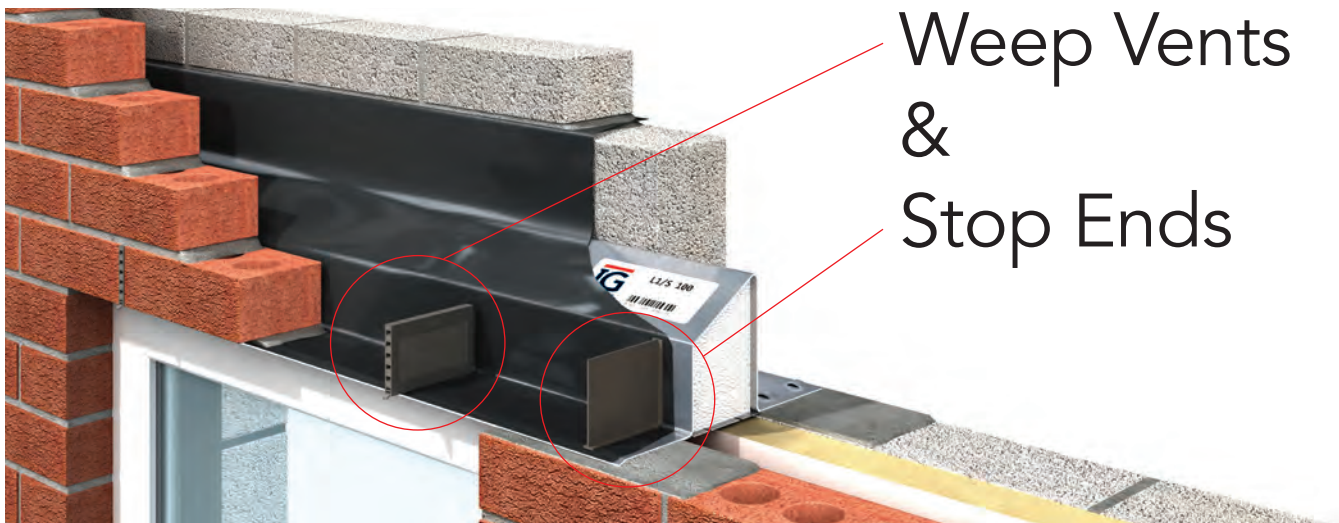

Weep Vents & Stop Ends

Weep Vents



Weep Vents create weep holes which are required over lintels to discharge collected water that may form at the window/door head. Each vent sits in the masonry perp end.

IG Weep Vents are positioned within the perp joints between masonry. Their function is two-fold:

- 1 They act as a weep to discharge water from DPCs, cavity trays and lintels.
- 2 They also act as ventilators to encourage the cavity to breathe.

IG Weep Vents also satisfy UK NHBC and Building Regulation requirements.

SIZES

49mm x 87mm x 9mm.
Free airflow approximately 300mm per unit.

Stop Ends

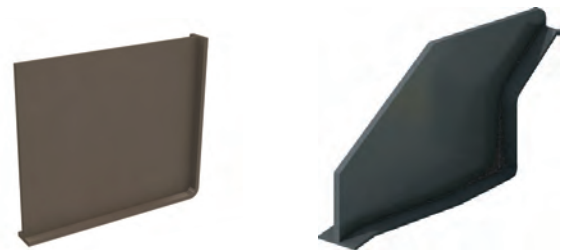

Standard Stop End
Specify KZ Stop

Hi-therm+ Stop End
Specify KZ Hi-therm Stop

A Stop End is required at each end of a lintel to prevent moisture cascading over the ends into the cavity and onto the inside wall. The use of Stop Ends quickly and economically introduces a lintel feature which removes the dangers that could occur with volumes of water being directed into the cavity.

STOP END SOLUTION

IG Stop Ends are available in two standard sizes. Stop Ends can be incorporated into the moulded base of the lintel by a butyl anchoring strip enabling the Stop End to be secured towards the end of the lintels in the most appropriate position to suit the masonry perp joint. When fitted discharge from lintels is directed through brickwork weeps.

WHY STOP ENDS ARE USED?

The Building Research Establishment defect action sheet (DAS98) states "If Stop Ends are not used on cavity trays or lintels acting as cavity trays, rain water discharge particularly in cavity filled walls, may wet the inner leaf, producing dampness of internal walls."

STAINLESS STEEL LINTELS

FULL RANGE OF STAINLESS STEEL LINTELS ALSO AVAILABLE

The use of Stainless Steel is ideal when the life expectancy and maintenance programme of a building are key design considerations, for example in specialist laboratory or medical applications, hospitals, residential care homes, schools, prisons and institutional buildings. Stainless steel is suitable in these developments because of its outstanding anti-corrosion properties.

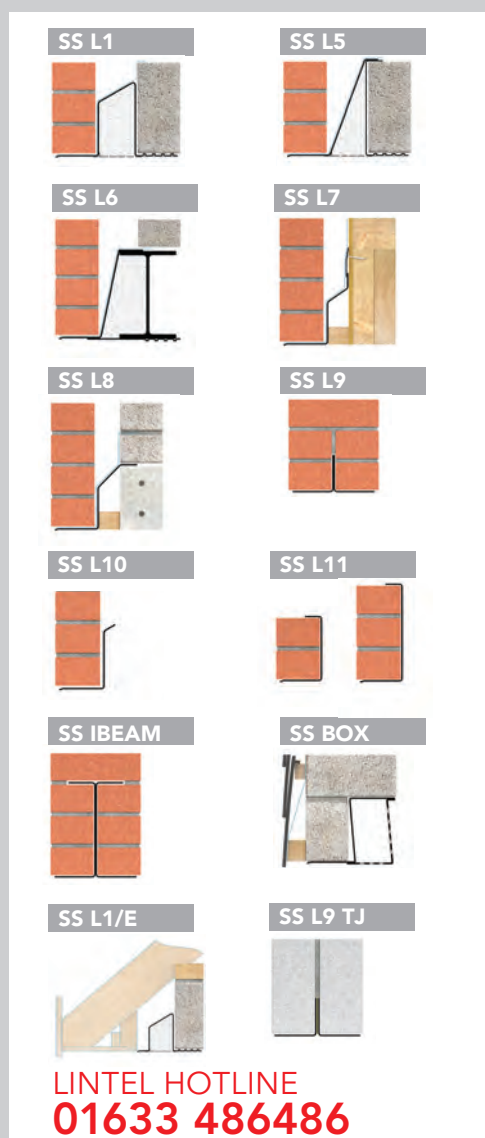

PRODUCT INFORMATION

- All IG Stainless Steel Lintels are manufactured from Austenitic Stainless Steel, grade 304 2b to BS EN 10088- Part 2 Astm 240 (European Grade 1.4307).
- Upon request, other grades of stainless steel lintels are available.
- All IG loading tables apply to both Stainless Steel and Galvanised Steel lintels, subject to lintel width availability.
- All IG Stainless Steel lintels are made to order, specific to each application.
- All standard stainless steel lintels from IG are BBA approved.
- Special lintels are also available in Stainless Steel, made to order.

'British Standard Code of Practice for the use of masonry - pt 3; Materials and Components' recommends the use of Stainless Steel Lintels in buildings that are subjected to aggressive environmental conditions and buildings exceeding three storeys.

There is also a requirement for NHBC registered projects to use Stainless Steel Lintels in coastal locations, namely, within 500m of the shoreline.



SPECIAL LINTELS

CUSTOM MADE LINTEL SELECTION

Special lintels provide the client and architect with a means to personalise a building's design. For over 50 years IG have been manufacturing special lintels for the construction industry, helping to make buildings that little bit more special.

CUSTOM MADE SPECIAL LINTELS

An IG special lintel is ideal when something bespoke is required, whether to provide a unique building feature, or to carry an unusual loading condition. With a dedicated team of engineers, IG assesses the loading conditions and then designs the structural lintels, tailor made to the requirements and constraints of the individual project, in the most cost effective manner.

From parabolic, segmental, gothic and full arch lintels, bows, bays, corners and sun-lounge lintels the sky is the limit with IG's Special Lintel range.



Square Bay Lintel

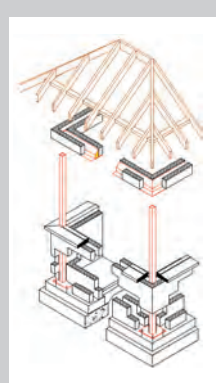
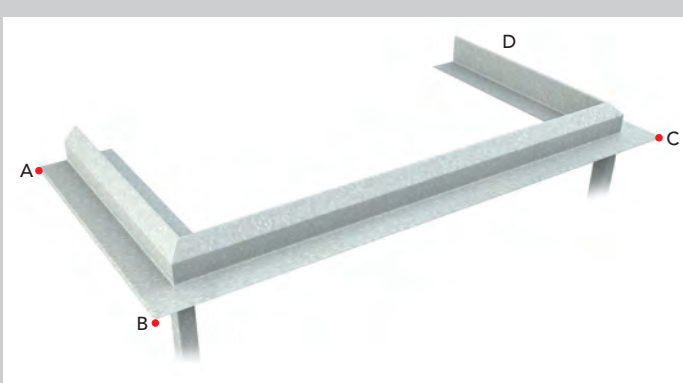

DIMENSIONS REQUIRED	
LINTEL DIMENSIONS	
A to B =	mm
B to C =	mm
C to D =	mm
PLASTER KEY REQUIRED (Please Tick)	
INSIDE ONLY	<input type="checkbox"/>
BOTH SIDES	<input type="checkbox"/>
NONE	<input type="checkbox"/>
WALL CONSTRUCTION	
OUTER LEAF	mm
CAVITY WIDTH	mm
INNER LEAF	mm
SUPPORT POST	
HEIGHT	mm
<p>IMPORTANT NOTE: Do not allow for bearing, this will be added at design approval stage. Very accurate measurements required.</p>	

Full Arch Lintel

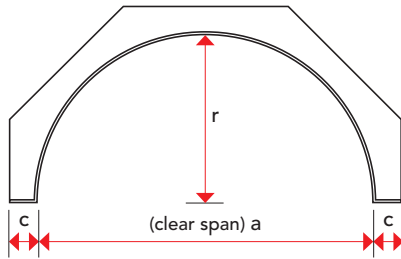

DIMENSIONS REQUIRED	
LINTEL DIMENSIONS	
CLEAR SPAN (a)	mm
RADIUS (r)	mm
END BEARING (c)	mm
PLASTER KEY REQUIRED (Please Tick)	
INSIDE ONLY	<input type="checkbox"/>
BOTH SIDES	<input type="checkbox"/>
NONE	<input type="checkbox"/>
WALL CONSTRUCTION	
OUTER LEAF	mm
CAVITY WIDTH	mm
INNER LEAF	mm

IMPORTANT NOTE:
Do not allow for bearing, this will be added at design approval stage. Very accurate measurements required.

Segmental Arch Lintel

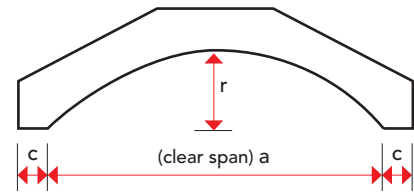
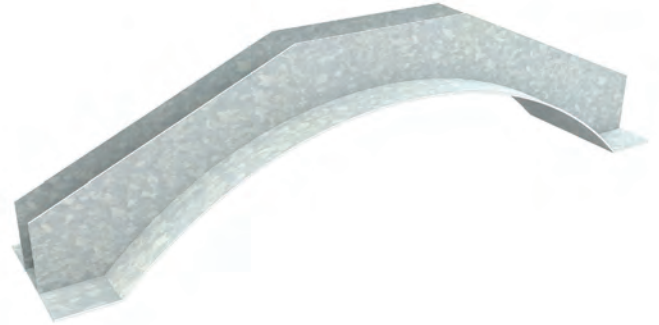

DIMENSIONS REQUIRED	
LINTEL DIMENSIONS	
CLEAR SPAN (a)	mm
RISE (r)	mm
END BEARING (c)	mm
PLASTER KEY REQUIRED (Please Tick)	
INSIDE ONLY	<input type="checkbox"/>
BOTH SIDES	<input type="checkbox"/>
NONE	<input type="checkbox"/>
WALL CONSTRUCTION	
OUTER LEAF	mm
CAVITY WIDTH	mm
INNER LEAF	mm

IMPORTANT NOTE:
Do not allow for bearing, this will be added at design approval stage. Very accurate measurements required.



Parabolic Arch Lintel

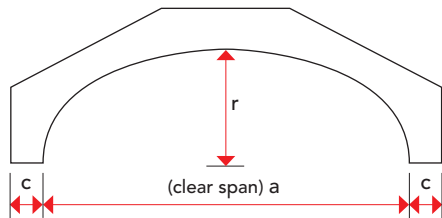
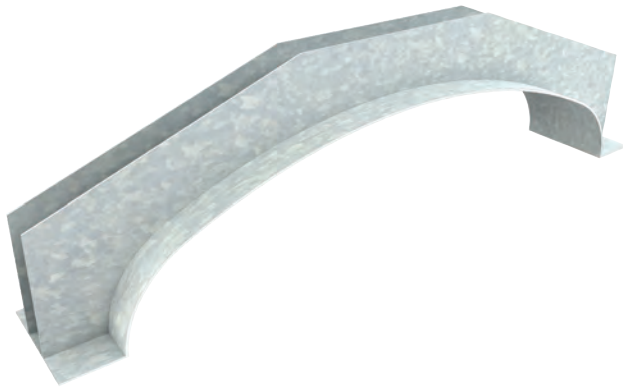

DIMENSIONS REQUIRED	
LINTEL DIMENSIONS	
CLEAR SPAN (a)	mm
RISE (r)	mm
END BEARING (c)	mm
PLASTER KEY REQUIRED (Please Tick)	
INSIDE ONLY	<input type="checkbox"/>
BOTH SIDES	<input type="checkbox"/>
NONE	<input type="checkbox"/>
WALL CONSTRUCTION	
OUTER LEAF	mm
CAVITY WIDTH	mm
INNER LEAF	mm

IMPORTANT NOTE:
Do not allow for bearing, this will be added at design approval stage. Very accurate measurements required.

Venetian Arch Lintel

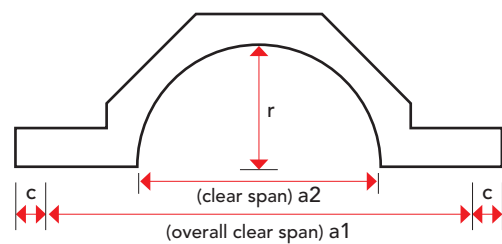

DIMENSIONS REQUIRED	
LINTEL DIMENSIONS	
OVERALL CLEAR SPAN (a1)	mm
CLEAR SPAN (a2)	mm
RISE (r)	mm
END BEARING (c)	mm
PLASTER KEY REQUIRED (Please Tick)	
INSIDE ONLY	<input type="checkbox"/>
BOTH SIDES	<input type="checkbox"/>
NONE	<input type="checkbox"/>
SUPPORT POSTS (if required)	
HEIGHT	mm
WALL CONSTRUCTION	
OUTER LEAF	mm
CAVITY WIDTH	mm
INNER LEAF	mm
ARCH TYPE PLEASE TICK:	
<input type="checkbox"/> Full	<input type="checkbox"/> Segmental
<input type="checkbox"/> Parabolic	<input type="checkbox"/> Apex
<input type="checkbox"/> Gothic	

IMPORTANT NOTE:
Do not allow for bearing, this will be added at design approval stage. Very accurate measurements required.



Apex & Half Apex Lintel



Apex Lintel

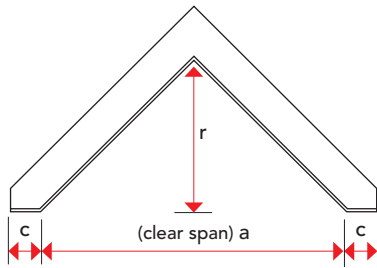

Half Apex Lintel

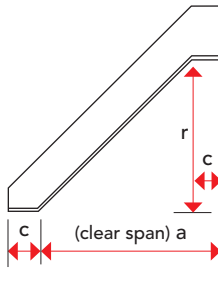

DIMENSIONS REQUIRED	
LINTEL DIMENSIONS	
CLEAR SPAN (a)	mm
RISE (r)	mm
END BEARING (c)	mm
PLASTER KEY REQUIRED (Please Tick)	
INSIDE ONLY	<input type="checkbox"/>
BOTH SIDES	<input type="checkbox"/>
NONE	<input type="checkbox"/>
WALL CONSTRUCTION	
OUTER LEAF	mm
CAVITY WIDTH	mm
INNER LEAF	mm

IMPORTANT NOTE:
Do not allow for bearing, this will be added at design approval stage. Very accurate measurements required.

Gothic Arch Lintel

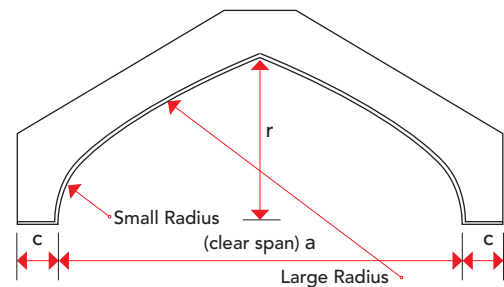
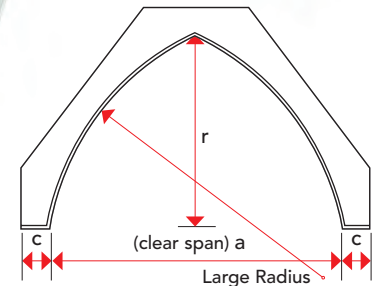

DIMENSIONS REQUIRED			
LINTEL DIMENSIONS		PLASTER KEY REQUIRED (Please Tick)	
CLEAR SPAN (a)	mm	INSIDE ONLY	<input type="checkbox"/>
RISE (r)	mm	BOTH SIDES	<input type="checkbox"/>
END BEARING (c)	mm	NONE	<input type="checkbox"/>
RADIUS TYPE (Please Tick)		WALL CONSTRUCTION	
SINGLE	<input type="checkbox"/>	OUTER LEAF	mm
DOUBLE	<input type="checkbox"/>	CAVITY WIDTH	mm
SINGLE RADIUS (if known)		INNER LEAF	mm
RADIUS		IMPORTANT NOTE: Very accurate measurements required.	
DOUBLE RADIUS (if known)			
LARGE RADIUS	<input type="checkbox"/>		
SMALL RADIUS		<input type="checkbox"/>	



Corner Lintel

STANDARD DUTY CORNER LINTEL



The IG Corner Lintel is supplied as a 'one piece' fully mitred and welded structural unit for easy installation.

HEAVY DUTY CORNER LINTEL

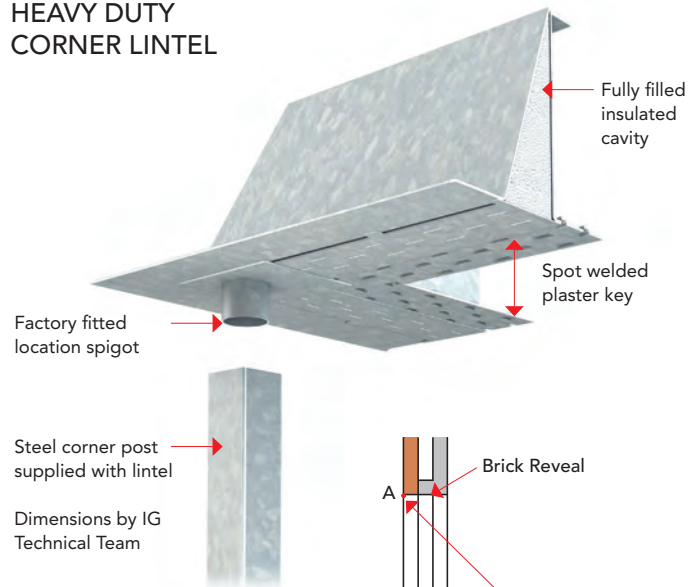

Factory fitted location spigot

Steel corner post supplied with lintel

Dimensions by IG Technical Team

SECTION THROUGH CORNER AND POST SUPPORTED ON SUBSTRUCTURE

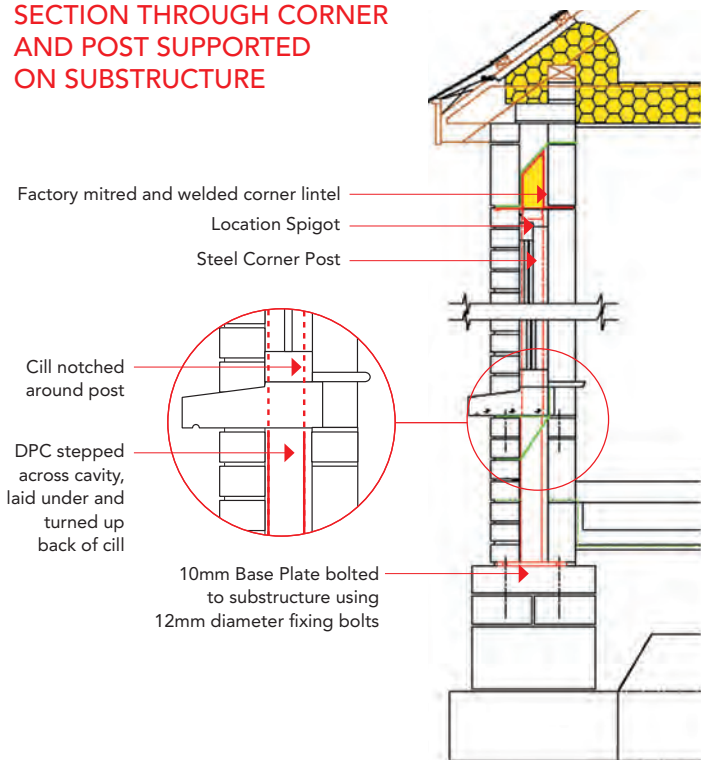

IMPORTANT NOTE:
Do not allow for bearing, this will be added at design approval stage. Very accurate measurements required.

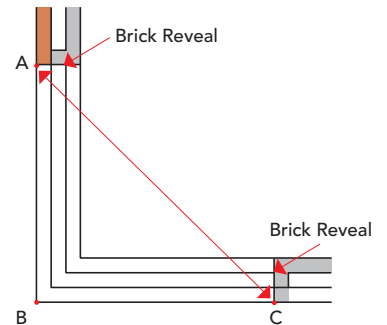

DIMENSIONS REQUIRED	
MASONRY OPENING DIMENSIONS	
A to B =	mm
B to C =	mm
A to C =	mm
PLASTER KEY REQUIRED (Please Tick)	
INSIDE ONLY	<input type="checkbox"/>
BOTH SIDES	<input type="checkbox"/>
NONE	<input type="checkbox"/>
WALL CONSTRUCTION	
OUTER LEAF	mm
CAVITY WIDTH	mm
INNER LEAF	mm
SUPPORT POST	
HEIGHT	mm



Bow Lintel

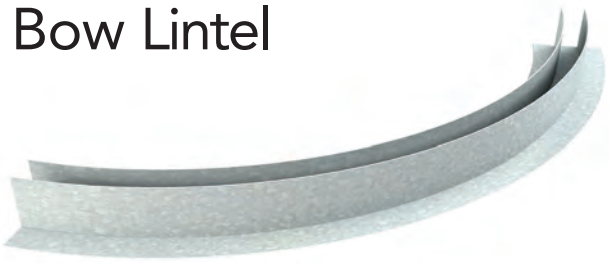

Bow Lintel with Projecting Reveals

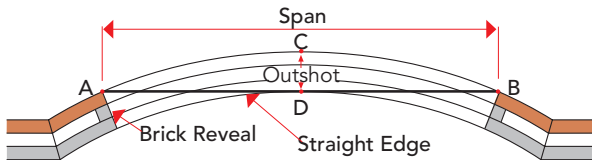

Bow Lintel with Non Projecting Reveals

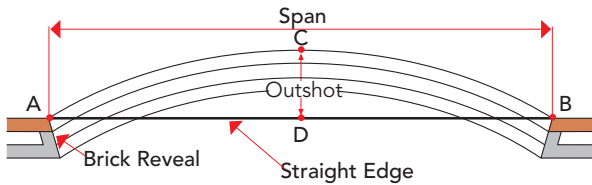

DIMENSIONS REQUIRED	
MASONRY OPENING DIMENSIONS	
A to B =	mm
C to D =	mm
REVEALS (Please Tick)	
PROJECTING	<input type="checkbox"/>
NON-PROJECTING	<input type="checkbox"/>
PLASTER KEY REQUIRED (Please Tick)	
INSIDE ONLY	<input type="checkbox"/>
BOTH SIDES	<input type="checkbox"/>
NONE	<input type="checkbox"/>
WALL CONSTRUCTION	
OUTER LEAF	mm
CAVITY WIDTH	mm
INNER LEAF	mm
SUPPORT POST	
HEIGHT	mm

IMPORTANT NOTE:
Do not allow for bearing, this will be added at manufacturing stage. Very accurate measurements required.

Splayed Bay Lintel



Splayed Bay with Projecting Reveals

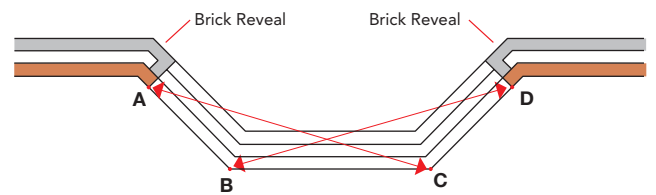

Splayed Bay with Non Projecting Reveals

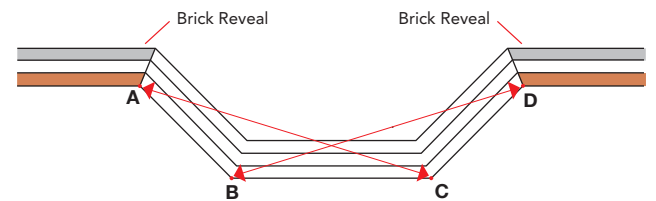

DIMENSIONS REQUIRED			
MASONRY OPENING DIMENSIONS		PLASTER KEY REQUIRED (Please Tick)	
A to B =	mm	INSIDE ONLY	<input type="checkbox"/>
B to C =	mm	BOTH SIDES	<input type="checkbox"/>
C to D =	mm	NONE	<input type="checkbox"/>
A to D =	mm	WALL CONSTRUCTION	
A to C =	mm	OUTER LEAF	mm
B to D =	mm	CAVITY WIDTH	mm
REVEALS (Please Tick)		INNER LEAF	mm
PROJECTING	<input type="checkbox"/>	IMPORTANT NOTE: Do not allow for bearing, this will be added at manufacturing stage. Very accurate measurements required.	
NON-PROJECTING	<input type="checkbox"/>		
SUPPORT POST			
HEIGHT	mm		



SUN LOUNGE LINTELS

CUSTOM MADE SUN LOUNGE LINTEL SELECTION

It is universally recognised amongst home owners and house builders that a sun lounge is a more practical, user friendly room than a conservatory. Furthermore, a sun lounge floor area can be included in the overall measurement of your house size, adding much more value to your home.

WHAT DOES A SUN LOUNGE OFFER YOU?

A Sun Lounge Lintel is an easy way to add space at low cost when building a new house, or extending a property. An extra room rather than an add-on, a Sun Lounge is comfortable all year round while allowing you to watch the seasons come and go in comfort.

A Sun Lounge will blend with the existing appearance of your home. It is easy to construct, using materials similar to your house. Also, it adds genuine floor space, it is structurally sound and it adds value immediately.



WHAT DOES IG OFFER?

The construction of a Sun Lounge has been simplified by the introduction of an IG Lintel. It is a one piece unit which eliminates the need for local engineering, allows architects to design the Sun Lounge to suit the property, and will keep the cost sensible.

The IG Sun Lounge Lintel is designed and delivered ready for erection.

SUN LOUNGE OR CONSERVATORY?

A Sun Lounge is more competitively priced than a conservatory, is more visually appealing, is easier to clean, and is not a bolt on 'extra'.

- Much better heat retention in winter
- Protection from the summer sun
- Reduced noise compared to a conservatory roof



Standard Sun Lounge Lintel

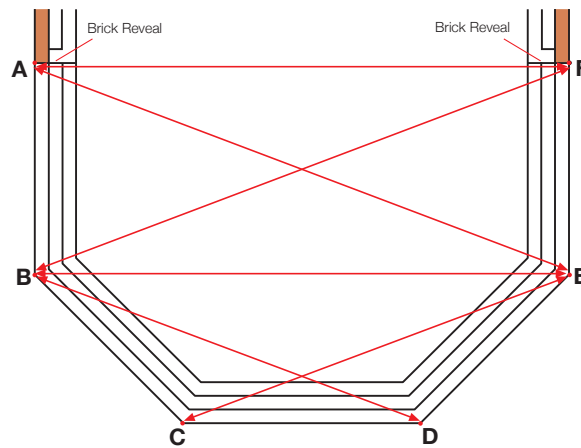
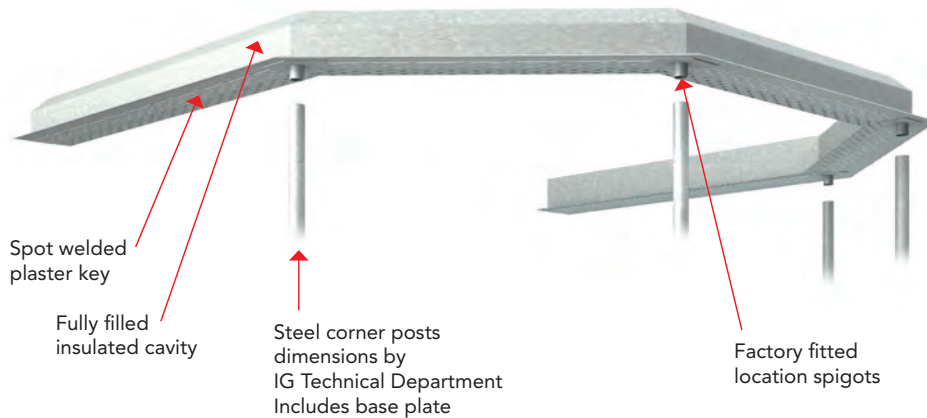

DIMENSIONS REQUIRED	
MASONRY OPENING DIMENSIONS	
A to B =	mm
B to C =	mm
C to D =	mm
D to E =	mm
E to F =	mm
A to F =	mm
A to E =	mm
B to F =	mm
B to E =	mm
C to E =	mm
B to D =	mm
PLASTER KEY REQUIRED (Please Tick)	
INSIDE ONLY	<input type="checkbox"/>
BOTH SIDES	<input type="checkbox"/>
NONE	<input type="checkbox"/>
WALL CONSTRUCTION	
OUTER LEAF	mm
CAVITY WIDTH	mm
INNER LEAF	mm
SUPPORT POST	
HEIGHT	mm

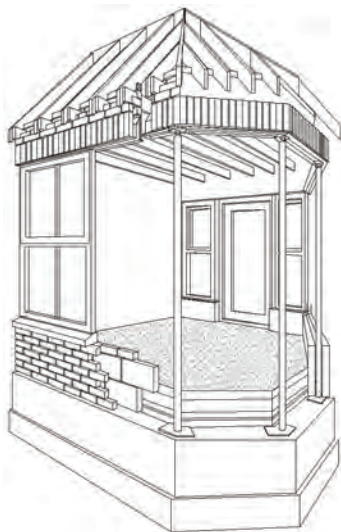

STANDARD SIZES

SUN LOUNGE	INTERNAL WIDTH	INTERNAL LENGTH
Type A	3 metres	3 metres
Type B	3 metres	3.6 metres
Type C	3.6 metres	3.6 metres
Type D	3.6 metres	4 metres
Type E	4 metres	4 metres
Type F	4 metres	4.6 metres

MAKING IT EASY

The sun lounge lintel can be supplied in any size to suit your requirements. FASTRACK AutoCAD files can be downloaded from our website at: www.iglintels.com/autocad



Apex Sun Lounge Lintel

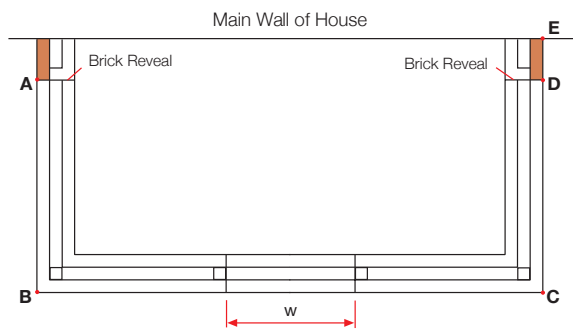

DIMENSIONS REQUIRED	
MASONRY OPENING DIMENSIONS	
A to B =	mm
B to C =	mm
C to D =	mm
C to E =	mm
OTHER DIMENSIONS	
Height from top of substructure to underside of lintels (H)	mm
External frame width of patio doors if applicable (W)	mm
Roof pitch	mm
IMPORTANT NOTE: Do not allow for bearing, this will be added at manufacturing stage. Very accurate measurements required.	

Venetian Sun Lounge Lintel

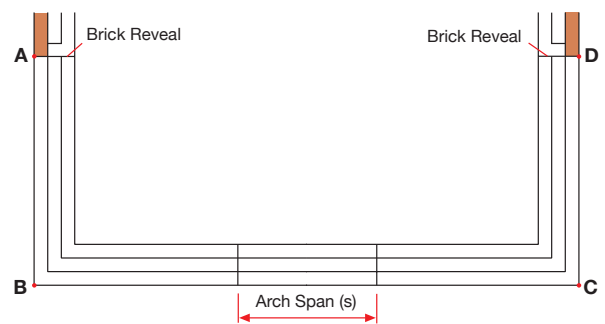

DIMENSIONS REQUIRED			
MASONRY OPENING DIMENSIONS		PLASTER KEY REQUIRED (Please Tick)	
A to B =	mm	INSIDE ONLY	<input type="checkbox"/>
B to C =	mm	BOTH SIDES	<input type="checkbox"/>
C to D =	mm	NONE	<input type="checkbox"/>
ARCH DIMENSIONS		WALL CONSTRUCTION	
ARCH SPAN (s) =	mm	OUTER LEAF	mm
RISE (r) =	mm	CAVITY WIDTH	mm
SUPPORT POST		INNER LEAF	mm
HEIGHT	mm		
SUN LOUNGE ARCH TYPE			
DESCRIPTION		IMPORTANT NOTE: Do not allow for bearing, this will be added at manufacturing stage. Very accurate measurements required.	



Bow Sun Lounge Lintel

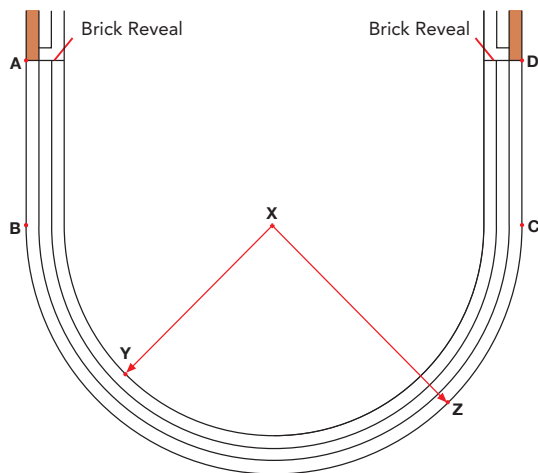
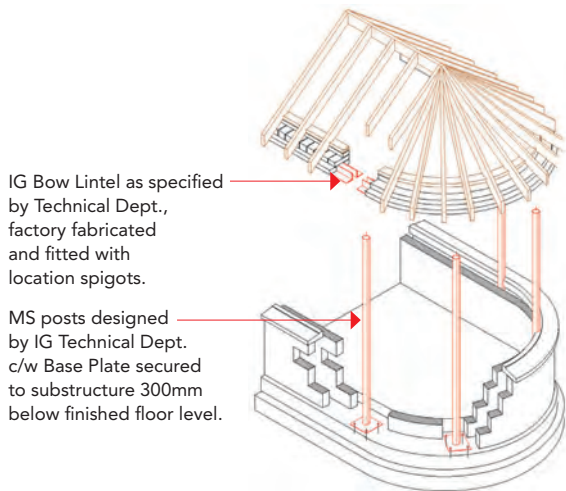

DIMENSIONS REQUIRED			
MASONRY OPENING DIMENSIONS		PLASTER KEY REQUIRED (Please Tick)	
A to B =	mm	INSIDE ONLY	
B to C =	mm	BOTH SIDES	
C to D =	mm	NONE	
X to Y =	mm	WALL CONSTRUCTION	
X to Z =	mm	OUTER LEAF	mm
SUPPORT POST		CAVITY WIDTH	mm
HEIGHT	mm	INNER LEAF	mm

IMPORTANT NOTE: Do not allow for bearing, this will be added at manufacturing stage. Very accurate measurements required.



Square Bay Sun Lounge Lintel

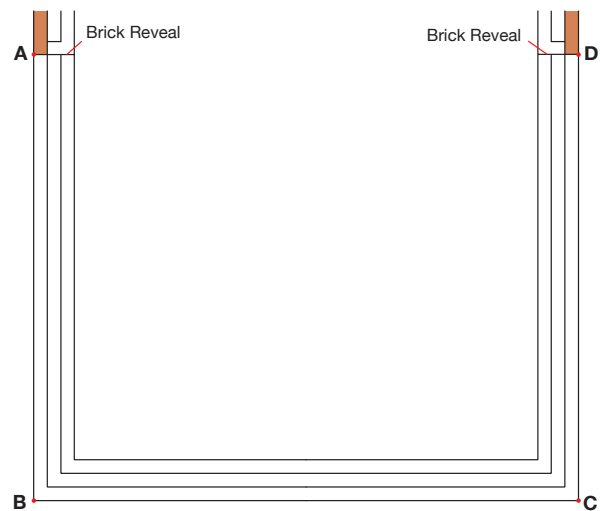
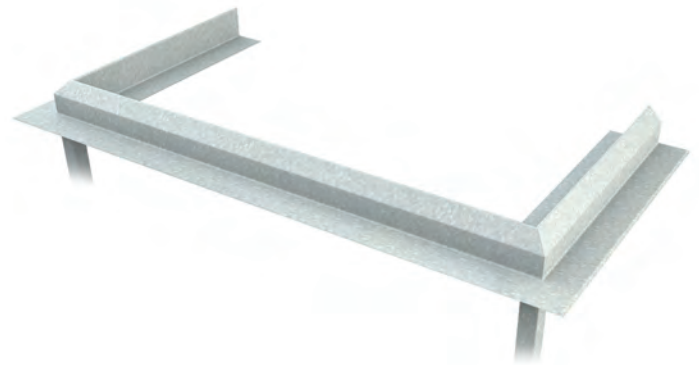

DIMENSIONS REQUIRED			
MASONRY OPENING DIMENSIONS		PLASTER KEY REQUIRED (Please Tick)	
A to B =	mm	INSIDE ONLY	
B to C =	mm	BOTH SIDES	
C to D =	mm	NONE	
SUPPORT POST		WALL CONSTRUCTION	
HEIGHT	mm	OUTER LEAF	mm
		CAVITY WIDTH	mm
		INNER LEAF	mm

IMPORTANT NOTE: Do not allow for bearing, this will be added at manufacturing stage. Very accurate measurements required.

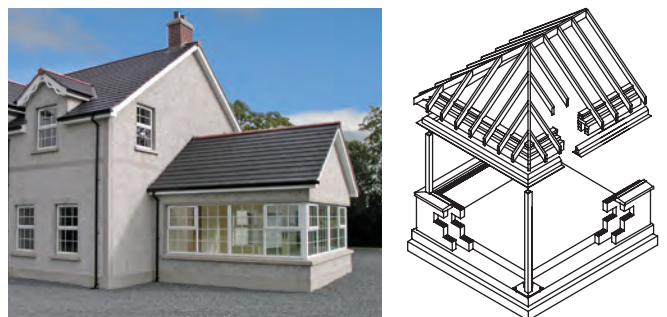

Standard Sun Lounge Construction Data

CONSTRUCTION DETAILS

Provide 150mm fibreglass quilt insulation between roof rafters and collar ties. Insulation to be carried over top of cavity wall and pushed into soffit box to prevent a cold bridge. Install Cullen G400 eaves ventilators to provide a continuous air path for roof space ventilation between roof and insulation and roof underlay at eaves equivalent to 10,000mm²/m with Cullen G1200 over fascia ventilator to provide ventilation to roof space equivalent 10,000mm²/m in accordance with Building Regs. Approved Document F and or BS 5250: 2011. Fixed in accordance with manufacturers instructions.

Provide stepped cavity tray across wall directly above Code No.4 flashing, where new roof abuts wall. Note all lead to be treated with patination oil. Rainwater goods fascia and soffit to match existing. RC cill with DPC @ rear, ends and under. Wall DPC located min. 150mm above ground level. 300mm solid blockwork footings.

250mm x 600mm concrete foundation. Form new opening from existing dwelling into Sun Lounge to client's requirements.

Provide vertical DPC where Sun Lounge window abuts existing wall. Where new wall abuts existing, new cavity to be continuous with existing cavity. Provide 35mm polystyrene insulation between MS post and against inner leaf where post is inside cavity, to prevent a cold bridge. All glazed panels to doors and side panels with glazing less than 1500mm above floor or ground level to be safety glass to BS6206: Class B and C.

Provide 300mm cavity wall construction with 60mm Rigid Polystyrene Insulation - Wall ties with insulation clips to be spaced 750mm horizontal and 450mm vertical CRS. Form new external steps @ doorway to comply with current Building Regs. Any new heating pipes to be insulated with an insulation of thickness of not less than the diameter of the pipe - insulation to BS 5422:2009.

Provide 100mm dia stormwater drain, laid to fall 1:60, drain pipe to be surrounded with 150mm pea gravel. All drain pipes to comply with BS 4660 - connected to existing system.

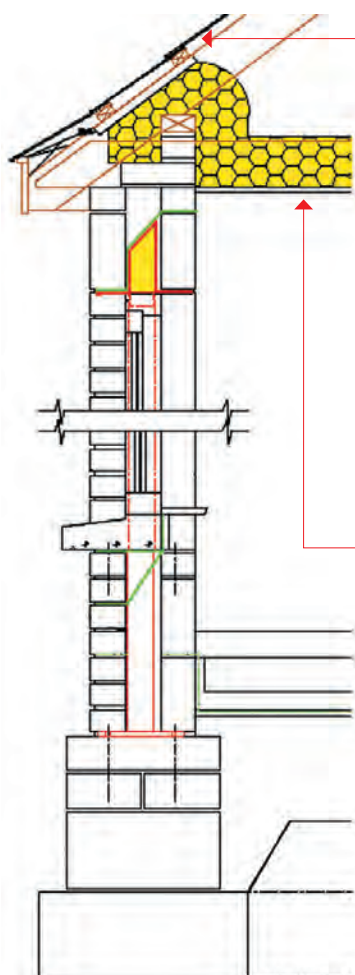

ROOF CONSTRUCTION:

Slates or tiles to match existing on 25x50mm battens on one layer sarking felt on 38x150mm rafters @ 400mm CRS with 38x50mm battens to U/S of rafters to maintain 50mm airgap within roof construction when incorporating 150mm fibre glass quilt insulation. 50x100mm Ridge Plate shot fixed to T/S ridge beam. 50x100mm Wall Plate securely strapped down to wall using 5x30mm galv ms straps by Cullen or equal @ 1200mm CRS. 100x25mm diagonal bracing positioned both sides of roof. 38x100mm collar ties @ 400mm CRS. 50x250mm hip rafters. TG and V redwood sheeting ceiling painted with Class 1 SSF varnish. All structural timber to be C16 or greater and must be stamped accordingly.

STRUCTURAL RIGIDITY:

- Roof Anchorage - First rafter and collar tie to be bolted to main wall at 450mm CRS using Rawl bolts or similar proprietary fixing.
- MS support posts and factory fitted Base Plate to be bolted down on top of solid footings built up to 300mm below finished floor level.
- Racking resistance provided using 9mm plywood secured to U/S of rafters and collar ties prior to any decorative finishes.
- Where a raised or vaulted ceiling is required an IG Ridge Beam Cradle must be used.

Ridge Beam Cradle

NOTE:

Where a Cathedral or Vaulted ceiling is required the IG Ridge Beam Cradle is supplied to support the roof structure and resist roof spread.

EXPLODED ISOMETRIC VIEW

FIXING DETAIL

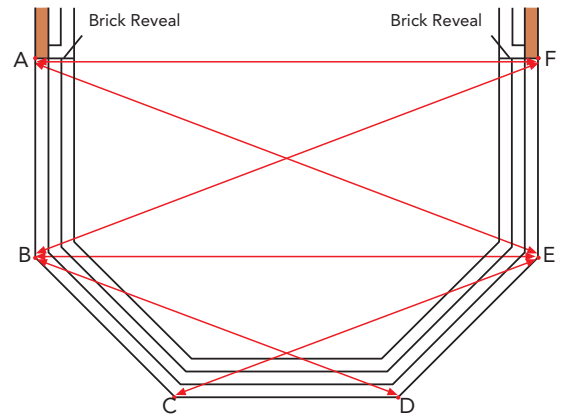
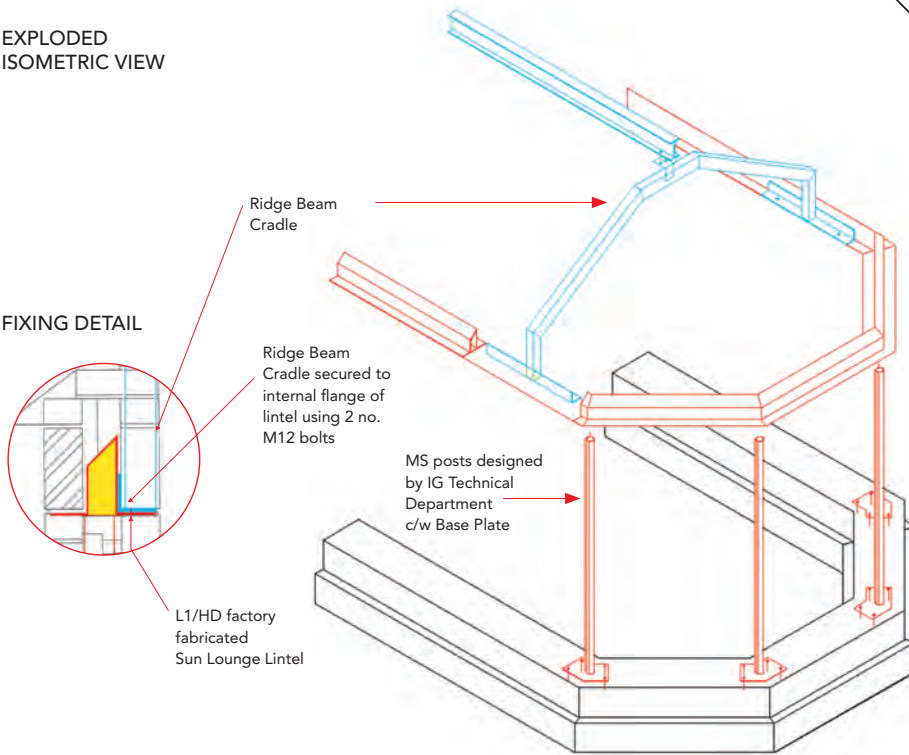

DIMENSIONS REQUIRED

MASONRY OPENING DIMENSIONS

A to B =	mm
B to C =	mm
C to D =	mm
D to E =	mm
E to F =	mm
A to F =	mm
A to E =	mm
B to F =	mm
B to E =	mm
C to E =	mm
B to D =	mm

PLASTER KEY REQUIRED (Please Tick)

INSIDE ONLY	
BOTH SIDES	
NONE	

WALL CONSTRUCTION

OUTER LEAF	mm
CAVITY WIDTH	mm
INNER LEAF	mm

SUPPORT POST

HEIGHT	mm
--------	----

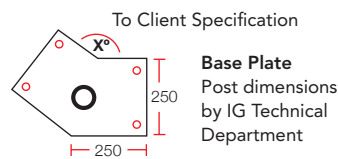



BRICK SLIP FEATURE LINTELS

CUSTOM MADE BRICK SLIP FEATURE LINTELS

IG provides a technically advanced solution for an extensive range for brick slip installations including arches, panels, soffits and architectural features.

Produced off site as a one piece prefabricated unit, the patented IG system ensures maximum performance thanks to the unique adhesion process.

IG's Brick Slip Feature Lintels can be installed quickly with minimum interruption to the contractor's schedule.

IG receives a consignment of the brick being used on site. This brick is then tailored to suit the client's design and fixed to IG's galvanized and powder-coated structural steel elements. The finished Brick Slip Feature Lintel joins seamlessly with the already constructed brickwork.

IG Brick Slip Feature Lintel Benefits

- Customised to your requirements
- Precision cut bricks
- Load bearing lintel
- Lightweight for fast build programmes
- Optional brick clad soffit
- Optional centre stone feature
- Optional Insulation



Patented Brick Slip System

“IG provides a totally bespoke service for even the most complex brick slip project.”

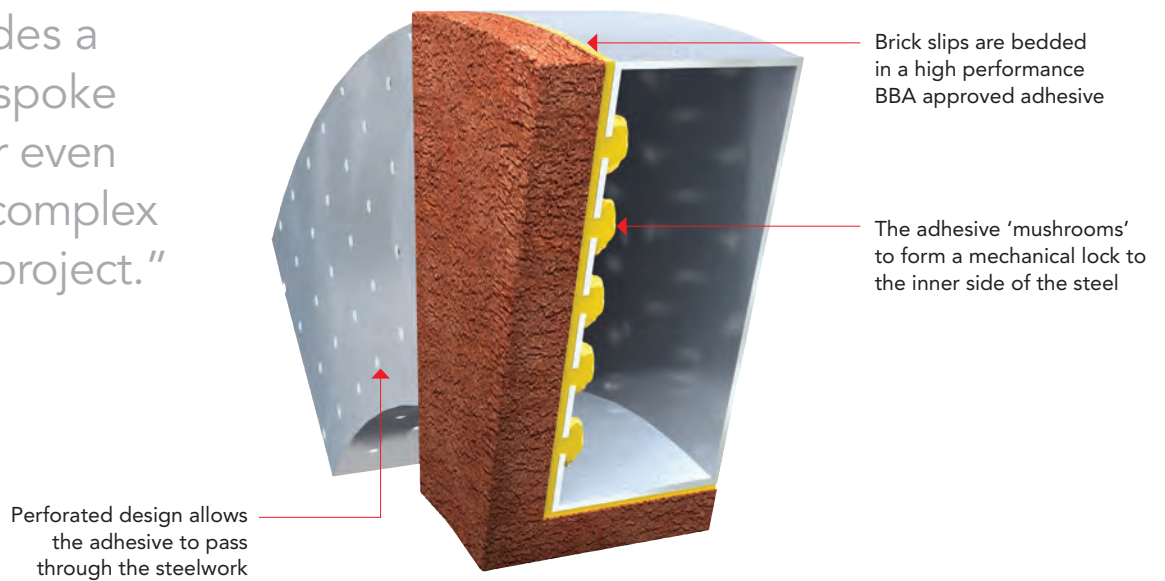

With thousands of installations completed over the past decade the system is a proven and reliable solution which provides maximum adhesion of the brick slips.

The patented design of the perforated steelwork interfaces with the adhesive allowing the adhesive to pass through and form a mushroom on the inside of the steel creating a physical lock.

Independent testing carried out by Lucideon has verified that in destructive testing there were no failures in the steel/adhesive interface.

BRICK ADHESIVE

IG uses only specialist high performance adhesives designed primarily for the decorative brick industry which have been extensively tested and are BBA approved

CONTROLLED CONDITIONS

IG Brick Slip Feature Lintels are produced off-site in a factory environment which ensures that the bonding process occurs in optimum controlled conditions free from wet weather, extreme temperature and excessive dust.

LUCIDEON BUILDING TECHNOLOGY

Test report Number SW238/02

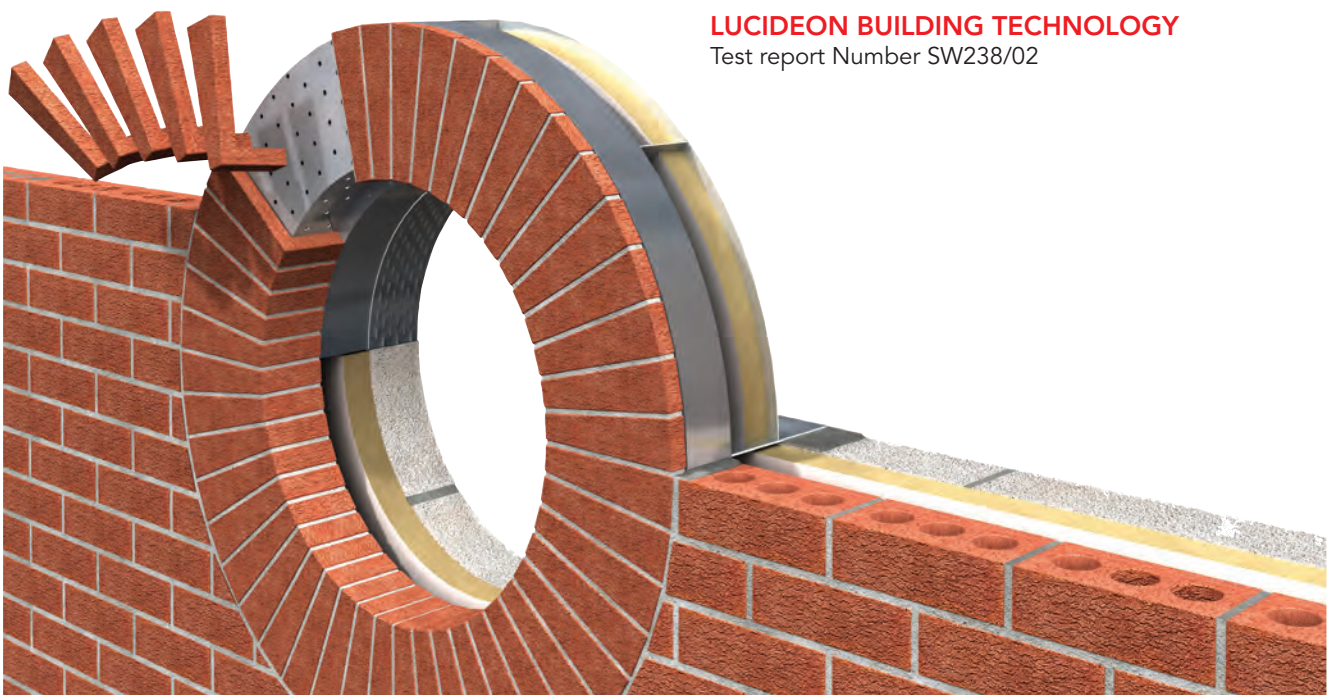

Brick Slip Arch Solutions

IG specialises in producing brick slip arch solutions for both domestic and commercial applications. Arches of up to 12m span have been produced therefore eliminating the brick cutting process on site.

IG's Segmental Arch Brick Slip Feature Lintel

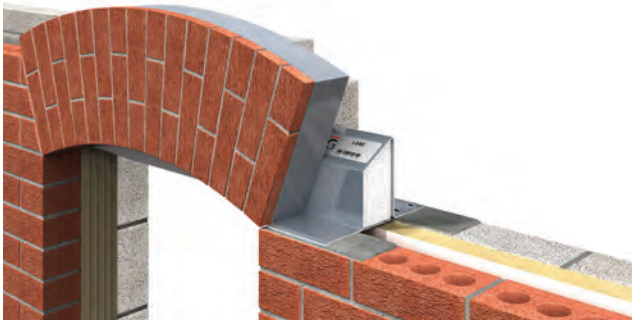

IG's Flat Arch Brick Slip Feature Lintel



IG's Gothic Arch Brick Slip Feature Lintel



IG's Parabolic Arch Brick Slip Feature Lintel



IG's Full Bullseye Arch Brick Slip Feature Lintel

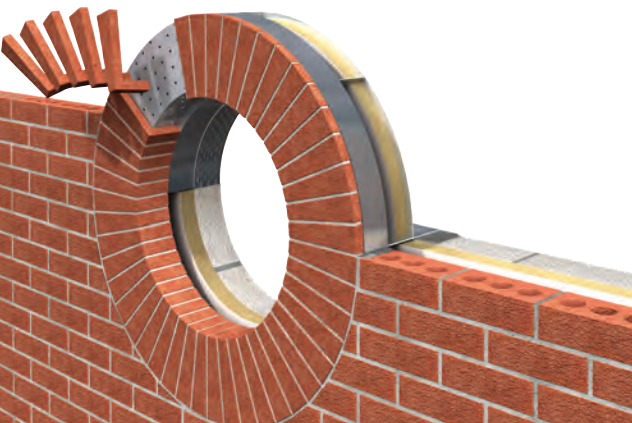

IG's Apex Arch Brick Slip Feature Lintel



Brick Slip Soffit Solutions

IG offers a range of brick slip soffit solutions with a bespoke design and technical service.

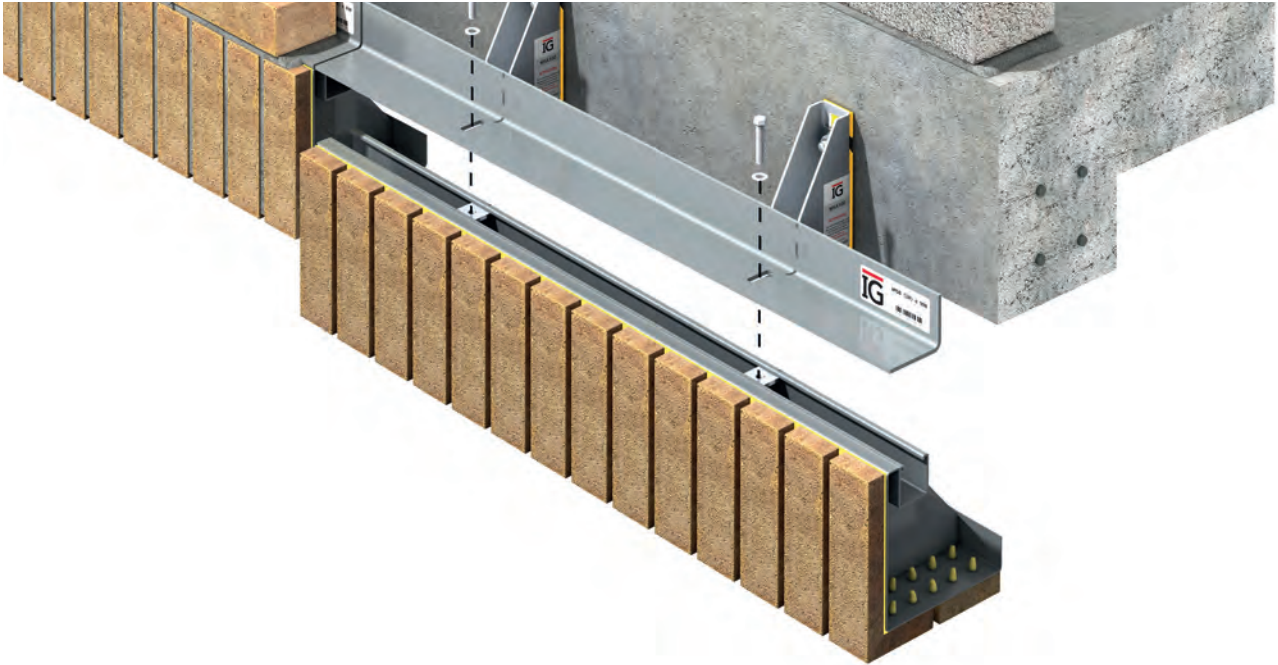

By combining our IG masonry support system with bespoke steel components we produce single and double sided soffit systems which are ideal for runs of any length.

This versatile approach can adapt to suit the particular building frame and in each case IG offers a highly practical solution onsite.

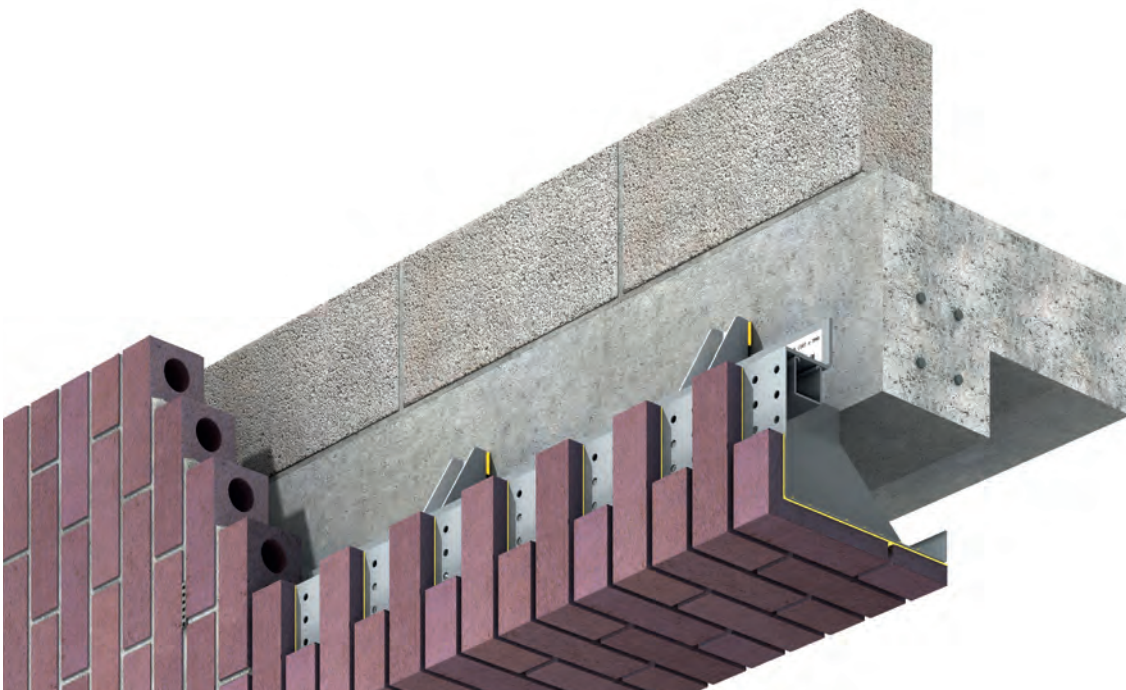

Brick Slip Panel Solutions

IG's bespoke components use a patented adhesion system and are delivered to site as a complete unit ready for installation and final pointing.



Step 1 The brick slip panel is positioned, fixed and built into the outer skin.



Step 2 The brick slips are pointed to ensure a seamless appearance.

Bespoke Brick Slip Solutions

IG designed and produced a totally bespoke solution for this complex brickwork project on new student accommodation at Liverpool University.

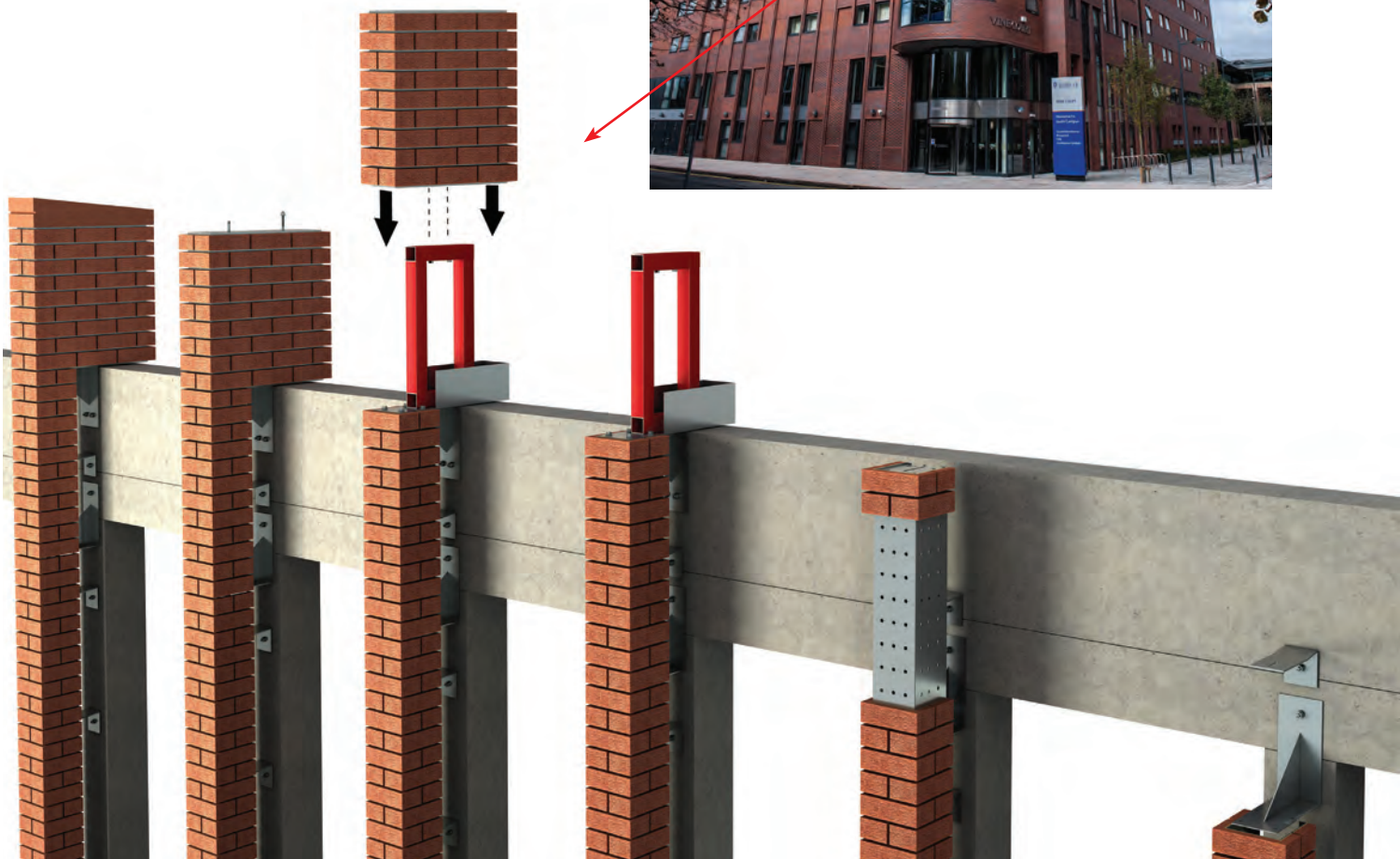

Featured Brick Slip Projects

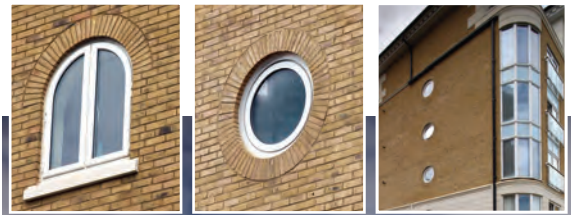

MASONRY SUPPORT

IG MASONRY SUPPORT SYSTEM

A range of systems suitable for supporting any outer leaf material: brickwork, fairface blockwork, rendered blockwork, cut and reconstituted stone. The systems can be fixed back to reinforced concrete cast-in channel and steel sections.

The IG Masonry Support System is an off the shelf product which mean the brackets and shelf are interchangeable, allowing greater flexibility for various loading scenarios.

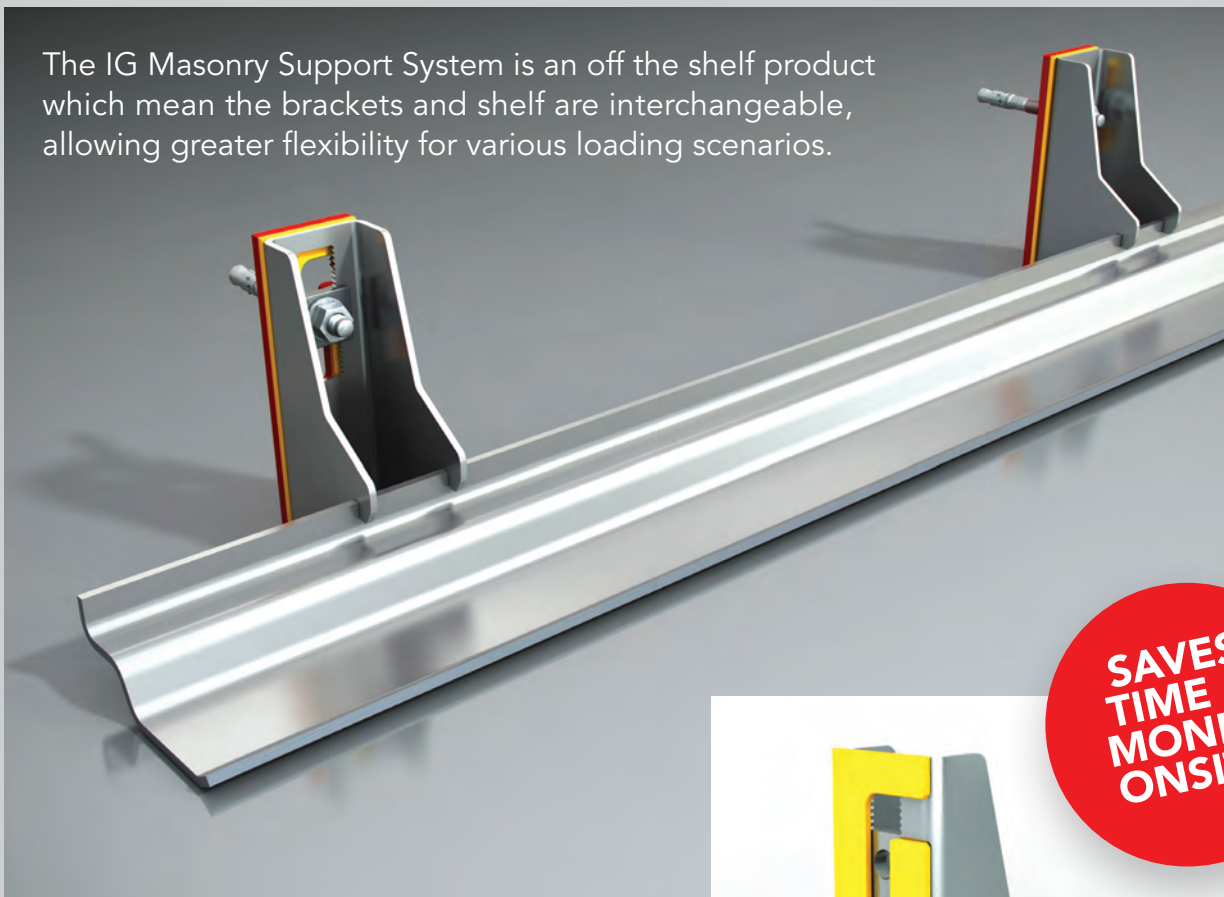

**SAVES
TIME &
MONEY
ONSITE**

- **CHOICE**
Cavity sizes range from 70mm to 150mm. Larger cavities are available on request.
- **FLEXIBILITY**
The Masonry Support System provides greater adjustment both vertically and horizontally compared to the traditional welded system.



RB Lintel



L8/RB Lintel

For use with integral concrete ring beams. The L8 RB type lintel must be bolted to the concrete ring beam at 400mm c/c using M16 anchor bolts.

The L8 RB type range can be supplied to facilitate various cavity widths: e.g. specify L8 RB 50, L8 RB 75, L8 RB 100.

LINTEL HOTLINE
01633 486486

Fax Back Enquiry Forms are also available for download.
www.iglintels.com/technical

Extra Heavy Duty Load

L8/RB50			
Manufactured length 150mm increments	600- 1500	1650- 3000	3150- 4800
Height 'h'	200	200	200
Thickness	2.5	2.9	3.2
Total UDL kN/m	7.5	7.5	7.5

50-65mm cavity

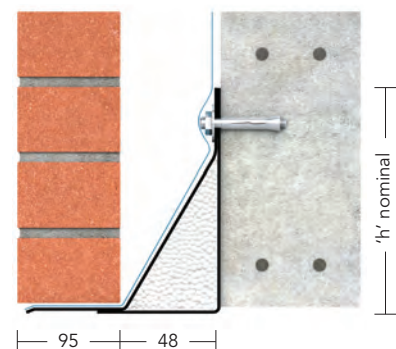

L8/RBW (Specify 75mm or 100mm cavity)			
Manufactured length 150mm increments	600- 1500	1650- 3000	3150- 4800
Height 'h'	200	200	200
Thickness	2.5	2.9	3.2
Total UDL kN/m	7.5	7.5	7.5

Specified cavity width

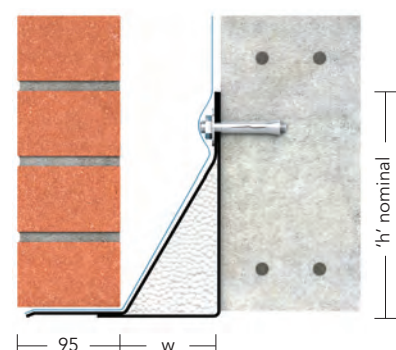

W = cavity width of 75mm or 100mm
Order L8/RBW and specify cavity width.

WINDPOSTS

STAINLESS STEEL WINDPOSTS FOR A RANGE OF LOADS

IG Windposts span vertically between floors to provide additional lateral support for large panels of brickwork or large panels with openings. IG manufacture three types of windposts.

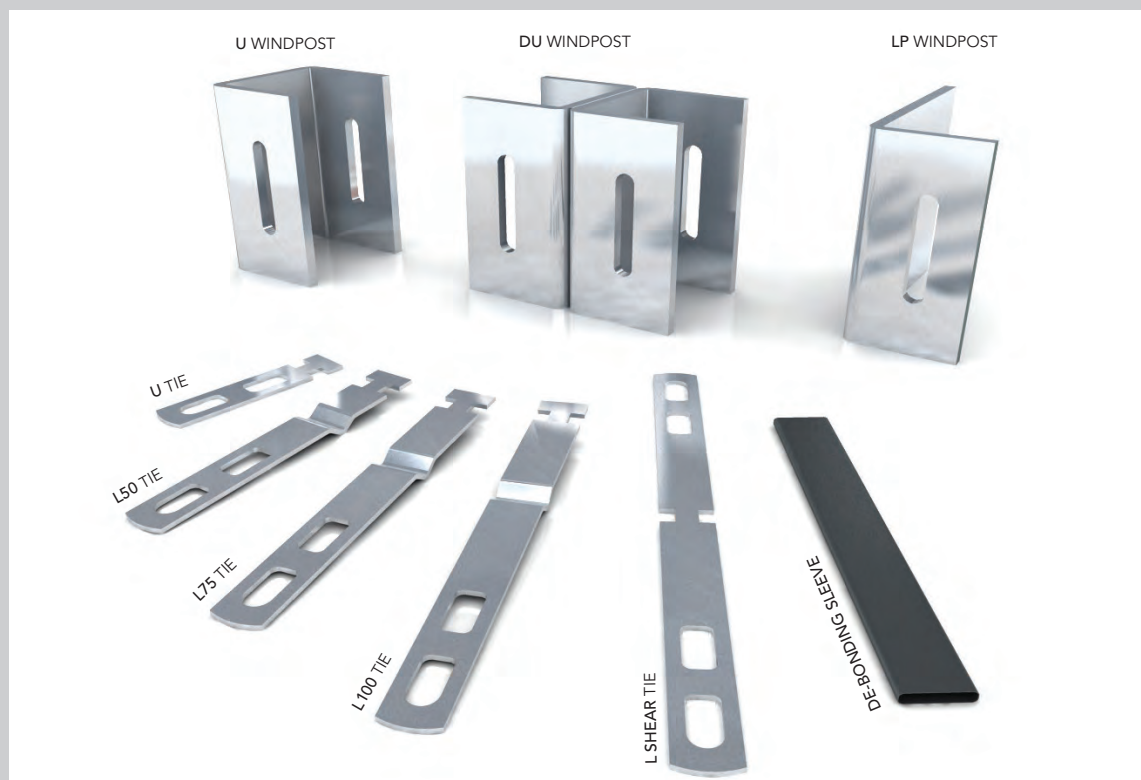

U Windpost

The U Windpost is a channel section designed for standard loading conditions and is installed within the cavity.

DU Windpost

The DU Windpost is a “back to back” channel section designed for heavier loading conditions and is installed within the cavity.

LP Windpost

The LP Windpost is an “L” shaped section designed to suit a range of loading conditions and is built into the inner skin of the cavity wall.

Material Specification

IG Windposts are manufactured from grade 304 stainless steel. The IG Technical Team will provide full product specification and schedules.

Windposts

IG U type windpost shown is fixed at the base to concrete and at the top to the underside of a steel beam.

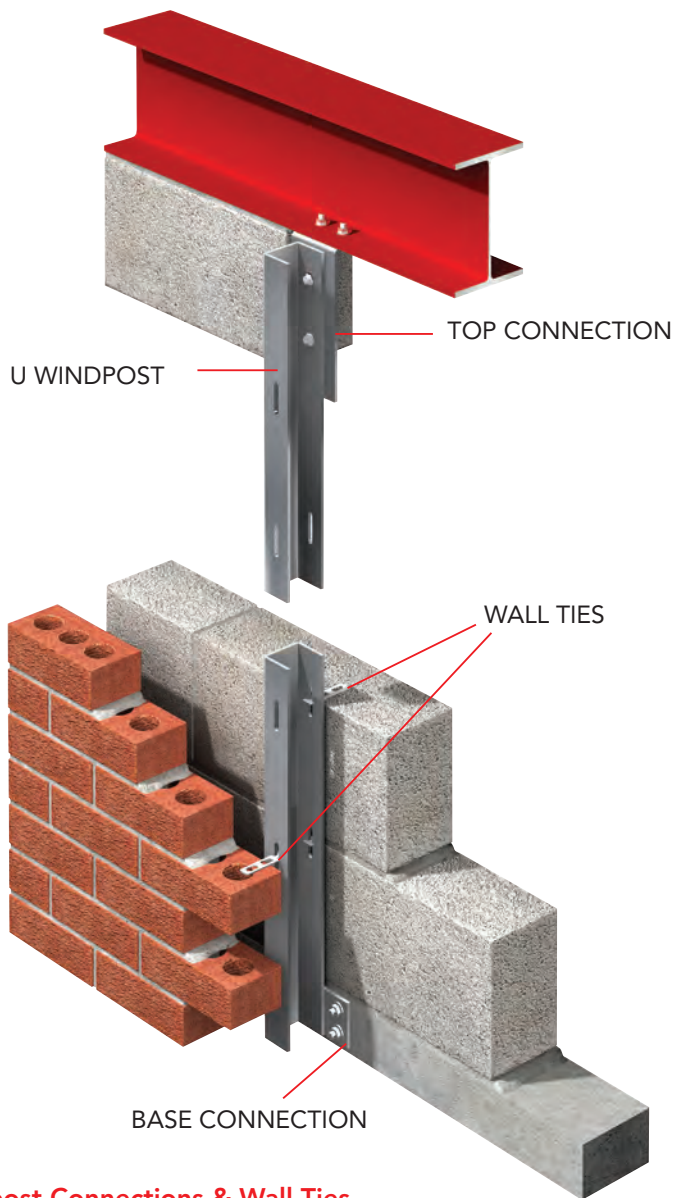

DU WINDPOST



U WINDPOST



LP WINDPOST



Windpost Connections & Wall Ties

All IG Windposts are supplied with specifically designed base and top connections. They are also supplied with a suitable number of wall-ties which will vary in relation to the post type used and the cavity width. There are five types of wall ties available.

U Tie	For use with U & DU Windposts.
L50	Tie – For use with LP Windposts.
L75 Tie	For use with LP Windposts.
L100 Tie	For use with LP Windposts.
L Shear Tie	For use with LP Windposts.

Note: L Shear Tie can be supplied with a de-bonding sleeve if the windpost is positioned at a vertical movement joint.

Stepped Triple Arch

A decorative entrance porch to a new entertainment complex.

PROJECT DETAILS

Spanning 7.2 metres in length this fully insulated, 400mm wide lintel provides full structural support for the entrance porch. To enhance the overall aesthetics of the bar front, the IG Engineer ensured that no steelwork was visible once construction was complete.

The structure also incorporates a steel ladder frame bolted to the vertical support posts. This frame provides a load bearing facility for the decorative wooden framing of the windows and doors.

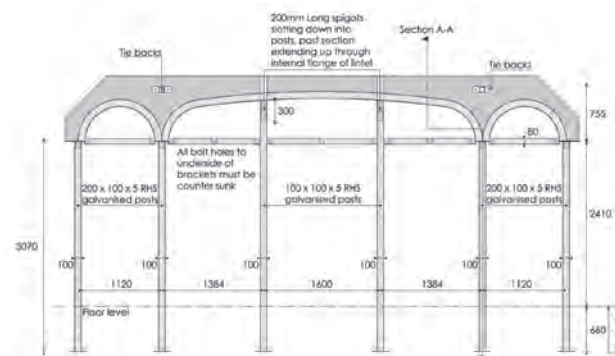

Stepped Triple Arch Lintel

Client :	M McElroy
Architect :	McCarter Hamill
Contractor :	McElroy
IG Engineer :	Chris Patterson

Glazed Gable Apex Sun Lounge

A key feature in this stunning home in Magherafelt.

PROJECT DETAILS

IG Engineer Paul Graham designed all the steel lintels for this property and was available on-site to assist the architect and builders. He also had to take into consideration the unusual wall construction which consisted of a double cavity of 100mm with two sections of block and one section of brick.

As well as the large Apex sun lounge, many other lintels were used to make this a beautiful family home, including a large 6m wide Arch lintel at the front of the property, a large double storey corner lintel and a ring beam corner lintel at the rear of the property.

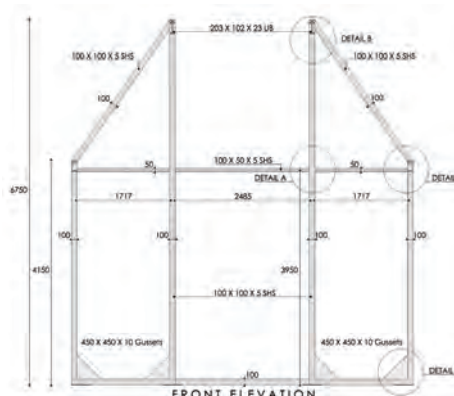

Glazed Gable Apex Sun Lounge

Client :	Private House
Architect :	G M Design
Contractor :	Higgins Construction
IG Engineer :	Paul Graham

Octagonal Portal Frame

Designed to cater for exclusive wedding ceremonies.

PROJECT DETAILS

Measuring 16 metres in length, with the main vaulted ceiling spanning 9.7 metres, this deluxe private wedding venue combines modern open space with elegant style.

The Octagonal Portal Frame was manufactured using a variety of steel beams, columns and sections bolted together to create a structural support for the building.



Octagonal Portal Frame

Client : Galgorm Manor Hotel

Architect : RPP Architects

Contractor : –

IG Engineer : Kyle Alexander

Glazed Gable Apex

Including cantilevered balcony.

PROJECT DETAILS

Televised in the BBC's "House of the Year 2010", this family home is a quintessential example of IG's innovative engineering. Working closely with Architect - Andrew Coulter, IG Engineer - Chris Patterson, detailed the unique two storey glazed gable apex with a cantilevered balcony, two story corner lintels and half apex corner lintels.

The apex portal frame is 8.5 metres high and spans 5 metres wide. IG also supplied a ridgebeam to bolt back from the apex of the gable frame to provide support for the vaulted ceiling. This diversity of steel framing was created using a combination of structural steel sections and supports.

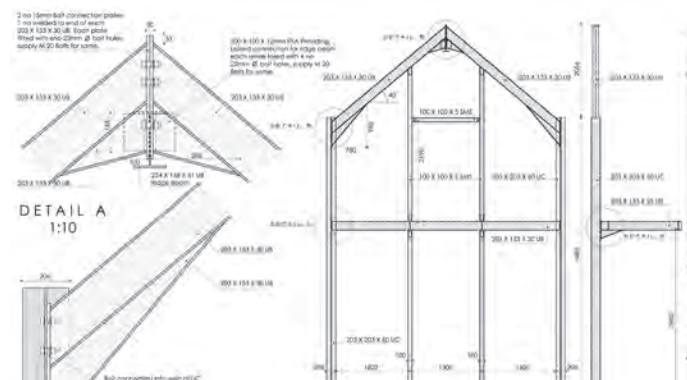

Glazed Gable Apex with Balcony

Client : Private

Architect : Andrew Coulter Architects

Contractor : H&J Martin

IG Engineer : Chris Patterson

Continuous Heavy Duty Arches

Agricultural, Food & Bio-Sciences Building.

PROJECT DETAILS

The original arches had been blocked up and supported by concrete lintels. The client wanted to reveal the traditional arches of the building and needed a support structure for the brickwork above. Due to the deterioration of the existing brickwork the contractor required further structural support and contacted the IG Technical Team to discuss a possible solution.

Steel pins were placed through the original stonework and supported from below. This suspended the upper floor of the building whilst the deteriorated bottom floor stonework was removed. IG posts were then put in place and the arches bolted on top. The original brick and stone were then replaced and the structural pins removed leaving IG's heavy duty arches to carry the load.

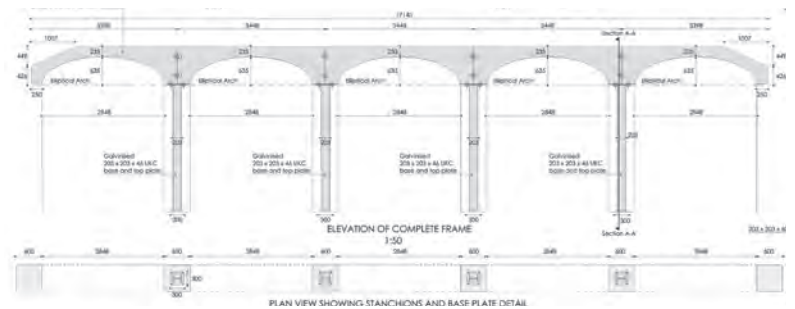

Continuous Heavy Duty Arches

Client :	Agri-Foods & Bio-Sciences
Architect :	Todd Architects
Contractor :	H&J Martin
IG Engineer :	Chris Patterson

Structural Apex Frame

A double height apex window frame.

PROJECT DETAILS

G.M. Design Architects called on IG's creative lintel department to detail this unique lintel. IG Engineer - Kyle Alexander, developed the structural steel framework to support the glazed gable apex and the roof structure above the balcony terrace.

Spanning 8 metres long and 4.5 metres high this complex steel frame was constructed from a range of steel sections.

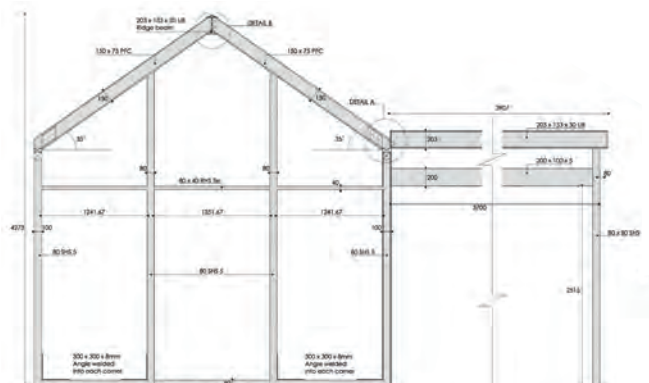

Structural Apex Frame

Client :	Private
Architect :	GM Design
Contractor :	Glebeview Builders
IG Engineer :	Kyle Alexander

Stepped Parabolic Corner

A stepped corner lintel with a parabolic arch.

PROJECT DETAILS

For this project, IG Engineer - Kyle Alexander designed a stepped corner lintel with a parabolic arch to suspend over 1 tonne of stone from the outer steel shelf. The lintel was designed to ensure that no steelwork was visible.

This system works by drilling holes into the outer steel shelf. Expansion plugs are then placed into the hanging sandstone and are bolted from above through the holes in the steel shelf. In addition to supporting the load of the hanging stone, the fully insulated lintel carries a 500mm wide wall structure above.

Spanning 7 metres along the front face and returning a further 3 metres at the corner, this special lintel is a prime example of how IG lintels can adapt to the client's brief.

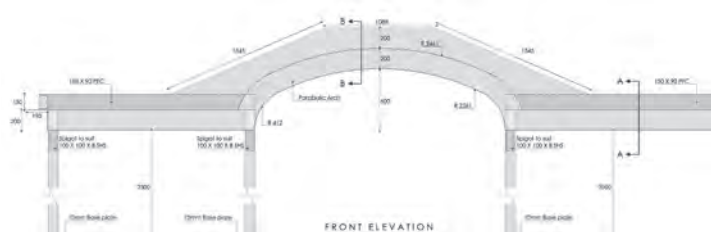

Stepped Parabolic Corner

Client :	Private
Architect :	Diamond Architecture
Contractor :	Self-build
IG Engineer :	Kyle Alexander

Angled Apex Frames

Private house, Ballykelly.

PROJECT DETAILS

The architect liaised with an IG engineer who had to take precise measurements onsite to create two very different but equally stunning Angled Apex Frames.

The Angled Apex Frame measured 4.8 metres high and 4 metres wide and included fully insulated 180mm box sections. The frames had to be delivered to site in two sections, these were bolted onsite via pre-drilled access holes.

The homeowner wanted to create a feature of not only the lintels used but also on the finishes, deciding on a natural stone finish for the outside of the house. Due to the stone finish IG had to include welded gusset plates to carry the stonework on the outer leaf and to resist against sliding.

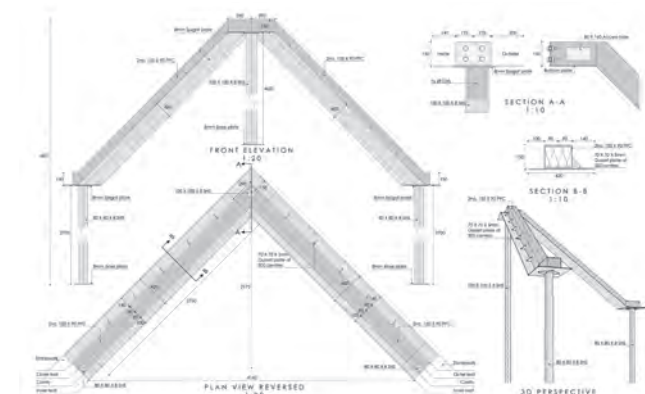

Angled Apex Frames

Client :	Private
Architect :	Hamilton Architects
Contractor :	-
IG Engineer :	Kyle Alexander

Triple Bow Sun Lounge

An elegant feature for a prestigious project.

PROJECT DETAILS

Due to the precise onsite measurements taken by IG's Engineer, the full steel structure could be slotted perfectly into place. Two parallel flange channels were rolled 'back to back' to create the 3.3 metre radius bows.

A steel plate which was curved on plan, was welded to the channels to facilitate blockwork on the outer flange. Two additional smaller bows with a radius of 1.25 metres create a lantern effect in the valuted ceiling of the sun lounge.

Spanning 6.5 metres in length with a total height of 4.7 metres this steel frame provides an elegant feature to this prestigious project.

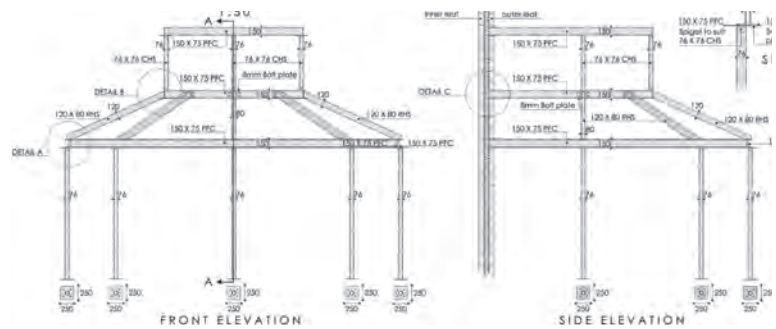

Triple Bow Sun Lounge

Client :	Private
Architect :	GM Design
Contractor :	J & D Mooney
IG Engineer :	Odhran McGoldrick

Cantilevered Walkway

Retrofit balcony and walkway.

PROJECT DETAILS

The steel structure was manufactured from a mixture of universal beams, square and circular hollow sections bolted to a concrete ring-beam in the existing building. Specially designed fin plate bolted connections secured the walkway to IG galvanized steel posts. The outer flange incorporates an extended leaf to facilitate 300mm stonework.

The most notable feature of this project is that, the IG engineers measured, designed and detailed every aspect of the walkway. This retrofit walkway proved to be a perfect example of how IG's team can be relied upon to design, manufacture and deliver onsite to the clients exact requirements.

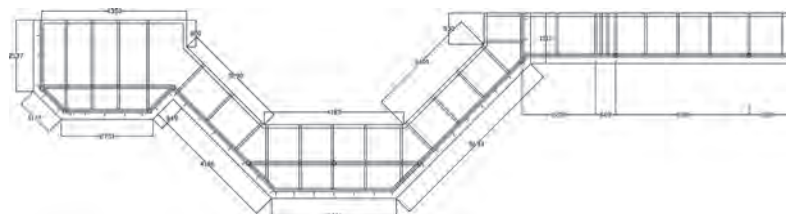

Cantilevered Walkway

Client :	Private
Architect :	-
Contractor :	John Ladden
IG Engineer :	Kyle Alexander

Venetian Arch Square Bay

Private house, Derbyshire.

PROJECT DETAILS

Contractor Hardwick Coleman and Whotten came to IG Lintels looking for a solution to form the spectacular entrance porch feature for this project in Derbyshire.

IG Engineer Andy Sharlot had a meeting onsite with the contractor and the reconstituted stone manufacturer to ensure the lintel and the stone would fit together. Andy then designed a bay with a full arch to each side leg and a Venetian arch to the front. The bay was designed to carry a full storey constructed from a 300mm wide cavity wall above the lintel and to support 580mm wide stone underneath the lintel. The lintel was then designed, manufactured and delivered to site and the lintel went up without a problem and all the stone fitted first time. IG proved that when something bespoke is required they can manufacture to the exact requirements.

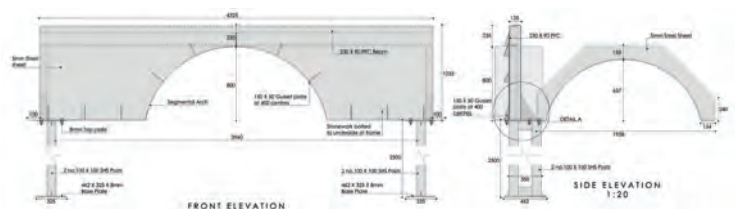

Stepped Parabolic Corner

Client :	Private
Architect :	Montague Architects
Contractor :	Hardwick Coleman & Whotton
IG Engineer :	Andy Sharlot

Special Arch Lintels & Colonnade Supports

Complex lintel solutions for a new build mansion

PROJECT DETAILS

Updown court, a neo classic georgian style home designed by US architects John B Scholz, provided enormous opportunities for creative lintel design.

IG designed and manufactured hundreds of special arch lintels and colonnade supports throughout this magnificent mansion. We also supplied numerous standard, heavy duty and extra heavy duty straight lintels.



Special Arches & Colonnade Supports

Client :	Private
Architect :	John B Scholz
Contractor :	-



CAVITY TRAYS



ROBUST AND COST EFFECTIVE CAVITY TRAY SYSTEM



RIDGE TRAY



CATCHMENT TRAY



LEFT HAND TRAY



RIGHT HAND TRAY

The IG Cavity Tray is a lightweight, simple to install and long lasting solution to preventing dampness from penetrating below the roof line.

Unique Products with Outstanding Benefits

Flexible: Three sizes cover all roof pitches, cavity widths up to 100mm and building materials.

- **Off-the-shelf:** Pre-creased, flat packed and easily hand folded onsite.
- **Robust:** Impact, tear and abuse resistant to last the lifetime of your building.
- **Compliant:** Meets all current Building Regulations and NHBC requirements.
- **Economic:** The most cost-effective Cavity Tray system available.
- **Durability:** Resistant to acid, alkali and sulphate.



INTERNAL CORNER TRAY



EXTERNAL CORNER TRAY



REFURBISHMENT TRAY

Mastic Sealant Strip

BETTER BY
DESIGN

IG
STEEL LINTELS

Hi-therm+

IG has redefined lintel performance with Hi-therm+, the low cost solution to reduced carbon emissions and improved Fabric Energy Efficiency (FEES).

Special Lintels

IG offers a complete custom design service to ensure your project has the best lintel for the job. Our technical expertise is renowned for delivering solutions with total efficiency.

Masonry Support & Windposts

IG continues to set the standard for masonry support and windpost systems for a range of building frame configurations. The innovative IG Masonry Support System provides a versatile solution when masonry support is required.

Standard Lintels

IG produces a wide range of standard galvanised steel and stainless steel lintels. All IG standard lintels satisfy the thermal performance requirements of all UK building regulations.

Brick Feature Lintels

IG Brick Feature Lintels are a one piece prefabricated unit, manufactured bespoke to order, achieving even the most challenging architectural designs.

Cavity Trays

The IG Cavity Tray presents a lightweight, simple to install and long-lasting solution to preventing damp from penetrating below the roof line.

iglintels.com

LINTEL HOTLINE

01633 486486

Email: sales@iglintels.com

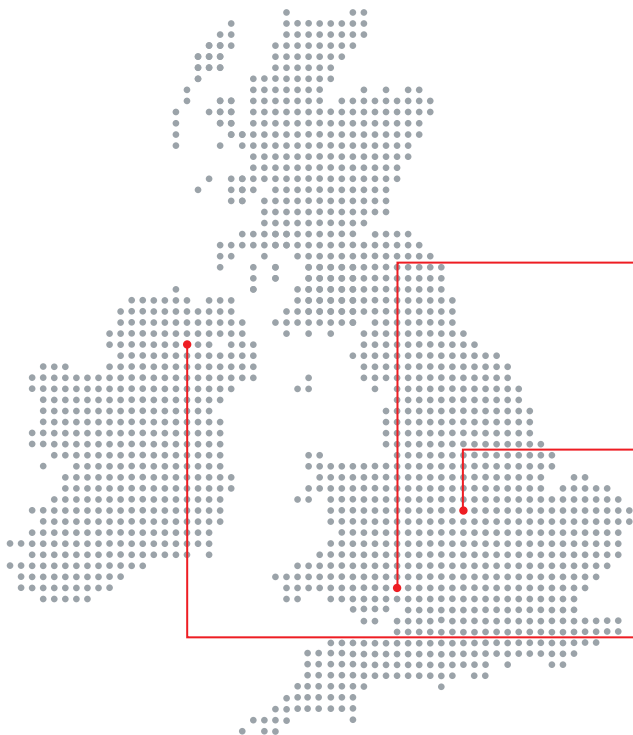

IG - CWMBRAN

Avondale Road, Cwmbran,
Gwent, NP44 1XY
T: +44 (0) 1633 486486
F: +44 (0) 1633 486465



IG - SWADLINCOTE

Ryder Close, Cadley Hill Industrial Estate
Swadlincote, South Derbyshire DE11 9EU
T: +44 (0) 1283 200150
F: +44 (0) 1283 223352



IG - IRELAND

Ballyreagh Industrial Estate,
Cookstown, Co. Tyrone BT80 9DG
T: +44 (0) 28 86762184
F: +44 (0) 28 86761011

