

concord

PVC ROOFLINE

roofline, cladding,
window boards, cills, and trims



Fax Order Line: 01827 316169

Issue 3 - July 2024

Concord now has a leading 20 Year Extended Guarantee

for its range of white cellular
PVC fascias, soffits and
claddings.

The Concord 20 Year Extended Guarantee applies when Concord white cellular PVC roofline profiles are installed on a property with either a Swish or Kayflow white rainwater system.

In order to offer this guarantee, installers must be registered at www.concordpvc.co.uk. Qualifying guarantees can also be registered at the same site*.

Concord Standard Guarantees

The Concord standard guarantee for white cellular PVC profiles is 15 years and the Guarantee for colour and foiled profiles is 10 Years.

*For full terms and conditions please see the Concord Extended Guarantee at www.concordpvc.co.uk.



accreditation



FS 681825

Concord cellular PVC-u profiles are designed and manufactured to stringent quality control standards in accordance with ISO 9001 2015.



Concord roofline and cladding systems are covered by BBA Certificate No's 02/3902 and 02/3898 respectively.



EMS 681826

The BSI Environmental Management System accreditation (BS EN ISO 14001) demonstrates the Company's commitment to comply with environmental laws and regulations and to continuously improve its environmental management systems



BS 7619

Licence No. KM33730

Concord cellular profiles have been tested and achieve the requirements stipulated for cellular PVC-u in BS.7619 which encompasses composition, weather resistance, colour fastness, surface finish, impact and fire performance.

Square Fascia (20mm)

| Code | Description | Colour | Pack Qty | Price Mtr (£) | Price Lgth (£) |
|--------|-----------------------------|--------|----------|---------------|----------------|
| JWF405 | 405mm Standard Fascia (D/E) | W | 1 | 51.69 | 258.43 |
| JWF355 | 355mm Standard Fascia (D/E) | W | 1 | 42.70 | 213.51 |
| JWF250 | 250mm Standard Fascia | W | 2 | 35.23 | 176.13 |
| JWF225 | 225mm Standard Fascia | W | 2 | 31.14 | 155.68 |
| JWF200 | 200mm Standard Fascia | W | 2 | 26.15 | 130.76 |
| JWF175 | 175mm Standard Fascia | W | 2 | 22.77 | 113.87 |
| JWF150 | 150mm Standard Fascia | W | 2 | 21.08 | 105.41 |

Square Fascia (16mm)

| Code | Description | Colour | Pack Qty | Price Mtr (£) | Price Lgth (£) |
|--------|---------------------------|--------|----------|---------------|----------------|
| CSF455 | 455mm Square Fascia (D/E) | W | 1 | 48.20 | 240.99 |
| CSF405 | 405mm Square Fascia (D/E) | W | 1 | 39.92 | 199.62 |
| CSF355 | 355mm Square Fascia (D/E) | W | 1 | 35.14 | 175.68 |
| CSF300 | 300mm Square Fascia | W | 1 | 33.56 | 167.78 |
| CSF250 | 250mm Square Fascia | W | 2 | 26.60 | 132.98 |
| CSF225 | 225mm Square Fascia | W | 2 | 23.84 | 119.20 |
| CSF200 | 200mm Square Fascia | W | 2 | 19.68 | 98.39 |
| CSF175 | 175mm Square Fascia | W | 2 | 17.75 | 88.74 |
| CSF150 | 150mm Square Fascia | W | 2 | 15.79 | 78.96 |

(Also available in Anthracite & Grey - see page 14 for details)

Prime Fascia (16mm)

| Code | Description | Colour | Pack Qty | Price Mtr (£) | Price Lgth (£) |
|--------|-----------------------------|--------|----------|---------------|----------------|
| FWB455 | 455mm Bullnose Fascia (D/E) | W | 1 | 48.20 | 240.99 |
| FWB405 | 405mm Bullnose Fascia (D/E) | W | 1 | 39.92 | 199.62 |
| FWB355 | 355mm Bullnose Fascia (D/E) | W | 1 | 35.14 | 175.68 |
| FWB250 | 250mm Bullnose Fascia | W | 2 | 26.60 | 132.98 |
| FWB225 | 225mm Bullnose Fascia | W | 2 | 23.84 | 119.20 |
| FWB200 | 200mm Bullnose Fascia | W | 2 | 19.68 | 98.39 |
| FWB175 | 175mm Bullnose Fascia | W | 2 | 17.75 | 88.74 |
| FWB150 | 150mm Bullnose Fascia | W | 2 | 15.79 | 78.96 |

Ogee Fascia (16mm)

| Code | Description | Colour | Pack Qty | Price Mtr (£) | Price Lgth (£) |
|--------|-------------------------|--------|----------|---------------|----------------|
| COF405 | 405mm Ogee Fascia (D/E) | W | 1 | 39.92 | 199.62 |
| COF355 | 355mm Ogee Fascia (D/E) | W | 1 | 35.14 | 175.68 |
| COF250 | 250mm Ogee Fascia | W | 2 | 26.60 | 132.98 |
| COF225 | 225mm Ogee Fascia | W | 2 | 23.84 | 119.20 |
| COF200 | 200mm Ogee Fascia | W | 2 | 19.68 | 98.39 |
| COF175 | 175mm Ogee Fascia | W | 2 | 17.75 | 88.74 |
| COF150 | 150mm Ogee Fascia | W | 2 | 15.79 | 78.96 |

Flat Fascia (16mm)

| Code | Description | Colour | Pack Qty | Price Mtr (£) | Price Lgth (£) |
|--------|-------------------------|--------|----------|---------------|----------------|
| CFF405 | 405mm Flat Fascia (D/E) | W | 1 | 39.92 | 199.62 |
| CFF250 | 250mm Flat Fascia | W | 2 | 26.60 | 132.98 |
| CFF225 | 225mm Flat Fascia | W | 2 | 23.84 | 119.20 |
| CFF200 | 200mm Flat Fascia | W | 2 | 19.68 | 98.39 |
| CFF175 | 175mm Flat Fascia | W | 2 | 17.75 | 88.74 |
| CFF150 | 150mm Flat Fascia | W | 2 | 15.79 | 78.96 |

W = White

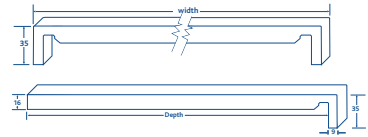
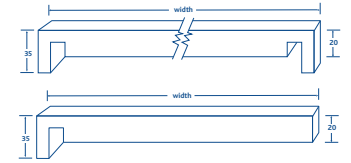

Note:
Mahogany, Light Oak, Rosewood, Black, Irish Oak, Anthracite Grey, White and Cream woodgrain foiled versions of this profile are also available. For further details see page 14.
For co-extruded colours Black, Light Grey and Anthracite Grey see page 8.

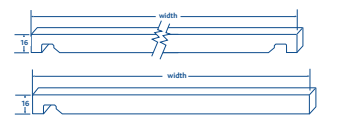
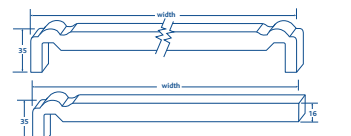
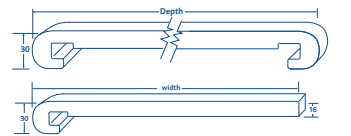

Square Fascia/Cover (9mm)

Depth measured internally

| Code | Description | Colour | Pack Qty | Price Mtr (£) | Price Lgth (£) |
|--------|---------------------------------|--------|----------|---------------|----------------|
| SFN595 | 595mm Square Fascia/Cover | W | 1 | 65.20 | 325.99 |
| SFN390 | 390mm Square Fascia/Cover | W | 1 | 32.09 | 160.44 |
| SFN385 | 385mm Square Fascia/Cover (D/E) | W | 1 | 33.03 | 165.16 |
| SFN290 | 290mm Square Fascia/Cover | W | 1 | 26.11 | 130.54 |
| SFN240 | 240mm Square Fascia/Cover | W | 2 | 21.17 | 105.87 |
| SFN225 | 225mm Square Fascia/Cover | W | 2 | 18.41 | 92.06 |
| SFN215 | 215mm Square Fascia/Cover | W | 2 | 18.05 | 90.23 |
| SFN200 | 200mm Square Fascia/Cover | W | 2 | 17.68 | 88.41 |
| SFN190 | 190mm Square Fascia/Cover | W | 2 | 16.05 | 80.24 |
| SFN175 | 175mm Square Fascia/Cover | W | 2 | 14.41 | 72.03 |
| SFN165 | 165mm Square Fascia/Cover | W | 2 | 14.14 | 70.70 |
| SFN150 | 150mm Square Fascia/Cover | W | 2 | 13.87 | 69.37 |
| SFN140 | 140mm Square Fascia/Cover | W | 2 | 12.77 | 63.86 |
| SFN090 | 90mm Square Fascia/Cover | W | 2 | 11.66 | 58.28 |

Ogee Fascia (9mm)

Depth measured externally

| Code | Description | Colour | Pack Qty | Price Mtr (£) | Price Lgth (£) |
|-------|-------------------------|--------|----------|---------------|----------------|
| CK405 | 405mm Ogee Fascia (D/E) | W | 1 | 38.34 | 191.70 |
| CK250 | 250mm Ogee Fascia | W | 2 | 22.94 | 114.72 |
| CK225 | 225mm Ogee Fascia | W | 2 | 20.73 | 103.63 |
| CK200 | 200mm Ogee Fascia | W | 2 | 18.50 | 92.50 |
| CK175 | 175mm Ogee Fascia | W | 2 | 16.19 | 80.93 |
| CK150 | 150mm Ogee Fascia | W | 2 | 14.41 | 72.03 |

Fascia/Cover (7mm)

Depth measured externally

| Code | Description | Colour | Pack Qty | Price Mtr (£) | Price Lgth (£) |
|-------|------------------------|--------|----------|---------------|----------------|
| PC455 | 455 x 7mm Fascia (D/E) | W | 2 | 26.68 | 133.42 |
| PC354 | 354 x 7mm Fascia (D/E) | W | 2 | 19.84 | 99.18 |
| PC250 | 250 x 7mm Fascia | W | 4 | 14.05 | 70.24 |
| PC225 | 225 x 7mm Fascia | W | 4 | 12.63 | 63.16 |
| PC200 | 200 x 7mm Fascia | W | 4 | 10.67 | 53.37 |
| PC175 | 175 x 7mm Fascia | W | 4 | 9.16 | 45.80 |
| PC150 | 150 x 7mm Fascia | W | 4 | 8.09 | 40.45 |

100mm and 300mm End Caps also available, see page 10.

Ogee Fascia (7mm)

Depth measured externally

| Code | Description | Colour | Pack Qty | Price Mtr (£) | Price Lgth (£) |
|-------|-----------------------------|--------|----------|---------------|----------------|
| PG455 | 455 x 7mm Ogee Fascia (D/E) | W | 1 | 28.91 | 144.55 |
| PG250 | 250 x 7mm Ogee Fascia | W | 2 | 15.12 | 75.59 |
| PG225 | 225 x 7mm Ogee Fascia | W | 4 | 13.18 | 65.90 |
| PG200 | 200 x 7mm Ogee Fascia | W | 4 | 10.87 | 54.35 |
| PG175 | 175 x 7mm Ogee Fascia | W | 4 | 9.60 | 48.02 |
| PG150 | 150 x 7mm Ogee Fascia | W | 4 | 8.56 | 42.80 |

W = White

Decorative Elements

| Code | Description | Colour | Pack Qty | Price Mtr (£) | Price Lgth (£) |
|--------|-------------------------------|--------|----------|---------------|----------------|
| DBVEX1 | Convex (165mm min/225mm max) | W | 2 | 34.98 | 174.88 |
| DBCVA1 | Concave (160mm min/225mm max) | W | 2 | 34.98 | 174.88 |

| Code | Description | Colour | Size mm | Pack Qty | Price Pack (£) |
|------|--------------|--------|---------|----------|----------------|
| DGF1 | Gable Finial | W | 340 | 10 | 95.38 |

Fascia/Soffit Trims

| Code | Description | Colour | Pack Qty | Price Mtr (£) | Price Lgth (£) |
|---------|---------------------|--------|----------|---------------|----------------|
| SMC100 | Soffit to wall trim | W | 10 | 5.35 | 26.77 |
| SMT1001 | Soffit Joint | W | 10 | 5.64 | 28.21 |
| CT038 | Felt Roof Edge Trim | W | 10 | 4.85 | 24.25 |

Soffit ventilators

| Code | Description | Colour | Pack Qty | Price Mtr (£) | Price Lgth (£) |
|---------|-----------------------------------|--------|----------|---------------|----------------|
| SVS5000 | 10mm Fascia/Soffit Ventilator (1) | W | 5 | 8.32 | 41.58 |
| SVT5000 | 25mm Fascia/Soffit Ventilator (2) | W | 5 | 11.35 | 56.76 |

NOTES: (1) 10mm Airflow (2) 25mm Airflow.

Over Fascia Protection/Ventilation

| Code | Description | Colour | Pk Qty | Price (£) |
|------|-----------------------------------|--------|--------|-----------|
| C502 | Fascia Protection (2.5m) | Z | 5 | 108.98 |
| C406 | Vented Eaves Protector (1m) | Z | 40 | 594.71 |
| C405 | Bird Comb (for C406Z) (1m) | Z | 30 | 59.47 |
| C504 | Over Fascia Ventilator -10mm (1m) | Z | 25 | 191.24 |
| C505 | Over Fascia Ventilator -25mm (1m) | Z | 20 | 207.18 |

Dry Verge Systems

Verge Master - Handed

| Code | Description | Colour | Pk Qty (£) | Price (£) |
|-----------|--------------------|----------|------------|-----------|
| DVLH**50 | Verge Unit Left | GR/BR/BL | 50 | 224.00 |
| DVRH**50 | Verge Unit Right | GR/BR/BL | 50 | 224.00 |
| DVLH**30 | Starter Unit Left | GR/BR/BL | 30 | 86.40 |
| DVRH**30 | Starter Unit Right | GR/BR/BL | 30 | 86.40 |
| DVRCA**10 | Angled Ridge Cap | GR/BR/BL | 10 | 54.40 |
| DVRCR**10 | Round Ridge Cap | GR/BR/BL | 10 | 54.40 |
| DVBEC50* | Batten End Clip | | 50 | 64.00 |

Verge Wizard - Universal

| Code | Description | Colour | Pk Qty (£) | Price (£) |
|-----------|------------------|----------|------------|-----------|
| DVU**60 | Verge Unit | GR/BR/BL | 60 | 194.00 |
| DVUS**30 | Starter Unit | GR/BR/BL | 30 | 74.40 |
| DVRCA**10 | Angled Ridge Cap | GR/BR/BL | 10 | 54.40 |
| DVRCR**10 | Round Ridge Cap | GR/BR/BL | 10 | 54.40 |
| DVBEC50* | Batten End Clip | | 50 | 64.00 |

* The batten end clip is stainless steel and not coloured ** Please enter colour code here when ordering
More information can be found at www.dryvergesystems.co.uk GR = Grey BR = Brown BL = Black

W = White Z = Black

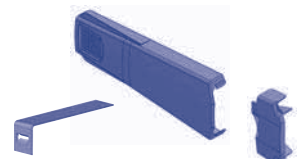
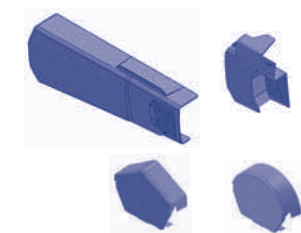
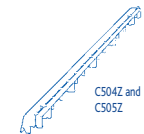
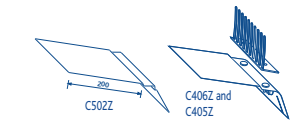
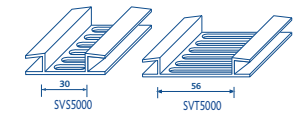
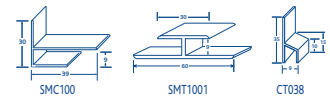
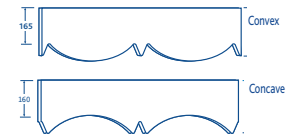

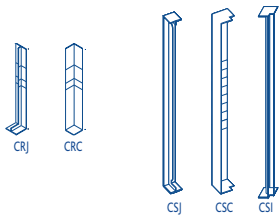

Corners and Joints

Square Corners & Joints

| Code | Description | Colour | Size mm | Pack Qty | Price Pack (£) |
|------|----------------------------|--------|---------|----------|----------------|
| CRJ | Square Fascia Joint | W | 300 | 10 | 51.17 |
| CRC | Square 90° Fascia Corner | W | 300 | 10 | 68.94 |
| CSJ | Square Face-fix Joint | W | 500 | 2 | 22.23 |
| CFJ* | Flat Face-fix Joint | W | 500 | 2 | 22.23 |
| CSC | Square 90° Face-fix Corner | W | 500 | 2 | 24.47 |
| CSI | Square 90° Internal Corner | W | 500 | 2 | 24.47 |

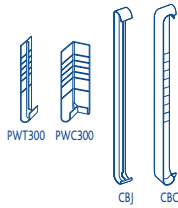

Prime Corners & Joints

| | | | | | |
|--------|--------------------------------------|---|-----|----|-------|
| PWC300 | Prime 90° Corner (Bullnose) | W | 300 | 10 | 75.41 |
| PWT300 | Prime Joint (Bullnose) | W | 300 | 10 | 68.57 |
| CBJ | Prime Joint (Bullnose) | W | 500 | 2 | 22.23 |
| CBC | Prime 90° Corner (Bullnose) | W | 500 | 2 | 24.47 |
| CBJ* | Prime 90° Internal Corner (Bullnose) | W | 500 | 2 | 22.76 |

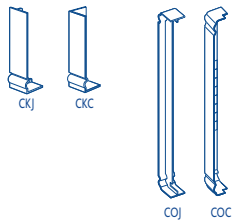

Ogee Corners & Joints

| | | | | | |
|------|----------------------------|---|-----|----|-------|
| CKJ | Ogee Joint | W | 300 | 10 | 51.17 |
| CKC | Ogee 90° Corner | W | 300 | 10 | 68.94 |
| COJ | Ogee Joint | W | 500 | 2 | 22.23 |
| COC | Ogee 90° Corner | W | 500 | 2 | 24.47 |
| COI* | Ogee 90° Internal Corner** | W | 500 | 2 | 24.47 |

**Suitable for 7mm boards only

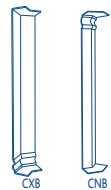

135° Ogee/Square Corners

| | | | | | |
|-----|----------------------|---|-----|---|--------|
| CXB | 135° External Corner | W | 410 | 5 | 149.61 |
| CNB | 135° Internal Corner | W | 410 | 5 | 162.87 |

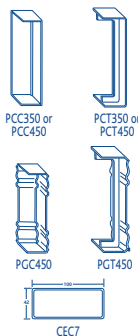

For 7mm boards only

| | | | | | |
|--------|---------------------------|---|-----|----|-------|
| PCC350 | Square 90° Corner | W | 362 | 10 | 72.28 |
| PCT350 | Square Joint | W | 362 | 10 | 56.72 |
| PCC450 | Square 90° Corner | W | 462 | 10 | 92.27 |
| PCT450 | Square Joint | W | 462 | 10 | 73.37 |
| PGC450 | Ogee 90° Ext. Corner | W | 462 | 10 | 92.27 |
| PGT450 | Ogee Joint | W | 462 | 10 | 73.37 |
| CEC7 | 100mm Cover Board End Cap | W | 100 | 10 | 18.81 |
| CEC10* | 300mm Cover Board End Cap | W | 300 | 10 | 24.68 |

W=White
*not illustrated

Soffit Multi-Purpose Boards (9mm)

| Code | Description | Colour | Pack Qty | Price Mtr (£) | Price Lgth (£) |
|---------|---------------------------------|--------|----------|---------------|----------------|
| SM605 | 605mm Soffit | W | 1 | 53.37 | 266.87 |
| SM500 | 500mm Soffit | W | 1 | 44.10 | 220.48 |
| SM450 | 450mm Soffit | W | 1 | 35.58 | 177.92 |
| SM405 | 405mm Soffit | W | 1 | 30.46 | 152.30 |
| SM300 | 300mm Soffit | W | 2 | 23.66 | 118.31 |
| SM250 | 250mm Soffit | W | 2 | 20.97 | 104.83 |
| SM225 | 225mm Soffit | W | 2 | 16.05 | 80.27 |
| SM201 | 200mm Soffit | W | 2 | 15.12 | 75.59 |
| SM175 | 175mm Soffit | W | 2 | 14.96 | 74.82 |
| SM150 | 150mm Soffit | W | 2 | 11.72 | 58.60 |
| SM100 | 100mm Soffit | W | 5 | 6.94 | 34.69 |
| SM100F | 100mm Soffit (2 finished edges) | W | 5 | 7.56 | 37.81 |
| SM300GW | 300mm Soffit (grooved) | W | 2 | 24.21 | 121.06 |

Hollow Soffit Profiles

| | | | | | |
|--------|-------------------------------|-------|----|-------|-------|
| H300 | 300mm Hollow Soffit | W | 4 | 8.39 | 41.96 |
| H250 | 250mm Hollow Soffit | W | 4 | 7.97 | 39.85 |
| H100 | 100mm Hollow Soffit | W | 10 | 3.52 | 17.59 |
| HST | Hollow Soffit Edge Trim | W | 10 | 2.86 | 14.30 |
| HJT | Hollow Soffit Joint | W | 10 | 3.56 | 17.78 |
| J300 | 300mm Hollow Soffit | A/B | 5 | 10.30 | 51.52 |
| J100 | 100mm Hollow Soffit | W | 10 | 2.78 | 13.92 |
| JST | Hollow Soffit Starter | A/B/G | 10 | 5.72 | 28.60 |
| JJT | Hollow Soffit Joint | A/B/G | 10 | 7.11 | 35.55 |
| RSB250 | 250mm Hollow Soffit (4 Plank) | W | 5 | 6.00 | 30.00 |
| RCH300 | 300mm Hollow Soffit | W | 5 | 7.40 | 37.00 |
| SUB300 | 300mm Hollow Soffit | W | 5 | 6.60 | 33.00 |
| SUB300 | 300mm Hollow Soffit | A/B/G | 5 | 8.40 | 42.00 |

Vented Soffit (9mm) 10mm Air Gap

| | | | | | |
|--------|-------------------------|---|---|-------|--------|
| SM605V | 605mm Pre-Vented Soffit | W | 1 | 54.22 | 271.08 |
| SM450V | 450mm Pre-Vented Soffit | W | 1 | 39.94 | 199.72 |
| SM405V | 405mm Pre-Vented Soffit | W | 1 | 35.49 | 177.45 |
| SM300V | 300mm Pre-Vented Soffit | W | 2 | 28.00 | 139.98 |
| SM250V | 250mm Pre-Vented Soffit | W | 2 | 23.57 | 117.87 |
| SM225V | 225mm Pre-Vented Soffit | W | 2 | 21.90 | 109.52 |
| SM200V | 200mm Pre-Vented Soffit | W | 2 | 20.46 | 102.30 |
| SM175V | 175mm Pre-Vented Soffit | W | 2 | 19.13 | 95.63 |
| SM150V | 150mm Pre-Vented Soffit | W | 2 | 15.81 | 79.05 |

Vented Soffit (9mm) 25mm Air Gap

| | | | | | |
|--------|-------------------------|---|---|-------|--------|
| SN450V | 450mm Pre-Vented Soffit | W | 1 | 42.64 | 213.22 |
| SN300V | 300mm Pre-Vented Soffit | W | 2 | 29.08 | 145.39 |
| SN225V | 225mm Pre-Vented Soffit | W | 2 | 23.00 | 114.98 |
| SN150V | 150mm Pre-Vented Soffit | W | 2 | 16.91 | 84.54 |

W=White A=Black B=Brown G=Anthracite Grey

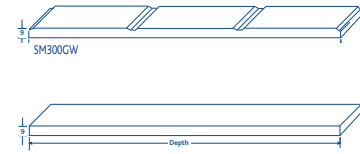

Note:
Mahogany, Light Oak, Rosewood, Black, Irish Oak, Anthracite Grey, Agate Grey, White and Cream woodgrain foiled versions of this profile are also available. For further details see page 14. For co-extruded colours Black, Light Grey and Anthracite Grey see page 8.

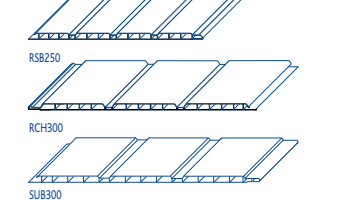
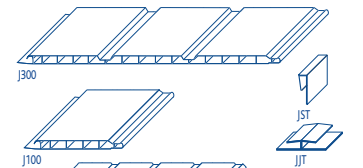
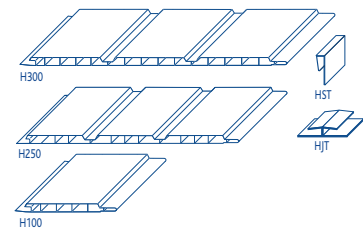

Note:
Mahogany, Light Oak, Rosewood, Black, Anthracite Grey, Agate Grey woodgrain foiled versions of this profile are also available. For further details see page 14.



SHADES of GREY (co-extruded) Roofline Profiles

Square Fascia (16mm)

| Code | Description | Colour | Pack Qty | Price Mtr (£) | Price Lgth (£) |
|--------|---------------------------|--------|----------|---------------|----------------|
| CSF405 | 405mm x 16mm Fascia (D/E) | A/E/G | 1 | 70.13 | 350.66 |
| CSF355 | 355mm x 16mm Fascia (D/E) | A/E/G | 1 | 60.39 | 301.94 |
| CSF250 | 250mm x 16mm Fascia | A/E/G | 2 | 47.78 | 238.90 |
| CSF225 | 225mm x 16mm Fascia | A/E/G | 2 | 42.38 | 211.88 |
| CSF200 | 200mm x 16mm Fascia | A/E/G | 2 | 35.47 | 177.35 |
| CSF175 | 175mm x 16mm Fascia | A/E/G | 2 | 30.82 | 154.10 |
| CSF150 | 150mm x 16mm Fascia | A/E/G | 2 | 28.51 | 142.55 |

Fascia/Cover (9mm)

| Code | Description | Colour | Pack Qty | Price Mtr (£) | Price Lgth (£) |
|--------|---------------------------------|--------|----------|---------------|----------------|
| SFN405 | 405mm Square Fascia/Cover (D/E) | A/E/G | 1 | 50.52 | 252.58 |
| SFN225 | 225mm Square Fascia/Cover | A/E/G | 2 | 26.27 | 131.35 |
| SFN200 | 200mm Square Fascia/Cover | A/E/G | 2 | 23.43 | 117.15 |
| SFN175 | 175mm Square Fascia/Cover | A/E/G | 2 | 21.09 | 105.45 |

| Code | Description | Colour | Pack Qty | Price Mtr (£) | Price Lgth (£) |
|-------|-------------------------------|--------|----------|---------------|----------------|
| CK405 | 405mm Ogee Fascia/Cover (D/E) | A | 1 | 50.52 | 252.58 |
| CK250 | 250mm Ogee Fascia/Cover | A | 1 | 31.57 | 157.87 |
| CK225 | 225mm Ogee Fascia/Cover | A | 2 | 26.27 | 131.35 |
| CK200 | 200mm Ogee Fascia/Cover | A | 2 | 23.43 | 117.15 |
| CK175 | 175mm Ogee Fascia/Cover | A | 2 | 21.09 | 105.45 |
| CK150 | 150mm Ogee Fascia/Cover | A | 2 | 18.94 | 94.72 |

9mm Capped in foiled and colour finishes is not suitable for use as a fascia board or bargeboard

Soffit/Multi-Purpose Boards (9mm)

| Code | Description | Colour | Pack Qty | Price Mtr (£) | Price Lgth (£) |
|---------|------------------------|--------|----------|---------------|----------------|
| SM605 | 605mm x 9mm Flat Board | G | 1 | 73.46 | 367.30 |
| SM405 | 405mm x 9mm Flat Board | A/E/G | 1 | 44.91 | 224.54 |
| SM300 | 300mm x 9mm Flat Board | A/E/G | 2 | 36.73 | 183.63 |
| SM200 | 200mm x 9mm Flat Board | A/E/G | 2 | 20.33 | 101.63 |
| SM150 | 150mm x 9mm Flat Board | A/E/G | 2 | 15.12 | 75.58 |
| SMT1001 | Soffit Joint Trim | A/E/G | 10 | 10.80 | 54.01 |
| SVT5000 | 25mm Soffit Ventilator | A | 5 | 12.37 | 61.85 |

Corners & Joints

| Code | Description | Colour | Pack Qty | Price Mtr (£) | Price Lgth (£) |
|------|-----------------------------------|--------|----------|---------------|----------------|
| CSJ | Square Face-Fix Joint (500mm) | A/E/G | 2 | - | 60.71 |
| CSC | Square Face-Fix Corner (500mm) | A/E/G | 2 | - | 70.03 |
| CSI | Square Internal Corner (500mm) | A/E/G | 2 | - | 85.21 |
| CRJ | Square Fascia Joint (300mm) | A/E/G | 10 | - | 122.36 |
| CRC | Square Fascia Corner (300mm) | A/E/G | 10 | - | 158.56 |
| CKC | Ogee Fascia Corner (300mm) | A | 10 | - | 158.56 |
| CKJ | Ogee Fascia Joint (300mm) | A | 10 | - | 122.36 |
| COI | Ogee Fascia Int. Corner (500mm) * | A | 2 | - | 85.21 |

A = Black E = Light Grey G = Anthracite Grey
*Not illustrated

Cladding System

| Code | Description | Colour | Pack Qty | Price Mtr (£) | Price Lgth (£) |
|-------|----------------------------|--------|----------|---------------|----------------|
| CS100 | 100mm Shiplap | W | 5 | 74.72 | 37.36 |
| CS150 | 150mm Shiplap | W* | 5 | 73.23 | 54.92 |
| CS300 | 300mm Shiplap (twin plank) | W | 2 | 84.21 | 126.32 |
| CV100 | 100mm Open V | W* | 5 | 74.72 | 37.36 |
| CV150 | 150mm Open V | W | 5 | 73.23 | 54.92 |
| CF125 | 125mm Feather Edge | W | 5 | 73.28 | 45.80 |

Cladding Trims

| Code | Description | Colour | Pack Qty | Price Mtr (£) | Price Lgth (£) |
|-------|--------------------------------|--------|----------|---------------|----------------|
| CT026 | Universal Channel | W | 10 | 4.09 | 20.47 |
| CT040 | Universal Channel + Cover | W | 10 | 4.71 | 23.53 |
| CT290 | 2-Part Universal Trim (Male) | W | 10 | 4.79 | 23.93 |
| CT291 | 2-Part Universal Trim (Female) | W | 10 | 4.79 | 23.93 |
| CT030 | External Corner Trim | W | 5 | 9.33 | 46.63 |
| CT292 | 2-Part Corner Trim (Male) | W | 5 | 5.51 | 27.56 |
| CT294 | 2-Part Corner Trim (Female) | W | 5 | 8.11 | 40.56 |
| CT027 | Universal Starter | W | 10 | 4.62 | 23.11 |
| CT028 | Wall Starter | W | 10 | 4.49 | 22.43 |
| CT029 | Drip Starter | W | 10 | 6.57 | 32.84 |
| CT035 | Drip Trim | W | 10 | 6.28 | 31.40 |
| CT033 | Centre Joint | W | 5 | 8.90 | 44.49 |
| CT051 | 2-Part Joint (Male) | W | 5 | 4.22 | 21.10 |
| CT052 | 2-Part Joint (Female) | W | 5 | 6.31 | 31.57 |

| Code | Description | Colour | Pack Qty | Price Mtr (£) | Price Lgth (£) |
|-------|--------------------------|--------|----------|---------------|----------------|
| CJ042 | 100mm Shiplap Joint | W | 10 | 15.78 | |
| CJ043 | 150mm Shiplap Joint | W | 10 | 14.45 | |
| CJ045 | 300mm Shiplap Joint | W | 5 | 16.76 | |
| CJ281 | 100mm Open V joint | W | 10 | 15.78 | |
| CJ044 | 150mm Open V joint | W | 10 | 14.45 | |
| CJ057 | 125mm Feather Edge joint | W | 10 | 14.45 | |

Fixings

| Code | Description | Colour | Pack Qty | White (£) | Colours (£) |
|------|---------------------------|--------------|----------|-----------|-------------|
| C083 | 65mm Plastic Headed Nails | All Finishes | 100 | 29.54 | 34.65 |
| C082 | 50mm Plastic Headed Nails | W/Z | 100 | 26.77 | 30.90 |
| C081 | 40mm Plastic Headed Pins | All Finishes | 250 | 35.47 | 40.95 |
| C080 | 30mm Plastic Headed Pins | W | 250 | 31.90 | - |
| C204 | 30mm Fixing Pins | S | 250 | 12.69 | - |
| C203 | 25mm Fixing Pins | S | 250 | 12.13 | - |

W = White Z=Black S=Stainless Steel
*Additional colours available page 16

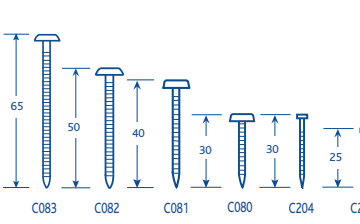
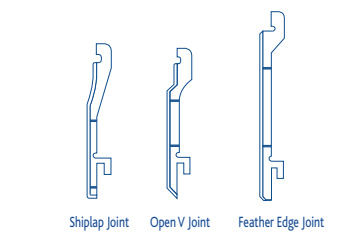
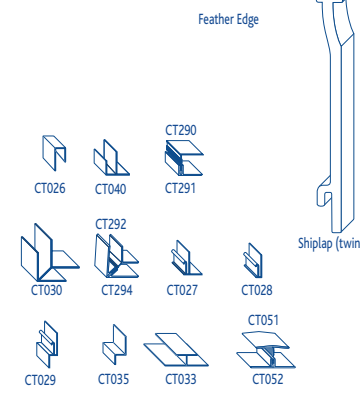
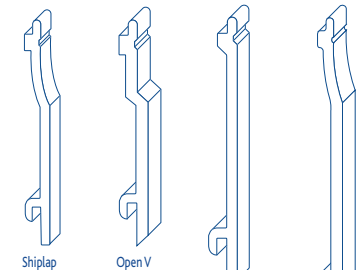

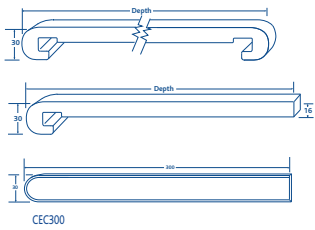

Prime Window Boards (16mm)

| Code | Description | Colour | Pack Qty | Price Mtr (£) | Price Lgth (£) |
|-----------|-----------------------------|--------|----------|----------------|----------------|
| FWB455 | 455mm Bullnose Fascia (D/E) | W | 1 | 48.20 | 240.99 |
| FWB405 | 405mm Bullnose Fascia (D/E) | W | 1 | 39.92 | 199.62 |
| FWB355 | 355mm Bullnose Fascia (D/E) | W | 1 | 35.14 | 175.68 |
| FWB250 | 250mm Bullnose Fascia | W | 2 | 26.60 | 132.98 |
| FWB225 | 225mm Bullnose Fascia | W | 2 | 23.84 | 119.20 |
| FWB200 | 200mm Bullnose Fascia | W | 2 | 19.68 | 98.39 |
| FWB175 | 175mm Bullnose Fascia | W | 2 | 17.75 | 88.74 |
| FWB150 | 150mm Bullnose Fascia | W | 2 | 15.79 | 78.96 |
| Code | Description | Colour | Pack Qty | Price Pack (£) | |
| CEC300W10 | Prime End cap (300mm) | W | 10 pairs | 49.62 | |

Bullnose Window Boards (9mm)

| Code | Description | Colour | Pack Qty | Price Mtr (£) | Price Lgth (£) |
|--------|-----------------------------|--------|----------|---------------|----------------|
| BNW405 | 405mm Bullnose Window Board | W | 1 | 32.47 | 162.36 |
| BNW300 | 300mm Bullnose Window Board | W | 2 | 24.28 | 121.41 |
| BNW250 | 250mm Bullnose Window Board | W | 2 | 20.24 | 101.18 |
| BNW225 | 225mm Bullnose Window Board | W | 2 | 19.13 | 95.63 |
| BNW200 | 200mm Bullnose Window Board | W | 2 | 17.79 | 88.94 |
| BNW175 | 175mm Bullnose Window Board | W | 2 | 15.66 | 78.29 |
| BNW150 | 150mm Bullnose Window Board | W | 2 | 13.34 | 66.72 |

| Code | Description | Colour | Pack Qty | Price Pack (£) | |
|---------|--------------------------|--------|----------|----------------|--|
| CEC4W10 | Long B/N End Cap (300mm) | W | 10 | 22.23 | |
| CEC5W05 | B/N End Cap (135mm) | W | 5 | 7.90 | |

Reveal/Cover (9mm)

Depth measured internally

| Code | Description | Colour | Pack Qty | Price Mtr (£) | Price Lgth (£) |
|--------|---------------------------------|--------|----------|---------------|----------------|
| SFN595 | 595mm Square Reveal/Cover | W | 1 | 65.20 | 325.99 |
| SFN390 | 390mm Square Reveal/Cover | W | 1 | 32.09 | 160.44 |
| SFN385 | 385mm Square Reveal/Cover (D/E) | W | 1 | 33.03 | 165.16 |
| SFN290 | 290mm Square Reveal/Cover | W | 1 | 26.11 | 130.54 |
| SFN240 | 240mm Square Reveal/Cover | W | 2 | 21.17 | 105.87 |
| SFN225 | 225mm Square Reveal/Cover | W | 2 | 18.41 | 92.06 |
| SFN215 | 215mm Square Reveal/Cover | W | 2 | 18.05 | 90.23 |
| SFN200 | 200mm Square Reveal/Cover | W | 2 | 17.68 | 88.41 |
| SFN190 | 190mm Square Reveal/Cover | W | 2 | 16.05 | 80.24 |
| SFN175 | 175mm Square Reveal/Cover | W | 2 | 14.41 | 72.03 |
| SFN165 | 165mm Square Reveal/Cover | W | 2 | 14.14 | 70.70 |
| SFN150 | 150mm Square Reveal/Cover | W | 2 | 13.87 | 69.37 |
| SFN140 | 140mm Square Reveal/Cover | W | 2 | 12.77 | 63.86 |
| SFN090 | 90mm Square Reveal/Cover | W | 2 | 11.66 | 58.28 |

| Code | Description | Colour | Pack Qty | Price Pack (£) | |
|---------|----------------------------------|--------|----------|----------------|--|
| CEC8W20 | Cover Board End Cap (50mm) | W | 20 | 22.23 | |
| CEC9W10 | Long Cover Board End Cap (300mm) | W | 10 | 22.23 | |

W = White

Window Trims

| Code | Description | Colour | Pack Qty | Price Mtr (£) | Price Lgth (£) |
|-------|-------------------------|--------|----------|---------------|----------------|
| ST45 | Flexible strip | W | 10 | 2.69 | 13.45 |
| ST75 | Flexible strip | W | 10 | 3.65 | 18.24 |
| SW60 | 9mm Channel | W | 20 | 1.97 | 9.86 |
| RQ12 | 12mm Quadrant | W | 20 | 1.27 | 6.33 |
| RQ17 | 17.5mm Quadrant | W | 20 | 1.71 | 8.56 |
| RQ20 | 20 x 15mm Bead | W | 20 | 3.20 | 16.00 |
| RS14 | 15 x 13mm Rectangle | W | 25 | 2.03 | 10.17 |
| RS25 | 25 x 20mm Rectangle | W | 10 | 5.93 | 29.64 |
| RS26 | 26 x 6mm Batten | W | 25 | 1.50 | 7.48 |
| RM22 | Scotia Mould | W | 20 | 1.86 | 9.29 |
| RL020 | 20mm Edge Mould | W | 25 | 1.24 | 6.20 |
| RA025 | 25mm x 25mm Angle | W | 20 | 1.77 | 8.86 |
| RA050 | 50mm x 50mm Angle | W | 10 | 6.67 | 33.37 |
| SA100 | 80 x 100mm Hollow Angle | W | 5 | 12.05 | 60.26 |
| RL025 | 25mm Dee Mould | W | 25 | 1.46 | 7.29 |
| RL028 | 28mm Dee Mould(f/b) | W | 25 | 1.57 | 7.87 |
| RE028 | 28mm Edge Trim | W | 25 | 1.84 | 9.20 |
| RL050 | 50mm Dee Mould | W | 10 | 3.28 | 16.42 |
| RL075 | 75mm Dee Mould | W | 10 | 4.19 | 20.96 |

Skirtings and Architraves

6mm Skirting/Architrave (Flat Backed)

| | | | | | |
|-------|-----------------|---|----|------|-------|
| RT045 | 45mm Architrave | W | 10 | 2.93 | 14.66 |
| RT070 | 70mm Skirting | W | 10 | 3.28 | 16.42 |
| RT095 | 95mm Skirting | W | 5 | 4.98 | 24.89 |

6mm Skirting/Architrave (Castellated)

| | | | | | |
|-------|-----------------|---|----|------|-------|
| RC045 | 45mm Architrave | W | 10 | 2.93 | 14.66 |
| RC070 | 70mm Skirting | W | 10 | 3.28 | 16.42 |
| RC095 | 95mm Skirting | W | 5 | 4.98 | 24.89 |

7mm Skirting/Architrave

| | | | | | |
|-------|---------------------------|---|----|------|-------|
| RP035 | 35mm Architrave | W | 10 | 2.48 | 12.42 |
| RP050 | 50mm Architrave/Skirting | W | 10 | 3.22 | 16.12 |
| RP075 | 75mm Architrave/Skirting | W | 10 | 3.56 | 17.78 |
| RP100 | 100mm Architrave/Skirting | W | 5 | 5.34 | 26.68 |
| RP125 | 125mm Skirting | W | 5 | 6.76 | 33.80 |

12mm Skirting/Architrave

| | | | | | |
|-------|--------------------|---|----|------|-------|
| RP045 | 45mm Architrave | W | 10 | 3.82 | 19.12 |
| RP070 | 70mm Skirting | W | 10 | 4.98 | 24.89 |
| RP095 | 95mm Ogee Skirting | W | 5 | 9.18 | 45.91 |

Decorative Profiles

| | | | | | |
|-------|--------------------|---|-----|-------|--------|
| OG070 | Classic Architrave | W | 5.3 | 11.54 | 61.16 |
| OG125 | Classic Architrave | W | 5 | 20.14 | 100.72 |

W = White

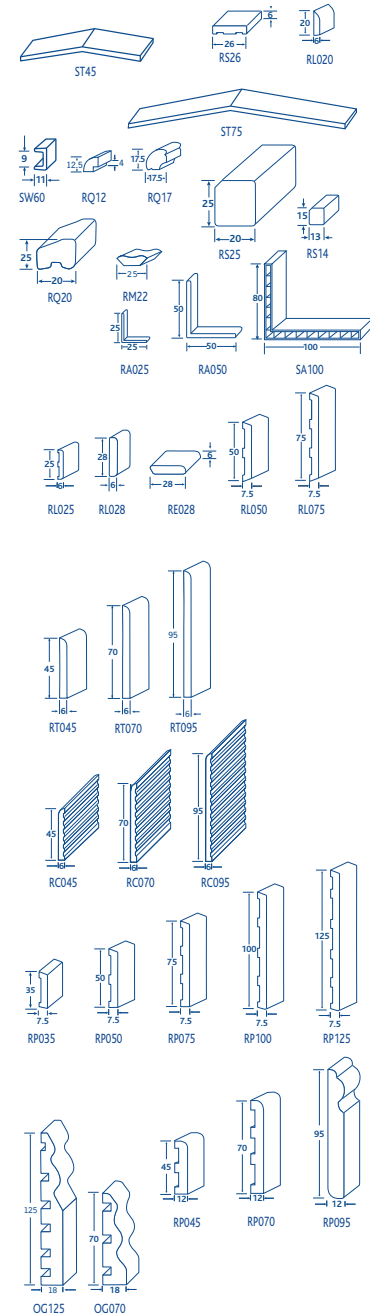

Plaslyne Angles & Rigid Window Boards

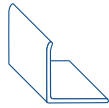

Solid Angle



Flexi Angle



Rigid Window Board



End Cap

Angles

| Code | Description | Std Length | Pack Qty | Colour | Price Lgth (£) |
|------------|--------------------------|------------|----------|--------|----------------|
| PSA23X65 | 23 X 65mm Solid Angle | 5m | 10 | B | 8.12 |
| PSA25x25 | 25 x 25mm Solid Angle | 5m | 20 | B | 3.68 |
| PSA32x32 | 32 x 32mm Solid Angle | 5m | 10 | B | 5.60 |
| PSA40x40 | 40 x 40mm Solid Angle | 5m | 20 | B | 7.26 |
| PSA50x50 | 50 x 50mm Solid Angle | 5m | 10 | B | 8.84 |
| PSA60x60 | 60 x 60mm Solid Angle | 5m | 10 | B | 16.80 |
| PSA80x80 | 80 x 80mm Solid Angle | 5m | 5 | B | 19.98 |
| PSA100x100 | 100 x 100mm Solid Angle | 5m | 5 | B | 25.53 |
| PFL50 | 50mm Flexi Angle | 5m | 5 | B | 6.40 |
| PFL70 | 75mm Flexi Angle | 5m | 10 | B | 8.20 |
| PFL100 | 100mm Flexi Angle | 5m | 10 | B | 9.60 |
| PFL150 | 150mm Flexi Angle | 5m | 5 | B | 27.08 |
| PWB175 | 175mm Rigid Window Board | 5m | 2 | B | 19.00 |
| PWB245 | 245mm Rigid Window Board | 5m | 2 | B | 23.80 |
| PWBBCAP | 100mm End Cap | - | 50 | B | 13.86pk |

Keyboard Laminated Window Boards

Bullnose (22mm thick)

| Code | Description | Std Length | Pack Qty | Price (W) (£) | Price (WG) (£) | Price (LO) (£) | Price (RW) (£) | Price (P) (£) |
|----------|------------------------------|------------|----------|---------------|----------------|----------------|----------------|---------------|
| KB150 | 150mm Bullnose Window Board | 5m | 1 | 36.45 | - | 36.45 | 36.45 | - |
| KB180 | 180mm Bullnose Window Board | 5m | 1 | 42.20 | - | 42.20 | 42.20 | 42.20 |
| KB200 | 200mm Bullnose Window Board | 5m | 1 | 43.38 | 43.38 | 43.38 | 43.38 | 43.38 |
| KB225 | 225mm Bullnose Window Board | 5m | 1 | 48.96 | 48.96 | 48.96 | 48.96 | 48.96 |
| KB250 | 250mm Bullnoses Window Board | 5m | 1 | 52.62 | 52.62 | 52.62 | 52.62 | 52.62 |
| KB300305 | 300mm Bullnose Window Board | 3.05m | 1 | 44.66 | - | 44.66 | 44.66 | 44.66 |
| KB300 | 300mm Bullnose Window Board | 5m | 1 | 80.55 | - | 80.55 | 80.55 | 80.55 |
| KB6003 | 600mm Bullnose Window Board | 3.05m | 1 | 68.48 | - | 68.48 | 68.48 | 68.48 |
| KB900 | 900mm Bullnose Window Board | 3.05m | 1 | 106.36 | - | - | - | - |



Important Information:
Keyboard internal window boards are Melamine laminate, bonded to a P3 moisture resistant chipboard core.

Accessories

| Code | Description | Std Length | Pack Qty | Price (W) (£) | Price (WG) (£) | Price (LO) (£) | Price (RW) (£) | Price (P) (£) |
|-------|------------------------------|------------|----------|---------------|----------------|----------------|----------------|---------------|
| KBEC | End Cap (Plain) | - | 10 Pairs | 13.72 | 13.72 | 13.72 | - | - |
| KBMS | Internal Mitre Joint (Plain) | - | 10 Pairs | 21.58 | 21.58 | 21.58 | - | - |
| KBEMS | External Mitre Joint (Plain) | - | 10 Pairs | 32.97 | - | - | - | - |

Skirting and Architraves

| Code | Description | Std Length | Pack Qty | Price (W) (£) | Price (WG) (£) | Price (LO) (£) | Price (RW) (£) | Price (P) (£) |
|-------|-------------|------------|----------|---------------|----------------|----------------|----------------|---------------|
| KA68 | 68mm Ogee | 4.4m | 1 | 18.11 | - | 18.11 | - | 18.11 |
| KS94 | 94mm Torus | 4.4m | 1 | 18.78 | - | 18.78 | - | 18.78 |
| KS144 | 144mm Torus | 4.4m | 1 | 25.40 | - | 25.40 | - | 25.40 |

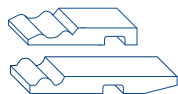

Skirting and Architrave profiles are polyester laminate bonded to a moisture resistant MDF core.

W = White WG = Mahogany LO = Light Oak RW = Rosewood P = Pine B = Brilliant White

Foiled Profiles - Roofline

Replacement Fascia (16mm)



| Code | Description | Std Length | Pack Qty | Price (M) (£) | Price (C) (£) | Price (R) (£) | Price (Q) (£) | Price (Z) (£) | Price (X) (£) | Price (K) (£) | Price (D) (£) | Price (AG) (£) |
|--------|---------------------------|------------|----------|------------------|------------------|------------------|------------------|------------------|------------------|------------------|------------------|-------------------|
| CSF405 | 405mm Square Fascia (D/E) | 5m | 1 | 367.20 | 384.67 | 400.21 | 439.75 | 400.21 | 444.23 | 444.23 | 444.23 | 444.23 |
| CSF300 | 300mm Square Fascia | 5m | 1 | - | - | - | - | 336.45 | 373.46 | - | - | - |
| CSF250 | 250mm Square Fascia | 5m | 2 | 234.59 | 244.80 | 254.96 | 270.26 | 254.96 | 283.00 | - | - | 283.00 |
| CSF225 | 225mm Square Fascia | 5m | 2 | 214.20 | 224.40 | 234.59 | 248.66 | 234.59 | 260.39 | 260.39 | 260.39 | 260.39 |
| CSF200 | 200mm Square Fascia | 5m | 2 | 193.80 | 199.92 | 210.10 | 222.71 | 210.10 | 233.21 | - | 233.21 | 233.31 |
| CSF175 | 175mm Square Fascia | 5m | 2 | 183.58 | 187.69 | 199.92 | 211.92 | 199.92 | 221.91 | 221.91 | 221.91 | 221.91 |
| CSF150 | 150mm Square Fascia | 5m | 2 | 173.39 | 183.58 | 191.75 | 203.25 | 191.75 | 212.84 | 212.84 | 212.84 | 212.84 |

Tudor Board (20mm Flat - no soffit groove)

| | | | | | | | | | | | | |
|--------|-------------------|----|---|--------|--------|--------|---|--------|---|---|---|---|
| JTF150 | 150mm Flat Fascia | 5m | 2 | 218.62 | 229.43 | 251.35 | - | 251.35 | - | - | - | - |
|--------|-------------------|----|---|--------|--------|--------|---|--------|---|---|---|---|

Soffit (9mm Flat)

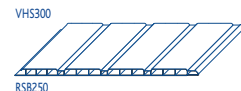
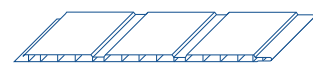

| | | | | | | | | | | | | |
|-------|--------------------|----|---|--------|--------|--------|--------|--------|--------|--------|--------|--------|
| SM405 | 405mm x 9mm Soffit | 5m | 1 | 237.02 | 249.07 | 268.10 | 284.19 | 268.10 | 297.59 | - | 297.59 | 297.59 |
| SM300 | 300mm x 9mm Soffit | 5m | 2 | 177.95 | 186.91 | 197.57 | 209.43 | 197.57 | 219.30 | - | 219.30 | 219.30 |
| SM250 | 250mm x 9mm Soffit | 5m | 2 | - | - | - | - | 174.92 | 194.16 | - | - | - |
| SM225 | 225mm x 9mm Soffit | 5m | 2 | 111.21 | 116.77 | 122.00 | 129.32 | 122.00 | 135.42 | 135.42 | - | - |
| SM200 | 200mm x 9mm Soffit | 5m | 2 | 98.02 | 102.91 | 107.50 | 113.95 | 107.50 | 119.33 | - | 119.33 | 119.33 |
| SM175 | 175mm x 9mm Soffit | 5m | 2 | 84.80 | 88.99 | 93.04 | 98.63 | 93.04 | 103.27 | 103.27 | - | - |
| SM150 | 150mm x 9mm Soffit | 5m | 2 | 73.37 | 77.02 | 80.59 | 85.43 | 80.59 | 89.45 | 89.45 | 89.45 | 89.45 |
| SM100 | 100mm x 9mm Soffit | 5m | 5 | 50.25 | 52.75 | 55.16 | - | 55.16 | - | - | - | - |

Hollow Soffit (9mm Flat)

| | | | | | | | | | | | | |
|--------|-------------------------------|----|----|--------|--------|--------|--------|--------|--------|---|---|--------|
| VHS300 | 300mm Hollow Soffit | 5m | 5 | 175.65 | 175.65 | 175.65 | 184.43 | 175.65 | 184.43 | - | - | 184.43 |
| HST | Hollow Soffit Edge Trim | 5m | 10 | 44.70 | 47.60 | 51.33 | 53.90 | 51.33 | 57.20 | - | - | 57.20 |
| HJT | Hollow Soffit Joint Trim | 5m | 10 | 55.57 | 58.97 | 64.02 | 67.22 | 64.02 | 71.10 | - | - | 71.10 |
| RSB250 | 250mm Hollow Soffit (4 Plank) | 5m | 5 | - | 153.20 | - | - | - | - | - | - | - |

Soffit (9mm Vented)

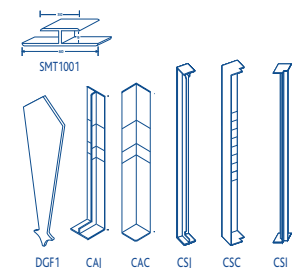

| | | | | | | | | | | | | |
|--------|---------------------|----|---|--------|--------|--------|---|--------|--------|---|---|--------|
| SM405V | 405mm Vented Soffit | 5m | 1 | 357.00 | 374.97 | 398.27 | - | 398.27 | 442.08 | - | - | - |
| SM300V | 300mm Vented Soffit | 5m | 2 | 295.79 | 309.09 | 322.29 | - | 322.29 | 357.74 | - | - | - |
| SM225V | 225mm Vented Soffit | 5m | 2 | 224.40 | 224.40 | 246.82 | - | 246.82 | 273.97 | - | - | 274.02 |
| SM175V | 175mm Vented Soffit | 5m | 2 | 192.74 | 197.87 | 210.10 | - | 210.10 | 233.21 | - | - | - |
| SM150V | 150mm Vented Soffit | 5m | 2 | - | 192.74 | 204.63 | - | 204.63 | 227.14 | - | - | - |

Joints and Corners

| Code | Description | Std Length | Pack Qty | Price Pk (M) (£) | Price Pk (C) (£) | Price Pk (R) (£) | Price Pk (Q) (£) | Price Pk (Z) (£) | Price Pk (X) (£) | Price Pk (K) (£) | Price Pk (D) (£) | Price Pk (AG) (£) |
|---------|------------------------|------------|----------|---------------------|---------------------|---------------------|---------------------|---------------------|---------------------|---------------------|---------------------|----------------------|
| SMT1001 | Soffit Joint | 5m | 2 | 58.48 | 61.96 | 67.22 | 70.73 | 67.22 | 74.61 | 74.61 | 74.61 | 74.61 |
| DGF1 | Gable Finial | 340mm | 5 | 83.81 | 83.81 | 83.81 | - | 83.81 | 93.03 | - | - | - |
| CAJ | Fascia Joint | 300mm | 10 | 142.40 | 142.40 | 163.70 | 173.53 | 163.70 | 181.71 | - | - | 181.71 |
| CAC | 90° Fascia Corner | 300mm | 10 | 151.81 | 151.81 | 174.61 | 185.09 | 174.61 | 193.82 | - | - | 193.82 |
| CSJ | Square Face-Fix Joint | 500mm | 2 | 99.21 | 99.21 | 99.21 | - | 114.13 | 126.68 | 126.68 | 126.68 | 126.68 |
| CSC | 90°Face-Fix Corner | 500mm | 2 | 105.18 | 105.18 | 105.18 | - | 120.97 | 134.28 | 134.28 | 134.28 | 134.28 |
| CSI | Square Internal Corner | 500mm | 2 | 105.18 | 105.18 | 105.18 | - | 120.97 | 134.28 | - | - | - |

M = Mahogany
D = Cream

C = Light Oak
Z = Black

R = Rosewood
Q = Irish Oak
X = Anthracite Grey (RAL 7016)

K = White
AG = Agate Grey

Cladding

Cladding Foiled

| Code | Description | Std Length | Pack Qty | Price (M) (£) | Price (C) (£) | Price (R) (£) | Price (Q) (£) | Price (Z) (£) | Price (X) (£) | Price (K) (£) | Price (D) (£) | Price (AG) (£) |
|-------|------------------------|------------|----------|------------------|------------------|------------------|------------------|------------------|------------------|------------------|------------------|-------------------|
| CS150 | 150mm Shiplap Cladding | 5m | 5 | 122.41 | 134.70 | 134.70 | - | 152.24 | 157.00 | - | - | 157.00 |
| CV100 | 100mm Open V | 5m | 5 | 102.00 | 112.18 | 112.18 | - | 126.83 | 130.80 | - | - | - |

Cladding Trims Foiled

| | | | | | | | | | | | | |
|-------|----------------------------|----|---|-------|-------|-------|---|-------|--------|---|---|--------|
| CT026 | Universal Channel | 5m | 5 | 46.93 | 50.00 | 50.00 | - | 55.44 | 60.20 | - | - | 60.20 |
| CT051 | 2-Part Joint (M)* | 5m | 5 | 61.19 | 65.27 | 65.27 | - | 73.78 | 79.74 | - | - | - |
| CT290 | 2-Part Universal Trim (M)* | 5m | 5 | 40.82 | 47.55 | 47.55 | - | 48.39 | 52.30 | - | - | 52.30 |
| CT293 | 2-Part Corner Trim (F)* | 5m | 5 | 81.59 | 85.68 | 85.68 | - | 96.78 | 104.40 | - | - | 104.40 |

| | | | | | | | | | | | | |
|-------|---------------------------|--|----|-------|-------|-------|---|--------|--------|---|---|--------|
| CJ043 | 150mm Shiplap Joint Cover | | 10 | 91.76 | 96.38 | 96.38 | - | 105.57 | 117.70 | - | - | 117.70 |
| CJ281 | 100mm Open V Joint Cover | | 10 | 88.66 | 93.11 | 93.11 | - | 101.91 | - | - | - | - |

Cladding Trims Plain

| Code | Description | Std Length | Pack Qty | Price (A) (£) | Price (B) (£) | | | | | | | |
|---------|-------------------------|------------|----------|------------------|------------------|---|---|---|---|---|---|---|
| CT027 | Starter Trim (plain) | 5m | 10 | 24.63 | 24.63 | - | - | - | - | - | - | - |
| CT065 | 60 x15mm Vent (plain) | 5m | 5 | 35.60 | 35.60 | - | - | - | - | - | - | - |
| SVT5000 | 25mm Ventilator (plain) | 5m | 5 | 61.85 | - | - | - | - | - | - | - | - |

NOTE: (M)* = Male, (F)* = Female

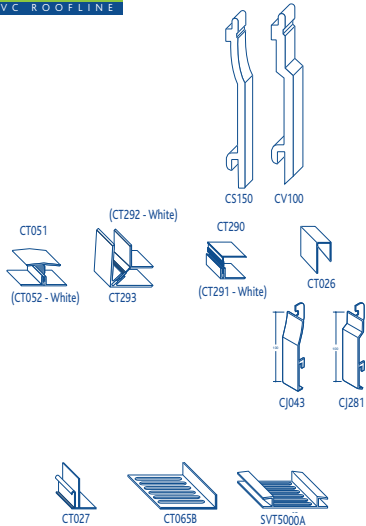

Window Boards & Reveal Liners

| Code | Description | Std Length | Pack Qty | Price (M) (£) | Price (C) (£) | Price (R) (£) | Price (Q) (£) | Price (Z) (£) | Price (X) (£) | Price (K) (£) | Price (D) (£) | Price (AG) (£) |
|--------|------------------------|------------|----------|------------------|------------------|------------------|------------------|------------------|------------------|------------------|------------------|-------------------|
| BNW225 | 225mm B/N Window Board | 5m | 2 | 126.75 | 126.75 | 129.28 | 143.55 | - | - | - | - | - |
| BNW175 | 175mm B/N Window Board | 5m | 2 | 101.40 | 101.40 | 103.43 | - | - | - | - | - | - |

Depth measured externally

| | | | | | | | | | | | | |
|--------|-------------------------|----|---|--------|--------|--------|--------|--------|--------|--------|--------|--------|
| SFN405 | 405mm Cover Board (D/E) | 5m | 1 | 242.18 | 253.01 | 258.07 | 333.96 | 299.19 | 333.96 | 333.96 | 333.96 | 333.96 |
| SFN300 | 300mm Cover Board | 5m | 2 | 181.62 | 187.10 | 190.76 | - | 201.58 | 226.60 | - | - | 226.60 |
| SFN250 | 250mm Cover Board | 5m | 2 | 149.59 | 154.06 | 157.11 | - | 165.16 | 185.66 | - | - | - |
| SFN225 | 225mm Cover Board | 5m | 2 | 124.56 | 128.23 | 130.76 | 143.55 | 135.42 | 152.20 | 152.20 | 152.20 | 152.20 |
| SFN200 | 200mm Cover Board | 5m | 2 | 112.31 | 115.57 | 117.89 | - | 121.42 | 138.78 | - | - | 138.78 |
| SFN175 | 175mm Cover Board | 5m | 2 | 100.06 | 103.06 | 105.11 | 114.71 | 108.22 | 121.60 | 121.60 | 121.60 | 121.60 |
| SFN150 | 150mm Cover Board | 5m | 2 | 93.75 | 96.57 | 98.47 | - | 101.44 | 114.00 | - | - | 114.00 |

End Caps

| Code | Description | Std Length | Pack Qty | Price Pk (M) (£) | Price Pk (C) (£) | Price Pk (R) (£) | Price Pk (Q) (£) | Price Pk (Z) (£) | Price Pk (X) (£) | Price Pk (K) (£) | Price Pk (D) (£) |
|------|------------------------|------------|----------|---------------------|---------------------|---------------------|---------------------|---------------------|---------------------|---------------------|---------------------|
| CEC5 | B/N Window Board E.Cap | 135mm | 5 | 12.30 | 12.30 | - | - | - | - | - | - |
| CEC6 | B/N Window Board E.Cap | 300mm | 10 | 81.85 | 81.85 | 81.85 | 98.37 | - | - | - | - |
| CEC8 | Cover Board End Cap | 50mm | 20 | 25.49 | 25.49 | - | - | - | - | - | - |
| CEC2 | Cover Board End Cap | 300mm | 10 | 77.11 | 77.11 | 77.11 | 92.52 | 77.11 | - | - | - |

A = Black (not foiled) B = Brown (not foiled)* M = Mahogany C = Light Oak R = Rosewood AG = Agate Grey
 Q = Irish Oak K = White D = Cream Z = Black X = Anthracite Grey (RAL 7016)
 * For use with Mahogany & Rosewood profiles

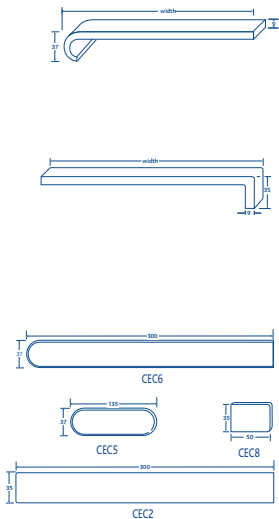

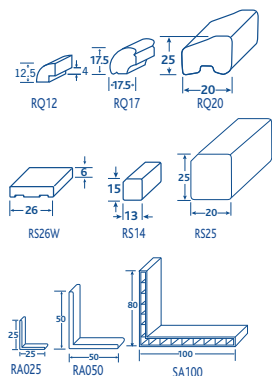

Internal Trims

| Code | Description | Std Length | Pack Qty | Price (M) (£) | Price (C) (£) | Price (R) (£) | Price (Q) (£) | Price (K) (£) | Price (D) (£) | Price (Z) (£) | Price (X) (£) | Price (L) (£) | Price (SX) (£) | Price (U) (£) | Price (O) (£) | Price (I) (£) | Price (AG) (£) | Price (SZ) (£) |
|-------|-------------------------|------------|----------|---------------|---------------|---------------|---------------|---------------|---------------|---------------|---------------|---------------|----------------|---------------|---------------|---------------|----------------|----------------|
| RQ12 | 12mm Quadrant | 5m | 20 | 15.10 | 15.10 | 15.79 | - | 16.58 | - | 15.79 | - | - | - | - | - | - | - | - |
| RQ17 | 17.5mm Quadrant | 5m | 20 | 17.78 | 17.78 | 18.65 | 18.65 | 19.58 | 19.58 | 18.65 | 19.58 | 19.58 | 19.58 | - | - | - | 19.58 | 19.58 |
| RQ18* | 18mm Quadrant | 5m | 10 | - | - | - | - | - | - | - | - | - | - | 19.58 | 19.58 | 19.58 | - | - |
| RQ20 | 20 x 15mm Bead | 5m | 20 | - | 31.10 | 32.65 | - | - | - | - | - | - | - | - | - | - | - | - |
| RS26 | 26 x 6mm Batten | 5m | 25 | - | 21.84 | 23.87 | - | - | - | - | - | - | - | - | - | - | - | - |
| RS14 | 15 x 13mm Rectangle | 5m | 25 | 18.66 | - | - | - | - | - | - | - | - | 20.55 | - | - | - | - | - |
| RS25 | 25 x 20mm Rectangle | 5m | 10 | 60.85 | 60.85 | 63.88 | 63.88 | 67.07 | - | 63.88 | 67.07 | - | - | - | - | - | - | 67.07 |
| RA025 | 25 x 25mm Angle | 5m | 20 | 43.44 | 43.44 | 45.62 | - | - | - | 45.62 | - | - | - | - | - | - | - | - |
| RA050 | 50 x 50mm Angle | 5m | 10 | 73.74 | 73.74 | 77.40 | - | - | - | 77.40 | - | - | - | - | - | - | - | - |
| SA100 | 100 x 80mm Hollow Angle | 5m | 5 | - | 115.63 | 115.63 | - | - | - | 115.63 | - | - | - | - | - | - | - | - |

Skirting & Architraves

7.5mm System

| Code | Description | Std Length | Pack Qty | Price (M) (£) | Price (C) (£) | Price (R) (£) | Price (Q) (£) | Price (K) (£) | Price (D) (£) | Price (Z) (£) | Price (X) (£) | Price (L) (£) | Price (SX) (£) | Price (U) (£) | Price (O) (£) | Price (I) (£) | Price (AG) (£) | Price (SZ) (£) |
|-------|-----------------|------------|----------|---------------|---------------|---------------|---------------|---------------|---------------|---------------|---------------|---------------|----------------|---------------|---------------|---------------|----------------|----------------|
| RP050 | 50mm Architrave | 5m | 10 | 27.11 | - | - | - | - | - | - | - | - | - | - | - | - | - | - |
| RP075 | 75mm Skirting | 5m | 10 | 32.90 | - | - | - | - | - | - | - | - | - | - | - | - | - | - |
| RP100 | 100mm Skirting | 5m | 5 | 44.02 | - | - | - | - | - | - | - | - | - | - | - | - | - | - |

6mm System

| | | | | | | | | | | | | | | | | | | |
|-------|----------------------------|----|----|-------|-------|-------|-------|-------|-------|-------|-------|-------|-------|-------|-------|-------|-------|-------|
| RL025 | 25mm D Section | 5m | 25 | 16.89 | 16.89 | 18.65 | 18.65 | 19.58 | 19.58 | 18.65 | 19.58 | 19.58 | 19.58 | - | - | - | 19.58 | 19.58 |
| RD028 | 28mm D Section (flat back) | 5m | 10 | - | - | - | - | - | - | - | - | - | - | 19.58 | 19.58 | 19.58 | - | - |
| RE028 | 28mm Edge Trim | 5m | 10 | - | 23.00 | 24.15 | - | - | - | - | - | - | - | 27.36 | 27.36 | 27.36 | - | - |
| RL020 | 20mm Edge Section | 5m | 25 | 16.42 | 16.42 | 17.28 | 17.28 | 19.58 | - | 17.28 | 19.58 | 19.58 | 19.58 | - | - | - | 19.58 | 19.58 |
| RT045 | 45mm Architrave | 5m | 10 | 24.47 | 24.47 | 25.64 | 25.64 | 26.92 | 26.92 | 25.64 | 26.92 | 26.92 | 26.92 | - | - | - | 26.92 | 26.92 |
| RT070 | 70mm Skirting | 5m | 10 | 30.64 | 30.64 | 32.25 | 32.25 | 33.86 | 33.86 | 32.25 | 33.86 | 33.86 | 33.86 | - | - | - | 33.86 | 33.86 |
| RT095 | 95mm Skirting | 5m | 5 | 42.25 | 42.25 | 44.38 | 44.38 | 46.60 | 46.60 | 44.38 | 46.60 | 46.60 | 46.60 | - | - | - | 46.60 | 46.60 |

5.5mm System

| | | | | | | | | | | | | | | | | | | |
|-------|-----------------|----|---|---|---|---|---|---|---|---|---|---|---|-------|-------|-------|---|---|
| RK045 | 45mm Architrave | 5m | 4 | - | - | - | - | - | - | - | - | - | - | 26.92 | 26.92 | 26.92 | - | - |
| RK065 | 65mm Skirting | 5m | 4 | - | - | - | - | - | - | - | - | - | - | 33.86 | 33.86 | 33.86 | - | - |
| RK095 | 95mm Skirting | 5m | 4 | - | - | - | - | - | - | - | - | - | - | 46.60 | 46.60 | 46.60 | - | - |

* Not Illustrated

M = Mahogany C = Light Oak R = Rosewood Q = Irish Oak K = White D = Cream Z = Black X = Anthracite Grey (RAL 7016) L = Chartwell Green SX = Anthracite Grey (Smooth)
 U = Sage O = Claystone I = Pebble Grey AG = Agate Grey SZ = Black Smooth

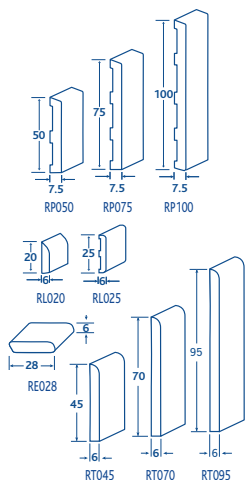

Plaslyne Angles

| Code | Description | Std Length | Pack Qty | Price (WG) (£) | Price (LO) (£) | Price (RW) (£) | Price (BA) (£) | Price (X) (£) |
|----------|-----------------------|------------|----------|----------------|----------------|----------------|----------------|---------------|
| PSA25x25 | 25 x 25mm Solid Angle | 5m | 20 | - | 16.10 | 16.10 | 16.10 | 19.32 |
| PSA32x32 | 32 x 32mm Solid Angle | 5m | 10 | 18.68 | 18.68 | 18.68 | 18.68 | - |
| PSA50x50 | 50 x 50mm Solid Angle | 5m | 10 | - | 46.96 | 46.96 | 46.96 | 54.00 |

WG = Mahogany LO = Light Oak RW = Rosewood BA = Black Ash X = Anthracite Grey (RAL 7016) SZ = Black Smooth



Plaslyne Cills and Ancillaries

Standard Cills (60mm System)

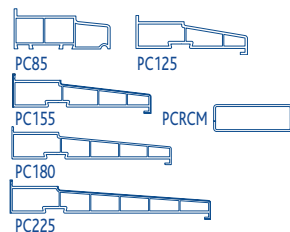

| Code | Description | Std Length | Pack Qty | Price/Lgth (£) (B) | Price/Lgth (£) (WG) | Price/Lgth (£) (LO) | Price/Lgth (£) (RW) | Price/Lgth (£) (BR) | Price/Lgth (£) (BA) | Price/Lgth (£) (BL) |
|-------|------------------------|------------|----------|-----------------------|------------------------|------------------------|------------------------|------------------------|------------------------|------------------------|
| PC85 | 85mm Standard Cill | 5m | 2 | 18.40 | - | 35.50 | 35.50 | - | - | - |
| PC125 | 125mm Standard Cill | 5m | 2 | 30.00 | - | 51.70 | 51.70 | - | - | - |
| PC155 | 155mm Standard Cill | 5m | 2 | 31.64 | - | 57.00 | 57.00 | - | 57.00 | - |
| PC180 | 180mm Standard Cill | 5m | 2 | 36.20 | - | 75.00 | 75.00 | - | - | - |
| PC225 | 225mm Standard Cill | 5m | 2 | 44.00 | - | 107.00 | 107.00 | - | - | - |
| PCRCM | Standard Reinforcement | 5m | 1 | 14.52 | - | - | - | - | - | - |

Ancillaries for Standard Cills (60mm System)



| Code | Description | Std Length | Pack Qty | Price/Lgth (£) (B) | Price/Lgth (£) (WG) | Price/Lgth (£) (LO) | Price/Lgth (£) (RW) | Price/Lgth (£) (BR) | Price/Lgth (£) (BA) | Price/Lgth (£) (BL) |
|-----------|------------------------|------------|----------|-----------------------|------------------------|------------------------|------------------------|------------------------|------------------------|------------------------|
| PC85*CAP | End Cap 85mm (Plain) | - | Box 100 | 13.86 | - | 13.86 | - | - | - | - |
| PC125*CAP | End Cap 125mm (Plain) | - | Box 100 | 22.11 | 22.11 | - | - | - | - | - |
| PC155*CAP | End Cap 155mm (Plain) | - | Box 100 | 22.11 | 22.11 | 22.11 | - | - | 22.11 | - |
| PC180*CAP | End Cap 180mm (Plain) | - | Box 100 | 28.54 | - | 28.54 | - | - | - | - |
| PC225*CAP | End Cap 225mm (Foiled) | - | Box 50 | 34.66 | - | 200.00 | 200.00 | - | - | - |

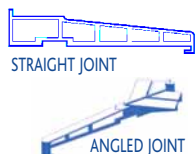

| Code | Description | Std Length | Pack Qty | Price/Lgth (£) (W) | Price/Lgth (£) (WG) | Price/Lgth (£) (LO) | Price/Lgth (£) (RW) | Price/Lgth (£) (BR) | Price/Lgth (£) (BA) | Price/Lgth (£) (BL) |
|---------|--------------------------------|------------|----------|-----------------------|------------------------|------------------------|------------------------|------------------------|------------------------|------------------------|
| PCJ155 | Straight Joint 155mm (1) Plain | - | Pack 10 | 26.00 | - | 26.00 | - | - | - | - |
| PCJ180 | Straight Joint 180mm (2) Plain | - | Pack 10 | 26.00 | - | - | - | 26.00 | - | - |
| P155135 | Angled Joint 135° (3) Plain | - | Pack 10 | 26.00 | - | - | - | 26.00 | - | - |
| P15590 | Angled Joint 90° (3) Plain | - | Pack 10 | 26.00 | - | 26.00 | - | 26.00 | - | - |

Large Platform Cills (70mm System)

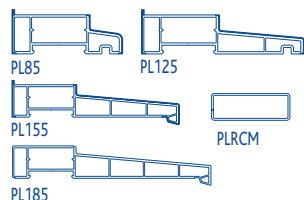

| Code | Description | Std Length | Pack Qty | Price/Lgth (£) (B) | Price/Lgth (£) (WG) | Price/Lgth (£) (LO) | Price/Lgth (£) (RW) | Price/Lgth (£) (BR) | Price/Lgth (£) (BA) | Price/Lgth (£) (BL) |
|-------|------------------------------|------------|----------|-----------------------|------------------------|------------------------|------------------------|------------------------|------------------------|------------------------|
| PL85 | 85mm Large Platform Cill | 5m | 2 | 16.12 | 35.15 | 35.15 | 35.15 | - | - | - |
| PL125 | 125mm Large Platform Cill | 5m | 2 | 30.03 | - | - | - | - | - | - |
| PL155 | 155mm Large Platform Cill | 5m | 2 | 30.23 | 50.00 | 50.00 | 50.00 | - | - | - |
| PL185 | 185mm Large Platform Cill | 5m | 2 | 31.60 | - | 66.05 | 66.05 | - | - | - |
| PLRCM | Large Platform Reinforcement | 5m | 1 | 9.32 | - | - | - | - | - | - |

Large Platform Cills (70mm System) Extended Colour Range

| Code | Description | Std Length | Pack Qty | Price/Lgth (£) (WGW) | Price/Lgth (£) (LOW) | Price/Lgth (£) (RWW) | Price/Lgth (£) (BAW) |
|-------|---------------------------|------------|----------|-------------------------|-------------------------|-------------------------|-------------------------|
| PL85 | 85mm Large Platform Cill | 5m | 2 | - | 35.15 | 35.15 | - |
| PL155 | 155mm Large Platform Cill | 5m | 2 | 50.00 | 50.00 | 50.00 | 50.00 |
| PL185 | 185mm Large Platform Cill | 5m | 2 | - | - | - | 66.05 |

Ancillaries for Large Platform Cills (70mm System)

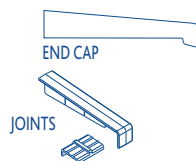

| Code | Description | Std Length | Pack Qty | Price/Lgth (£) (B) | Price/Lgth (£) (WG) | Price/Lgth (£) (LO) | Price/Lgth (£) (RW) | Price/Lgth (£) (BR) | Price/Lgth (£) (BA) | Price/Lgth (£) (BL) |
|----------|-----------------------------------|------------|----------|-----------------------|------------------------|------------------------|------------------------|------------------------|------------------------|------------------------|
| PL85*CAP | End Cap 85mm (Plain) | - | Box 100 | 27.60 | 27.60 | 27.60 | - | - | - | - |
| PL*CAP | Universal End Cap | - | Box 50 | 25.24 | 25.24 | 25.24 | - | - | - | 25.24 |
| PLCJ | Straight Joint (Plain) | - | Pack 10 | 32.80 | 32.80 | 32.80 | - | - | - | - |
| PLCJ90 | Straight Joint 90° (Plain) | - | Pack 10 | 34.40 | 34.40 | 34.40 | - | - | - | - |
| PLCJU | Universal Joint 120°-150° (Plain) | - | Pack 10 | 34.40 | 34.40 | 34.40 | - | - | - | - |

Ancillary Profiles



| | | | | |
|---------|------------------|----|---------|----------|
| PDB | Drip Bar | 5m | 10 | 8.00 ea |
| PDBBCAP | Drip Bar End Cap | - | Box 100 | 21.20 pk |

(1) Cut to fit 85 & 125 (2) Cut to fit 85, 125 & 155
(3) Suitable for all 155mm cills

W = White B = Brilliant White WG = Mahogany LO = Light Oak RW = Rosewood BA = Black Ash BR = Brown BL = Black
"W" added to the code denotes the foil colour on a white base

Important Information

Access Systems

SAFETY FIRST!
Never attempt to access the work area with an unsupported ladder or without a stable deck. Always use a full scaffold platform or a purpose made cantilevered deck system with guard rails in place.

Health and Safety

Full health and Safety information is available on request.

Storage & Handling

Load and unload by hand and support both ends of a 5m length when handling. Stack no higher than 1m, in packing sleeve on a flat base. Avoid contact with solvents, paint, creosote, bitumen etc.

Cutting/Shaping

Use conventional carpentry tools including fine toothed saws. Power tools may be run at speeds appropriate for timber. Nail and screw holes do not require pre-drilling.

Fascia Boards

All Concord 20mm/16mm boards and foiled boards are able to support the weight of the lower row of tiles without the need for a tilt fillet or kick plate.

Fixings

A4 grade stainless steel plastic headed nails or capped screws

| | Fixing | Code | Size | Qty | Max Centres |
|---------------------|--------|------|------|-----|---|
| Roofline | | | | | |
| 16mm Fascia | Nail | C083 | 65mm | 2 | White 600mm Foiled 400mm Coloured 400mm |
| | Screw | C072 | 50mm | 2 | |
| 9mm Cover Boards | Nail | C082 | 50mm | 2 | |
| | Screw | C071 | 40mm | 2 | |
| Flat Boards | Nail | C081 | 40mm | 2 | |
| | Screw | C071 | 40mm | 2 | |
| Cladding | | | | | |
| White* | Nail | C204 | 30mm | 1 | 600mm to 2 storeys 400mm 3 - 5 storeys |
| 600mm to 2 storeys | | | | | |
| 400mm 3 - 5 storeys | | | | | |
| Foiled* | Nail | C204 | 30mm | 1 | 400mm |

* Ensure plank ends are always nailed and that adequate ventilation is provided behind all foiled cladding installations (see reverse of Foiled Product Guarantee for details)

Expansion Gaps

Always leave a minimum 4mm expansion gap at the end of each board, ie where two boards meet leave 8mm overall.

Sealants

Use a low modulus silicone (BS 5889 Type A). Use a primer when bonding to GRP, stainless steel, aluminium or untreated wood. Do not use with polycarbonate sheet.

Asbestos

By law all asbestos materials must be removed by trained operatives under strictly controlled conditions. If you suspect that asbestos is present you should consult your Local Authority.

Ventilation

IMPORTANT - Roof voids must be ventilated in order to stop warm air condensing on cold surfaces. Condensation encourages rot and mould growth.

Foiled cladding installations can suffer from expansion and contraction due to heat absorption, therefore it is important to provide a free air path between vertical battens. Continuity of this ventilation path can be achieved by venting into the eaves or by leaving a 10mm air gap between the cladding and soffit.

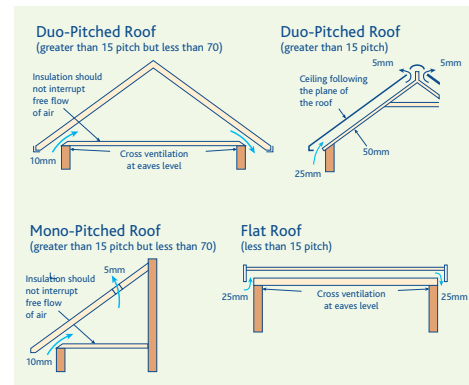

Preparation Checklist

- Use proper access equipment (p22).
- Inspect for asbestos (p22).
- Push back the lower rows of tiles.
- Remove enough gutter, fascia, and soffit for one day's work only.
- Inspect rafters/laths and replace rotted timbers.
- Set up fixing points at maximum centres: white 600mm, coloured/foiled 400mm.
- Make sure ventilation is sufficient (p22).

- E. Nail fascia board to rafter feet (check fixings p22) with sufficient height to create tile kick.
- F. Make soffit and fascia joints between rafters.
- G. Fit a dpc material under the existing felt. New material must dress into the gutter.
- H. Fit gutter brackets directly to replacement fascias of 16mm and above, in accordance with manufacturer's recommendations. Ensure correct fall in the gutter towards the down pipe.
- I. Box end construction. See p24.

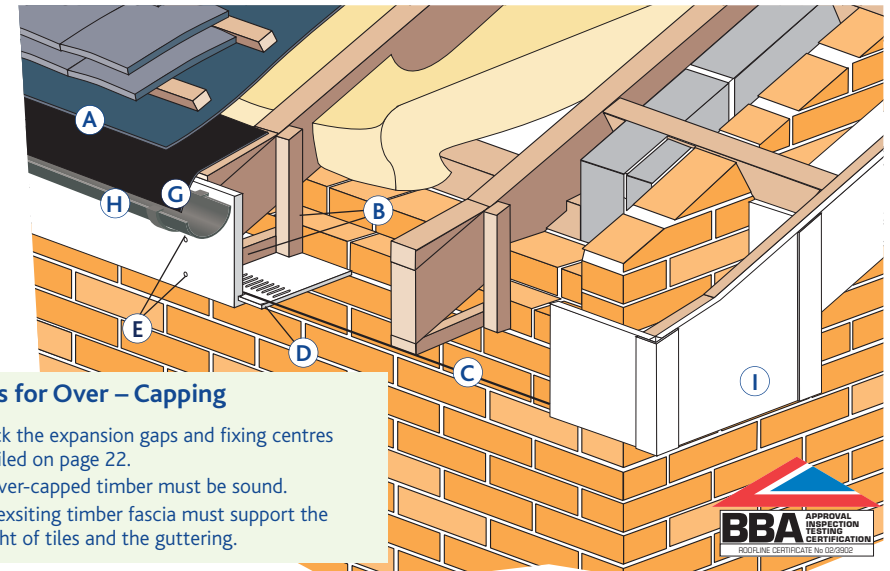

Notes for Over – Capping

1. Check the expansion gaps and fixing centres detailed on page 22.
2. All over-capped timber must be sound.
3. The existing timber fascia must support the weight of tiles and the guttering.

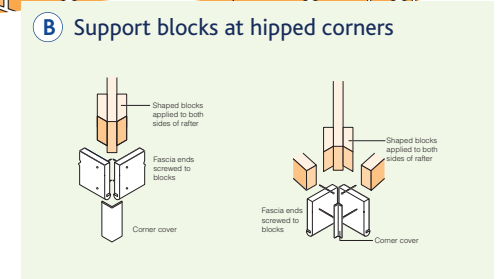
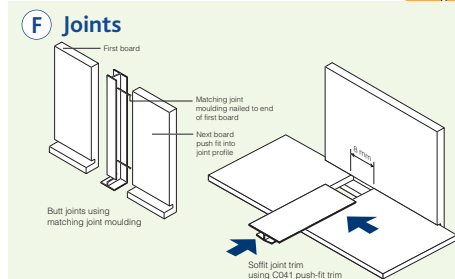

Box End Construction

- A. Finish fascia level with the face of the rafter gable. Soffit should over hang by 10mm and may be cut square or mitred.

Note: Timber hangers should be installed as required to locate box end structure.

- B. Measure and cut box end from a deep board. Front edge should tilt up to match height of fascia board.
 C. Measure and cut fascia to form the return to gable wall.
 D. Remove section from corner joint to fit around rafter.
 E. Fix bargeboard directly to gable rafter.

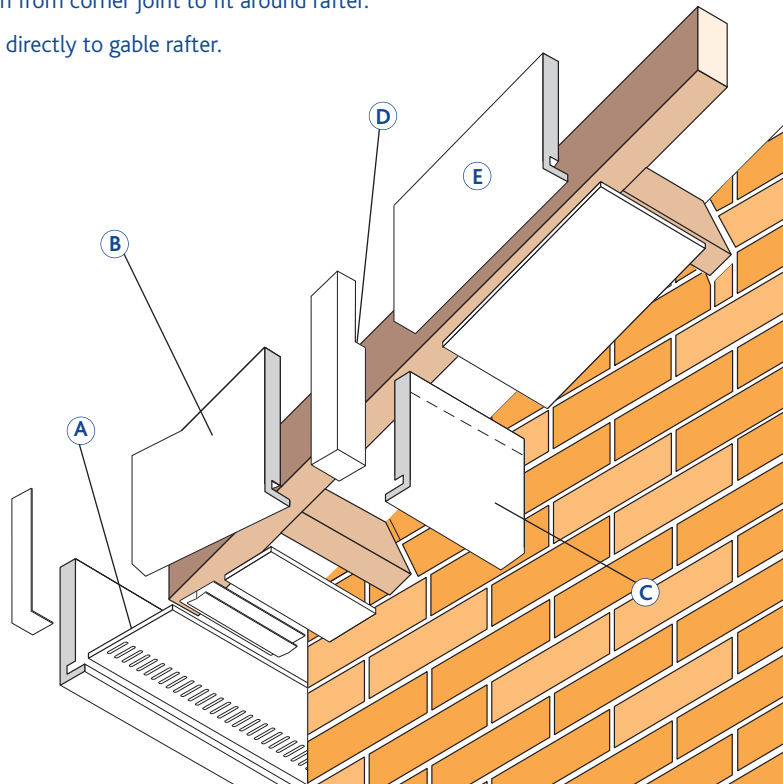

Box End Construction Options

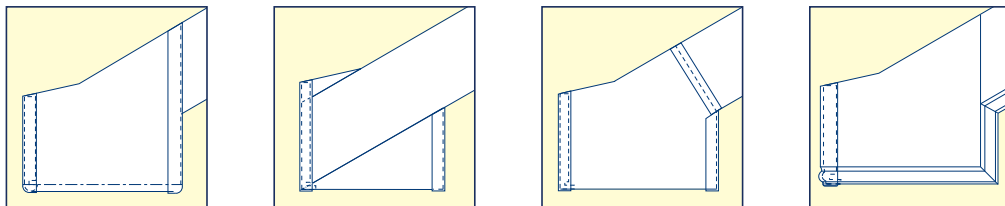

Window Boards & Trims

General

- Fix to dry, sound timber or masonry with a general purpose adhesive, where necessary, using stainless steel plastic headed screws or nails.
- Do not fix to damp surfaces. If there is any risk of damp after fixing, use a low modulus silicone.
- Rotten or damaged timber should be replaced before over capping. On irregular surfaces use packing pieces where needed.

- A. Window board; choice of:
 16mm Bullnose (replacement unit)
 9mm Bullnose Window Board (capping)
 9mm Reveal/Cover Board (capping)
- B. End cap, cut to suit
- C. Choice of Trims (See P11)
 12mm Quadrant featured RQ12 (P11)
- D. 9mm Reveal Liner (Flat Board or Cover Board) (P4 and 7)
- E. Architrave Trims (See P11)
- F. Skirting Profiles (See P11)

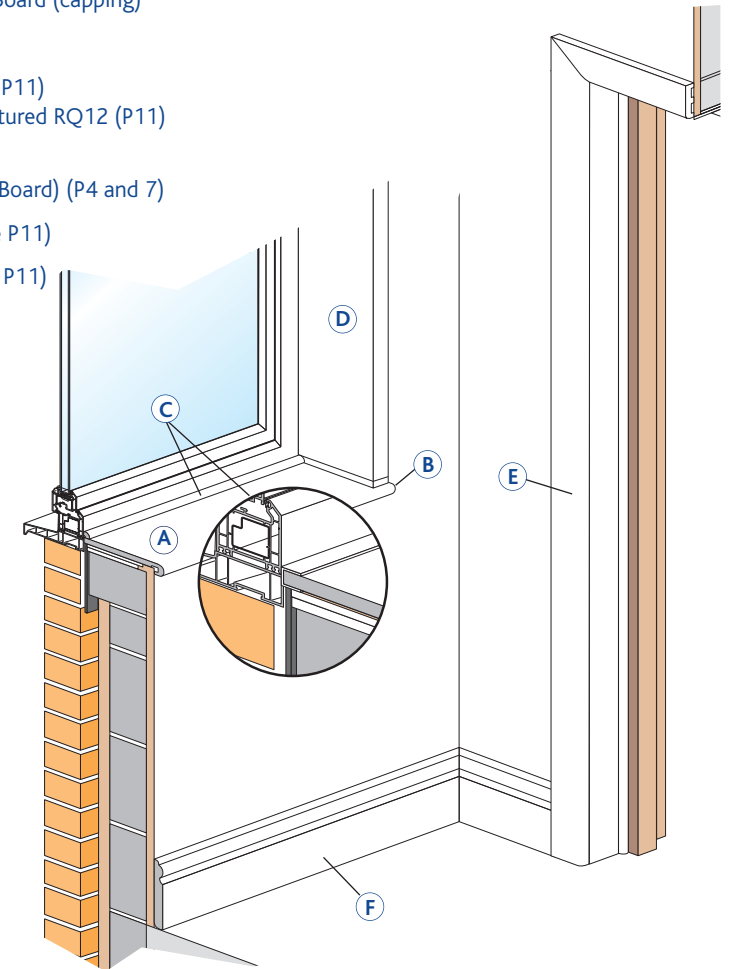

Cladding Installation – Sequence of Work

- A. Perimeter frame battens (recommended 25 x 38mm)
- B. Battens around openings.
- C. Intermediate vertical battens.
- D. Starter trims (or bottom angle ventilation strip, as appropriate, see inset illustrations).
- E. Vertical perimeter trims, corner trims (where two-part trims are used, fix only the inner part).
- F. Top perimeter trims (These engage inside the vertical trims).
- G. Packings to battens as required for any cut planks.
- H. Plank profiles and joint covers or centre joint trims as appropriate (see p 9).
- I. Outer components of two-part trims.

Note: For maximum fixing centres see p 22.

Recommended min. batten depth to create ventilation path behind cladding panels: White cladding = 25mm
Coloured cladding = 50mm

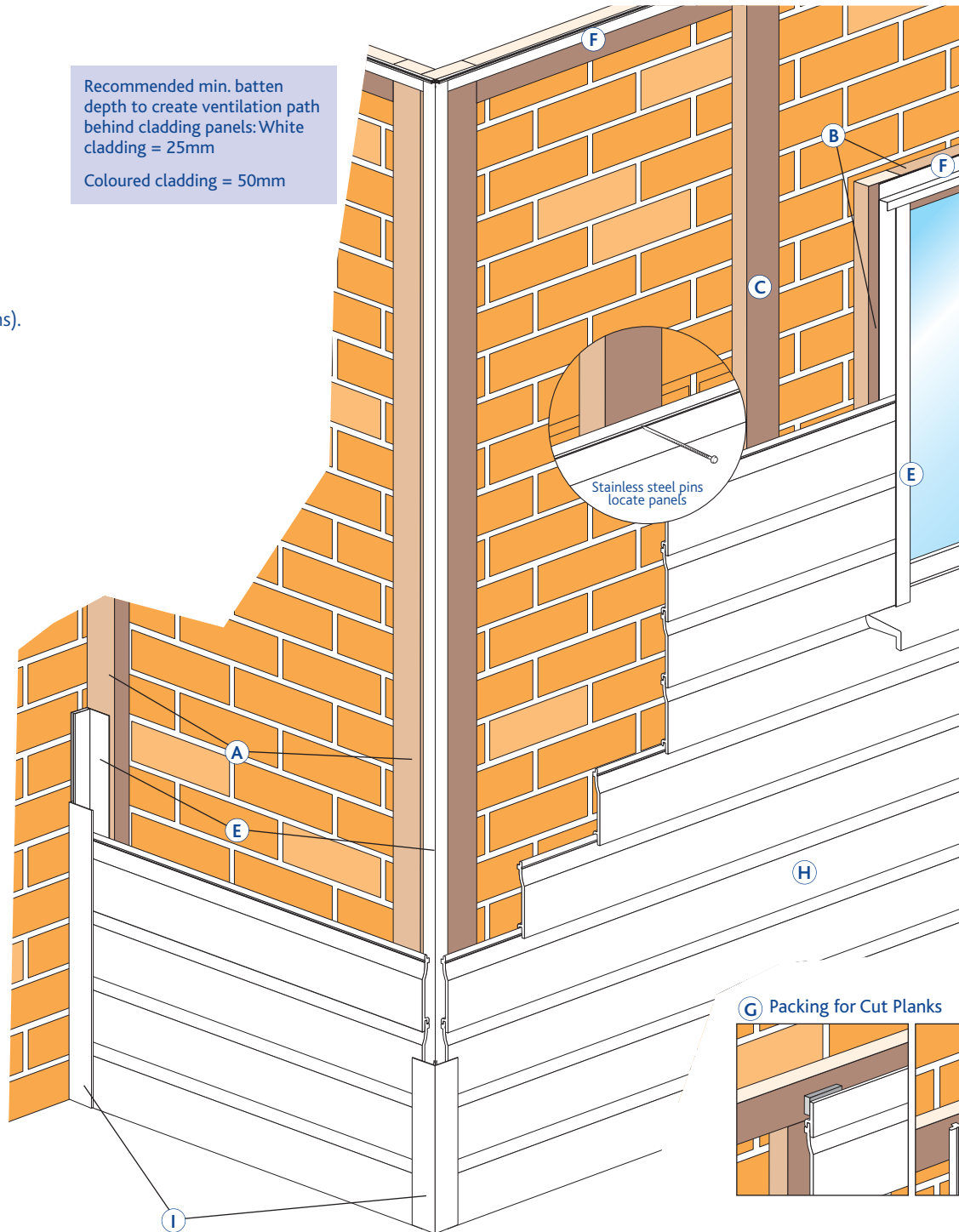

Starter Trims

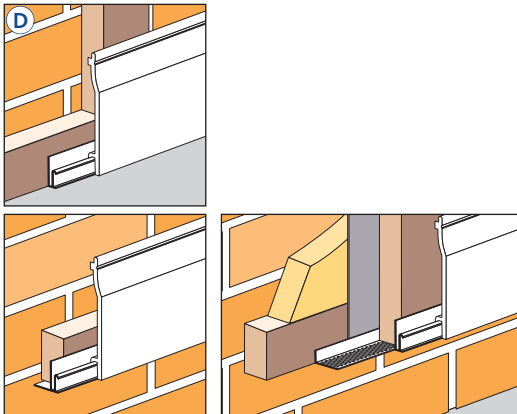

E Trim Options

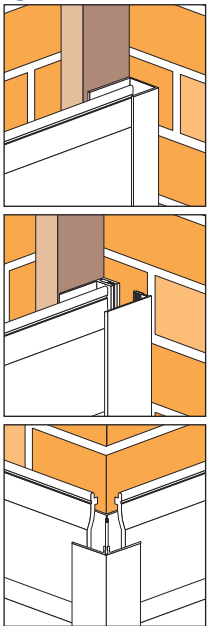

H Joint Options

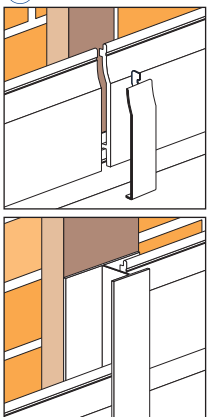

G Packing for Cut Planks

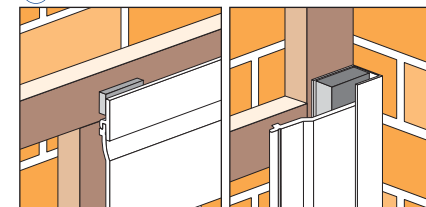



The information contained in this price list is correct at time of publication. Changes will be made from time to time, therefore, purchasers should verify whether changes have taken place since the issue of this price list.



Your Local Concord Stockist

Pioneer House, Mariner, Lichfield Road Ind. Estate,
Tamworth, Staffordshire, B79 7TF
t: (01827) 317230 f: (01827) 316169
www.concordpvc.co.uk