

OX[®]



OX[®]

OUR STORY

OX Tools is a world leading manufacturer of hand tools, diamond tools, workwear and safety products.

Founded in Australia in 1974 OX is recognised as tough, dynamic and different across the globe.

As a manufacturer of professional tools, we sell direct to the merchants, providing them with excellent service, innovative merchandising solutions and an award-winning brand.

Our global online presence and unique Tuff Club membership programme provides a community of tradespeople benefitting from shared experience and knowledge embedding our 'live the trade' attitude into the fabric of building sites around the globe.

FEEL THE POWER OF THE OX.



Issue date: December 2023.

Version 29

Subject to availability and OX Tools UK, terms & conditions of sale.

All prices exclude VAT, E & OE.

	MEASURING TOOLS	06-08
	LAYOUT TOOLS	09-20
	WOODWORKING TOOLS	21-26
	CUTTING TOOLS	27-34
	BRICKLAYING TOOLS	35-41
	PLASTERING & DRY LINING TOOLS	42-50
	ULTIMATE PLASTERING TOOLS	51-55
	CONCRETING TOOLS	56-61
	TILING TOOLS	62-67
	STRIKING TOOLS & DEMOLITION TOOLS	68-76
	PLUMBING & ELECTRICAL TOOLS	77-86
	SITE TOOLS & ACCESSORIES	87-99
TOOLTREK	TOOLTREK	100-102
	TOOL STORAGE	103-109
	TCT BLADES	110-118
	DIAMOND BLADES	119-138
	DRY CORE DRILLS	139-151
	SAFETY/PPE	152-167
	WORKWEAR	168-180



TOUGH

All our products are built to the highest standards using quality raw materials to cope with the demands and rigour of the job site.



DYNAMIC

We utilise our network of established trade professionals to cultivate product feedback that allows us to respond dynamically to the needs of the tradesperson.



DIFFERENT

By living the trade we develop intelligent solutions to create products that improve efficiency on site.



visit [oxtools.com](https://www.oxtools.com) to find out more

OX ENERGY DRINK – 250ML

The OX energy drink gives you all the energy you need for a long day on-site. Put the power in your day!

Product Code	Size	Order Qty	Box Qty	List Price
OX-ED1	250ml	24	24	£1.22



24
BOX

SECTION 01

MEASURING TOOLS

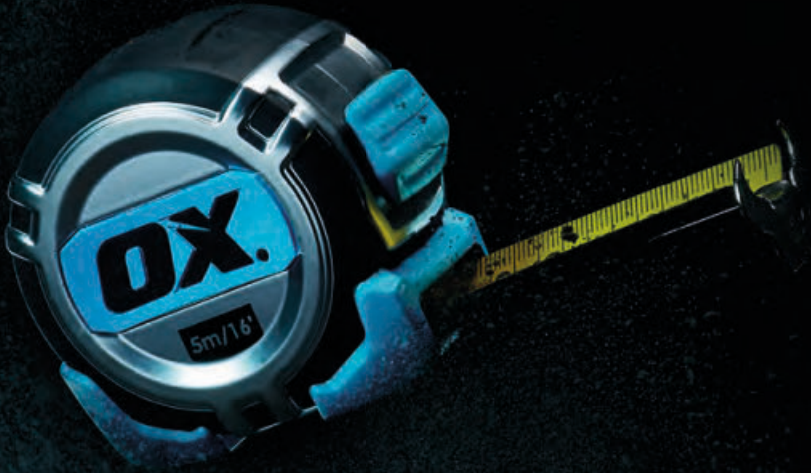



PRO HEAVY DUTY TAPE MEASURE 5M & 8M

FEATURES

- Extra tough nylon coated 32mm wide blade – 2.8M stand out
- Class II & CE approved
- Heavy duty construction
- Easy slide thumb lock



CHECK OUT THE YOUTUBE TUTORIAL HERE

Product Code	Size	Order Qty	Box Qty	List Price
OX-P028905	5m metric only	1	6	£22.00
OX-P028705	5m/16ft	1	6	£22.00
OX-P028708	8m/26ft	1	6	£28.20



PRO TAPE MEASURE 5M & 8M

FEATURES

- Chrome case with over mould for heavy duty use
- Cushion grip for comfort and slip resistant hold
- Extra tough nylon coated steel 27mm wide blade
- 2.8M Stand out
- Big end hook & easy access thumb lock
- Magnetic end hook
- Class II & CE Approved

Product Code	Size	Order Qty	Box Qty	List Price
OX-P020905	5m/16ft	1	8	£17.50
OX-P020908	8m/26ft	1	8	£25.00



PRO DUAL AUTO LOCK TAPE MEASURE 3M, 5M & 8M

FEATURES

- Double-sided tape measurements
- Patented dual locking mechanism
- Robust rubber casing to withstand knocks and drops
- Super compact ergonomic shell
- Handy belt clip for quick clip to tool belt
- Extruded nylon blade for longer life and greater stand out
- Magnetic end hook
- Class II Accuracy



CHECK OUT THE YOUTUBE TUTORIAL HERE

Product Code	Size	Order Qty	Box Qty	List Price
OX-P505203	3m/10ft	1	12	£4.80
OX-P505205	5m/16ft	1	6	£7.21
OX-P505208	8m/ 26ft	1	6	£12.07
OX-P505455	Twinpack 5m/16ft	1	4	£10.58
OX-P505488	Twinpack 8m/26ft	1	4	£18.50



TRADE TAPE MEASURE 3M, 5M & 8M

FEATURES

- Duragrip moulded rubber case
- Nylon coated steel 25mm wide blade
- Easy access sliding thumb lock
- Shock absorbing blade return bumper
- Quick release bottom strip
- Class II Accuracy

Product Code	Size	Order Qty	Box Qty	List Price
OX-T020605	5m/16ft	1	12	£4.11
OX-T020608	8m/26ft	1	12	£6.01
OX-T029103	3m metric only	1	12	£3.03
OX-T029105	5m metric only	1	12	£4.11
OX-T029108	8m metric only	1	12	£6.01



TRADE TAPE MEASURE 10M

FEATURES

- Duragrip moulded rubber case
- Nylon coated steel blade
- Easy access sliding thumb lock
- Shock absorbing blade return bumper
- Quick release bottom strip
- 25mm wide blade
- Class II Accuracy

Product Code	Size	Order Qty	Box Qty	List Price
OX-T500810	10m	1	6	£11.51



PRO CLOSED REEL TAPE MEASURE 30M

FEATURES

- Professional 3:1 geared closed reel
- Shock & impact proof rubber casing
- Double nylon coated fibreglass blade

Product Code	Size	Order Qty	Box Qty	List Price
OX-P028330	30m/100ft	1	6	£38.74



PRO OPEN REEL TAPE MEASURE 30M & 50M

FEATURES

- Professional 3:1 geared open reel tape
- Ergonomic soft grip handle and heavy duty casing
- Double nylon coated fibreglass blade

Product Code	Size	Order Qty	Box Qty	List Price
OX-P028230	30m/100ft	1	1	£41.67
OX-P028250	50m/165ft	1	1	£57.19



TRADE CLOSED REEL TAPE MEASURE 30M

FEATURES

- Durable fibreglass tape
- Quick winding mechanism
- Hi-impact ABS plastic case
- 13mm wide blade

Product Code	Size	Order Qty	Box Qty	List Price
OX-T023603	30m/100ft	1	5	£23.25



TRADE OPEN REEL TAPE MEASURE 30M, 50M & 100M

FEATURES

- Durable fibreglass tape
- Rubber grip handle
- Hi-impact case
- 13mm wide blade

Product Code	Size	Order Qty	Box Qty	List Price
OX-T023503	30m/100ft	1	5	£21.70
OX-T023505	50m/165ft	1	5	£34.09
OX-T023510	100m/330ft	1	5	£58.87

SECTION 02

LAYOUT TOOLS



PRO TUFF LEVEL

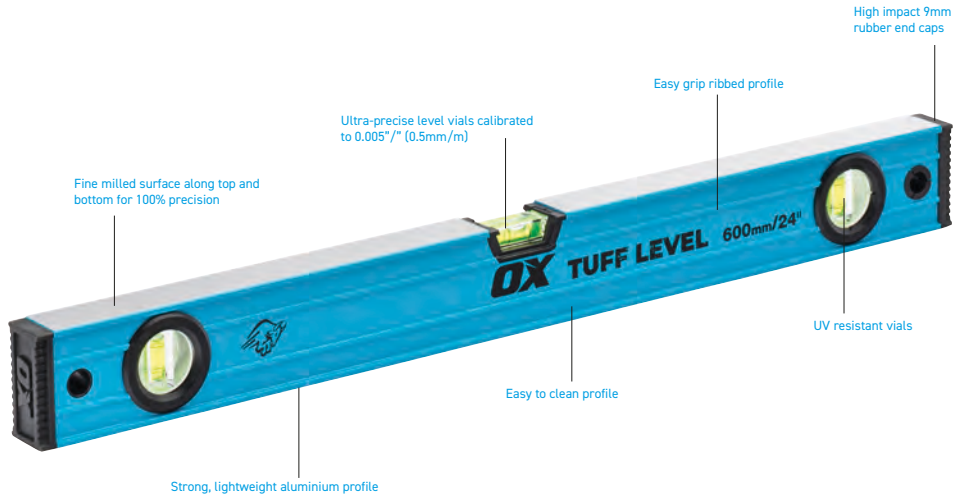

Product Code	Size	Order Qty	Box Qty	List Price
OX-P503406	600mm	1	4	£40.13
OX-P503412	1200mm	1	4	£53.49
OX-P503418	1800mm	1	4	£84.95
OX-P503420	2000mm	1	4	£94.95



PRO LEVEL VARIOUS SIZES

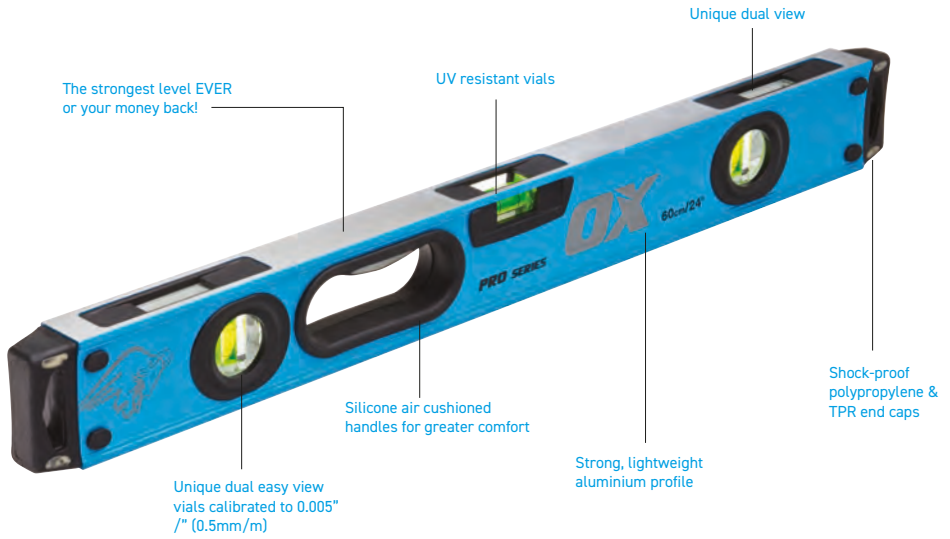

Product Code	Size	Order Qty	Box Qty	List Price
OX-P024406	600mm	1	4	£50.86
OX-P024409	900mm	1	4	£62.84
OX-P024412	1200mm	1	4	£68.75
OX-P024418	1800mm	1	4	£98.12
OX-P024420	2000mm	1	4	£136.19



CHECK OUT THE YOUTUBE TUTORIAL HERE



PRO LEVEL SET

FEATURES

- Set includes 600mm, 1200mm & 1800mm levels and 3 pocket zipped bag
- Lifetime vial warranty
- Unique dual easy view vials calibrated to 0.005" /" (0.5mm/m)
- Precision painted vial level indicators
- Strong, lightweight aluminium profile
- UV resistant vials
- Fine milled surface along top and bottom for 100% precision
- Silicone air cushioned handles for greater comfort
- Magnified vial for better readability
- Shock-proof polypropylene & TPR end caps
- Continuous bridge over central vial to allow accurate draw or score lines
- Rubber studs on faces of the level ensure grip when pressed against surfaces



Product Code	Size	Order Qty	Box Qty	List Price
OX-P028603	see above	1	4	£225.00

PRO LEVEL BAG*

FEATURES

- Tough construction for ultimate durability
- Strong grip handle and shoulder strap
- Holds 600, 1200 & 1800mm levels (not included)
- 3 Zipped cases



Product Code	Size	Order Qty	Box Qty	List Price
OX-P027501	see above	1	4	£37.50

*PRO LEVEL BAG ONLY

PRO LEVEL WITH STEEL RULE

FEATURES

- Unique 12mm Level with integrated measuring and marking solution
- Life time warranty on all vials which are individually calibrated to an accuracy of .5"/" (.5mm/m) or .29"
- Removeable shock-proof polypropylene end caps
- Integrated steel ruler
- Milled base

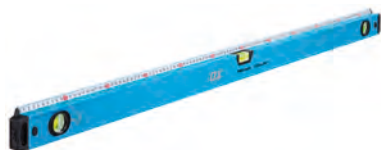

Product Code	Size	Order Qty	Box Qty	List Price
OX-P029012	1200mm	1	4	£45.00

TRADE LEVEL SET 4 PACK

FEATURES

- Includes 600mm, 1200mm & 1800mm trade levels & trade 230mm torpedo level (OX-T026323)
- Lifetime vial warranty
- 3 solid acrylic vials with accuracy of .5mm/m or .0005in/in
- UV resistant vials
- Milled surface on base up to 1200mm length
- Shock absorbing rubber end caps
- Strong, lightweight aluminium profile
- Tough rubber end caps



Product Code	Size	Order Qty	Box Qty	List Price
OX-T500404	see above	1	4	£84.00

TRADE LEVEL VARIOUS SIZES

FEATURES

- Lifetime vial warranty
- 3 solid acrylic vials with accuracy of .5mm/m or .0005in/in
- UV resistant vials
- Milled surface on base up to 1200mm length
- Shock absorbing rubber end caps
- Strong, lightweight aluminium profile
- Tough rubber end caps



Product Code	Size	Order Qty	Box Qty	List Price
OX-T500206	600mm	1	4	£25.00
OX-T500209	900mm	1	4	£30.00
OX-T500212	1200mm	1	4	£35.00
OX-T500218	1800mm	1	4	£47.50

PRO HEAVY DUTY TORPEDO LEVEL

FEATURES

- Tilted horizontal vial for direct view of bubble
- 3 Unbreakable acrylic shock-proof vials
- Accuracy <math>0.0005"/math> (0.5mm/m)
- 25mm Thick profile – extremely strong construction
- Rare earth magnets for strong grip to metal surface
- Fine milled surface with V-groove



CHECK OUT THE YOUTUBE TUTORIAL HERE



Product Code	Size	Order Qty	Box Qty	List Price
OX-P027210	250mm/10"	1	4	£52.18

PRO TORPEDO LEVEL

FEATURES

- Die-cast aluminium body
- 3 Unbreakable acrylic shock-proof vials
- Accuracy <math>0.0005"/math> (0.5mm/m)
- Rare earth magnets for strong grip to metal surface
- Fine milled surface with V-groove



CHECK OUT THE YOUTUBE TUTORIAL HERE



Product Code	Size	Order Qty	Box Qty	List Price
OX-P027625	230mm/9"	1	10	£18.69

TRADE TORPEDO LEVEL 230MM

FEATURES

- 3 easy to read vials (horizontal, vertical, 45 degrees)
- Magnetic V-groove for pipe work and scaffolding
- Tough rubber end caps



Product Code	Size	Order Qty	Box Qty	List Price
OX-T026323	230mm	1	20	£11.17

TRADE STUBBY LEVEL 100MM

FEATURES

- Shockproof solid acrylic vial
- Lightweight aluminium box profile fits easily into your tool belt or pocket
- Accuracy: <math>0.5mm/m (0.0005"/math>)



Product Code	Size	Order Qty	Box Qty	List Price
OX-T502801	100mm	1	10	£8.50

PRO LASER LEVEL



FEATURES

- Self levelling green cross line laser with an extremely tough shock proof rubber casing
- Working Range: 30meter /60 meter with detector
- Level Accuracy:±0.2mm/m
- Self-Levelling Range: 3°
- Power: 3 x 1.5 V LR6 (AA)
- Laser Class: 2



CHECK OUT THE YOUTUBE TUTORIAL HERE

Product Code	Size	Order Qty	Box Qty	List Price
OX-P502901	-	1	4	£225.00



PRO GREEN LASER LEVEL DETECTOR



FEATURES

- Easy to use laser level detector compatible with OX self levelling line lasers
- Suitable for detecting green laser beams in bright light or difficult to discern situations over long distances
- Laser detection range up to 60 meters; Vertical of 1-35mm
- Accurate up to +/- 2.5mm
- Includes clamp for easy placement around site
- Bright, easy to see indicator lights
- Visible and audible indicator signs
- Automatic shutdown
- Low voltage alarm

Product Code	Size	Order Qty	Box Qty	List Price
OX-P502902	-	1	50	£108.40

PRO TRIPOD AND POLE FOR LASER LEVELS



FEATURES

- Strong lightweight construction
- Fully adjustable height for various site applications
- 3.2m Maximum Height
- Compatible with all laser levels with M6 screw thread
- Ergonomic and compact design makes tripod easy to carry
- Includes padded nylon protective carry case

Product Code	Size	Order Qty	Box Qty	List Price
OX-P505101	3.2m	1	1	£101.65



PRO TUFF RULE



Product Code	Size	Order Qty	Box Qty	List Price
OX-P507236	600mm Cyan	1	40	£15.75
OX-P507226	600mm High Visibility Green	1	40	£15.75
OX-P507206	600mm Black	1	40	£15.75



Check out the Tuff Rule youtube tutorial here.



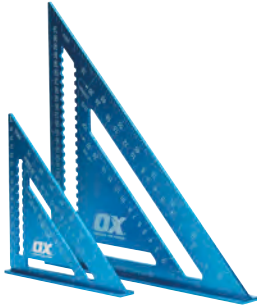

PRO ALUMINIUM RAFTERS SQUARE

FEATURES

- Scribe notches for marking 5mm increments
- Easy read laser-etched markings provide excellent readability and twice the accuracy of stamped squares
- Metric markings and conversion tables for rise and run application
- Extra-thick extruded aluminium body, anodised aluminium construction for durability (resists rust and corrosion)
- Wide base ensures a secure hold on materials and assists with saw guide usage

Product Code	Size	Order Qty	Box Qty	List Price
OX-P506518	180mm	1	10	£12.31
OX-P506530	300mm	1	8	£21.36



PRO ADJUSTABLE ALUMINIUM RAFTER SQUARE

FEATURES

- Anodised aluminium construction for added durability
- Easy to read laser etched markings
- Features Common, jack and hip and valley scales for various applications
- Supplied with adjustable arm
- Scribe notches for marking 5mm increments

Product Code	Size	Order Qty	Box Qty	List Price
OX-P507818	180mm	1	10	£21.00



TRADE PLASTIC RAFTERS SQUARE SET

FEATURES

- Includes 180mm & 300mm rafter square
- Made from heavy duty ABS plastic
- Easy to read gradations
- Wide base ensures a secure hold on materials and assists with saw guide use

Product Code	Size	Order Qty	Box Qty	List Price
OX-T433702	180mm & 300mm	1	10	£14.95



TRADE SLIDING BEVEL 200MM

FEATURES

- Easy read laser etched markings
- Reinforced locking nut for secure transfer of angles
- High-quality stainless-steel blade with double-sided scale
- Built in dual vials offering extra functionality and accuracy

Product Code	Size	Order Qty	Box Qty	List Price
OX-T507420	200mm	1	24	£8.95



PRO MAGNETIC COMBINATION SQUARE

FEATURES

- Unique magnetic lock for easy movement of the steel rule
- Stainless steel rule engraved with both imperial & metric graduations
- 5 milled sides for superior accuracy
- Magnet-held stainless steel scribe

Product Code	Size	Order Qty	Box Qty	List Price
OX-P504530	300mm/12"	1	4	£41.09

PRO COMBINATION SQUARE

FEATURES

- High quality cast and machined sliding stock
- Stainless steel rule engraved with both imperial & metric graduations
- Can mark 90° and 45° with adjustable depth for repetition marking & scribing



CHECK OUT THE YOUTUBE TUTORIAL HERE

Product Code	Size	Order Qty	Box Qty	List Price
OX-P025630	300mm/12"	1	30	£18.69



PRO CARPENTERS SQUARE & ANGLE INDICATOR

FEATURES

- Unique support ledge
- High-impact polymer handle
- Permanently etched stainless steel blade
- 22.5°, 45°, 67.5° and 90° angle indicators

Product Code	Size	Order Qty	Box Qty	List Price
OX-P503030	300mm/12"	1	4	£15.00



PRO CARPENTERS SQUARE 600 X 400MM

FEATURES

- Heavy duty carbon steel
- Laser etched metric & imperial markings
- Epoxy coated for longer life
- Long Edge Width: 51mm/Short Edge Width: 38.5mm

Product Code	Size	Order Qty	Box Qty	List Price
OX-P021064	600 X 400mm	1	24	£11.18



PRO KEVLAR® CHALK LINE REEL & REFILL

Designed to feel comfortable in the hand.

30 metre ultra strong Kevlar® line.

6 to 1 gear ratio makes for a quick rewind, saving time after laying a chalk line.

Intelligent hook design offers a strong grip and accuracy when laying chalk.

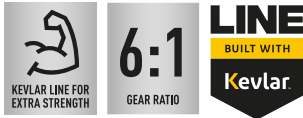

Product Code	Size	Order Qty	Box Qty	List Price
OX-P506302	30m/100ft	1	12	£20.97





PRO HEAVY DUTY CHALK LINE REEL

FEATURES

- 5:1 Gear ratio for fast rewind
- Twisted polyester string for strength and durability
- Chalk powder not included

Product Code	Size	Order Qty	Box Qty	List Price
OX-P027730	30m/100ft	1	4	£27.60



TRADE HEAVY DUTY CHALK LINE REEL

FEATURES

- Dual use - can be used as plumb bob
- High impact cast metal body
- Stainless-steel hook
- Chalk powder not included

Product Code	Size	Order Qty	Box Qty	List Price
OX-T020830	30m/100ft	1	12	£11.18



PRO CHALK POWDER 80Z

FEATURES

- Powder formulated for good adhesion and high visibility
- For both interior & exterior use
- For use with chalk lines
- Easy pour, refillable bottle

Product Code	Size	Order Qty	Box Qty	List Price
OX-P025701	Red/8oz (226g)	1	6	£4.95
OX-P025702	Blue/8oz (226g)	1	6	£4.95
OX-P025703	Yellow/8oz (226g)	1	6	£4.95
OX-P025704	White/8oz (226g)	1	6	£4.95



SECTION 03

WOODWORKING TOOLS





PRO HEAVY DUTY BAR CLAMP

FEATURES

- Very heavy duty construction for durability
- High clamping force – 150kg
- Quick change conversion from clamp to spreader
- TPR Jaw pads protect surfaces from damage



CHECK OUT THE YOUTUBE TUTORIAL HERE

Product Code	Size	Order Qty	Box Qty	List Price
OX-P201206	6"/150mm	1	10	£28.38
OX-P201212	12"/300mm	1	10	£32.54
OX-P201218	18"/450mm	1	10	£36.69
OX-P201224	24"/600mm	1	10	£41.48
OX-P201236	36"/900mm	1	10	£52.63



PRO SOLID STEEL DOOR CLAMP

FEATURES

- Solid steel, fully welded
- Holds door when; attaching hinges, routing, hanging, rebating
- Comfortable soft grip handles
- Felt covered jaws for protection against door damage
- Fits all doors – from 18mm 'built in' doors to 65mm 'fire rated' doors

Product Code	Size/Description	Order Qty	Box Qty	List Price
OX-P200101	49cm x 30cm	1	3	£106.95

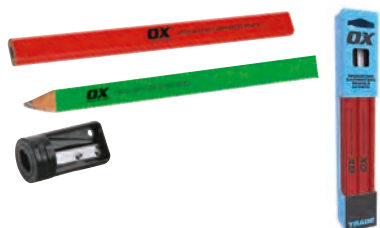

TRADE CARPENTER'S PENCILS – 10PK

FEATURES

- 10 Carpenters pencils with FREE sharpener included
- Medium lead (Red) or Hard lead (Green) available

Product Code	Size/Description	Order Qty	Box Qty	List Price
OX-T022910	10 Pack Medium (Red)	12	12	£6.00
OX-T023010	10 Pack Hard (Green)	12	12	£6.00



PRO TUFF CARBON PENCIL



Pencil Value Pack



Basic Colour & Graphite



Graphite Lead



Pencil Lead Tiles

Product Code	Description	Order Qty	Box Qty	List Price
OX-P503201	Marking Pencil	10	10	£13.04
OX-P503202	Basic Colour & Graphite	10	10	£9.52
OX-P503203	Graphite Lead	10	10	£8.93
OX-P503204	Pencil Lead -Tiles	10	10	£9.52
OX-P503210	Pencil Value Pack	10	10	£14.88



PRO WOOD CHISEL - VARIOUS SIZES

FEATURES

- Forged steel core - superior strength & durability
- Split-proof acetate handle designed tough to last
- Extra large strike cap to withstand hammer strikes & can be hit from multiple angles
- High quality hardened steel blade giving sustained performance and edge retention
- Soft grip non-slip handle for increased comfort and durability during use



Product Code	Size	Order Qty	Box Qty	List Price
OX-P371106	6mm/1/4"	1	6	£11.89
OX-P371110	10mm/3/8"	1	6	£12.12
OX-P371113	13mm/1/2"	1	6	£12.25
OX-P371116	16mm/5/8"	1	6	£12.48
OX-P371119	19mm/3/4"	1	6	£12.70
OX-P371122	22mm/7/8"	1	6	£12.92
OX-P371125	25mm/1"	1	6	£13.17
OX-P371132	32mm/1-1/4"	1	6	£14.09
OX-P371138	38mm/1-1/2"	1	6	£14.99

PRO WOOD CHISEL SET - 3 PC

FEATURES

- 3 pc wood chisel set
- Forged steel core - superior strength & durability
- High quality hardened steel blade giving sustained performance and edge retention
- Packaged in a high quality velcro case



Product Code	Size	Order Qty	Box Qty	List Price
OX-P371203	13, 19 & 25mm	1	4	£45.00

PRO WOOD CHISEL SET 5 PC

FEATURES

- 5 pc wood chisel set
- Packaged in a high quality velcro case
- Forged steel core - superior strength & durability
- Split-proof acetate handle designed tough to last
- Extra large strike cap to withstand hammer strikes & can be hit from multiple angles
- High quality hardened steel blade giving sustained performance and edge retention



Product Code	Size	Order Qty	Box Qty	List Price
OX-P371005	6, 10, 16, 19 & 25mm	1	4	£65.00

PRO SCREWDRIVER VARIOUS SIZES

FEATURES

- Soft grip handle moulded directly to shaft for ultimate strength
- Colour coded handles & magnetic tips



Product Code	Size	Order Qty	Box Qty	List Price
OX-P362275	Slotted Flared 75x4mm	1	12	£3.12
OX-P362210	Slotted Flared 100x5.5mm	1	12	£3.82
OX-P362212	Slotted Flared 125x6.5mm	1	12	£4.64
OX-P362215	Slotted Flared 150x8mm	1	12	£6.28
OX-P362220	Slotted Flared 200x10mm	1	12	£7.01
OX-P362225	Slotted Flared 250x10mm	1	12	£7.54
OX-P362338	Slotted Flared Stubby 6.5x38mm	1	12	£3.18
OX-P362410	Slotted Parallel 100x4mm	1	12	£3.10
OX-P362415	Slotted Parallel 150x5.5mm	1	12	£4.02
OX-P362420	Slotted Parallel 200x5.5mm	1	12	£4.25
OX-P362425	Slotted Parallel 250x6.5mm	1	12	£5.37
OX-P362575	Phillips PH1 x 75mm	1	12	£3.73
OX-P362510	Phillips PH2 x 100mm	1	12	£4.50
OX-P362515	Phillips PH2 x 150mm	1	12	£4.79
OX-P362675	Pozi PZ0x75mm	1	12	£2.91
OX-P362710	Pozi PZ1x100mm	1	12	£3.82
OX-P362725	Pozi PZ1x250mm	1	12	£4.52
OX-P362812	Pozi PZ2x125mm	1	12	£4.64
OX-P362825	Pozi PZ2x250mm	1	12	£5.42
OX-P362915	Pozi PZ3x150mm	1	12	£6.28
OX-P363020	Pozi PZ4x200mm	1	12	£7.01

PRO MULTIBIT RATCHET SCREWDRIVER

FEATURES

- Easy access bit storage inside end of handle
- Chrome vanadium bits
- Lockable ratchet
- Contains: 4mm/5mm/6mm slotted, PH1/PH2/PH3 Phillips, PZ1/PZ2/PZ3 Pozidrive, T10/T15/T20 Torx bits



Product Code	Size	Order Qty	Box Qty	List Price
OX-P361501	See above	1	12	£17.76

PRO 2 PIECE LONG SCREWDRIVER SET

FEATURES

- Made from high degree CRV steel
- Magnetic tip for easy screw pickup
- Long reach 300mm
- PZ2 pozi and slotted screwdrivers
- Soft grip handle moulded directly to shaft for ultimate strength
- Colour coded handles



Product Code	Size	Order Qty	Box Qty	List Price
OX-P363302	Pozi PZ2x300mm	1	24	£8.51



PRO SCREWDRIVER SET – 7PC

FEATURES

- High quality screwdrivers with chrome vanadium steel bar
- Soft grip handle moulded directly to shaft for ultimate strength
- Colour coded handles & magnetic tips
- Set includes: Flared 5.5 x 100mm, 6.5 x 100mm Parallel 4 x 100mm, Phillips PH1 x 75mm, PH2 x 100mm, Pozi PZ1 x 100mm, PZ2 x 125mm
- Supplied in cardboard display case

Product Code	Size	Order Qty	Box Qty	List Price
OX-P363107	-	1	8	£23.75



PRO TOUGH SCREWDRIVER SET WITH HARD CASE – 7PC

FEATURES

- Pro series 7pc set
- Chrome vanadium steel bar
- Soft grip handle moulded directly to shaft for ultimate strength
- Colour coded handles
- Robust, heavy duty case
- Set includes: Flared 6.5 x 150mm, Parallel 3.5 x 75mm & 5.5 x 125mm, Phillips PH1 x 100mm, PH2 x 125mm, Pozi PZ1 x 100mm, PZ2 x 125mm

Product Code	Size	Order Qty	Box Qty	List Price
OX-P360207	-	1	5	£47.84



PRO HEX KEY SET – 9PC

FEATURES

- Ball-end design aids access to bolts in hard to reach places
- Diamond tip to eliminate cam-out, protecting both the bolt and the hex key
- Ensuring longer life than standard hex keys
- Chrome Vanadium Steel Construction
- Chemically blackened finish to prevent rusting
- Contains 9 metric size Hex keys 1.5mm – 10mm

Product Code	Size	Order Qty	Box Qty	List Price
OX-P322409	-	1	6	£26.81



SECTION 04

CUTTING TOOLS





PRO HEAVY DUTY FIXED BLADE FOLDING KNIFE

FEATURES

- Ultra sharp steel blades
- Easy change blade button pointer locks in four positions
- Blade storage compartment in handle and includes x3 replaceable blades
- Strong lightweight construction
- Built in notch for stripping wire and straps
- Ergonomically designed handle
- Lanyard eyelet for tethering
- Quick fold action
- Notched thumb rest for enhanced grip
- Sturdy Belt Hook on reverse
- Tool free blade change

Product Code	Size	Order Qty	Box Qty	List Price
OX-P224301	-	1	10	£9.92



PRO FIXED FOLDING KNIFE

FEATURES

- Compact foldable design
- Blade storage in handle
- Very fast blade change

Product Code	Size	Order Qty	Box Qty	List Price
OX-P221301	-	1	12	£12.16



PRO RETRACTABLE FOLDING KNIFE

FEATURES

- Retractable blade knife with easy folding mechanism
- Blade storage in handle
- Instant blade change

Product Code	Size	Order Qty	Box Qty	List Price
OX-P223501	-	1	12	£13.96



PRO HEAVY DUTY UTILITY KNIFE

FEATURES

- Quick blade changing - accepts most standard utility blades
- Firm grip handle
- Magnetic tip
- Storage for blade dispenser - 10 Blades included

Product Code	Size	Order Qty	Box Qty	List Price
OX-P220310	-	1	12	£20.09



TRADE HEAVY DUTY KNIFE

FEATURES

- Heavy duty knife with tough metal construction
- Accepts most standard utility blades
- Blade storage in handle
- Retractable blade

Product Code	Size	Order Qty	Box Qty	List Price
OX-T222701	-	1	12	£8.76



TRADE RETRACTABLE UTILITY KNIFE

FEATURES

- Tough metal construction
- Accepts most standard utility blades
- Blade storage in handle

Product Code	Size	Order Qty	Box Qty	List Price
OX-T220601	-	1	12	£6.98



TRADE UTILITY KNIFE

FEATURES

- Ergonomic body shape for comfort during long periods of use
- Tough metal construction
- Soft grip insert for added grip

Product Code	Size	Order Qty	Box Qty	List Price
OX-T224101	-	1	12	£4.37



PRO SNAP OFF KNIFE & BLADES COMBO PACK 25MM

FEATURES

- Reinforced twist lock for extra strength
- OX ultracut coated blades that stay sharp for longer
- OX grip elastomer/TPR body
- Comes with 5 blades

Product Code	Size	Order Qty	Box Qty	List Price
OX-P224625	-	1	10	£8.51



TRADE SNAP OFF KNIFE 18MM

FEATURES

- High quality fantastic value 18mm snap off blade knife
- Supplied with 2 spare blades stored within the handle
- Unique Japanese ultra sharp black snap off blades made from premium grade steel and tempered for the optimum balance of hardness and pliability

Product Code	Description	Order Qty	Box Qty	List Price
OX-T223818	Snap Off Knife	1	10	£9.15
OX-P223910	Blade - 10 Pack	1	20	£7.83



PRO HEAVY DUTY KNIFE BLADES - 10/100 PACK

FEATURES

- General purpose heavy duty blades in dispenser
- High quality SK2 steel - extra flexible and durable

Product Code	Size	Order Qty	Box Qty	List Price
OX-P222010	10 Pack	1	20	£2.32
OX-P222110	100 Pack	1	6	£15.37

PRO HOOKED KNIFE BLADE - 10/100 PACK

FEATURES

- Hooked heavy-duty blades in dispenser
- High quality SK2 steel - extra flexible and durable



Product Code	Size	Order Qty	Box Qty	List Price
OX-P222510	10 Pack	1	20	£3.04
OX-P222610	100 Pack	1	6	£26.22

TRADE WINDOW SCRAPER

FEATURES

- Comfortable moulded plastic handle
- Detachable blade guard
- Uses standard trimming knife blade



Product Code	Size	Order Qty	Box Qty	List Price
OX-T051501	-	1	25	£2.00

PRO HEAVY DUTY FLOOR SCRAPER

FEATURES

- Heavy duty chrome plated solid steel handle
- Cushion grip
- Solid steel hammer end cap
- The heaviest duty scraper on the market today



Product Code	Size	Order Qty	Box Qty	List Price
OX-P051218	5"/127mm	1	6	£30.18
OX-P051310	Replacement Blades - 10 pk	1	20	£9.34

PRO BOLT CROPPERS

FEATURES

- Heat treated alloy jaws
- Rated to cut HRC40



Product Code	Size	Order Qty	Box Qty	List Price
OX-P230118	450mm/18"	1	2	£37.75
OX-P230124	600mm/24"	1	2	£47.90
OX-P230130	750mm/30"	1	2	£68.83
OX-P230136	900mm/36"	1	2	£90.32
OX-P230142	1050mm/42"	1	2	£124.27

PRO SNIPS

FEATURES

- 185mm (7") durable ultra sharp snips
- Comfort grip ergonomically designed handles
- Stainless Steel serrated edge blades for increased cutting capacity
- Ideal for all industrial applications including wire netting, light gauge aluminium, carpet, leather, Kevlar®, and many other items
- Ideal knife replacement tool



CHECK OUT THE YOUTUBE TUTORIAL HERE



Product Code	Cut Direction	Order Qty	Box Qty	List Price
OX-P233001	Straight	1	12	£20.75

PRO HEAVY DUTY AVIATION SNIPS

FEATURES

- Extra sharp long life serrated jaws for fast accurate cutting
- Ergonomic and comfortable soft grip handles
- Internal one handed auto release system



Product Code	Cut Direction	Order Qty	Box Qty	List Price
OX-P232801	Left (red)	1	4	£25.00
OX-P232802	Right (green)	1	4	£25.00
OX-P232803	Straight (yellow)	1	4	£25.00

PRO AVIATION SNIPS

FEATURES

- Heat treated alloy jaws - fully adjustable and replaceable
- Rated to cut HRC49
- Max cut 1.5mm mild steel/0.9 stainless steel



Product Code	Cut Direction	Order Qty	Box Qty	List Price
OX-P231001	Left (red)	1	4	£20.00
OX-P231002	Right (green)	1	4	£20.00
OX-P231003	Straight (yellow)	1	4	£20.00

TRADE AVIATION SNIPS

FEATURES

- Soft grip ergonomic handle
- Locking mechanism
- Ultra strong construction
- Straight cut jaw



Product Code	Cut Direction	Order Qty	Box Qty	List Price
OX-T232901	Straight	1	4	£9.98

PRO STRAIGHT TIN SNIPS

FEATURES

- Hardened steel for durability and clean cut
- Non-slip comfort grip handle



Product Code	Size	Order Qty	Box Qty	List Price
OX-P223010	250mm	1	6	£24.72

CUTTING TOOLS

PRO EASY START HAND SAW - 22"



Ergonomically designed soft grip handle for comfort during use.

Hardened teeth for durability and longer life.

Teflon coated blade reduces heat, expansion and friction for greater cutting efficiency.

Engineered 8TPI and 65NM blade configuration for precision and razor-sharp cutting capability.

Superfine 13TPI cutting teeth for initializing cuts easier and faster.

Product Code	Size	Order Qty	Box Qty	List Price
OX-P133855	550mm/22"	1	10	£15.95





PRO HAND SAW 20" & 22"

FEATURES

- Ultimate Ergonomic soft grip handle for extreme comfort and increased power
- Triple ground and impulse hardened teeth for aggressive cutting and longer life
- Improved stability for faster cutting
- Integral 45 and 90 degree angles built into handle
- Suitable for Universal cutting
- 8 teeth per inch, 1mm blade thickness

Product Code	Size	Order Qty	Box Qty	List Price
OX-P133250	500mm/20"	1	10	£11.68
OX-P133255	550mm/22"	1	10	£12.81



TRADE HAND SAW 20" & 22"

FEATURES

- High quality 1mm steel blade with double ground and impulse hardened teeth for a fast clean cut
- 8 TPI (teeth per inch) for fast universal cutting with or across the grain
- Heavy duty screwed robust handle designed to be comfortable and durable

Product Code	Size	Order Qty	Box Qty	List Price
OX-T130950	500mm/20"	1	10	£7.31
OX-T130955	550mm/22"	1	10	£7.81
OX-T133703	Triple Pack 22"	1	4	£23.42



PRO JAB SAW WITH HOLSTER

FEATURES

- Professional metal heavy duty jab saw with ergonomic soft grip handle
- Hardened & tempered blade for aggressive cutting - triple ground teeth
- Sharp point for piercing board
- Supplied with heavy duty holster for safe storage when not in use
- Fast cutting for drywall, wood & plastic



CHECK OUT THE YOUTUBE TUTORIAL HERE

Product Code	Size	Order Qty	Box Qty	List Price
OX-P133116	165mm/6.5"	1	12	£20.81



TRADE JAB SAW WITH HOLSTER

FEATURES

- Supplied with protective holster for safety when not in use
- Hardened & tempered steel blade for increased life
- 8 Teeth per inch
- Non-slip ergonomic handle
- Excellent for wood, plastic & drywall

Product Code	Size	Order Qty	Box Qty	List Price
OX-T131516	165mm/6.5"	1	10	£13.23



PRO BOW SAW 533MM

FEATURES

- Pointed nose for better access in tight areas
- Robust extra heavy duty build for excellent stability & strength
- Ergonomic handle that absorbs cutting vibration
- Built in adjustable tensioning system to ensure greater precision and easy replacement of saw blade

Product Code	Size	Order Qty	Box Qty	List Price
OX-P133321	533mm/21"	1	5	£26.11

REPLACEMENT BLADE

Product Code	Size	Order Qty	Box Qty	List Price
OX-P133421	533mm/21"	1	200	£3.00



PRO HIGH TENSION HACKSAW 300MM

FEATURES

- Quick change blade design - 230kg High blade tension
- Bi grip rubber handle
- Blade in either 45° /90° cut position
- No tools needed to change blade

Product Code	Size	Order Qty	Box Qty	List Price
OX-P130730	300mm/12"	1	6	£35.03



PRO HACKSAW BLADES 300MM

FEATURES

- Cuts aluminium, iron, copper, carbon steel and hard plastic
- Pack of 4 blades

Product Code	Size	Order Qty	Box Qty	List Price
OX-P131318	18 TPI	1	50	£7.78
OX-P131324	24 TPI	1	50	£7.78
OX-P131332	32 TPI	1	50	£7.78



PRO MINI HACKSAW 150MM

FEATURES

- Bi grip rubber handle
- 6 Blade angle settings
- Industrial strength hacksaw

Product Code	Size	Order Qty	Box Qty	List Price
OX-P130815	150mm/6"	1	12	£12.60



PRO HACKSAW BLADES 150MM

FEATURES

- Cuts aluminium, iron, copper, carbon steel and hard plastic
- Pack of 10 blades

Product Code	Size	Order Qty	Box Qty	List Price
OX-P131424	24 TP1	1	24	£9.17

SECTION 05

BRICKLAYING TOOLS





PRO BRICK TROWEL PHILADELPHIA

FEATURES

- Solid forged steel blade for ultimate strength
- Precision tapered ground blade
- DURAGRIP handle with finger protection for extreme comfort
- Hard end handle for tapping in bricks
- Well balanced & perfect flexibility



CHECK OUT THE YOUTUBE TUTORIAL HERE

Product Code	Size	Order Qty	Box Qty	List Price
OX-P011210	250mm/10"	1	6	£43.24
OX-P011211	280mm/11"	1	6	£44.03
OX-P011212	300mm/12"	1	4	£45.22



PRO BRICK TROWEL LONDON

FEATURES

- Solid forged steel blade for ultimate strength
- Precision tapered ground blade
- DURAGRIP handle with finger protection for extreme comfort
- Hard end handle for tapping in bricks
- Well balanced & perfect flexibility

Product Code	Size	Order Qty	Box Qty	List Price
OX-P011111	280mm/11"	1	6	£44.03



PRO POINTING TROWEL PHILADELPHIA

FEATURES

- DURAGRIP handle with finger protection
- High quality carbon steel
- Straight welded shank
- Soft grip handle for extreme comfort

Product Code	Size	Order Qty	Box Qty	List Price
OX-P018504	102mm/4"	1	6	£12.55
OX-P018505	127mm/5"	1	6	£12.55
OX-P018506	152mm/6"	1	6	£12.55



PRO POINTING TROWEL LONDON

FEATURES

- DURAGRIP handle with finger protection
- High quality carbon steel
- Straight welded shank
- Soft grip handle for extreme comfort

Product Code	Size	Order Qty	Box Qty	List Price
OX-P013604	102mm/4"	1	6	£12.55
OX-P013605	127mm/5"	1	6	£12.55
OX-P013606	152mm/6"	1	6	£12.55



PRO GAUGING TROWEL

FEATURES

- High quality carbon steel
- Well balanced & perfect flexibility
- Soft grip handle for extreme comfort

Product Code	Size	Order Qty	Box Qty	List Price
OX-P011407	180mm/7"	1	6	£16.26



PRO BRICK JOINTER

FEATURES

- For a professional finish to joints between bricks
- Heavy duty design
- High quality steel
- Sizes clearly engraved onto tool

Product Code	Size	Order Qty	Box Qty	List Price
OX-P031101	13 x 16mm/1/2" x 3/8"	1	6	£7.01
OX-P031102	19 x 22mm/3/4" x 7/8"	1	6	£7.01
OX-P031103	16 x 19mm/5/8" x 3/4"	1	6	£7.01
OX-P031104	10 x 13mm/2/8" x 1/2"	1	6	£7.01



PRO BRICK JOINT RAKER

FEATURES

- Designed for clearing out mortar from between brickwork prior to pointing
- Strong aluminium handle contoured to fit the hand
- Two hardwearing wheels and replaceable point

Product Code	Size	Order Qty	Box Qty	List Price
OX-P031003	-	1	6	£13.73



PRO TUCK POINTER

FEATURES

- One piece high quality carbon steel blade
- DURAGRIP handle with finger protection
- Soft grip handle for extreme comfort

Product Code	Size	Order Qty	Box Qty	List Price
OX-P011508	8mm /1/2"	1	12	£9.58
OX-P011510	10mm /3/8"	1	12	£9.84
OX-P011512	12mm /1/2"	1	12	£10.03
OX-P011519	19mm /3/4"	1	12	£11.51
OX-P011525	25mm/1"	1	12	£12.02



TRADE BRICK TROWEL PHILADELPHIA

FEATURES

- Quality carbon steel blade
- Tempered blade for strength
- Durable timber handle

Product Code	Size	Order Qty	Box Qty	List Price
OX-T017528	280mm/11"	1	12	£7.66



TRADE BRICK TROWEL LONDON

FEATURES

- Quality carbon steel blade
- Tempered blade for strength
- Durable timber handle

Product Code	Size	Order Qty	Box Qty	List Price
OX-T017428	280mm/11"	1	12	£7.66



TRADE POINTING TROWEL WOODEN HANDLE

FEATURES

- Quality carbon steel blade
- Tempered blade for strength
- Durable timber handle

Product Code	Size	Order Qty	Box Qty	List Price
OX-T017813	127mm/5"	1	12	£3.12
OX-T017915	152mm/6"	1	12	£3.27



TRADE GAUGING TROWEL WOODEN HANDLE

FEATURES

- Quality carbon steel blade
- Tempered blade for strength
- Durable timber handle

Product Code	Size	Order Qty	Box Qty	List Price
OX-T017718	180mm/7"	1	12	£4.50



TRADE BUCKET TROWEL WOODEN HANDLE

FEATURES

- Quality carbon steel blade
- Tempered blade for strength
- Durable timber handle

Product Code	Size	Order Qty	Box Qty	List Price
OX-T017618	180mm/7"	1	12	£4.85



PRO BRICK CARRIER

FEATURES

- Holds 8-12 bricks
- Adjustable jaw capacity
- Heavy duty construction
- Comfort grip ergonomic handle

Product Code	Size	Order Qty	Box Qty	List Price
OX-P171250	-	1	8	£38.95

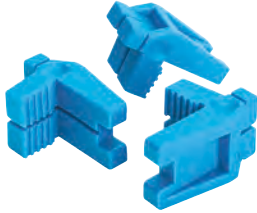

PRO RUBBER LINE BLOCKS

FEATURES

- 1 Piece rubber line block
- Lightweight and durable
- 40 pieces in colour card display box

Product Code	Size	Order Qty	Box Qty	List Price
OX-P101801	-	1	40	£3.26



PRO LINE PINS - 2 PACK

FEATURES

- Made from solid forged carbon steel for ultimate strength
- Taper ground point & edges – drives easily into the wall
- Chrome plated for fine finish, extra wear resistance and rust prevention
- Pack of 2

Product Code	Size	Order Qty	Box Qty	List Price
OX-P100102	152mm/6"	1	12	£9.10



PRO NYLON BRAIDED BUILDERS LINE 105M

FEATURES

- Ultra tough braided nylon brickline
- Cyan colour for high visibility

Product Code	Size	Order Qty	Box Qty	List Price
OX-P104210	105m/350ft	1	12	£12.59



PRO CYAN BRICKLINE 105M

FEATURES

- Made from tough braided nylon line
- OX blue colour for high visibility
- Very high quality durable material
- High tension to minimise sagging

Product Code	Size	Order Qty	Box Qty	List Price
OX-P103510	105m/350ft	1	12	£10.55



PRO DUTCH PINS 4PK

FEATURES

- Semi-round swivel arm
- Solid forged and hardened
- Made from high quality galvanised steel

Product Code	Size	Order Qty	Box Qty	List Price
OX-P100715	100 x 150mm	1	4	£45.51



PRO DORI BLOCK WITH LOCK BOLT

FEATURES

- Genuine replacement part
- Zinc plated solid steel
- 'T' bolt/thumb screw
- Can be clamped to the profile pole from either side
- Use with 40 & 50mm profile poles

Product Code	Size	Order Qty	Box Qty	List Price
OX-P100950	50 x 50mm	1	4	£15.00



PRO MORTAR SPIKE

FEATURES

- Zinc plated solid steel
- New 'thread insert' threading system
- 'T' bolt/thumb screw & thread length 80mm

Product Code	Size	Order Qty	Box Qty	List Price
OX-P102201	120 x 30mm	1	4	£8.95



PRO SLIDING PROFILE CLAMP

FEATURES

- Zinc plated solid steel
- 'T' bolt/thumb screw
- Thread length 80mm

Product Code	Size	Order Qty	Box Qty	List Price
OX-P101213	330mm	1	4	£14.95



PRO PROFILE CLAMP

FEATURES

- Solid steel & zinc plated
- 'T' bolt/thumb screw
- Thread length 80mm

Product Code	Size	Order Qty	Box Qty	List Price
OX-P100302	50mm	1	4	£8.95
OX-P100307	178mm	1	4	£9.95
OX-P100312	300mm	1	4	£11.95

PRO INTERNAL PROFILE CLAMP

FEATURES

- Solid steel & zinc plated
- T' bolt thumb screw
- Thread length 80mm



Product Code	Size	Order Qty	Box Qty	List Price
OX-P102007	178mm	1	4	£9.95
OX-P102012	300mm	1	4	£11.95

PRO NAIL ON PROFILE CLAMP

FEATURES

- New 'thread' insert threading system
- Zinc plated solid steel
- T' bolt/thumb screw
- Thread length 80mm



Product Code	Size	Order Qty	Box Qty	List Price
OX-P102114	350mm	1	4	£11.90



SECTION 06

PLASTERING & DRY LINING TOOLS



PRO PLASTERERS TROWEL STAINLESS STEEL

FEATURES

- Pre-worn edges to eliminate line & ripple marks
- High quality tempered stainless steel blade
- Lightweight aluminium shank - fully riveted
- Handle set for perfect balance
- DURAGRIP handle for ultimate comfort



Product Code	Size	Order Qty	Box Qty	List Price
OX-P011011	114 x 280mm / 4 1/2" x 11"	1	6	£40.11
OX-P011014	127 x 356mm / 5" x 14"	1	6	£43.45
OX-P011018	127 x 457mm / 5" x 18"	1	6	£53.47

PRO PLASTERERS TROWEL CARBON STEEL

FEATURES

- Pre-worn edges to eliminate line & ripple marks
- High quality tempered carbon steel blade
- Lightweight aluminium shank - fully riveted
- Handle set for perfect balance
- DURAGRIP handle for ultimate comfort



Product Code	Size	Order Qty	Box Qty	List Price
OX-P010911	127 x 457mm / 4 3/4" x 11"	1	6	£37.27
OX-P010914	120 x 356mm / 4 3/4" x 14"	1	6	£41.68
OX-P010918	115 x 457mm / 4 1/2" x 18"	1	6	£52.36

PRO SMALL TROWEL

FEATURES

- Stainless steel properly shaped & tempered
- Fully riveted shank
- Lightweight but very strong aluminium shank
- DURAGRIP handle for ultimate comfort



Product Code	Size	Order Qty	Box Qty	List Price
OX-P013808	200 x 75mm / 8" x 3"	1	6	£29.92

TRADE PLASTERING TROWEL

FEATURES

- High grade flexible blade
- Award winning soft grip ergonomic handle design
- Heavy duty aluminium shank



Product Code	Size	Order Qty	Box Qty	List Price
OX-T534112	114 x 280mm / 11"	1	8	£10.64

TRADE PLASTIC TROWEL 2MM BLADE

FEATURES

- Plastic Trowel with 2mm Nylon Blade for use on renders, cements and resins
- Perfect for rubbing up the colour coat of silicone render
- Light and ergonomic handle
- 2mm Blade thickness
- Size: 11" (270x130mm)



Product Code	Size	Order Qty	Box Qty	List Price
OX-T537402	270mm/11"	1	8	£6.95



PRO PIPE TROWEL

FEATURES

- Strong and lightweight aluminium shank
- High quality steel blade
- DURAGRIP handle for ultimate comfort
- Used for working plaster or cement behind pipes or other difficult to reach places

Product Code	Size	Order Qty	Box Qty	List Price
OX-P0110003	260 x 75mm/10½" & 3"	1	6	£19.88



PRO DRY WALL INTERNAL CORNER TROWEL

FEATURES

- Flexible stainless steel blade with strong aluminium mounting
- Flexes for perfect 90° corners
- Curved corners to eliminate lines in plaster

Product Code	Size	Order Qty	Box Qty	List Price
OX-P013001	102 x 127mm/4" x 5"	1	6	£14.22



PRO DRY WALL EXTERNAL CORNER TROWEL

FEATURES

- Flexible stainless steel blade – 90° radius
- DURAGRIP handle for extreme comfort

Product Code	Size	Order Qty	Box Qty	List Price
OX-P013105	100 x 125mm/4" x 5"	1	6	£15.11



PRO EXTERNAL CORNER TROWEL STAINLESS STEEL

FEATURES

- Ideal for smoothing plaster in hard-to-reach corners
- Curved corners to eliminate lines in plaster
- Flexible stainless-steel blade with strong aluminium mounting
- Flexes for perfect 90° corners
- Riveted shank for greater strength and durability
- Ergonomically designed DURAGRIP handle for comfort during use

Product Code	Size	Order Qty	Box Qty	List Price
OX-P408601	30 x 80mm	1	6	£13.50
OX-P408801	60 x 80mm	1	6	£13.95



PRO INTERNAL CORNER TROWEL STAINLESS STEEL

FEATURES

- Ideal for smoothing plaster in hard-to-reach corners
- Curved corners to eliminate lines in plaster
- Flexible stainless-steel blade with strong aluminium mounting
- Flexes for perfect 90° corners
- Riveted shank for greater strength and durability
- Ergonomically designed DURAGRIP handle for comfort during use

Product Code	Size	Order Qty	Box Qty	List Price
OX-P408701	30 x 80mm	1	6	£13.50
OX-P408901	60 x 80mm	1	6	£13.95



PRO BUCKET TROWEL STAINLESS STEEL

FEATURES

- DURAGRIP handle with finger protection
- High quality stainless steel
- Heavy duty straight shank
- Soft grip handle for extreme comfort
- Rounded edges allow better access to remove material from the bottom of buckets
- Helps to reduce punctures or damage traditionally caused by sharp trowel edges

Product Code	Size	Order Qty	Box Qty	List Price
OX-P018418	180mm/7"	1	6	£18.21



PRO BUCKET TROWEL CARBON STEEL

FEATURES

- DURAGRIP handle with finger protection
- High quality carbon steel
- Heavy duty straight shank
- Rounded edges allow better access to remove material from the bottom of buckets
- Helps to reduce punctures or damage traditionally caused by sharp trowel edges

Product Code	Size	Order Qty	Box Qty	List Price
OX-P013718	180mm/7"	1	6	£12.57



PRO SMALL TOOL

FEATURES

- High quality carbon steel
- One piece drop forged
- Precision ground & tempered

Product Code	Size	Order Qty	Box Qty	List Price
OX-P010113	13mm	1	6	£12.48
OX-P010116	16mm	1	6	£12.48
OX-P010119	19mm	1	6	£12.48



PRO MARGIN TROWEL

FEATURES

- High quality carbon steel
- Flat rectangular blade
- DURAGRIP handle for extreme comfort
- Precision tapered ground blade

Product Code	Size	Order Qty	Box Qty	List Price
OX-P013405	125 x 50mm/5" x 2"	1	12	£12.04

PRO POLYURETHANE PLASTERERS FLOAT

FEATURES

- Lightweight sturdy construction
- Non-absorbent pattern face



Product Code	Size	Order Qty	Box Qty	List Price
OX-P016811	280 x 110mm/11" x 4 1/2"	1	10	£7.61
OX-P016815	350 x 150mm/14" x 6"	1	10	£9.72

PRO PLASTIC DIAMOND FACE FLOAT

FEATURES

- Diamond pattern face float
- Ideal for rubbing up silicone render and backing coat plasters
- Lightweight & easy to handle
- Manufactured from high strength ABS plastic - Size: 180mm x 270mm



Product Code	Size	Order Qty	Box Qty	List Price
OX-P012127	270 X 180mm/11"	1	8	£7.50

PRO POLYURETHANE PLASTERERS HAWK

FEATURES

- Lightweight sturdy construction

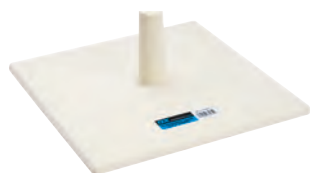

Product Code	Size	Order Qty	Box Qty	List Price
OX-P016933	330 x 330mm/13" x 13"	1	6	£17.68

PRO ALUMINIUM PLASTERERS HAWK

FEATURES

- High quality tempered aluminium blade
- Sturdy ergonomic soft grip handle with foam anti blister ring
- Machined concentric circles on blade to prevent mortar from sliding off



CHECK OUT THE YOUTUBE TUTORIAL HERE

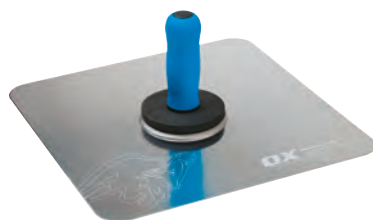

Product Code	Size	Order Qty	Box Qty	List Price
OX-P010513	330 x 330mm/13" x 13"	1	4	£36.70

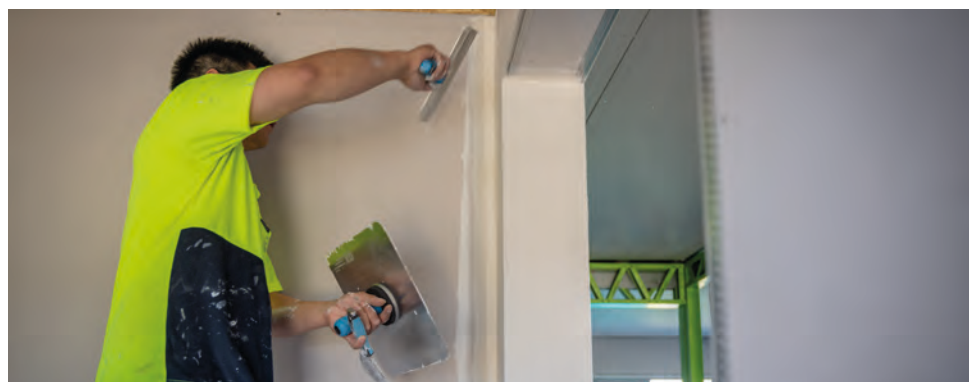

PRO JOINT KNIFE

FEATURES

- Flexible stainless steel blade
- Built-in hammer end
- DURAGRIP soft handle for extreme comfort



Product Code	Size	Order Qty	Box Qty	List Price
OX-P013203	32mm/1¼"	1	6	£7.71
OX-P013205	50mm/2"	1	6	£9.24
OX-P013207	76mm/3"	1	6	£10.63
OX-P013210	102mm/4"	1	6	£11.30
OX-P013212	127mm/5"	1	6	£11.81
OX-P013215	152mm /6"	1	6	£13.01

PRO TAPING KNIFE

FEATURES

- High quality flexible stainless steel blade
- DURAGRIP soft handle for extreme comfort
- Strong aluminium back



Product Code	Size	Order Qty	Box Qty	List Price
OX-P013320	200mm/8"	1	6	£15.47
OX-P013325	250mm/10"	1	6	£17.71
OX-P013330	300mm/12"	1	6	£18.66

PRO STAINLESS STEEL PLASTERERS MUD PAN

FEATURES

- Stainless steel construction
- Sheared sides for cleaning knives
- Polished interior surfaces for easy cleaning
- Tapered ends and sides
- Watertight seams
- Welded ends for a strong smooth interior finish
- Bottom of pan is contoured for easy scooping and clean up
- Smooth corners prevent build-up

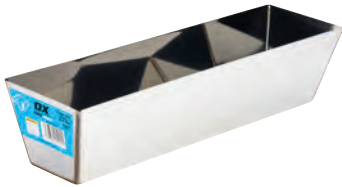

Product Code	Size	Order Qty	Box Qty	List Price
OX-P530812	300mm/12"	1	6	£13.11
OX-P530814	350mm/14"	1	6	£13.71

TRADE PLASTIC PLASTERERS MUD PAN

FEATURES

- Durable plastic construction
- Plastic pan designed to withstand variations in temperature
- Long-lasting and impact-resistant construction
- Built-in, rust-resistant steel blades angled to make wiping knives easier
- Ideal for mixing plaster, jointing compound & other fillers
- Suitable for blades up to 12" / 300mm wide



Product Code	Size	Order Qty	Box Qty	List Price
OX-T530712	300mm/12"	1	6	£5.57



PRO HAND SANDER

FEATURES

- Soft grip handle
- Lightweight durable design
- Fast changing sandpaper design Bonded foam pad

Product Code	Size	Order Qty	Box Qty	List Price
OX-P070701	80 X 240mm	1	4	£17.47



PRO HEAVY DUTY SWIVEL SANDER HEAD

FEATURES

- Lightweight easy swivel sanding head
- Unique quick release system
- Suitable for sandpaper size 80 x 230mm

Product Code	Size	Order Qty	Box Qty	List Price
OX-P071580	80 x 240mm	1	48	£11.07



PRO TELESCOPIC UNIVERSAL POLE

FEATURES

- Universal steel thread
- Unique double locking mechanism for extra stability

Product Code	Size	Order Qty	Box Qty	List Price
OX-P071601	1350-3500mm	1	24	£31.89



TRADE DRYWALL RASP

FEATURES

- Lightweight polypropylene handle and metal body
- For use on wood, aluminium, copper, plastic & laminates

Product Code	Size	Order Qty	Box Qty	List Price
OX-T071725	250mm	1	48	£19.76



PRO DRY WALL SCARIFIER

FEATURES

- High quality Scarifier for the preparation of drywall surfaces to help keying of plaster
- Heat treated tines fitted in strong aluminium back

Product Code	Size	Order Qty	Box Qty	List Price
OX-P051620	200mm/8"	1	6	£14.11
OX-P051625	250mm/10"	1	6	£15.54
OX-P051630	300mm/12"	1	6	£16.96



TRADE RENDER SCRAPER

FEATURES

- Heavy duty 2 component handle
- Galvanised metal spiked base plate
- Used for keying and scraping render surfaces

Product Code	Size	Order Qty	Box Qty	List Price
OX-T051425	250 x 130mm	1	20	£17.85

PRO SPONGE RUBBER FLOAT

FEATURES

- Sponge rubber Fine or Coarse cell pads cemented to aluminium backing plate



Product Code	Description	Order Qty	Box Qty	List Price
OX-P405301	Fine	1	5	£13.36
OX-P405401	Coarse	1	5	£13.36

PRO POLYMER SPONGE FLOAT

FEATURES

- One piece HDPS material
- Ergonomic handle
- Special 'fine cell' sponge



Product Code	Size	Order Qty	Box Qty	List Price
OX-P016411	120 x 300mm/4 7/8" x 12"	1	6	£14.77

TRADE FEATHER EDGES

FEATURES

- Combined feather edge & straight edge
- Mill finished aluminium construction
- Very light and manoeuvrable
- Printed scale for ruling



Product Code	Size	Order Qty	Box Qty	List Price
OX-T024812	1200mm/4ft	1	12	£40.11
OX-T024818	1800mm/6ft	1	12	£56.83

TRADE RENDERING I-BAR

FEATURES

- Ideal for scraping back render, to improve flatness and uniformity of finish
- Manufactured from lightweight aluminium, to reduce fatigue
- Rigid I-Shaped profile



Product Code	Size	Order Qty	Box Qty	List Price
OX-T537212	1200mm	2	12	£19.95

TRADE RENDERING H-BAR

FEATURES

- Ideal for scraping back render, to improve flatness and uniformity of finish
- Manufactured from lightweight aluminium, to reduce fatigue
- H-section feather edge with bevelled lip



Product Code	Size	Order Qty	Box Qty	List Price
OX-T537312	1200mm	2	12	£24.95

PRO HARLING TROWEL

FEATURES

- DURAGRIP handle with finger protection
- Used to throw pebbles onto the mortar when pebble dashing



Product Code	Size	Order Qty	Box Qty	List Price
OX-P0110106	165 x 165mm/6 1/2" & 6 1/2"	1	6	£18.23

PRO MIXING PADDLE HEX SHAFT

FEATURES

- Positive ribbon/hex shaft
- General purpose use on low to medium viscosity materials
- Chrome plated, durable, high quality steel



Product Code	Size	Order Qty	Box Qty	List Price
OX-P120308	80 x 400mm	1	12	£13.12
OX-P120310	100 x 600mm	1	6	£18.05
OX-P120312	120 x 600mm	1	6	£22.75

PRO MIXING PADDLE M14 THREAD

FEATURES

- Negative Helix/M14 Thread end
- Chrome Plates, durable, high quality Steel
- For mixing acrylic render with grit, thick paint etc
- use on medium viscosity materials



Product Code	Size	Order Qty	Box Qty	List Price
OX-P120435	135 x 650mm	1	6	£37.97

PRO SDS PLUS M14 (F) ADAPTOR

FEATURES

- Converts M14 thread to a SDS Plus fitting
- Enables quick and easy conversion of M14 threaded paddle to be used with SDS drill



Product Code	Size	Order Qty	Box Qty	List Price
OX-P122101	for M14	1	25	£7.95

PRO 5 ROW WATER BRUSH

FEATURES

- Ideal for flicking water onto the wall to liven up the plaster
- White Tampico fibre bristles
- Round wooden handle pinned and glued for secure attachment
- Bristles set securely into hardwood block



Product Code	Size	Order Qty	Box Qty	List Price
OX-P060105	-	1	12	£12.79



SECTION 07

ULTIMATE PLASTERING TOOLS



PRO ULTRAFLEX FINISHING TROWEL

FEATURES

- Ultra flexible trowel for a perfect finish
- Lightweight fully fastened shank for superior balance and strength
- Unique twin blade technology for ultimate flexibility
- 0.3mm Ultra flexible stainless steel blade
- Rounded corners to ensure a smooth finish
- Ergonomic soft grip handle



Product Code	Size	Order Qty	Box Qty	List Price
OX-P530111	280 x 110mm/11"	1	1	£45.61
OX-P530114	355 x 110mm/14"	1	1	£49.53
OX-P530116	405 x 110mm/16"	1	1	£53.44
OX-P530118	455 x 110mm/18"	1	1	£63.89

PRO ULTRAFLEX SMALL TROWEL

FEATURES

- Ultra flexible trowel for a perfect finish
- Lightweight fully fastened shank for superior balance and strength
- Unique twin blade technology for ultimate flexibility
- 0.3mm Ultra flexible stainless steel blade
- Rounded corners to ensure a smooth finish
- Ergonomic soft grip handle



Product Code	Size	Order Qty	Box Qty	List Price
OX-P532608	200 x 80mm/8"	1	1	£39.22

PRO SEMIFLEX STAINLESS STEEL TROWEL

FEATURES

- Semi flexible trowel for a perfect finish, also suitable for laying on



Product Code	Size	Order Qty	Box Qty	List Price
OX-P532514	355 x 125mm/14"	1	1	£49.53
OX-P532516	405 x 125mm/16"	1	1	£53.44

PRO SEMIFLEX PLASTIC FINISHING TROWEL

FEATURES

- Replaceable plastic blade system
- Light weight shank design
- Ergonomic soft grip handle



CHECK OUT THE YOUTUBE TUTORIAL HERE

Product Code	Size	Order Qty	Box Qty	List Price
OX-P532414	355 x 138mm/14"	1	1	£51.27
OX-P532416	405 x 138mm/16"	1	1	£52.92
OX-P532418	455 x 138mm/18"	1	1	£60.12
OX-P532420	505 x 138mm/20"	1	1	£63.37

REPLACEABLE PLASTIC BLADE – 2 PACK

Product Code	Size	Order Qty	Box Qty	List Price
OX-P532714	355 x 138mm/14"	1	1	£27.45
OX-P532716	405 x 138mm/16"	1	1	£29.40
OX-P532718	455 x 138mm/18"	1	1	£31.36
OX-P532720	505 x 138mm/20"	1	1	£33.32



PRO SPEEDSKIM – ST (PLASTERING & RENDERING)



FEATURES

- Speedskim® is a revolutionary tool system designed to increase meterage output and enhance quality of finish – at the same time significantly reducing the harmful effects of fatigue & RSI
- Flattening, finishing & ruling off
- Compatible with all gypsum based plasters (hand and spray applied), traditional sand & cement renders and insulated rendering systems
- Complete with integral blade guard



CHECK OUT THE YOUTUBE TUTORIAL HERE

Product Code	Size	Order Qty	Box Qty	List Price
OX-P530945	450mm	1	14	£48.06
OX-P530960	600mm	1	14	£54.40
OX-P530990	900mm	1	14	£61.49
OX-P530912	1200mm	1	14	£69.74
OX-P530918	1800mm	1	5	£105.12

*Speedskim replacement end caps OX-P536802 available - please enquire.

REPLACEMENT BLADE

- Complete with integral blade guard and spare end caps

Product Code	Size	Order Qty	Box Qty	List Price
OX-P531245	450mm	1	4	£21.14
OX-P531260	600mm	1	4	£22.64
OX-P531290	900mm	1	4	£24.73
OX-P531212	1200mm	1	4	£26.66
OX-P531218	1800mm	1	5	£34.69

- Pro Pole Attachment available



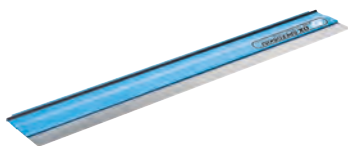

PRO SPEEDSKIM SF (FINE FINISHING & DRYWALL)

FEATURES

- Speedskim® is a revolutionary tool system designed to increase meterage output and enhance quality of finish – at the same time significantly reducing the harmful effects of fatigue & RSI
- Ultra-fine 0.3mm stainless steel blade
- Fine finishing of plaster, drywall & tape & jointing
- Compatible with all gypsum based finishing plasters (hand and spray applied), jointing systems and compounds
- Complete with integral blade guard

Product Code	Size	Order Qty	Box Qty	List Price
OX-P531030	300mm	1	14	£44.37
OX-P531045	450mm	1	14	£53.13
OX-P531060	600mm	1	14	£62.13
OX-P531090	900mm	1	14	£81.03
OX-P531012	1200mm	1	14	£91.17

*Speedskim replacement end caps OX-P536802 available - please enquire.

REPLACEMENT BLADE

- Complete with integral blade guard and spare end caps

Product Code	Size	Order Qty	Box Qty	List Price
OX-P531330	300mm	1	14	£21.65
OX-P531345	450mm	1	14	£26.49
OX-P531360	600mm	1	14	£29.00
OX-P531390	900mm	1	14	£32.65
OX-P531312	1200mm	1	14	£36.28

PRO SPEEDSKIM PF (FINE FINISHING & DRYWALL)

FEATURES

- Speedskim® is a revolutionary tool system designed to increase meterage output and enhance quality of finish – at the same time significantly reducing the harmful effects of fatigue & RSI
- Thin 1mm lightweight plastic blade for an excellent finish
- Fine finishing of plaster, drywall & tape & jointing
- Compatible with all gypsum based finishing plasters (hand and spray applied), Jointing systems and compounds
- Complete with integral blade guard

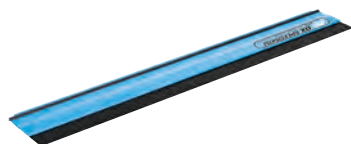

Product Code	Size	Order Qty	Box Qty	List Price
OX-P532945	450mm	1	14	£53.13
OX-P532960	600mm	1	14	£62.13
OX-P532990	900mm	1	14	£81.03
OX-P532912	1200mm	1	14	£91.17

*Speedskim replacement end caps OX-P536802 available - please enquire.

REPLACEMENT BLADE

- Complete with integral blade guard and spare end caps

Product Code	Size	Order Qty	Box Qty	List Price
OX-P533045	450mm	1	14	£26.49
OX-P533060	600mm	1	14	£29.00
OX-P533090	900mm	1	14	£32.65
OX-P533012	1200mm	1	14	£36.28

PRO SPEEDSKIM RE (RENDERING)

FEATURES

- The notched rendering blade from Speedskim® – complementing its award winning range
- Trapezoid profile
- Keys all base coats including: coloured, silicone based, monocouche and also traditional sand and cement render systems
- Speeds up the rendering process by delivering an even thickness to base coats – resulting in flatter faster finish
- Significantly reduces the harmful effects of fatigue & RSI
- Tough, high-grade 0.7mm Sheffield stainless steel blade
- Fully interchangeable



Product Code	Size	Order Qty	Box Qty	List Price
OX-P534245	450mm	1	14	£59.60
OX-P534260	600mm	1	14	£69.10
OX-P534290	900mm	1	14	£93.76

*Speedskim replacement end caps OX-P536802 available - please enquire.

REPLACEMENT BLADE

- Complete with integral blade guard and spare end caps



Product Code	Size	Order Qty	Box Qty	List Price
OX-P534345	450mm	1	14	£31.69
OX-P534360	600mm	1	14	£36.78
OX-P534390	900mm	1	14	£44.37

PRO SPEEDSKIM POLE ATTACHMENT

FEATURES

- Fully compatible with all standard professional 'threaded' extension poles
- Constructed from 'tough glass filled' nylon
- Compatible with all sizes of Speedskim



Product Code	Size	Order Qty	Box Qty	List Price
OX-P531501	-	1	32	£25.89

ULTIMATE INTERNAL CORNER TROWEL

FEATURES

- Flexible stainless steel blade with strong aluminium mounting
- Flexes for perfect 90° corners
- Curved corners to eliminate lines in plaster



Product Code	Size	Order Qty	Box Qty	List Price
OX-P536590	90°	1	6	£17.95
OX-P536410	103°	1	6	£17.95

TRADE PLASTIC FINISHING TROWEL

FEATURES

- Ultra flexible plastic blade for the perfect finish
- Comfortable soft grip handle



Product Code	Size	Order Qty	Box Qty	List Price
OX-T531714	355 x 140mm/14"	1	6	£19.85
OX-T531716	405 x 140mm/16"	1	6	£23.03
OX-T531718	455 x 140mm/18"	1	6	£28.00

SECTION 08

CONCRETING TOOLS





PRO POINTED FLOORING TROWEL

FEATURES

- DURAGRIP handle with soft grip
- Stainless steel blade
- High grade and flexible blade
- Heavy duty fully riveted aluminium shank
- Stainless steel rivets for holding the blade, shank and handle together for unsurpassed strength

Product Code	Size	Order Qty	Box Qty	List Price
OX-P018716	115 x 405mm/16"	1	6	£31.59
OX-P018718	115 x 450mm/18"	1	6	£39.27



PRO CEMENT FINISHING TROWEL

FEATURES

- DURAGRIP handle with soft grip
- Stainless steel blade
- High grade and flexible blade
- Heavy duty fully riveted aluminium shank
- Stainless steel rivets for holding the blade, shank and handle together for unsurpassed strength

Product Code	Size	Order Qty	Box Qty	List Price
OX-P018814	120 x 350mm/14"	1	6	£34.69
OX-P018816	115 x 405mm/16"	1	6	£37.85



PRO POOL FINISHING TROWEL

FEATURES

- Heavy duty aluminium shank
- DURAGRIP handle
- Stainless steel rivets holds the blade, shank and handle together with unsurpassed strength
- High grade stainless steel blade

Product Code	Size	Order Qty	Box Qty	List Price
OX-P015818	110 x 450mm /4½" x 17 ½"	1	4	£39.61



PRO DOUBLE HANDLE STAINLESS STEEL RESIN TROWEL

FEATURES

- Rounded ends for smoothing out imperfections for the perfect finish
- Features dual handle for greater control and improved usability on the job site
- Stainless steel blade for durability and resistance to rust
- Manufactured from high quality steel
- DURAGRIP handle with soft grip for comfort during use
- Specialist trowel for resin bound gravel applications
- Stainless steel rivetted shank for increased strength

Product Code	Size	Order Qty	Box Qty	List Price
OX-P535618	110 x 450mm	1	24	£43.43



PRO MAGNESIUM FLOAT

FEATURES

- Heavy duty magnesium blade
- Bevelled ends and rounded float
- Soft grip handle for comfort

Product Code	Size	Order Qty	Box Qty	List Price
OX-P017012	300mm/12"	1	6	£21.00
OX-P017016	400mm/16"	1	4	£27.00
OX-P017020	500mm/20"	1	6	£31.00



PRO SPINNER FLOAT

FEATURES

- High grade stainless steel dished design
- Reversible DURAGRIP handle

Product Code	Size	Order Qty	Box Qty	List Price
OX-P014112	120 x 290mm	1	4	£16.00
OX-P014114	145 x 215mm	1	6	£15.00



PRO NARROW EDGER 75 X 180MM

FEATURES

- High grade stainless steel blade
- Riveted handle support
- DURAGRIP handle for comfort

Product Code	Description	Order Qty	Box Qty	List Price
OX-P014406	75 x 180mm, 6mm (R), 12mm (D)	1	6	£20.01
OX-P014410	75 x 180mm, 10mm (R), 19mm (D)	1	4	£20.20



PRO MEDIUM EDGER 100 X 180MM

FEATURES

- High grade stainless steel blade
- Riveted handle support
- DURAGRIP handle for comfort

Product Code	Description	Order Qty	Box Qty	List Price
OX-P014506	100 x 180mm, 6mm (R), 14mm (D)	1	6	£19.54
OX-P014510	100 x 180mm, 10mm (R), 14mm (D)	1	4	£19.88
OX-P014519	100 x 180mm, 19mm (R), 19mm (D)	1	6	£20.84



PRO EXTRA WIDE EDGER 145 X 215MM

FEATURES

- High grade stainless steel blade
- Riveted handle support
- DURAGRIP handle for comfort

Product Code	Description	Order Qty	Box Qty	List Price
OX-P014910	145 x 215mm, 10mm (R), 12mm (D)	1	6	£23.71
OX-P014912	145 x 215mm, 12mm (R), 24mm (D)	1	6	£24.09
OX-P014916	145 x 215mm, 16mm (R), 24mm (D)	1	4	£24.51
OX-P014925	145 x 215mm, 25mm (R), 24mm (D)	1	6	£24.92



PRO GROOVER 90 X 180MM

FEATURES

- High grade stainless steel blade
- DURAGRIP handle for comfort

Product Code	Size	Order Qty	Box Qty	List Price
OX-P012510	90 x 180mm Groove 4.8mm(W), 10mm(D)	1	6	£31.98

PRO CONCRETE SCREED WITH VIAL

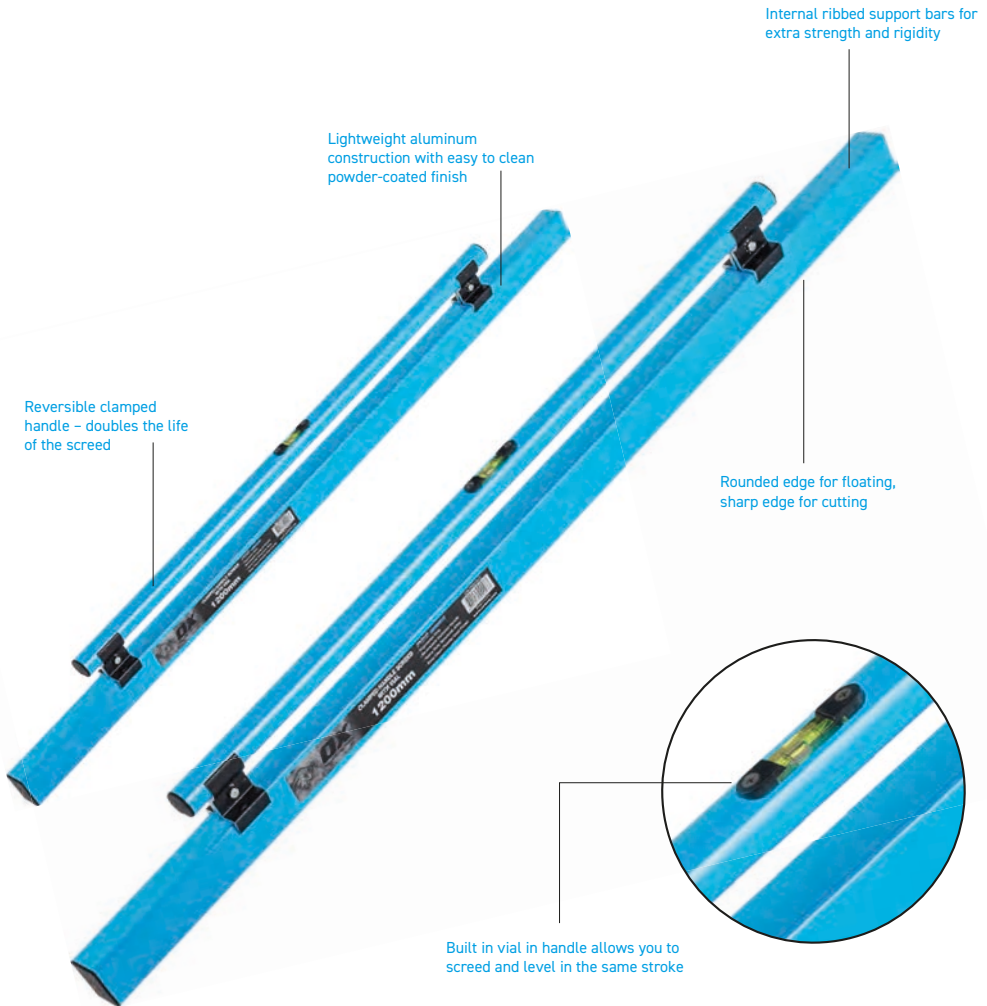

Product Code	Size	Order Qty	Box Qty	List Price
OX-P021312	1200mm/48"	1	8	£68.48
OX-P021318	1800mm/72"	1	8	£85.60

PRO ALUMINIUM BULLFLOAT - WITH TELESCOPIC HANDLE

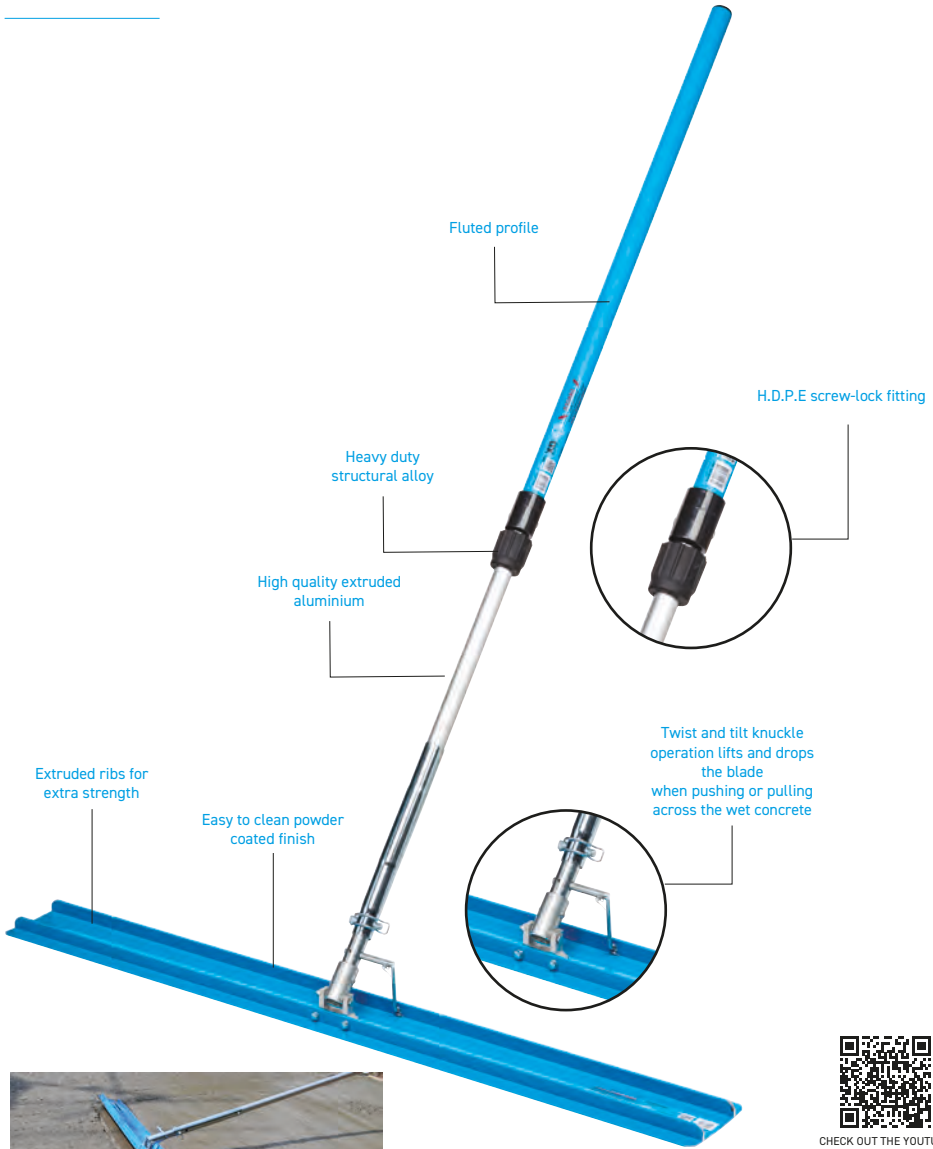

CHECK OUT THE YOUTUBE TUTORIAL HERE

Product Code	Size	Order Qty	Box Qty	List Price
OX-P536924	Bullfloat 1200mm with handle 1300 - 2400mm	1	4	£159.95



PRO ALUMINIUM CONCRETE RAKE

FEATURES

- 1500mm long handle with soft grip
- Braced for additional strength
- Aluminium construction - powder coated

Product Code	Description	Order Qty	Box Qty	List Price
OX-P016302	100 x 500mm	1	4	£54.32

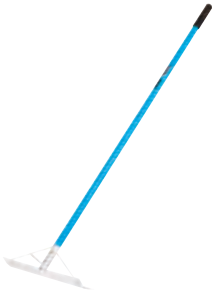

PRO ALUMINIUM CONCRETE RAKE - WITH HOOK

FEATURES

- Braced for additional strength
- With 8mm diameter hook for lifting rebar
- 1500mm long handle with soft grip



CHECK OUT THE YOUTUBE TUTORIAL HERE

Product Code	Description	Order Qty	Box Qty	List Price
OX-P016303	100 x 500mm	1	4	£55.68



TRADE LIGHTWEIGHT EXTRUSION RAKE

FEATURES

- Lightweight for ease of use
- Extruded rake plate
- 45 degree edge angle
- 1500mm long handle with soft grip

Product Code	Description	Order Qty	Box Qty	List Price
OX-T016301	100 x 500mm	1	4	£42.35



PRO WIDE END CUTTING NIPPERS

FEATURES

- PVC Firm grip handle
- Drop forged from high quality carbon steel
- Individually hardened

Product Code	Description	Order Qty	Box Qty	List Price
OX-P230420	200mm/8"	1	6	£29.17

SECTION 09

TILING TOOLS



PRO NOTCH TROWEL

FEATURES

- Carbon steel blade
- Aluminium heavy duty shank
- DURAGRIP handle for comfort



Product Code	Size	Order Qty	Box Qty	List Price
OX-P403206	115 x 280mm - 6mm	1	6	£24.95
OX-P403208	115 x 280mm - 8mm	1	6	£24.95
OX-P403210	115 x 280mm - 10mm	1	6	£24.95
OX-P403212	115 x 280mm - 12mm	1	6	£24.95

TRADE NOTCH TROWEL

FEATURES

- Carbon steel blade
- Ergonomic soft grip handle



Product Code	Size	Order Qty	Box Qty	List Price
OX-T535106	120 x 310mm - 6mm	1	8	£11.00
OX-T535108	120 x 310mm - 8mm	1	8	£11.00
OX-T535110	120 x 310mm - 10mm	1	8	£11.00

TRADE NOTCHED STAINLESS TROWEL

FEATURES

- Stainless steel blade for durability and rust resistance
- Heavy duty riveted aluminium shank for strength and durability DURAGRIP handle for comfort during use



Product Code	Size	Order Qty	Box Qty	List Price
OX-T535706	120 x 310mm - 6mm	1	16	£12.42
OX-T535708	120 x 310mm - 8mm	1	16	£12.42
OX-T535710	120 x 310mm - 10mm	1	16	£12.42
OX-T535712	120 x 310mm - 12mm	1	16	£12.42

PRO SOFT GRIP GROUT FLOAT

FEATURES

- Soft grip ergonomic handle
- Gum rubber black with bevelled edges
- Plastic backer with foam cushion for even pressure



Product Code	Size	Order Qty	Box Qty	List Price
OX-P406224	100 x 240mm	1	12	£16.51

PRO SPONGE FLOAT

FEATURES

- Soft grip handle for ultimate grip and comfort
- 30mm hydro-sponge pad, highly absorbent
- Profiled version for easier cleaning (OX-P140614)

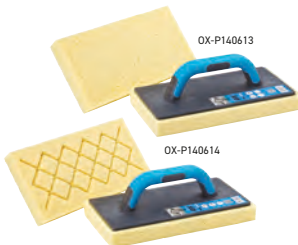

Product Code	Size	Order Qty	Box Qty	List Price
OX-P140613	140 x 280mm	1	24	£13.36
OX-P140614	140 x 280mm	1	24	£22.03



TRADE TILE CLEANER

FEATURES

- Heavy duty 2 component handle
- 2 Grout emulsifying pads included, Black for cleaning and white for polishing

Product Code	Size	Order Qty	Box Qty	List Price
OX-T142525	120 x 250mm	1	6	£19.04



TRADE TILE WASH KIT

FEATURES

- Large 24 litre container made from impact resistant plastic
- 4 lockable swivel wheels and large carry handle for easy moving and positioning around the worksite
- 3 adverse rollers on sliders to allow variable positioning over the container which allow optimum ringing of excess water from the sponge float
- Removable plastic grid on stilts for easy and effective rinsing of the sponge float with plenty of clearance to allow for build-up of excess grout
- Internal fill line to indicate optimum water height



CHECK OUT THE YOUTUBE TUTORIAL HERE

Product Code	Size	Order Qty	Box Qty	List Price
OX-T140424	24l	1	6	£59.49



PRO TILE NIPPERS

FEATURES

- Heavy duty large blade nippers for ceramic tiles
- Tungsten carbide tipped jaws
- Soft grip ergonomic handle for extreme comfort

Product Code	Size	Order Qty	Box Qty	List Price
OX-P153080	200mm/8"	1	5	£18.34



PRO GROUT REMOVER

FEATURES

- Tungsten carbide tipped blade
- Ergonomic body and grip - with blade storage compartment in the hilt

Product Code	Size	Order Qty	Box Qty	List Price
OX-P130201	-	1	72	£9.26



PRO GROUT REMOVER BLADE

FEATURES

- Tungsten carbide tipped blade
- Suits OX-P130201-Pro Grout Remover
- 50mm

Product Code	Size	Order Qty	Box Qty	List Price
OX-P139801	-	1	100	£2.90



DIAMOND HAND POLISHING PADS

FEATURES

- Used for the smoothing of ceramic and porcelain tile edges
- Hard wearing synthetic diamond surface
- Comfortable foam grip
- Use wet or dry

Product Code	Size	Order Qty	Box Qty	List Price
OX-DHPP-60	-	1	10	£16.00
OX-DHPP-200	-	1	10	£16.00
OX-DHPP-400	-	1	10	£16.00
OX-DHPP-600	-	1	10	£16.00



- Set with 100 wedges and 100 x13mm spacers + Pliers

PRO TILE LEVEL SYSTEM WEDGE & SPACER SET

FEATURES

- Aligns tiles of different thicknesses
- Holds securely until adhesive has set
- Ensures a level surface. 100% parallel, symmetrical joint system
- Eliminates possibilities of lippage between tiles
- Wedges are reusable
- Precise, fast and easy to use
- Suitable for DIY and professional tile layers

Product Code	Size	Order Qty	Box Qty	List Price
OX-P161811	1mm x 13mm spacers	1	20	£45.14
OX-P161812	2mm x 13mm spacers	1	20	£45.14
OX-P164024	3mm x 13mm spacers	1	5	£48.13
OX-P161815	5mm x 25mm spacers	1	5	£48.13

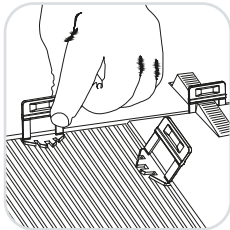

- STEP 1
- Locate the spacers along the tile edge.

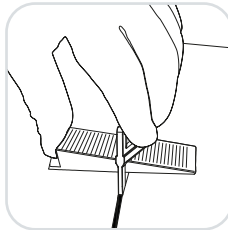

- STEP 2
- Slide wedge into spacer.

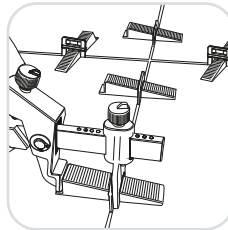

- STEP 3
- Align pliers and compress until tile is level.

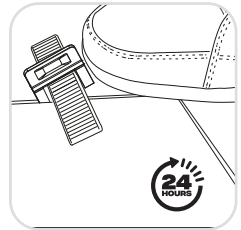

- STEP 4
- Once adhesive begins to go off break away easy snap spacer by kicking or knocking with a mallet.



250
BAG



PRO TILE LEVEL SYSTEM SPACERS 250 PK

PRODUCT CODE	SPACER SIZE	ORDER QTY	BOX QTY	LIST PRICE
OX-P162702	1mm x 13mm	1pk	20	£18.15
OX-P162712	1.5mm x 13mm	1pk	20	£18.15
OX-P162722	2mm x 13mm	1pk </td <td>20</td> <td>£18.15</td>	20	£18.15
OX-P162762	3mm x 13mm	1pk	20	£18.15

Suitable for 2CM thickness tiles

OX-P162732	2mm x 22mm (for tile thickness 12-20mm)	1pk	12	£21.77
OX-P162772	3mm x 22mm (for tile thickness 12-20mm)	1pk	12	£21.77
OX-P162782	4mm x 22mm (for tile thickness 12-20mm)	1pk	12	£21.77
OX-P162792	5mm x 25mm (for tile thickness 12-20mm)	1pk	12	£21.77

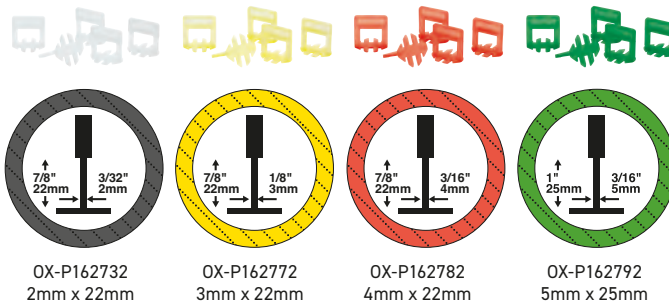
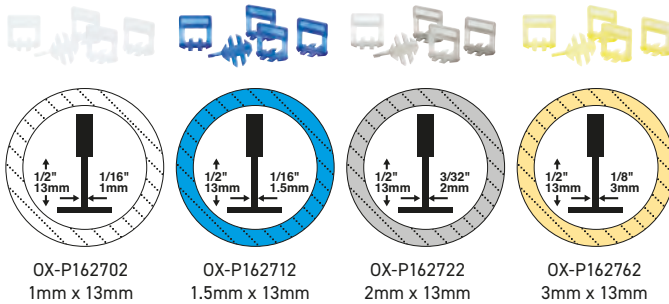



100
BAG

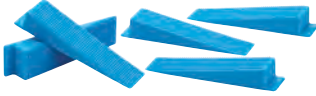

PRO WEDGES BAG 100PCS

FEATURES

- Wedges have saw-shaped teeth to be adjusted to the cross-head precisely
- Round base so not to damage ceramics
- Supplied in bag of 100
- Wedges are reusable

Product Code	Size	Order Qty	Box Qty	List Price
OX-P161810	-	1	16	£15.83



250
BAG



TRADE CROSS SHAPED TILE SPACERS

FEATURES

- Durable tile spacers to help space tiles evenly to give professional finish
- Extra long legs
- 250 pcs per bag

Product Code	Size	Order Qty	Box Qty	List Price
OX-T160902	2mm	1	250	£3.00
OX-T160903	3mm	1	250	£3.00
OX-T160904	4mm	1	250	£3.00
OX-T160905	5mm	1	250	£3.00



500
BAG

TRADE WEDGE SHAPED TILE SPACERS

FEATURES

- Strong & durable plastic tile wedges
- 500 pcs per bag

Product Code	Size	Order Qty	Box Qty	List Price
OX-T160605	5mm	1	500	£6.00



PRO WEDGE PLIERS

FEATURES

- Ergonomically designed handle for comfort during use
- Strong polymer construction
- Adjustable scale
- Adjuster screw to moderate pressure depth
- Steel reinforced pliers core for strength

Product Code	Size	Order Qty	Box Qty	List Price
OX-P161801	-	1	3	£17.01

SECTION 10

STRIKING AND DEMOLITION TOOLS



PRO CLAW HAMMER

FEATURES

- Non-slip grip handle with shock reduction
- Precision balanced
- Forged, one piece steel construction
- High quality steel for durability



CHECK OUT THE YOUTUBE TUTORIAL HERE

Product Code	Size	Order Qty	Box Qty	List Price
OX-P080116	450g/16oz	1	4	£32.72
OX-P080120	560g/20oz	1	4	£34.30
OX-P080124	680g/24oz	1	4	£40.68

PRO STRAIGHT CLAW HAMMER

FEATURES

- Non-slip grip handle with shock reduction
- Precision balanced
- Forged, one piece steel construction
- High quality steel for durability



CHECK OUT THE YOUTUBE TUTORIAL HERE

Product Code	Size	Order Qty	Box Qty	List Price
OX-P082920	560g/20oz	1	4	£34.30

PRO FRAMING HAMMER

FEATURES

- Straight claw hammer designed for frame work
- Long handle for greater impact
- Non-slip grip handle with shock reduction
- Forged, one piece steel construction
- Precision balanced



CHECK OUT THE YOUTUBE TUTORIAL HERE

Product Code	Size	Order Qty	Box Qty	List Price
OX-P082328	790g/28oz	1	4	£47.04

PRO DRYWALL HAMMER

FEATURES

- Crowned, scored hammer head to reduce the chance of impact marks on plasterboard
- Cutaway and notched cutting blade for withdrawing nails and cutting laths
- Non-slip grip handle with shock reduction



CHECK OUT THE YOUTUBE TUTORIAL HERE

Product Code	Size	Order Qty	Box Qty	List Price
OX-P082614	400g/14oz	1	4	£39.08

PRO BRICK HAMMER

FEATURES

- Accurately ground chisel end for clean cutting
- Non-slip grip handle with shock reduction
- Forged, one piece steel construction
- Precision balanced



CHECK OUT THE YOUTUBE TUTORIAL HERE

Product Code	Size	Order Qty	Box Qty	List Price
OX-P082424	680g/24oz	1	4	£35.90



PRO FIBREGLASS HANDLE CLAW HAMMER

FEATURES

- Fibreglass shaft with an injection moulded grip
- Non-slip grip with shock reduction
- Precision balanced



CHECK OUT THE YOUTUBE TUTORIAL HERE

Product Code	Size	Order Qty	Box Qty	List Price
OX-P081616	450g/16oz	1	6	£16.55

TRADE FIBREGLASS CLAW HAMMER

FEATURES

- Lightweight feel and perfect balance
- Curved head ideal for extracting nails
- Hardened & tempered steel head
- Unique OX fibreglass handle
- Reduces vibration
- Suitable for a variety of tasks
- Shock absorbent properties
- Non-slip ergonomically designed soft grip handle



Product Code	Size	Order Qty	Box Qty	List Price
OX-T081216	450g/16oz	1	6	£11.80
OX-T081220	570g/20oz	1	6	£12.31

TRADE CLAW HAMMER

FEATURES

- Heat treated carbon steel head
- Polished head with laser marked weight
- Textured grip



Product Code	Size	Order Qty	Box Qty	List Price
OX-T082820	570g/20oz	1	4	£19.09

TRADE HICKORY HANDLE CLAW HAMMER

FEATURES

- Premium quality genuine American hickory handle
- Forged high quality steel head
- Polished head with laser marked weight



Product Code	Size	Order Qty	Box Qty	List Price
OX-T085116	450g/16oz	1	4	£14.41



PRO CLUB HAMMER

FEATURES

- Forged, one piece steel construction
- Non-slip grip handle with shock reduction
- High quality steel for durability

Product Code	Size	Order Qty	Box Qty	List Price
OX-P082703	1.3kg/3lb	1	4	£38.00
OX-P082704	1.8kg/4lb	1	4	£40.00



TRADE FIBREGLASS CLUB HAMMER

FEATURES

- Hardened high quality steel
- Extremely strong fibreglass handle

Product Code	Size	Order Qty	Box Qty	List Price
OX-T081302	1.1kg/2.5lb	1	4	£14.66
OX-T081304	1.8kg/4lb	1	4	£18.97



PRO HICKORY HANDLE CLUB HAMMER

FEATURES

- Hardened high quality steel
- Genuine hickory handle

Product Code	Size	Order Qty	Box Qty	List Price
OX-P081102	1.1kg/2.5lb	1	4	£19.14
OX-P081104	1.8kg/4lb	1	4	£23.29



TRADE COMBINATION RUBBER MALLET

FEATURES

- Standard black face for general work
- Semi hard white face that will not mark or discolour surfaces
- Strong & light fibreglass handle
- Comfortable grip

Product Code	Size	Order Qty	Box Qty	List Price
OX-T081916	450g/16oz	1	6	£12.77
OX-T081924	680g/24oz	1	6	£15.94
OX-T081932	907g/32oz	1	6	£19.14



CHECK OUT THE YOUTUBE TUTORIAL HERE



PRO WHITE RUBBER MALLET

FEATURES

- Quality, durable rubber mallet

Product Code	Size	Order Qty	Box Qty	List Price
OX-P081816	450g/16oz	1	6	£7.35
OX-P081824	680g/24oz	1	6	£9.41
OX-P081832	907g/32oz	1	6	£11.82



TRADE BLACK RUBBER MALLET

FEATURES

- Quality, durable rubber mallet

Product Code	Size	Order Qty	Box Qty	List Price
OX-T081716	450g/16oz	1	6	£5.11
OX-T081724	680g/24oz	1	6	£6.37
OX-T081732	907g/32oz	1	6	£8.14



TRADE FIBREGLASS SLEDGE HAMMER

FEATURES

- Hardened high quality steel
- Extremely strong fibreglass handle
- Ergonomic tough rubber grip collar

Product Code	Size	Order Qty	Box Qty	List Price
OX-T081507	3.2kg/7lb	1	4	£36.77
OX-T081510	4.5kg/10lb	1	4	£42.54
OX-T081514	6.3kg/14lb	1	2	£54.15



PRO HICKORY HANDLE SLEDGE HAMMER

FEATURES

- Hardened high quality steel
- Genuine hickory handle
- Rubber collar for strike protection

Product Code	Size	Order Qty	Box Qty	List Price
OX-P081407	3.2kg/7lb	1	2	£47.50
OX-P081410	4.5kg/10lb	1	2	£54.00
OX-P081414	6.3kg/14lb	1	2	£65.00



PRO FORGED STEEL HATCHET

FEATURES

- Pre sharpened blade for fast precise cuts
- One piece forged steel construction
- High quality carbon steel for durability
- Precision balanced
- Non-slip soft grip ergonomic comfort handle
- Notch for nail removal
- Blunt face for striking
- Thin neck for vibration reduction

Product Code	Size	Order Qty	Box Qty	List Price
OX-P086420	570g/20oz	1	4	£35.72



PRO HANDY BAR

FEATURES

- Heat treated, forged steel
- For pulling, lifting or prying
- Powder coated to provide maximum resistance to rusting

Product Code	Size	Order Qty	Box Qty	List Price
OX-P093015	380mm/15"	1	8	£13.72



PRO HEAVY DUTY WRECKING BAR

FEATURES

- Forged high carbon steel for incredible strength
- Slotted claw for pulling & prying nails
- Impressive powder coated finish

Product Code	Size	Order Qty	Box Qty	List Price
OX-P083524	600mm/24"	1	10	£19.77



TRADE WRECKING BAR VARIOUS SIZES

FEATURES

- Solid steel wrecking bar
- Forged high carbon steel - one piece

Product Code	Size	Order Qty	Box Qty	List Price
OX-T091012	300mm/12"	1	10	£4.77
OX-T091018	450mm/18"	1	10	£7.18
OX-T091024	600mm/24"	1	10	£10.38
OX-T091030	750mm/30"	1	10	£13.10
OX-T091036	900mm/36"	1	10	£15.47



PRO CLAW BAR

FEATURES

- Unique hammer head
- Multi-functional claw bar for striking, prying & pulling
- Comfort non-slip grip handle
- Polished bevelled claw for better access

Product Code	Size	Order Qty	Box Qty	List Price
OX-P083010	250mm/10"	1	6	£18.07
OX-P083012	300mm/12"	1	6	£21.82



PRO MOULDING BAR

FEATURES

- Unique hammer head
- Multi-functional moulding bar with extra wide chisel blade
- Comfort non-slip grip handle
- Polished bevelled claw for better access

Product Code	Size	Order Qty	Box Qty	List Price
OX-P083110	250mm/10"	1	6	£18.07



TRADE DEMOLITION BAR

FEATURES

- Ideal for ripping up floorboards
- Perfect for lifting heavy objects like slabs and flooring
- Double crowbar design
- Forged steel construction
- Heat treated for extra durability
- Heavy duty
- Soft grip handle

Product Code	Size	Order Qty	Box Qty	List Price
OX-T093212	1240mm	1	1	£37.45



PRO BRICK CHISEL VARIOUS SIZES

FEATURES

- Forged chrome vanadium steel
- Dual hand guard
- Soft grip handle
- For cutting & splitting of Bricks & Masonry



CHECK OUT THE YOUTUBE TUTORIAL HERE

Product Code	Size	Order Qty	Box Qty	List Price
OX-P092303	3" x 8 1/2"	1	5	£19.97
OX-P092304	4" x 8 1/2"	1	5	£21.70



PRO ELECTRICIAN'S CHISEL 57 X 254MM

FEATURES

- Forged chrome vanadium steel
- Dual hand guard
- Soft grip handle



CHECK OUT THE YOUTUBE TUTORIAL HERE

Product Code	Size	Order Qty	Box Qty	List Price
OX-P092002	57 X 254mm	1	5	£19.14



PRO FLOOR CHISEL 76 X 279MM

FEATURES

- Forged chrome vanadium steel
- Dual hand guard
- Soft grip handle

Product Code	Size	Order Qty	Box Qty	List Price
OX-P092103	76 X 279mm	1	5	£21.70



PRO COLD CHISEL 25 X 305MM

FEATURES

- Forged chrome vanadium steel
- Dual hand guard
- Soft grip handle



CHECK OUT THE YOUTUBE TUTORIAL HERE

Product Code	Size	Order Qty	Box Qty	List Price
OX-P092401	25 X 305mm	1	5	£19.97



PRO CONCRETE CHISEL 18 X 305MM

FEATURES

- Forged chrome vanadium steel
- Dual hand guard
- Soft grip handle
- For cutting & breaking of Concrete

Product Code	Size	Order Qty	Box Qty	List Price
OX-P092501	18 x 305mm	1	5	£19.97



TRADE BRICK BOLSTER WITH GUARD VARIOUS SIZES

FEATURES

- One piece forged steel for ultimate strength
- Hardened & tempered for durability
- Protection hand guard

Product Code	Size	Order Qty	Box Qty	List Price
OX-T090502	57mm/2 1/4"	1	6	£9.26
OX-T090503	75mm/3"	1	4	£11.64
OX-T090504	100mm/4"	1	4	£13.23



TRADE BRICK BOLSTER VARIOUS SIZES

FEATURES

- One piece forged steel for ultimate strength
- Hardened & tempered for durability

Product Code	Size	Order Qty	Box Qty	List Price
OX-T090902	57mm/2 1/4"	1	5	£7.80
OX-T090903	75mm/3"	1	5	£7.98
OX-T090904	100mm/4"	1	5	£9.58



TRADE COLD CHISEL VARIOUS SIZES

FEATURES

- One piece forged steel for ultimate strength
- Hardened & tempered for durability
- For cutting & shaping metal

Product Code	Size	Order Qty	Box Qty	List Price
OX-T090110	25 X 250mm/1" X 10"	1	6	£7.98
OX-T090112	25 X 300mm/1" X 12"	1	6	£8.93
OX-T090118	25 X 450mm/1" X 18"	1	4	£12.77
OX-T091206	13 X 150mm/1/2" X 6"	1	10	£2.09
OX-T091208	20 X 200mm/3/4" X 8"	1	10	£4.14
OX-T091210	20 X 250mm/3/4" X 10"	1	10	£4.47
OX-T091212	20 X 300mm/3/4" X 12"	1	10	£4.77
OX-T091218	20 X 450mm/3/4" X 18"	1	6	£7.98



TRADE PLUGGING CHISEL 230MM X 6MM

FEATURES

- Steel plugging chisel
- One piece forged steel for ultimate strength

Product Code	Size	Order Qty	Box Qty	List Price
OX-T091106	230mm X 6mm	1	6	£6.69



TRADE DOUBLE ENDED SCUTCH HAMMER - 28OZ

FEATURES

- Hardened high quality steel/strong fibreglass handle
- Takes OX scutch combs in both ends, designed for dressing bricks and masonry

Product Code	Size	Order Qty	Box Qty	List Price
OX-T085028	28oz	1	6	£21.27



PRO SCUTCH COMB HOLDERS

FEATURES

- For detachable stone dressing combs
- Hardened & tempered for durability - high carbon steel

Product Code	Size	Order Qty	Box Qty	List Price
OX-P090310	200 x 25mm/8 x 1"	1	4	£9.58
OX-P090315	200 x 38mm/8 x 1½"	1	4	£13.55



PRO SCUTCH COMBS 4PK

FEATURES

- To fit into a scutch comb holder
- For preparation of surface prior to re-rendering

Product Code	Size	Order Qty	Box Qty	List Price
OX-P080725	25mm	1	10	£5.56
OX-P080738	38mm	1	10	£6.24
OX-P080750	50mm	1	10	£7.18

SECTION 11

PLUMBING & ELECTRICAL TOOLS



PRO POLYZIP™ FLEX PIPE CUTTERS - C1 & C2



FEATURES

- Patented flex technology for multi diameter cutting
- Perfect for most popular plumbing pipes and electrical conduits including most flexible conduits
- Ultra-square cut
- Efficient and precise leaving zero pipe deformation
- Spare blade and safety insert included
- Quick change stainless blade (reversible dual life)
- Zero swarf
- Manufactured in the UK
- UK patented technology

UK & EURO PIPE CUTTING COMPATIBILITY

C1	UK	15mm	20mm	22mm	25mm	28mm
	EURO	16mm	20mm	26mm	-	-
C2	UK	25mm	28mm	35mm	42mm	55mm
	EURO	26mm	32mm	40mm	50mm	-

Product Code	Size	Order Qty	Box Qty	List Price
OX-P563328	15-28mm - C1	1	1	£17.07
OX-P563355	25-55mm - C2	1	1	£23.49
OX-P564002	28mm and 25 - 55mm C1 & C2 (Twinpack)	1	1	£39.95



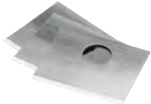

- Replacement blade - 3 pack available



- 4 Pack available (15, 22, 35 & 42mm)

PRO POLYZIP™ PLASTIC PIPE CUTTER

FEATURES

- Fast precision cutting
- Lightweight & easy to use
- Compatible with all popular plastic pipes
- Zero pipe deformation promotes easy insertion of pipe stiffeners
- Zero swarf for professional results on solvent weld & push fit systems



Product Code	Size	Order Qty	Box Qty	List Price
OX-P561915	15mm	1	64	£14.32
OX-P562022	22mm	1	64	£14.87
OX-P562135	35mm (1½")	1	50	£27.06
OX-P562242	42mm (1¾")	1	50	£28.56
OX-P562250	50mm (2")	1	36	£32.68
OX-P562255	55mm (2")	1	36	£34.23
OX-P562404	4 Pack (15, 22, 35 & 42mm)	1	1	£84.82

REPLACEMENT POLYZIP & POLYZIP FLEX BLADES

Product Code	Size	Order Qty	Box Qty	List Price
OX-P562701	Blades (3 Pack)	1	92	£8.07



PRO PVC PIPE CUTTER (16 - 42MM)

FEATURES

- V Shape blade for immediate penetration.
- Exceptionally sharp stainless steel blade.
- Cuts through any MUPVC/PVC pipe effortlessly without kinking or shattering

Product Code	Size	Order Qty	Box Qty	List Price
OX-P449542	16 - 42mm	1	12	£45.00
OX-P449701	Replacement Blade	1	25	£15.00



PRO RATCHET COPPER PIPE CUTTER

FEATURES

- Internal cutting mechanism with ergonomic surround which fits comfortably in the hand

Product Code	Size	Order Qty	Box Qty	List Price
OX-P449615	15mm	1	12	£24.00
OX-P449622	22mm	1	12	£26.00

REPLACEMENT CUTTING WHEELS - 2 PACK

Product Code	Size	Order Qty	Box Qty	List Price
OX-P440102	-	1	200	£9.50



PRO COPPER PIPE CUTTER

FEATURES

- Fast clean cutting, ideal for use in confined spaces

Product Code	Size	Order Qty	Box Qty	List Price
OX-P448515	15mm	1	12	£14.72
OX-P448522	22mm	1	12	£16.03
OX-P448528	28mm	1	12	£18.52

REPLACEMENT CUTTING WHEELS - 2 PACK

Product Code	Size	Order Qty	Box Qty	List Price
OX-P440102	-	1	200	£9.50

PRO ADJUSTABLE TUBE CUTTER

FEATURES

- Heavy duty telescopic tube cutter
- Smooth and accurate telescopic adjustment
- Cuts tubes from 6 - 35mm
- Deburring attachment for removing swarf
- Cuts copper, brass, aluminium and thin walled steel tubes



Product Code	Size	Order Qty	Box Qty	List Price
OX-P448635	-	1	25	£39.50

REPLACEMENT CUTTING WHEELS - 2 PACK

Product Code	Size	Order Qty	Box Qty	List Price
OX-P560302	-	1	200	£9.50

PRO ULTRA-WIDE JAW ADJUSTABLE WRENCH

FEATURES

- Very slim head for access into tight spaces
- Measurement scale on jaw



CHECK OUT THE YOUTUBE TUTORIAL HERE



Product Code	Size	Jaw	Order Qty	Box Qty	List Price
OX-P324606	152mm/6"	34mm	1	10	£23.76
OX-P324608	200mm/8"	38mm	1	5	£28.52
OX-P324610	250mm/10"	50mm	1	5	£36.43
OX-P324612	300mm/12"	60mm	1	5	£50.69

PRO ADJUSTABLE WRENCH

FEATURES

- Narrow head design for limited space applications
- Laser marked jaw scale



Product Code	Size	Jaw	Order Qty	Box Qty	List Price
OX-P324506	152mm/6"	24mm	1	6	£12.90
OX-P324508	200mm/8"	29mm	1	6	£15.94
OX-P324510	250mm/10"	33mm	1	6	£19.01



PRO SLIM JAW ADJUSTABLE WRENCH

FEATURES

- Ultra slim head for easy accessibility in confined spaces
- Double ended with a fixed jaw at one end for nuts, bars, screws etc
- Measurement scale on jaw

Product Code	Size	Jaw	Order Qty	Box Qty	List Price
OX-P560208	200mm/8"	32mm	1	6	£39.11



PRO STUBBY ADJUSTABLE WRENCH EXTRA JAW

FEATURES

- Short handled wrench for access in restricted spaces
- 0 - 53mm ultra wide opening slim jaws
- Dipped handle for comfort
- Heavy duty build for long life

Product Code	Size	Jaw	Order Qty	Box Qty	List Price
OX-P560507	180mm/7"	53mm	1	6	£41.16



PRO MINI ADJUSTABLE WRENCH - 100MM/4"

FEATURES

- Precision engineered compact design for manoeuvrability in tight spaces
- Angled head for improved accessibility
- Made from chromium-vanadium steel
- Compact and portable

Product Code	Size	Jaw	Order Qty	Box Qty	List Price
OX-P561004	100mm/4"	17mm	1	10	£16.95



PRO MAX LEVERAGE PLUMBING GRIPS

FEATURES

- Push button release for super fast and accurate adjustment
- Ultimate force distribution from jaws to handle providing incredible grip

Product Code	Size	Order Qty	Box Qty	List Price
OX-P562525	250mm/10"	1	24	£43.04



PRO AUTOMATIC WATERPUMP PLIERS

FEATURES

- Automatic waterpump pliers for fast one hand size adjustment
- Tough chrome vanadium steel
- Double dipped handle for comfort

Product Code	Size	Order Qty	Box Qty	List Price
OX-P326010	250mm/10"	1	10	£26.81
OX-P326012	300mm/12"	1	6	£32.74



PRO WATERPUMP PLIERS

FEATURES

- Adjustable width jaw for grasping & turning
- Tough chrome vanadium steel

Product Code	Size	Order Qty	Box Qty	List Price
OX-P325825	250mm/10"	1	12	£26.42



PRO LOCKING PLIERS

FEATURES

- Quick jaw release lever for ease of opening

Product Code	Size	Order Qty	Box Qty	List Price
OX-P449323	230mm/9"	1	5	£23.66



PRO MULTI ANGLE ALUMINIUM PIPE WRENCH

FEATURES

- Fully adjustable jaw up to 53mm
- Lightweight aluminium handle for strain free all-day use
- 180° Quick action adjustable handle
- Heavy duty construction
- Perfect for use in restricted areas

Product Code	Size	Order Qty	Box Qty	List Price
OX-P560610	250mm/10"	1	6	£57.50



PRO HEAVY DUTY ALUMINIUM SELF LOCKING WRENCH

FEATURES

- OX strength self locking grip
- Grips stainless steel tubes
- Super lightweight aluminium handle

Product Code	Size	Jaw	Order Qty	Box Qty	List Price
OX-P560110	250mm/10"	34mm	1	12	£39.50



PRO STILLSON PATTERN PIPE WRENCH

FEATURES

- Deeply grooved jaws for instant grip and ratcheting action

Product Code	Size	Order Qty	Box Qty	List Price
OX-P441812	300mm/12"	1	6	£25.00
OX-P441814	350mm/14"	1	6	£29.50

PRO OLIVE REMOVAL TOOL 15 & 22MM



FEATURES

- Heavy duty olive removal tool
- Removes an olive from copper pipe without damaging the pipe
- Dipped handles for comfort and grip

Product Code	Size	Order Qty	Box Qty	List Price
OX-P440015	15mm	1	5	£36.59
OX-P440022	22mm	1	5	£38.55

PRO ADJUSTABLE BASIN WRENCH

FEATURES

- Telescopic basin nut wrench
- Reversible Jaw for easy access
- 4 adjustment sizes
- 10 to 32mm Jaw Capacity



Product Code	Size	Order Qty	Box Qty	List Price
OX-P448401	-	1	15	£33.83

TRADE ADJUSTABLE BASIN WRENCH

FEATURES

- Adjustable wrench for taps and basins
- Forged jaw turns 180 degrees for more flexibility



Product Code	Size	Order Qty	Box Qty	List Price
OX-T449201	-	1	12	£10.77

TRADE FIXED BASIN WRENCH 15 - 22MM

FEATURES

- Heavy duty basin wrench
- For fitting back nuts and union nuts of pillar and bath taps behind basins, sinks and baths.
- Jaws machined to fit standard back nuts
- Offset design for easy access behind baths and sinks



Product Code	Size	Order Qty	Box Qty	List Price
OX-T449022	15 - 22mm	1	6	£10.02



PRO HEAVY DUTY IMMERSION SPANNER

FEATURES

- Extra heavy duty immersion wrench
- Cranked head for easy access
- One piece casting for greater strength and power

Product Code	Size	Order Qty	Box Qty	List Price
OX-P449901	-	1	2	£28.10



TRADE IMMERSION SPANNER

FEATURES

- Cranked head for easy access
- Firm non slip grip on immersion heater elements
- High quality steel

Product Code	Size	Order Qty	Box Qty	List Price
OX-T448801	-	1	6	£6.24



BRASS RADIATOR KEYS

FEATURES

- Fits most domestic radiators

Product Code	Size	Order Qty	Box Qty	List Price
OX-T449803	-	1	12	£2.69



TRADE MANHOLE COVER KEYS

FEATURES

- Lifting keys for the easy removal of manhole covers
- Heavy duty iron
- D shaped ends

Product Code	Size	Order Qty	Box Qty	List Price
OX-T449102	-	1	12	£10.65



PRO PLUMBERS PROTECTIVE HEAT MAT

FEATURES

- Resists temperatures up to 1000°C
- Sewn and loop stitched with wire reinforced kevlar flame proof thread for extra long life
- Fully flexible foil back allowing freedom of movement
- Asbestos free

Product Code	Size	Order Qty	Box Qty	List Price
OX-P562901	300 x 210mm	1	30	£28.99

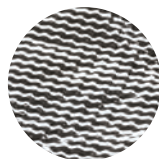



PRO LONG NOSE PLIERS 200MM/8"

FEATURES

- Long nose design
- Used for grasping or bending & cutting
- Induction hardened chrome steel
- Hardened cutting edges

Product Code	Size	Order Qty	Box Qty	List Price
OX-P321620	200mm/8"	1	12	£20.54



PRO BENT LONG NOSE PLIERS 200MM/8"

FEATURES

- Induction hardened chrome steel
- Hardened edges

Product Code	Size	Order Qty	Box Qty	List Price
OX-P321720	200mm/8"	1	12	£21.56



PRO DIAGONAL CUTTING PLIERS 160MM/6"

FEATURES

- Used for cutting with pivot design
- Induction hardened chrome steel
- Hardened edges

Product Code	Size	Order Qty	Box Qty	List Price
OX-P321416	160mm/6"	1	12	£22.02



PRO COMBINATION PLIERS 180MM/7"

FEATURES

- Used for gripping, twisting & cutting
- Induction hardened chrome steel
- Hardened edges

Product Code	Size	Order Qty	Box Qty	List Price
OX-P321318	180mm/7"	1	12	£19.80



PRO WIRE STRIPPER PLIERS 160MM/6"

FEATURES

- Used for stripping up to 10 gauge wire
- Easily adjustable
- Induction hardened chrome steel
- Hardened edges

Product Code	Size	Order Qty	Box Qty	List Price
OX-P321516	160mm/6"	1	12	£23.49



PRO VDE LONG NOSE PLIERS 200MM/8"

FEATURES

- Can be used safely when working on live electrical wires at voltage of up to 1000 volts AC
- Manufactured & tested to exacting European Standards

Product Code	Size	Order Qty	Box Qty	List Price
OX-P323820	200mm/8"	1	12	£26.42



PRO VDE BENT LONG NOSE PLIERS 200MM/8"

FEATURES

- Can be used safely when working on live electrical wires at voltage of up to 1000 volts AC
- Manufactured & tested to exacting European Standards

Product Code	Size	Order Qty	Box Qty	List Price
OX-P323920	200mm/8"	1	12	£28.32



PRO VDE DIAGONAL CUTTING PLIERS 160MM/6"

FEATURES

- Can be used safely when working on live electrical wires at voltage of up to 1000 volts AC
- Manufactured & tested to exacting European Standards

Product Code	Size	Order Qty	Box Qty	List Price
OX-P324116	160mm/6"	1	12	£27.89



PRO VDE COMBINATION PLIERS 180MM/7"

FEATURES

- Can be used safely when working on live electrical wires at voltage of up to 1000 volts AC
- Manufactured & tested to exacting European Standards

Product Code	Size	Order Qty	Box Qty	List Price
OX-P324320	180mm/7"	1	12	£27.89



PRO VDE WIRE STRIPPER PLIERS 160MM/6"

FEATURES

- Can be used safely when working on live electrical wires at voltage of up to 1000 volts AC
- Manufactured & tested to exacting European Standards

Product Code	Size	Order Qty	Box Qty	List Price
OX-P324016	160mm/6"	1	12	£28.60



PRO VDE WATERPUMP PLIERS

FEATURES

- Can be used safely when working on live electrical wires at voltage of up to 1000 volts AC
- Manufactured & tested to exacting European Standards

Product Code	Size	Order Qty	Box Qty	List Price
OX-P324224	250mm/10"	1	12	£35.22

SECTION 12

SITE TOOLSS & ACCESSORIES





TRADE 1/4"DRIVE SOCKET SET 35 PIECE

FEATURES

- Sockets made from chrome vanadium steel with a matt finish
- 72 tooth 1/2" ratchet with reversible function - Includes extension bar 100mm(l), universal joints, standard & deep 1/4" metric sockets, 1/4" bits 25mm (l)
- Bit length is 25mm made from s2 steel

Product Code	Size	Order Qty	Box Qty	List Price
OX-T326735	-	1	8	£49.95



PRO IMPACT BIT SET 11 PIECE

FEATURES

- 11 Piece set: impact bits 25mm x 10, impact magnetic bit holder 60mm x 1
- Includes x8 impact material bits with a black phosphate finish for durability
- Suitable for use with impact drivers
- Impact magnetic bit holder
- Hex shank

Product Code	Size	Order Qty	Box Qty	List Price
OX-P215311	-	10	10	£11.95



PRO IMPACT BIT SET 31 PIECE

FEATURES

- 31 piece set: impact bits 25mm x 30, impact magnetic bit holder 60mm x 1
- Suitable for use with impact drivers
- X8 impact material bits with a black phosphate finish
- Impact magnetic bit holder
- Hex shank

Product Code	Size	Order Qty	Box Qty	List Price
OX-P215431	-	12	12	£19.95



PRO IMPACT DRILL & DRIVE ACCESSORY SET 40 PIECE

FEATURES

- 40 piece set: impact bits 25mm x 24, impact bits 50mm x 8, impact socket adapter 50mm x 1, impact magnetic bit holder 60mm x 1, impact 50mm nut drivers x 3 (8mm, 10mm, 13mm), hss drills with hex shank x 3 3.5mm, 4mm, 5mm
- Suitable for use with impact drivers
- X8 impact material bits with a black phosphate finish
- Impact magnetic bit holder & socket adapter. X3 HSS drill bits
- Hex shank

Product Code	Size	Order Qty	Box Qty	List Price
OX-P21554	-	1	6	£42.00

PRO OXIT – 3 IN 1 ADHESIVE, SEALANT & GAP FILLER

OXIT

OXIT 3 IN 1 PERFORMANCE

FEATURES

- Industrial grab provides a quick fix for many applications
- Industrial super strength
- Bonds in the wet or under water
- Waterproof seal
- Interior/exterior applications
- High UV resistance
- Bonds and seals all materials
- Fast skinning
- Superior high flexibility
- Non-hazardous
- Anti-mould
- Over-paintable



Product Code	Description	Size	Order Qty	Box Qty	List Price
OX-P590201	OXIT Sealant and Adhesive White	290ml	12	12	£9.95
OX-P590202	OXIT Sealant and Adhesive Black	290ml	12	12	£9.95
OX-P590203	OXIT Sealant and Adhesive Anthracite	290ml	12	12	£9.95
OX-P590204	OXIT Sealant and Adhesive Clear	290ml	12	12	£9.95

INCREDIBLY STRONG BOND STRENGTH



SEALS & BONDS UNDER WATER AND IN ALL WEATHERS



MULTI-PURPOSE ALL MATERIALS INTERIOR & EXTERIOR



SUPER FAST SKINNING SPEED



SUPERIOR HIGH FLEXIBILITY





PRO RODLESS SEALANT GUN 400ML

FEATURES

- Internal push rod design for optimised access in tight or hard to reach spaces such as behind sinks, internal cabinets or shower cubicles
- Lightweight reinforced Polycarbon housing for improved ergonomics
- Ergonomically designed handle for comfort during use
- Riveted and reinforced carriage
- Suitable for all cartridges up to 400ml
- Ideal for use with latex & silicone caulks
- Belt hook for easy clip to tool belts

Product Code	Size	Order Qty	Box Qty	List Price
OX-P044914	400ml	1	12	£42.75



PRO DUAL THRUST SEALANT GUN 400ML

FEATURES

- Patented toggle switch to easily change thrust & stroke
- Switchable ratio (12:1/24:1) function to enable easy application of all viscosity adhesives and sealants
- Patented 360° Steel riveted rotating carriage
- Twin heat-treated steel push plates for greater strength
- Impact-resistant Nylon/Fiberglass handle & trigger with TPE rubber over mold
- Smooth thrust action
- Rigid polymer handle for strength and durability
- 1.5mm steel push piston.
- For dispensing up to 400ml cartridges
- Steel pin on underside for puncturing dried caulk

Product Code	Size	Order Qty	Box Qty	List Price
OX-P045440	400ml	1	10	£39.06



PRO HEAVY DUTY SEALANT GUN 400ML

FEATURES

- Heavy duty professional sealant gun, built for ultimate power and durability
- High thrust trigger action with adjustable screw
- Welded and rotating barrel accepts up to 400ml cartridges. Barrel allows rotation to ensure long continuous clean beads with minimal effort
- Ergonomically designed dipped trigger handle, support the hands when applying pressure
- Ideal for outdoor working environments
- Mechanism allows higher force application - ideal for today's 'heavy duty' silicones and sealants
- Fully welded barrel



CHECK OUT THE YOUTUBE TUTORIAL HERE

Product Code	Size	Order Qty	Box Qty	List Price
OX-P044440	400ml	1	12	£29.14

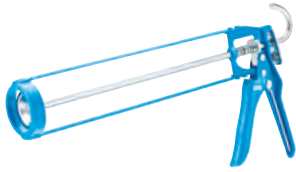

PRO SEALANT GUN 400ML

FEATURES

- Professional sealant gun with highly durable construction
- Free flowing action and quick release trigger
- Built in nozzle cleaning pin
- Tempered steel rod and plate

Product Code	Size	Order Qty	Box Qty	List Price
OX-P041840	400ml	1	24	£11.55

PRO DUAL THRUST SAUSAGE CAULKING GUN 600ML

FEATURES

- Ideal for re-pointing and filling applications
- Patented 360° rotating aluminium barrel
- Easily dismantled for cleaning
- Cartridge capacity 600ml
- Ergonomically designed impact-resistant polymer handle & trigger
- Patented quick fit tool-less plunger system
- Quick switch dual thrust ratio 12:1 & 24:1
- Suitable for low to high viscosity materials
- Supplied with standard & hi flow nozzles



Product Code	Size	Order Qty	Box Qty	List Price
OX-P045560	600ml	1	10	£47.75

PRO SAUSAGE CAULKING GUN 600ML

FEATURES

- Ideal for re-pointing and filling applications
- Patented 360° rotating aluminium barrel
- Easily dismantled for cleaning
- Cartridge capacity 600ml
- Die cast metal handle
- Plunge force 200kg | 2.0kN
- Steel pin on handle for puncturing dried caulk
- Enclosed aluminium anodized barrel
- Suitable for low to medium viscosity materials
- Supplied with standard & hi flow nozzles



Product Code	Size	Order Qty	Box Qty	List Price
OX-P040215	600ml	1	10	£33.65

PRO HAND RIVET GUN

FEATURES

- Heavy duty grade riveter
- Suitable for 2.4, 3.2, 4.0 & 4.8mm rivets
- Compatible with aluminium, steel & stainless-steel rivets
- 4x Nose pieces & 10mm wrench
- CR-MO Steel upper handle with TPR Grip



Product Code	Size	Order Qty	Box Qty	List Price
OX-P316601	-	1	10	£29.50



TRADE HEAVY DUTY 3 WAY STAPLE GUN

FEATURES

- Heavy duty all-metal construction
- Quick jam release button
- Impact power adjustment
- Rust and corrosion resistance surface
- Compatible with heavy duty flat wire staples 4-14mm, U Shape staples 10-12mm & Brad Nails 18ga 10-14mm

Product Code	Size	Order Qty	Box Qty	List Price
OX-T316103	-	1	6	£16.00



PRO 4 IN 1 HEAVY DUTY STAPLE GUN

FEATURES

- Closed view magazine
- High / low power settings
- Lightweight & durable aluminium housing
- Interchangeable left or right belt clip
- Compatible with both light & heavy duty flat wire staples 6-14mm, U Shape staples 10-14mm & Brad Nails 18ga 14-15mm.

Product Code	Size	Order Qty	Box Qty	List Price
OX-P316204	-	1	6	£29.95



PRO HEAVY DUTY HAMMER TACKER

FEATURES

- Heavy duty steel construction with a chrome finish
- Comfortable rubber grip
- Retractable striking edge
- Compatible with heavy duty flat wire staples 6-14mm
- Convenient bottom loading facilitates quick and easy jam clearing

Product Code	Size	Order Qty	Box Qty	List Price
OX-P316301	-	1	2	£26.00



PRO HEAVY DUTY STAPLES - VARIOUS SIZES

FEATURES

- Heavy duty staples manufactured from high quality steel
- Galvanized surface for indoor or outdoor use
- 1 Pack contains 1000 staples
- Various sizes available

Product Code	Size	Order Qty	Box Qty	List Price
OX-P316406	OX Pro Heavy Duty Staples - 6mm	1	40	£2.75
OX-P316408	OX Pro Heavy Duty Staples - 8mm	1	40	£2.95
OX-P316410	OX Pro Heavy Duty Staples - 10mm	1	40	£3.15
OX-P316412	OX Pro Heavy Duty Staples - 12mm	1	40	£3.35

TRADE KNEELING BOARD - 480 X 350MM

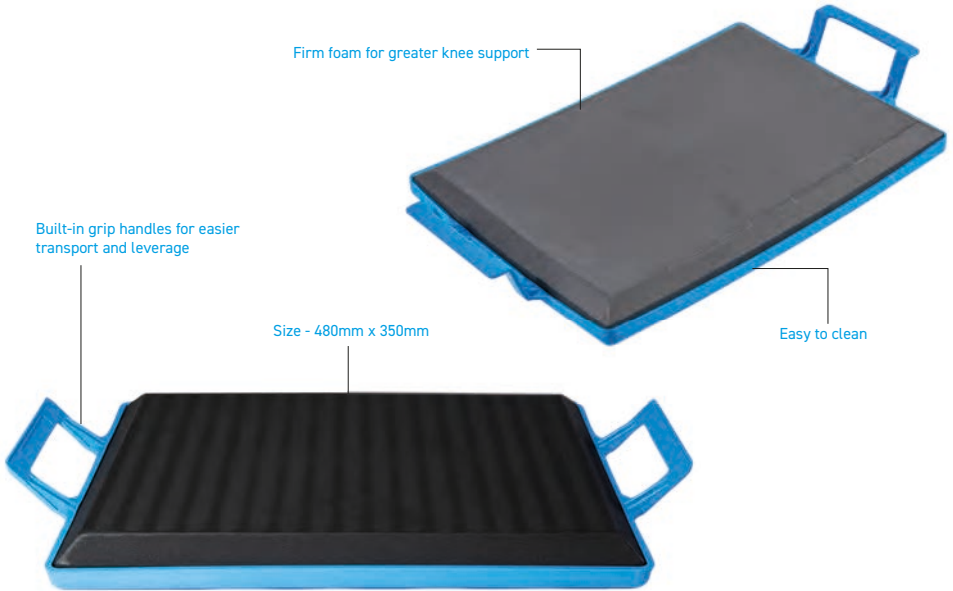

Product Code	Size	Order Qty	Box Qty	List Price
OX-T240300	480 x 350mm	1	10	£25.68





TRADE SOLID FORGED SHOVEL RANGE

FEATURES

- All steel construction for increased strength
- Smooth round wood handle for greater comfort
- 'Y' shape handle structure with optimised space to allow for the largest of hands
- Solid forged steel blade with tapered tip
- Powder coated finish to protect from rust
- Longer shovel shaft designed to maximise reach and increase leverage, also decreasing the risk of strain injury
- Heat treated blade for ultimate strength
- Robust lightweight design

Product Code	Type	Order Qty	Box Qty	List Price
OX-T280301	Taper Mouth	1	5	£29.00
OX-T280401	Trenching Shovel	1	5	£26.75
OX-T280701	Square Mouth	1	5	£29.00
OX-T280601	Draining Shovel	1	5	£31.50
OX-T280501	Cable Laying	1	5	£31.50
OX-T281101	Treaded Digging Shovel	1	5	£31.50



TRADE SOLID FORGED 4 TINES FORK

FEATURES

- Solid forged 4 tines fork
- All steel construction for increased strength
- Smooth round wood handle for greater comfort
- 'Y' shape handle structure with optimised space to allow for the largest of hands
- Powder coated finish to protect from rust
- Longer shovel shaft designed to maximise reach and increase leverage, also decreasing the risk of strain injury
- Robust lightweight design

Product Code	Size	Order Qty	Box Qty	List Price
OX-T281001	-	1	5	£37.45



PRO INSULATED SHOVEL RANGE

FEATURES

- Conforms to BS8020
- Extra wide D-Grip for greater comfort
- Solid forged steel head for strength and durability

Product Code	Type	Order Qty	Box Qty	List Price
OX-P283001	Taper Mouth	1	5	£85.00
OX-P283201	Trenching Shovel	1	5	£85.00
OX-P283101	Square Mouth	1	5	£85.00
OX-P283301	Cable Laying	1	5	£85.00



PRO MINI ROUND POINT SHOVEL

FEATURES

- Compact round point mini shovel, ideal for use in confined spaces
- Strong steel blade and lightweight fibreglass reinforced shaft
- Comfortable soft grip handle

Product Code	Size	Order Qty	Box Qty	List Price
OX-P283401	-	1	1	£15.00



PRO MINI SQUARE MOUTH SHOVEL

FEATURES

- Compact square mouth mini shovel, ideal for use in confined spaces
- Strong steel blade and lightweight fibreglass reinforced shaft
- Comfortable soft grip handle

Product Code	Size	Order Qty	Box Qty	List Price
OX-P283501	-	1	1	£15.00



10
BOX

PRO TOUGH BUCKET 15L

FEATURES

- Extremely durable design
- Manufactured with a high rubber content which allows the material to bend and flex rather than split and crack
- The toughest bucket you'll ever use
- Easy to clean, maintain and keep hygienic



CHECK OUT THE YOUTUBE TUTORIAL HERE

Product Code	Size	Order Qty	Box Qty	List Price
OX-P112315	15L	10	10	£8.15



10
BOX

PRO BUCKET 15L

FEATURES

- Extremely hardwearing
- 15L capacity
- Pouring spout for easy pour
- Easy to clean

Product Code	Size	Order Qty	Box Qty	List Price
OX-P110515	15L / 3 gal	10	10	£6.00



TRADE BLACK BUCKET 15L

FEATURES

- Black plastic bucket
- 15l capacity
- Pouring spout for easy pour
- Easy to clean

Product Code	Size	Order Qty	Box Qty	List Price
OX-T110715	15l	10	10	£3.50



PRO PLASTERERS BUCKET 25L

FEATURES

- Heavy duty bucket which can be used for mixing plaster
- Strong wire handle and plastic carry grip



CHECK OUT THE YOUTUBE TUTORIAL HERE

Product Code	Size	Order Qty	Box Qty	List Price
OX-P110825	25l	5	5	£17.50



PRO HEAVY DUTY FLEXI TUB 20L, 42L, 73L

FEATURES

- Polyethylene flex tub

Product Code	Size	Order Qty	Box Qty	List Price
OX-P110620	20l	1	10	£8.50
OX-P110642	42l	1	10	£11.50
OX-P110673	73l	1	5	£29.35



PRO VERY HEAVY DUTY WATER BOTTLE - 10L

FEATURES

- Very heavy duty water supply tank
- Heavy duty carry handle
- Robust polythene casing
- Protected hose connection, prevents damage or breakage during use
- 4M transparent hose for extra working length
- Strong and stable base protects the bottom of the bottle and gives extra stability in use
- Portable water tank for sawing and drilling equipment

Product Code	Size	Order Qty	Box Qty	List Price
OX-P10L	10l	1	1	£120.23



PRO HEAVY DUTY WATER BOTTLE 15L

FEATURES

- Very heavy duty water supply tank
- Portable water tank for sawing and drilling equipment
- Heavy duty carry handle
- 15 litre capacity

Product Code	Size	Order Qty	Box Qty	List Price
OX15L	15l	1	6	£57.50



TRADE PUMP ACTION PRESSURE SPRAYER 5L

FEATURES

- Easy to use pump handle for lifting and pressurisation
- Adjustable wand nozzle and adjustable trigger
- Adjustable shoulder strap
- Ideal for watering or using fertilizers, cleaning products such as detergents dissolved in water
- Wide screw thread opening for quick refilling

Product Code	Size	Order Qty	Box Qty	List Price
OX-T045105	5l	1	6	£12.41



TRADE SLATERS RIPPER

FEATURES

- Heavy duty construction
- Soft grip handle for comfort during use
- Forged steel construction
- Built for ultimate durability
- Suitable for shearing off fixing nails prior to the replacement of damaged slates

Product Code	Size	Order Qty	Box Qty	List Price
OX-T540301	750mm	1	8	£16.05



TRADE SLATERS AXE

FEATURES

- Soft grip handle for comfort during use
- Ground polished cutting edge for clean cutting of slates
- Hardened and tempered piercing spike for creating nail holes
- Heavy duty
- Forged steel construction
- Built for ultimate durability
- Available in both right and left hand versions

Product Code	Size	Order Qty	Box Qty	List Price
OX-T540401	Right Handed	1	6	£19.95
OX-T540501	Left Handed	1	6	£19.95

TRADE LEAD DRESSER

FEATURES

- Specialist tool designed for shaping, bending and dressing lead to fit specific applications
- Wooden face which is less likely to mark the surface
- Manufactured from Beech wood which is responsibly sourced from FSC certified forests
- Shape features rounded corners and an elevated handle grip, providing sufficient space for your knuckles while hammering
- Strap at the end to hang the product when not in use



Product Code	Size	Order Qty	Box Qty	List Price
OX-T540601	-	1	10	£16.95

PRO ONE SHOT OIL – 100ML

FEATURES

- Semi synthetic two-stroke oil one shot
- This will meet the lubrication requirements of all modern static two-stroke engines
- Attractive display box packaging to hold 25 pcs



Product Code	Size	Order Qty	Box Qty	List Price
OX-P189301	100ml	25	25	£2.50

TRADE PERMANENT LINE MARKER SPRAY

FEATURES

- Suitable for all road marking systems
- High colour pigment & fast drying



Product Code	Description	Order Qty	Box Qty	List Price
OX-T022601	Yellow	6	6	£6.50
OX-T022602	Blue	6	6	£6.50
OX-T022603	White	6	6	£6.50
OX-T022604	Red	6	6	£6.50
OX-T022605	Orange	6	6	£6.50
OX-T022606	Green	6	6	£6.50
OX-T022607	Black	6	6	£6.50

TRADE 3 PIECE PAINT BRUSH SET – 25/38/50MM

FEATURES

- High grade mixed synthetic fibres ideal for applying water and oil-based paints and varnishes ensures a superior finish
- Easily cleaned
- Stainless steel ferrules
- Fsc certified wooden handles which means raw materials are responsibly sourced and sensitively processed



Product Code	Size	Order Qty	Box Qty	List Price
OX-T046103	25/38/50mm	1	20	£8.00



PRO ECO TUFF WIPES - TUB/REFILL

FEATURES

- Tub contains 80 wipes
- 100% biodegradable wipe material containing natural eucalyptus fibres
- Super absorbent wipe with anti-bacterial degreasing cleaning solution
- Powerful degreaser makes light work of stains, silicone and tough oily spots
- FSC Accredited
- 3 year shelf life
- Top up pouches contain 80 large absorbent degreasing wipes
- Fully recyclable resealable pouch

Product Code	Size	Order Qty	Box Qty	List Price
OX-P351008	Tub	6	10	£9.95
OX-P351108	Refill	12	10	£7.95



SECTION 13

TOOLTREK



PRO TOOLTREK STORAGE SYSTEM - 3 PIECE



Product Code	Size	Order Qty	Box Qty	List Price
OX-P600703	-	1	1	£185.00





TOOLTREK TRADE TOOL STORAGE SYSTEM 3 PIECE

FEATURES

- Waterproof and dust proof design with IP54 rating
- Versatile modular storage system
- High-impact polycarbonate clear organiser lid for added protection
- Extendable handle
- 70kg load capacity

Product Code	Size	Order Qty	Box Qty	List Price
OX-T602703	-	1	1	£130.00



TOOLTREK CUSTOM M8 CONNECTOR KIT

FEATURES

- Includes 6 toolbox connectors, 6 universal connectors, 12 clips & 6 M8 Bolts
- High-impact see through polycarbonate lid for added protection
- Integrates seamlessly with other TOOLTREK products
- Up to 8 compartments with removable inserts to allow more internal space if required
- Built in handle for easy transportation

Product Code	Size	Order Qty	Box Qty	List Price
OX-P600801	-	1	1	£24.00



TOOLTREK MINI ORGANISER

FEATURES

- Up to 8 compartments with removable inserts to allow more internal space if required
- High-impact see through polycarbonate lid for added protection
- Integrates seamlessly with other TOOLTREK products
- Snap-lock latches
- Built in handle for easy transportation

Product Code	Size	Order Qty	Box Qty	List Price
OX-P602406	-	1	1	£7.95



TOOLTREK TRADE ORGANISER 100

FEATURES

- Includes 8 removable storage compartments ideal for storing small parts & accessories
- Connects seamlessly with other TOOLTREK products
- High-impact see through polycarbonate lid for added protection
- Built in handle for easy transportation

Product Code	Size	Order Qty	Box Qty	List Price
OX-T601610	-	1	1	£25.00



TRADE SAW HORSE SET OF 2 WITH TOOLTREK CONNECTORS

FEATURES

- Saw horses maximum load capacity 350kg
- Equipped with stabilising slots for secure material cutting
- TOOLTREK connectors for seamless integration with the TOOLTREK Pro storage system

Product Code	Size	Order Qty	Box Qty	List Price
OX-T336202	782 x 582 x 110mm	1	1	£56.00

SECTION 14

TOOL STORAGE





PRO ROUND TOP TOOL BAG

FEATURES

- Extremely tough construction for ultimate durability
- Injected polypropylene hard base
- Strong rubber grip handle and padded shoulder strap
- Waterproof base moulded to fabric

Product Code	Size	Order Qty	Box Qty	List Price
OX-P261747	470 x 280 x 350mm	1	2	£85.08



PRO SUPER OPEN MOUTH TOOL BAG

FEATURES

- Extremely tough construction for ultimate durability
- Injected polypropylene hard base
- Strong rubber grip handle and padded shoulder strap
- Waterproof base moulded to fabric

Product Code	Size	Order Qty	Box Qty	List Price
OX-P261645	450 x 310 x 260mm	1	2	£75.64



PRO OPEN TOOL TOTE BAG

FEATURES

- Extremely tough construction for ultimate durability
- Injected polypropylene hard base
- Heavy-duty steel handle with rubber grip
- Waterproof base moulded to fabric



CHECK OUT THE YOUTUBE TUTORIAL HERE

Product Code	Size	Order Qty	Box Qty	List Price
OX-P262618	470 x 250 x 360mm	1	4	£60.77



PRO TOOLBOX

FEATURES

- Strong lid made from grade one polypropylene
- 3 Translucent lid compartments
- Easy grip handle
- Ribbed areas for extra strength and durability
- Robust lid with 3 compartments and 2 removable dividers
- Water resistant
- Hinged lid
- Removable tote tool tray
- Lockable
- For professional and DIY users
- Tools not included

Product Code	Size	Order Qty	Box Qty	List Price
OX-P266019	490 x 250 x 250mm	1	2	£22.45



PRO INTERLOCKING DRAWER ORGANISER

FEATURES

- Made from grade one polypropylene plastic
- Secure plastic latches
- Patented interlocking system
- See through cover for easier usage
- 12 Removable dividers
- 20 Compartments
- Hinged lid
- Heavy duty bin organiser
- Water resistant
- For professional and DIY users

Product Code	Size	Order Qty	Box Qty	List Price
OX-P266114	370 x 280 x 60mm	1	6	£12.82



PRO DYNAMIC NYLON TOOL BELT WITH ATTACHMENTS

FEATURES

- Includes a fastener, framing pouch, padded back support and a hammer holder
- Drill holder fits most cordless drills and secures with Velcro strap for quick holstering and retrieval
- Two large pockets designed for nails and fasteners
- Large inner pouch holds tape measures chalk reels, speed squares, and other framing tools
- A smaller zipper pocket holds important items and keeps them safe from dust, debris, rain, or sun

Product Code	Size	Order Qty	Box Qty	List Price
OX-P267401	-	1	3	£74.37



PRO DYNAMIC NYLON TOOL BELT WITH BACK SUPPORT

FEATURES

- Padded support for the lower back relieving pressure from common stress areas
- Suitable for waist sizes 29"-46"
- Hardwearing and durable design
- Electrophoretic coated hook & rivets for corrosion and chemical resistance
- 1680D Ballistic Nylon with PVC Coating for strength and durability

Product Code	Size	Order Qty	Box Qty	List Price
OX-P266410	-	1	3	£24.08



PRO DYNAMIC NYLON DRYWALLERS POUCH

FEATURES

- 4 dedicated pockets, 3 tool holders for storing x1 hammer, x1 tape measure and pencils
- Specifically designed for plasterers/drywallers
- Electrophoretic coated hook & rivets for corrosion and chemical resistance
- 1680D Ballistic Nylon with PVC Coating for strength and durability

Product Code	Size	Order Qty	Box Qty	List Price
OX-P266201	-	1	3	£20.87



PRO DYNAMIC 7 POCKET POUCH WITH HAMMER HOLDER

FEATURES

- 7 dedicated pockets to store a wide variety of tools
- Includes a built-in hammer holder
- Electrophoretic coated hook & rivets for corrosion and chemical resistance
- 1680D Ballistic Nylon with PVC Coating for strength and durability

Product Code	Size	Order Qty	Box Qty	List Price
OX-P266202	-	1	3	£26.75



PRO DYNAMIC NYLON ELECTRICIANS POUCH

FEATURES

- 2 dedicated pockets for larger tools and 12 universal tool holders for items such as pliers and screwdrivers
- Includes built in tape measure holder
- Electrophoretic coated hook & rivets for corrosion and chemical resistance
- 1680D Ballistic Nylon with PVC Coating for strength and durability

Product Code	Size	Order Qty	Box Qty	List Price
OX-P266203	-	1	3	£18.19



PRO DYNAMIC NYLON FRAMERS NAIL POUCH

FEATURES

- Features five pockets for various hardware including a zipped pocket to keep content secure and a supporting a claw bar holster.
- Specifically designed for framers
- Electrophoretic coated hook & rivets for corrosion and chemical resistance
- 1680D Ballistic Nylon with PVC Coating for strength and durability

Product Code	Size	Order Qty	Box Qty	List Price
OX-P266206	-	1	3	£40.66



PRO DYNAMIC NYLON FASTENER MULTIPURPOSE POUCH

FEATURES

- Five Pockets, Pencil Holder, Claw Bar loop, & Tape Measure Clip.
- Electrophoretic coated hook & rivets for corrosion and chemical resistance
- 1680D Ballistic Nylon with PVC Coating for strength and durability
- Water and UV resistant.

Product Code	Size	Order Qty	Box Qty	List Price
OX-P266207	-	1	3	£38.52



PRO DYNAMIC NYLON CORDLESS DRILL POUCH

FEATURES

- Designed to safely secure most cordless drills with securing Velcro strap for safe holstering and easy retrieval
- Compatible with 2-inch or 3-inch belts
- Electrophoretic coated hook & rivets for corrosion and chemical resistance
- 1680D Ballistic Nylon with PVC Coating for strength and durability

Product Code	Size	Order Qty	Box Qty	List Price
OX-P266505	-	1	3	£13.38



PRO DYNAMIC NYLON FIXED HAMMER HOLDER

FEATURES

- Designed to safely store a hammers while remaining easily accessible
- Compatible with 2-inch or 3-inch belts
- Electrophoretic coated hook & rivets for corrosion and chemical resistance
- 1680D Ballistic Nylon with PVC Coating for strength and durability

Product Code	Size	Order Qty	Box Qty	List Price
OX-P266507	-	1	3	£10.17

PRO OIL TANNED TOP GRAIN LEATHER FRAMER'S TOOL RIG

FEATURES

- Perimeter stitched and heavy duty rivet reinforcement to increase tear resistance
- Belt tunnel reinforced for ultimate strength
- Suitable for waist sizes 29" - 46"
- Comprehensive layout of 22 storage pockets
- Built in steel tape measure clip
- High quality top grain oil-tanned saddle leather
- x2 steel hammer loops
- Antique, bronze finish to steel loops, hooks and clasps
- 3" wide leather tool belt with easily adjustable strong double notch steel clasp



Product Code	Size	Order Qty	Box Qty	List Price
OX-P263605	-	1	3	£149.75

PRO OIL TANNED LEATHER 4 PIECE CONSTRUCTION RIG

FEATURES

- Perimeter stitched reinforcement to increase tear resistance and withstand vigorous conditions on site
- Comprehensive layout of 22 storage pockets
- Belt tunnel reinforced for ultimate strength
- Built in tape measure clip
- Heavy duty rivet reinforcement
- Made from high quality top grain oil-tanned saddle leather
- Antique bronze finish to steel loops, hooks and clasps



Product Code	Size	Order Qty	Box Qty	List Price
OX-P263604	29" - 46" Waist	1	3	£139.05

PRO OIL TANNED LEATHER 3" BELT

FEATURES

- High quality top grain oil tanned saddle leather
- Perimeter stitching reinforcement to increase tear resistance and withstand tough conditions on site
- Strong durable double notch steel clasp
- Antique, bronze finish hardware
- For use in conjunction with the OX Pro leather tool pouches



Product Code	Size	Order Qty	Box Qty	List Price
OX-P263301	SMALL/MEDIUM 26-34" Waist	1	3	£20.28
OX-P263303	LARGE 29-46" Waist	1	3	£21.35
OX-P263305	XXLARGE 46-54" Waist	1	3	£25.63



PRO OIL TANNED LEATHER BRACES

FEATURES

- The padded support is made from heavy-duty nylon with foam support for added comfort while on the job
- The ultimate leather padded suspender is made with supple & durable oil tanned leather creating a solid premium appeal
- Fully adjustable chest strap
- Leather loops help to secure attachment to your tool belt
- It makes carrying tools pouches and tools effortless

Product Code	Size	Order Qty	Box Qty	List Price
OX-P263501	-	1	3	£47.62



PRO OIL TANNED LEATHER 14 POCKET TOP GRAIN POUCH WITH AIR GUN HOLDER

FEATURES

- Top grain oil tanned leather
- Heavy duty rivet reinforcement
- Belt tunnel reinforcement

Product Code	Size	Order Qty	Box Qty	List Price
OX-P263514	-	1	3	£94.16



PRO OIL TANNED LEATHER 10 POCKET TOOL POUCH

FEATURES

- 10 Tool holders and pouches
- Belt tunnel double layer reinforcement for tear resistance
- Top grain, oil tanned saddle leather
- Steel hammer loop
- Heavy duty rivet reinforcement

Product Code	Size	Order Qty	Box Qty	List Price
OX-P263701	-	1	3	£51.31



PRO 4 POCKET POUCH WITH DUAL HAMMER HOLDERS

FEATURES

- 10 Tool holders and pouches
- Belt tunnel double layer reinforcement for tear resistance
- Top grain, oil tanned saddle leather
- x2 steel hammer loop
- Heavy duty rivet reinforcement

Product Code	Size	Order Qty	Box Qty	List Price
OX-P263701DUS	-	1	3	£56.71



PRO OIL TANNED LEATHER DRYWALLERS TOOL POUCH

FEATURES

- 12 Tool holders and pockets
- Top grain oil tanned saddle leather
- Multi function leather loop for hammer, hatchet, or rasp
- Built in tape measure clip
- Heavy duty rivet reinforcement
- Please note toolbelt OX-P263303 not included

Product Code	Size	Order Qty	Box Qty	List Price
OX-P263801	-	1	3	£41.68



PRO FRAMER'S TOOL BAG, OIL-TANNED LEATHER, 3 POUCH

FEATURES

- 10 tool holders and pouches
- Heavy-duty rivet reinforcement
- Double layer reinforcement for tear resistance
- X2 pencil/marker holders
- Top-grain, oil-tanned 'saddle' leather
- Built in tape measure clip

Product Code	Size	Order Qty	Box Qty	List Price
OX-P263203	-	1	3	£64.15



PRO FASTENER BAG, OIL-TANNED LEATHER, 3 POUCH

FEATURES

- Includes 3 large pouches for hardware and 6 accessory pouches
- Heavy-duty rivet reinforcement
- Double layer reinforcement for tear resistance
- Top-grain, oil-tanned 'saddle' leather

Product Code	Size	Order Qty	Box Qty	List Price
OX-P263503	-	1	3	£62.60



PRO HAMMER HOLDER, OIL-TANNED LEATHER

FEATURES

- Hammer loop for securely holding hammers
- Perimeter stitched to increase tear resistance and withstand vigorous conditions on site
- For use in conjunction with the OX Pro 3" Tool Belt
- Top-grain, oil-tanned 'saddle' leather
- Antique, bronze finish to steel loop

Product Code	Size	Order Qty	Box Qty	List Price
OX-P263401	-	1	3	£10.17



SECTION 15

TCT BLADES



WORLD LEADING TECHNOLOGY...



OX has redefined excellence in the world of circular saw blades with the introduction of its superfast range.

These revolutionary saw blades have a stronger tooth bond that provides up to 50% longer life. The carbide teeth are made from a tougher than standard carbide that stays sharp longer and are sharpened to finer more durable cutting edges that produce a faster and straighter cut.

Blade cores are made from the highest quality steel, precision engineered, ground and hardened.

BLADE SELECTION & PRESENTATION



WOOD - SPEED CUT/COARSE FINISH

For ripping through softwood, hardwood & plywood.



WOOD - CROSS CUT/MEDIUM FINISH

For cutting through softwood, hardwood & plywood.



WOOD - FINE FINISH

For cutting through softwood, hardwood, plywood, MDF, hardboard and wood laminates.



WOOD - EXTRA FINE FINISH

For very fine finish when cutting through softwood, hardwood, plywood, MDF, hardboard and wood laminates.



ALUMINIUM/PLASTIC/LAMINATE - EXTRA FINE FINISH

For cutting non-ferrous metals including aluminium, plastic and wood laminates.



PCD FIBRE CEMENT CUTTING BLADE

With polycrystalline diamond tipped teeth this blade produces faster cutting ability and far longer life when cutting fibre cement board.

WOOD CUTTING BLADE

A range of high quality circular saw blades designed for a professional finish and long cutting life.



Brazed tungsten tip



Supplied with reducing rings

(extra care must be taken when mounting blade to machine when using these)

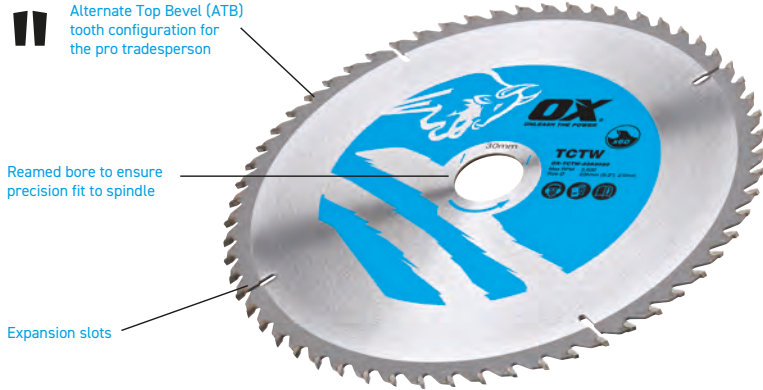

|| Alternate Top Bevel (ATB) tooth configuration for the pro tradesperson

Reamed bore to ensure precision fit to spindle

Expansion slots

Safe and secure blister pack

Supplied with reducing rings

Reference chart to show alternative blades available in the same size

Diameter and bore size

Number of teeth

Clear graphics showing blade type and application

Tooth type

Angle of tooth



TCTW WOOD CUTTING BLADE

Product Code	Dia (mm)	Bore (mm)	Teeth	Kerf/Plate	Type	List Price
OX-TCTW-1602020	160	20	20	2.6/1.8	ATB	£7.92
OX-TCTW-1602040	160	20	40	2.6/1.8	ATB	£12.26
OX-TCTW-1602060	160	20	60	2.6/1.8	ATB	£14.52
OX-TCTW-1841620	184	16	20	2.8/2.0	ATB	£15.25
OX-TCTW-1843028	184	30	28	2.8/2.0	ATB	£17.13
OX-TCTW-1843040	184	30	40	2.8/2.0	ATB	£18.68
OX-TCTW-1843060	184	30	60	2.8/2.0	ATB	£21.05
OX-TCTW-1902028	190	20	28	2.8/2.0	ATB	£18.05
OX-TCTW-1903020	190	30	20	2.8/2.0	ATB	£16.46
OX-TCTW-1903040	190	30	40	2.8/2.0	ATB	£19.59
OX-TCTW-1903060	190	30	60	2.8/2.0	ATB	£21.91
OX-TCTW-2103028	210	30	28	2.8/2.0	ATB	£19.92
OX-TCTW-2103040	210	30	40	2.8/2.0	ATB	£21.51
OX-TCTW-2103060	210	30	60	2.8/2.0	ATB	£23.85
OX-TCTW-2163028	216	30	28	2.8/2.0	ATB	£20.70
OX-TCTW-2163040	216	30	40	2.8/2.0	ATB	£22.25
OX-TCTW-2163060	216	30	60	2.8/2.0	ATB	£24.62
OX-TCTW-2163080	216	30	80	2.8/2.0	ATB	£28.52
OX-TCTW-2303024	230	30	24	2.8/2.0	ATB	£21.35
OX-TCTW-2353028	235	30	28	2.8/2.0	ATB	£25.24
OX-TCTW-2353040	235	30	40	2.8/2.0	ATB	£26.74
OX-TCTW-2353060	235	30	60	2.8/2.0	ATB	£29.15
OX-TCTW-2353080	235	30	80	3.0/2.2	ATB	£35.67
OX-TCTW-2503028	250	30	28	2.8/2.0	ATB	£29.10
OX-TCTW-2503040	250	30	40	2.8/2.0	ATB	£30.64
OX-TCTW-2503060	250	30	60	2.8/2.0	ATB	£33.02
OX-TCTW-2503080	250	30	80	2.8/2.0	ATB	£38.40
OX-TCTW-2603048	260	30	48	2.8/2.0	ATB	£33.30
OX-TCTW-2603060	260	30	60	2.8/2.0	ATB	£35.62
OX-TCTW-3003048	300	30	48	3.0/2.0	ATB	£43.29
OX-TCTW-3003060	300	30	60	3.0/2.0	ATB	£45.13
OX-TCTW-3003080	300	30	80	3.0/2.0	ATB	£55.27
OX-TCTW-3053032	305	30	32	3.0/2.0	ATB	£42.04
OX-TCTW-3053060	305	30	60	3.0/2.0	ATB	£46.72
OX-TCTW-3053096	305	30	96	3.0/2.0	ATB	£59.16



Cut Type
Speed Cut/Coarse Finish
Cross Cut/Medium Finish
Fine Finish
Extra Fine Finish

TCTW-NG WOOD CUTTING BLADE (NEGATIVE RAKE)

Product Code	Dia (mm)	Bore (mm)	Teeth	Kerf/Plate	Type	List Price
OX-TCTW-NG-2163028	216	30	28	2.8/2.0	ATB	£26.88
OX-TCTW-NG-2163040	216	30	40	2.8/2.0	ATB	£28.30
OX-TCTW-NG-2163060	216	30	60	2.8/2.0	ATB	£31.09
OX-TCTW-NG-2603060	260	30	60	2.8/2.0	ATB	£43.11
OX-TCTW-NG-3053040	305	30	40	2.8/2.0	ATB	£56.38
OX-TCTW-NG-3053060	305	30	60	2.8/2.0	ATB	£59.81
OX-TCTW-NG-30530100	305	30	100	3.0/2.0	TCG	£77.74

THIN KERF WOOD CUTTING BLADE

Thin kerf blades designed for cordless machines, with anti-kickback for smooth cutting action and safety during use. Also for use on rip saws.

Alternate Top Bevel (ATB) tooth configuration for the pro tradesperson

Reamed bore to ensure precision fit to spindle

Expansion slots



Brazed tungsten tip



Supplied with reducing rings (extra care must be taken when mounting blade to machine when using these)

TCTW-TF THIN KERF WOOD CUTTING BLADE



Product Code	Dia (mm)	Bore (mm)	Teeth	Kerf/Plate	Type	List Price
OX-TCTW-TF-1361020	136	10	20	1.5/1.0	ATB	£6.86
OX-TCTW-TF-1362020	136	20	20	1.5/1.0	ATB	£6.86
OX-TCTW-TF-1502020	150	20	20	1.5/1.0	ATB	£7.77
OX-TCTW-TF-1602024	160	20	24	1.6/1.0	ATB	£8.21
OX-TCTW-TF-1602040	160	20	40	1.6/1.0	ATB	£10.63
OX-TCTW-TF-1602060	160	20	60	1.6/1.0	ATB	£13.66
OX-TCTW-TF-1651624	165	16	24	1.6/1.0	ATB	£9.85
OX-TCTW-TF-1652024	165	20	24	1.6/1.0	ATB	£9.85
OX-TCTW-TF-1652040	165	20	40	1.6/1.0	ATB	£13.03
OX-TCTW-TF-1841628	184	16	28	1.6/1.0	ATB	£11.62
OX-TCTW-TF-1841640	184	16	40	1.6/1.0	ATB	£14.77
OX-TCTW-TF-1901628	190	16	28	1.6/1.0	ATB	£12.77
OX-TCTW-TF-1901640	190	16	40	1.6/1.0	ATB	£15.56

Cut Type
Speed Cut/Coarse Finish
Cross Cut/Medium Finish
Fine Finish
Extra Fine Finish

ALU/PLASTIC/LAMINATE CUTTING BLADE

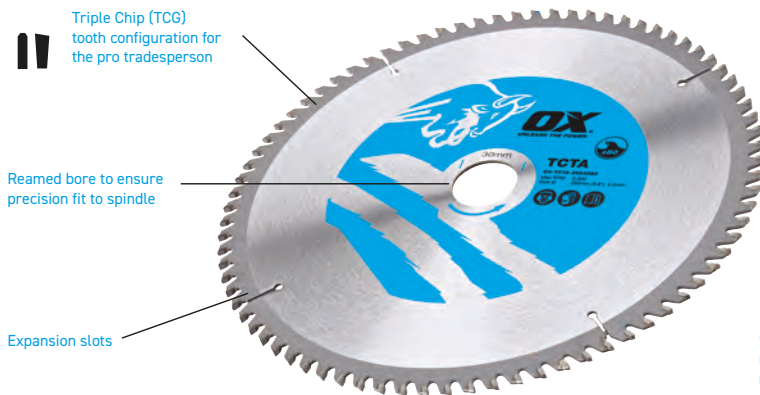

Brazed tungsten tip

Negative tooth angle for ultimate quality of cut



Supplied with reducing rings (extra care must be taken when mounting blade to machine when using these)

TCTA THIN KERF ALU/PLASTIC/LAMINATE CUTTING BLADE

Product Code	Dia (mm)	Bore (mm)	Teeth	Kerf/Plate	Type	List Price
OX-TCTA-1842048	184	20	48	2.4/1.8	TCG	£15.16
OX-TCTA-1903048	190	30	48	2.6/2.0	TCG	£19.59
OX-TCTA-2103060	210	30	60	2.8/2.2	TCG	£22.00
OX-TCTA-2163060	216	30	60	2.8/2.2	TCG	£22.25
OX-TCTA-2163080	216	30	80	2.8/2.2	TCG	£26.92
OX-TCTA-2503080	250	30	80	2.8/2.2	TCG	£40.78
OX-TCTA-25030100	250	30	100	2.8/2.2	TCG	£46.23
OX-TCTA-30030100	300	30	100	3.0/2.4	TCG	£65.39

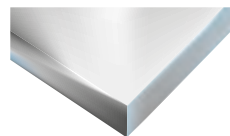

Cut Type
Speed Cut/Coarse Finish
Cross Cut/Medium Finish
Fine Finish
Extra Fine Finish

METAL CUTTING BLADE

Professional blade for clean, fast cutting of various metals including steel and stainless steel.

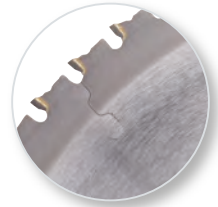

Brazed tungsten tip



Triple Chip (TCG) tooth configuration for the pro tradesperson



Reamed bore to ensure precision fit to the spindle

Anti kick back teeth for greater safety during use

TCTM

METAL BLADE

Product Code	Barcode	Dia (mm)	Bore (mm)	Teeth	Kerf/Plate	Type	List Price
OX-TCTM-3052560	5060359915672	305	25.4	60	2.6/2.0	TCG	£100.92
OX-TCTM-3552580	5060359915665	355	25.4	80	2.6/2.0	TCG	£125.15

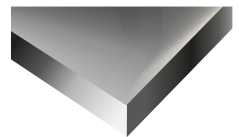

PCD FIBRE CEMENT CUTTING BLADE

With polycrystalline diamond tipped teeth this blade produces faster cutting ability and far longer life when cutting fibre cement board.

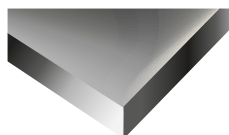
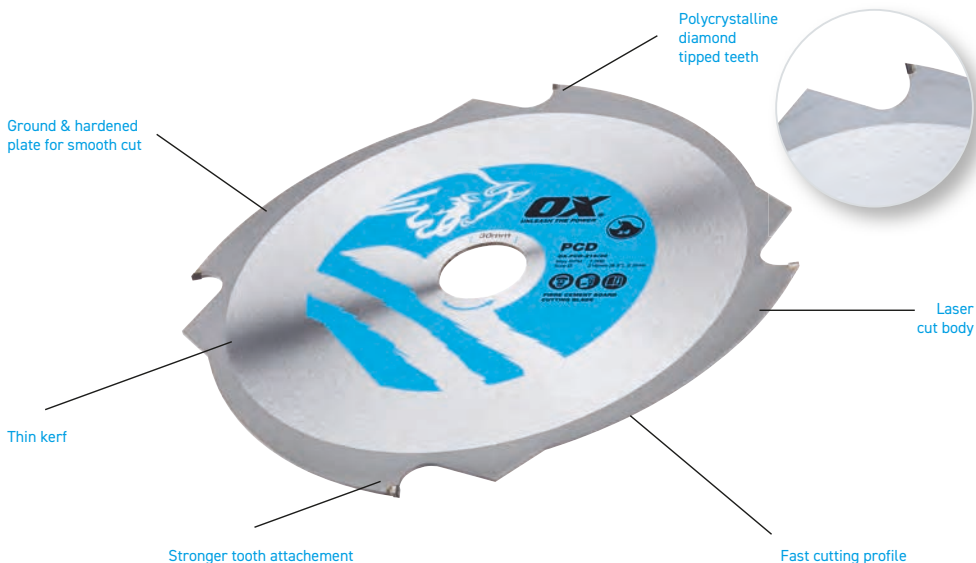

PCD ULTIMATE FIBRE CEMENT BLADE

Product Code	Diameter (mm)	Bore (mm)	List Price
OX-PCD-160/20	160	20	£63.76
OX-PCD-165/20	165	20	£64.34
OX-PCD-190/30	190	30	£65.71
OX-PCD-216/30	216	30	£83.30
OX-PCD-235/30	235	30	£108.85
OX-PCD-250/30	250	30	£111.23
OX-PCD-260/30	260	30	£112.26
OX-PCD-305/30	305	30	£173.18

SECTION 16

DIAMOND BLADES





**WORLD LEADING
DIAMOND
TECHNOLOGY...**

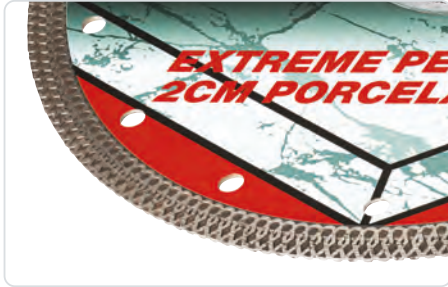

Only the finest quality of diamond is used in the production of Spectrum products



Blade cores are made of the highest quality steel, precision engineered, ground and hardened



State of the art laser technology for ultimate performance and safety

MATERIAL CLASSES

UNIVERSAL HARD

Hard materials & metal
Fast cutting universal
Hard natural stone
Clay products
Engineering bricks

CONCRETE

Concrete & concrete products
General purpose
Unabrasive products
Building products

ABRASIVE

Abrasive materials
Concrete & asphalt
Dual purpose
Concrete products
Concrete roof tiles

ASPHALT

Asphalt & extremely
abrasive products
Cement screed
Lignacite blocks

SPECTRUM MAESTRO - 10MM GENERAL PURPOSE

xxxxxxx

APPLICATIONS

■ xxxxxx

TRADE XL SERIES



TXL TURBO | XLT



XL SUPER | XLS



XL ABRASIVE | XLA

PREMIUM SERIES



PREMIUM TURBO | DX10



DOUBLE SIX | DCX



PREMIUM ABRASIVE | DCA



PREMIUM ASPHALT | DA

PRO SERIES



PRO TURBO | TX10R



PRO CONCRETE | MCX



PRO ABRASIVE | MCA



PRO ASPHALT | MA

The OX Maestro Series diamond blade is suitable for general purpose use for builder and tradesman alike. The blade is versatile and durable for cutting concrete product such as pavements, slabs, kerbs and hard reinforced materials.



SPECTRUM MAESTRO – 10MM GENERAL PURPOSE

The TC10 Spectrum Maestro blade is an excellent value long life general purpose blade with a 10mm segment height.

APPLICATIONS

- Suitable for concrete products such as pavements, slabs, kerbs and general building materials.

Product Code	Diameter (mm)	Bore (mm)	List Price
TC10-115/22	115	22.2	£6.60
TC10-125/22	125	22.2	£8.47
TC10-230/22	230	22.2	£17.89
TC10-300/20	300	20	£36.79
TC10-350/20	350	20	£59.00
TC10-350/25	350	25.4	£59.00

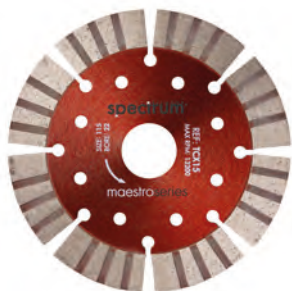

SPECTRUM MAESTRO – 15MM UNIVERSAL TURBO-SEG

The TCX15 Spectrum Maestro blade is an excellent value long life general purpose blade with a 15mm segment height.

APPLICATIONS

- Suitable for concrete products such as pavements, slabs, kerbs and general building materials

Product Code	Diameter (mm)	Bore (mm)	List Price
TCX15-115/22	115	22.2	£19.79
TCX15-125/22	125	22.2	£23.79
TCX15-230/22	230	22.2	£52.79
TCX15-300/20	300	20	£89.79



The Contractor Series gives the benefit of a safe performing product for the cost conscious user.



CONTRACTOR GTT – G P, TURBO & CERAMIC TRIPLE PACK

3 Pack includes General Purpose, Turbo & Ceramic Blades.

APPLICATIONS

- G.P. Blade – bricks and slabs, concrete paviors, roof tiles, concrete products.
- Turbo Blade - bricks and slabs, concrete paviors, roof tiles, concrete products.
- Ceramic Blade - ceramic tiles.

Product Code	Diameter (mm)	Bore (mm)	List Price
X3-GTT-115/22	115	22.2	£11.88



CONTRACTOR CGS – GENERAL PURPOSE TRIPLE PACK

Contractor CGS Diamond Blade Triple Pack 115/22.23mm.

APPLICATIONS

- Bricks and slabs, concrete paviors, roof tiles, concrete products.

Product Code	Diameter (mm)	Bore (mm)	List Price
X3-CGS-115/22	115	22.2	£11.64



CONTRACTOR CGS – GENERAL PURPOSE

Entry level diamond blade for the cost conscious user.
General purpose use.

APPLICATIONS

- Bricks and slabs, concrete paviors, roof tiles, concrete products.

Product Code	Diameter (mm)	Bore (mm)	List Price
CGS-115/22	115	22.2	£3.90
CGS-230/22	230	22.2	£12.90
CGS-300/20	300	20	£19.90



CONTRACTOR CG10 – GENERAL PURPOSE

General purpose blade with a 10mm segment height for longer life.

APPLICATIONS

- Bricks and slabs, concrete paviors, roof tiles, concrete products.

Product Code	Diameter (mm)	Bore (mm)	List Price
CG10-115/22	115	22.2	£4.90
CG10-230/22	230	22.2	£14.90
CG10-300/20	300	20	£25.90

TRADE XL SERIES DIAMOND BLADES

The OX Spectrum Trade XL Series offers the perfect balance between quality and value for money. This comprehensive range of fantastic looking diamond blades covers speed, long life and ultimate value offering the trades person a blade for every application.



TRADE XL XL10 – GENERAL PURPOSE

10mm Segmented General purpose building materials cutting blade.

APPLICATIONS

- Standard facing bricks, precast concrete products, concrete paviors, concrete kerbs & slabs and general purpose building products.

Product Code	Diameter (mm)	Bore (mm)	List Price
XL10-105/16	105	16	£5.63
XL10-115/22	115	22.2	£6.28
XL10-125/22	125	22.2	£7.24
XL10-230/22	230	22.2	£18.19
XL10-300/20	300	20	£33.03
XL10-350/20	350	20	£46.00



TRADE XL XLT TURBO – UNIVERSAL/HARD

Semi continuous rim turbo blade for fast cutting of universal and general building products, 10mm segment height.

APPLICATIONS

- Precast concrete products, clay products, indian sandstone, engineering bricks, limestone and slate.

Product Code	Diameter (mm)	Bore (mm)	List Price
XLT-115/22	115	22.2	£6.94
XLT-230/22	230	22.2	£19.67
XLT-300/20	300	20	£35.18



TRADE XL XLS SUPER – CONCRETE

10mm Turbo Segment blade for fast cutting of concrete products and general building materials.

APPLICATIONS

- Medium to hard building products, kerbs & slabs, concrete paviors, light reinforced concrete, granite kerbs and general purpose building products.

Product Code	Diameter (mm)	Bore (mm)	List Price
XLS-115/22	115	22.2	£6.94
XLS-230/22	230	22.2	£19.67
XLS-300/20	300	20	£35.18



TRADE XL XLA – ABRASIVE

For cutting more abrasive and general purpose building materials and concrete products, 10mm segment height.

APPLICATIONS

- Yorkstone, lightweight concrete blocks, concrete kerbs & slabs, concrete roof tiles and general purpose building products.

Product Code	Diameter (mm)	Bore (mm)	List Price
XLA-115/22	115	22.2	£6.94
XLA-125/22	125	22.2	£7.94
XLA-230/22	230	22.2	£19.67
XLA-300/20	300	20	£35.18
XLA-350/20	350	20	£49.59

The Premium Series allows blade users to get value for money without compromising on performance or safety. Not only are these the best blades available at this price level, they also offer the most comprehensive and clear choice. The exceptionally keen pricing of the DCX DOUBLE SIX (with the maxim 'don't chance it - get a double six everytime') has won over many users who previously bought only the least expensive discs.



PREMIUM DX10 TURBO - UNIVERSAL/HARD

Fast cutting universal blade, with 10mm segment. Features super fast turbo segment and cooling holes.

APPLICATIONS

- Concrete products, clay products, granite, engineering bricks, building products.

Product Code	Diameter (mm)	Bore (mm)	List Price
DX10-105/16	105	16	£11.10
DX10-115/22	115	22.2	£13.20
DX10-125/22	125	22.2	£15.90
DX10-150/22	150	22.2	£25.90
DX10-180/22	180	22.2	£29.90
DX10-230/22	230	22.2	£31.10
DX10-300/20	300	20	£52.80
DX10-350/20	350	20	£88.80
DX10-350/25	350	25.4	£88.80



PREMIUM DCX DOUBLE SIX - G. P.

The general purpose blade with a 12mm segment. All round performance.

APPLICATIONS

- building products, general purpose, kerbs and slabs, concrete paviers and blocks, roof tiles.

Product Code	Diameter (mm)	Bore (mm)	List Price
DCX-115/22	115	22.2	£13.20
DCX-125/22	125	22.2	£15.90
DCX-230/22	230	22.2	£31.10
DCX-300/20	300	20	£52.80
DCX-350/20	350	20	£68.80
DCX-350/25	350	25.4	£68.80



PREMIUM DCA- - ABRASIVE/GENERAL PURPOSE

Abrasive and general purpose blade with 10mm segment. Larger sizes suitable for cutting concrete on floorsaw.

APPLICATIONS

- General and abrasive building products, concrete paviors, concrete roof tiles, hard asphalt, breeze blocks.

Product Code	Diameter (mm)	Bore (mm)	List Price
DCA-105/16	105	16	£11.10
DCA-115/22	115	22.2	£13.20
DCA-125/22	125	22.2	£15.90
DCA-150/22	150	22.2	£25.90
DCA-180/22	180	22.2	£29.90
DCA-230/22	230	22.2	£31.10
DCA-300/20	300	20	£52.80
DCA-350/20	350	20	£88.80
DCA-350/25	350	25.4	£88.80
DCA-450/25	450	25.4	£158.00



PREMIUM DA - ASPHALT

Asphalt blade with 10mm drop segment undercut protection. Larger sizes suitable for cutting asphalt on floorsaw

APPLICATIONS

- Asphalt and extremely abrasive materials, render. Larger sizes suitable for cutting concrete on floorsaw.

Product Code	Diameter (mm)	Bore (mm)	List Price
DA-300/20	300	20	£52.80
DA-350/25	350	25.4	£88.80
DA-450/25	450	25.4	£158.00

The award winning, best selling PRO Series blades – including the TX10R – the best all round builders blade on the market. These are simply the best value for money blades available in this sector, giving performance you would associate with a professional product at a price that has revolutionised the market.



PRO TX10R SUPERFAST – MULTI-STEEL

Guaranteed to cut all construction products including metal. Excellent fast cut universal & hard materials. Reinforced flange. Cooling holes. Semi-transparent.

APPLICATIONS

- Granite, natural stone, clay products, engineering bricks, metal, concrete products, all building materials. Wear will increase on abrasive materials.

Product Code	Diameter (mm)	Bore (mm)	List Price
TX10R-105/16	105	16	£23.90
TX10R-115/22	115	22.2	£24.90
TX10R-125/22	125	22.2	£28.90
TX10R-150/22	150	22.2	£37.90
TX10R-180/22	180	22.2	£43.90
TX10R-230/22	230	22.2	£58.90
TX10R-300/20	300	20	£99.90
TX10R-350/20	350	20	£134.80
TX10R-350/25	350	25.4	£134.80

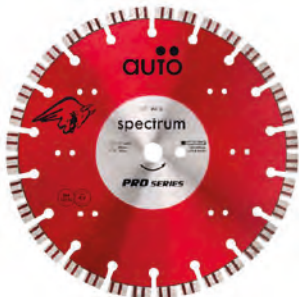

SPECTRUM PRO LASER TURBO UNIVERSAL DIAMOND BLADE

The fastest cutting universal blade ever, superfast turbo segments, Cooling holes.

APPLICATIONS

- Guaranteed to cut all general building products including hard natural stone, hard concrete, clay products, Indian sandstone, engineering bricks and granite.

Product Code	Diameter (mm)	Bore (mm)	List Price
MX10-115/22	115	22.2	£24.90
MX10-125/22	125	22.2	£28.90
MX10-230/22	230	22.2	£58.91
MX10-300/20	300	20	£94.43



PRO MCX SUPERCUT – CONCRETE

Durable 'Cuts it all' general purpose and concrete products blade with 15mm segment and cooling holes.

APPLICATIONS

- Concrete kerbs and slabs, concrete paviors, roof tiles, bricks, general building materials.

Product Code	Diameter (mm)	Bore (mm)	List Price
MCX115/22	115	22.2	£24.90
MCX230/22	230	22.2	£58.90
MCX300/20	300	20	£99.90
MCX350/20	350	20	£128.80
MCX350/25	350	25.4	£128.80



PRO MC – CONCRETE

High quality blade with 10mm segment. Used by professionals.

APPLICATIONS

- In-situ concrete - flint and limestone aggregate, reinforced concrete. Ideal for floorsaw cutting of concrete.

Product Code	Diameter (mm)	Bore (mm)	List Price
MC350/25	350	25.4	£138.80
MC450/25	450	25.4	£218.00



PRO MCA ZEBRA – ABRASIVE

High performance dual purpose blade with 10mm segment and wedge undercut protection.

APPLICATIONS

- Abrasive building materials, concrete products, roof tiles, blocks, floorsaw concrete & dual concrete/asphalt. Larger sizes suitable for floorsaw use.

Product Code	Diameter (mm)	Bore (mm)	List Price
MCA105/16	105	16	£23.90
MCA115/22	115	22.2	£24.90
MCA125/22	125	22.2	£28.90
MCA150/22	150	22.2	£37.90
MCA180/22	180	22.2	£43.90
MCA230/22	230	22.2	£58.90
MCA300/20	300	20	£99.90
MCA350/20	350	20	£128.80
MCA350/25	350	25.4	£128.80
MCA400/20	400	20	£178.80
MCA400/25	400	25.4	£178.80
MCA450/25	450	25.4	£198.00



PRO MA SHARK – ASPHALT

Undercut protected blade with 10mm segment and wedge undercut protection.

APPLICATIONS

- Asphalt and extremely abrasive products. Larger sizes suitable for floorsaw use.

Product Code	Diameter (mm)	Bore (mm)	List Price
MA300/20	300	20	£99.90
MA350/20	350	20	£128.80
MA350/25	350	25.4	£128.80
MA450/25	450	25.4	£198.00

The Ultimate range. Sophisticated, yet concise. Comprehensive, without compromising clarity. We've put together this range with careful consideration to everything you would expect from the highest quality blades on the market – and a lot you may never have thought of. With the range consisting of four main blades to cover every situation, your discerning customer need look no further. Impressive presentation backed up by excellent merchandising creates blades that are desirable.



ULTIMATE ZX10 AUTO – UNIVERSAL/HARD

Auto-Array technology allows the diamonds to be placed evenly to an exact specification. This produces exceptionally fast cutting speed and the ability to cut the hardest concrete and natural stone.

APPLICATIONS

- Hard natural stone, hard concrete, clay products & general building materials.

Product Code	Diameter (mm)	Bore (mm)	List Price
ZX10-350/25/20	350	20/25.4	£198.80
ZX10-450/25	450	25.4	£318.00
ZX10-500/25	500	25.4	£398.00



ULTIMATE ZCX CYCLONE – CONCRETE

Blade with 10mm segment height. Featuring tear drop gullet design, cooling holes, reinforced centre flange.

APPLICATIONS

- In-situ concrete (including reinforced), concrete products, natural stone, building materials, steel. Ideal 'civils' blade.

Product Code	Diameter (mm)	Bore (mm)	List Price
ZCX115/22	115	22.2	£35.40
ZCX125/22	125	22.2	£39.40
ZCX230/22	230	22.2	£78.90
ZCX300/20	300	20	£119.90



ULTIMATE ZCA ZEBRA – ABRASIVE

Dual purpose blade with 10mm segment height. Featuring 'wedge segment' undercut protection, narrow gullet.

APPLICATIONS

- Asphalt & extremely abrasive products, cement screed, lignacite blocks.

Product Code	Diameter (mm)	Bore (mm)	List Price
ZCA115/22	115	22.2	£35.40
ZCA125/22	125	22.2	£39.40
ZCA230/22	230	22.2	£78.90
ZCA300/20	300	20	£119.90
ZCA350/20	350	20	£158.80
ZCA350/25	350	25.4	£158.80
ZCA400/20	400	20	£218.00
ZCA400/25	400	25.4	£218.00
ZCA450/25	450	25.4	£258.00



ULTIMATE ZA BLACK SHARK – ASPHALT

Asphalt blade with 10mm segment height. Featuring 'wedge segment' undercut protection, 'U' clearance gullet.

APPLICATIONS

- Asphalt & extremely abrasive products, cement screed, lignacite blocks. Larger sizes suitable for cutting asphalt on floorsaw.

Product Code	Diameter (mm)	Bore (mm)	List Price
ZA230/20	230	20	£78.90
ZA300/20	300	20	£119.90
ZA350/20	350	20	£158.80
ZA350/25	350	25.4	£158.80
ZA450/25	450	25.4	£258.00



ULTIMATE ZCF CYCLONE - CONCRETE

Extremely high quality blade with 10mm segment. Used by professionals.

APPLICATIONS

- In-situ concrete - flint and limestone aggregate, reinforced concrete.

Product Code	Diameter (mm)	Bore (mm)	List Price
ZCF450/25	450	25.4	£298.00



ULTIMATE ZCA ZEBRA - DUAL PURPOSE

High performance dual purpose blade with 10mm segment and wedge undercut protection. Also Add larger sizes suitable for cutting concrete on floorsaw.

APPLICATIONS

- Concrete and asphalt, abrasive concrete, asphalt over concrete, concrete paviers.

Product Code	Diameter (mm)	Bore (mm)	List Price
ZCA500/25	500	25.4	£378.00
ZCA600/25	600	25.4	£448.00

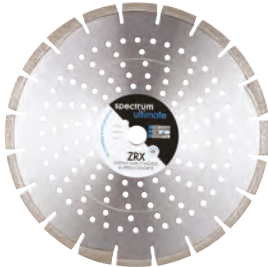

ULTIMATE ZRX - ASPHALT OVER CONCRETE

Specialist blade with 10mm segment height. Featuring 'wedge segment' undercut protection and narrow slot.

APPLICATIONS

- reen concrete, asphalt over concrete, dual concrete and asphalt, abrasive materials.

Product Code	Diameter (mm)	Bore (mm)	List Price
ZRX350/25	350	25.4	£119.90
ZRX450/25	450	25.4	£258.00



ULTIMATE KRB - KARBITE MULTI-PURPOSE

EA saw blade made up of carbide clusters to cut many products from timber to plastic, tree roots to rubber and is not put off by nails or screws. Available in 300 & 350mm for use on hand held disc cutters and 115 & 230mm for angle grinders.

APPLICATIONS

- Tree roots & soil, wooden boards & planks, fence panels, railway sleepers, small trees & branches, thin sheet metal, scaffold boards, wooden/plastic pallets, plywood, chipboard, nails & screws, PE & PP plastics, flashing, decking, rubber, abrasive blocks, tar & mastic, flat roofing.

DO NOT USE ON CONCRETE, CERAMICS, MASONRY PRODUCTS OR THICK METAL.

Product Code	Diameter (mm)	Bore (mm)	List Price
KRB115/22	115	22.2	£49.90
KRB230/22	230	22.2	£119.90
KRB300/20	300	20	£169.90
KRB350/25/20	350	25.4/20	£209.90



CONTRACTOR CG6 – MORTAR RAKE

6mm wide segment. Entry level product for the cost conscious user.

APPLICATIONS

- Mortar raking, brick raking, abrasive materials.

Product Code	Diameter (mm)	Bore (mm)	List Price
CG6-115/22	115	22.2	£14.90
CG6-125/22	125	22.2	£16.90



TRADE XL MORTAR RAKING DIAMOND BLADE

6mm wide segment. Entry level product for the cost conscious user.

APPLICATIONS

- Mortar raking, brick raking, abrasive materials.

Product Code	Diameter (mm)	Bore (mm)	List Price
XL6-115/22	115	22.2	£17.12
XL6-125/22	125	22.2	£20.33



PREMIUM RD6 – MORTAR RAKE

6mm wide segment blade. Fantastic value for money product.

APPLICATIONS

- Mortar raking, brick raking, abrasive materials.

Product Code	Diameter (mm)	Bore (mm)	List Price
RD6-115/22	115	22.2	£30.36
RD6-125/22	125	22.2	£35.03



PRO RX6 – MORTAR RAKE

High quality 6mm wide segment blade. The market leader – a great product to use. Fast cut/long life.

APPLICATIONS

- Mortar raking, abrasive materials.

Product Code	Diameter (mm)	Bore (mm)	List Price
RX6-115/22	115	22.2	£69.40
RX6-125/22	125	22.2	£79.40
RX6-180/22	180	22.2	£99.40



TRADE XL SD – CERAMICS

Continuous rim diamond blade for cutting ceramic tiles.
Popular sizes.

APPLICATIONS

- Ceramic tiles.

Product Code	Diameter (mm)	Bore (mm)	List Price
SD115/22	115	22.2	£7.40
SD180/25/22	180	22.2	£17.40



PRO SM – CERAMICS

Continuous superior blade for cutting ceramic tiles.
All sizes from 100mm - 230mm.

APPLICATIONS

- Ceramic and medium hard natural stone tiles.

Product Code	Diameter (mm)	Bore (mm)	List Price
SM100/16	100	16	£11.10
SM115/22	115	22.2	£13.20
SM125/22	125	22.2	£15.90
SM150/25/22	150	25.4/22.2	£22.90
SM230/25/22	230	25.4/22.2	£34.40

PRO 2CM - 2CM PORCELAIN TILES



Mesh segment design - ensures minimal chipping of material during cutting.

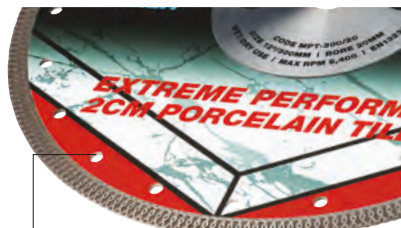

Cooling holes for fast effective heat reduction to ensure stability of the centre plate whilst cutting extremely hard materials.



Fast cutting - unique diamond segment ensures swift and smooth cutting, making it easier and more accurate. Suitable for wet and dry cutting.

APPLICATIONS

- Guaranteed to cut porcelain, all hard stone and all ceramic tiles.



CHECK OUT THE YOUTUBE TUTORIAL HERE

Product Code	Diameter (mm)	Bore (mm)	List Price
2CM-115/22	115	22.2	£14.93
2CM-125/22	125	22.2	£17.36
2CM-180/25/22	180	25.4/22.2	£32.29
2CM-200/25/22	200	25.4/22.2	£36.45
2CM-230/22	230	22.2	£41.31
2CM-250/25	250	25.4	£49.99
2CM-300/20	300	20	£84.71
2CM-350/25/20	350	25.4/20	£100.68





PRO SL-PRO - ALL TILES...GUARANTEED!

Featuring 8mm continuous rim, fine cut, high concentration, s-slot cool cutting, s-detensio silencing.

Cuts all tiles – guaranteed.

APPLICATIONS

- Ceramic tiles, natural stone, porcelain, granite, marble.

Product Code	Diameter (mm)	Bore (mm)	List Price
SL080/22/15	80	22.2/15	£17.97
SL105/22/16	105	22.2/16	£18.78
SL115/22	115	22.2	£20.40
SL125/22	125	22.2	£22.04
SL150/25/22	150	25.4/22.2	£31.83
SL180/25/22	180	25.4/22.2	£36.73
SL200/25/22	200	25.4/22.2	£42.45
SL230/25/22	230	25.4/22.2	£50.61
SL250/25	250	25.4	£66.12
SL300/25/20	300	25.4/20	£79.99
SL350/25	350	25.4	£102.04



PRO LST - FINE TURBO PORCELAIN

Super thin turbo with 7mm segment.
The finest cut for porcelain.

APPLICATIONS

- Porcelain, ceramic, natural stone, granite.

Product Code	Diameter (mm)	Bore (mm)	List Price
LST115/22	115	22.2	£22.67
LST125/22	125	22.2	£24.48
LST150/25/22	150	25.4/22.2	£31.83
LST180/25/22	180	25.4/22.2	£36.73
LST200/25/22	200	25.4/22.2	£47.17
LST230/25/22	230	25.4/22.2	£56.23
LST250/25	250	25.4	£73.47
LST300/25/20	300	25.4/20	£88.87
LST350/25	350	25.4	£113.37

TRADE XL CUTS ALL TILES DIAMOND BLADE



Multi purpose long life tile cutting blade for a precise, chip-free finish. Suitable for wet and dry cutting.

APPLICATIONS

- Ceramic and medium hard natural stone tiles.

Product Code	Diameter (mm)	Bore (mm)	List Price
CAT-115/22	115	22.2	£9.63
CAT-125/22	125	22.2	£11.00



PRO TK – TURBO CUP GRINDER

For stock removal, surface grinding and finishing. Universal applications. Transform your 4½" grinder into a handy diamond grinding machine.

APPLICATIONS

- Concrete and concrete products, natural stone, general building products.

Product Code	Diameter (mm)	Bore (mm)	List Price
TK100/22	100	22.2	£15.00

ULTIMATE KDR – DOUBLE CUP GRINDER

Professional double row cup grinder for universal concrete, construction products and stone. Long life.

APPLICATIONS

- Concrete, natural stone and construction products.

Product Code	Diameter (mm)	Bore (mm)	List Price
KDR105/22	105	22.2	£40.90
KDR115/22	115	22.2	£44.90
KDR125/22	125	22.2	£47.40
KDR180/22	180	22.2	£89.90



ULTIMATE PFC – FAN CUP GRINDING DISC

Professional fan cup grinding disc for universal concrete, construction products and stone. Long life.

APPLICATIONS

- Concrete, natural stone and construction products.

Product Code	Diameter (mm)	Bore (mm)	List Price
PFC105/22	105	22.2	£47.90
PFC115/22	115	22.2	£53.90
PFC125/22	125	22.2	£64.90
PFC150/19	150	19	£89.90



ULTIMATE MKT – TURBO CUP GRINDER

Extremely versatile wide turbo design for use with Makita PC1100. Also available in 22mm bore and M14 thread for angle grinders.

APPLICATIONS

- Concrete, and natural stone.

Product Code	Diameter (mm)	Bore (mm)	List Price
MKT105/22/15	105	22.2/15	£98.90



ULTIMATE KP – PLANING HEAD

250mm concrete planing heads with universal mounting configuration for most floor planers. Available in 10, 16 and 20 segments

APPLICATIONS

- Floor levelling, surface preparation and removal of adhesives, etc.

Product Code	Diameter (mm)	Bore (mm)	List Price
KP10-250	250	10	£109.90
KP16-250	250	16	£154.90
KP20-250	250	20	£199.90





SPECTRUM ULTIMATE DIAMOND BLADE - CURVE CUTTING

For cutting radii in concrete products and stone - Ideal for decorative patio work. Must have for landscape gardeners

APPLICATIONS

- Concrete products, slabs, natural stone, paving blocks.

Product Code	Diameter (mm)	Bore (mm)	List Price
LCRV115/22	115	22.2	£39.40
LCRV230/22	230	22.2	£79.40



PRO MCM TURBO - CORDLESS MACHINE

Blade designed for use with cordless machines, where speed, reduced dust and cable free working are required.

APPLICATIONS

- Concrete products, clay products, granite, engineering bricks, building products.

Product Code	Diameter (mm)	Bore (mm)	List Price
MCM115/22	115	22.2	£19.70



ULTIMATE USB - METAL CUTTING

The new way to cut ALL metals...FAST! suitable for hand held saws.

APPLICATIONS

- Ductile iron pipe, cast iron, rebar, steel, fibreglass, plastic pipe, concrete and general building materials. Can also be used for fine cutting of marble and other soft stone.

Product Code	Diameter (mm)	Bore (mm)	List Price
USB115/22	115	22.2	£29.40
USB230/22	230	22.2	£64.90
USB300/20	300	20	£98.90



SECTION 17

DRY CORE DRILLS





TRADE XL 3 CORE & ACCESSORIES CASE

Everything you need to get going with dry core drilling in a sturdy, aluminium case. Turbo segments increase cutting speed of the core. Spiral design draws dust away from the cutting edge, increasing speed and life of the diamond tip.

Product Code	Core diameter (mm)	List Price
XL3	38, 52, 117mm	£89.90



TRADE XL 5 CORE & ACCESSORIES CASE

Everything you need to get going with dry core drilling in a sturdy, aluminium case. Turbo segments increase cutting speed of the core. Spiral design draws dust away from the cutting edge, increasing speed and life of the diamond tip.

Product Code	Core diameter (mm)	List Price
XL5	38, 52, 65, 117, 127mm	£159.90



ULTIMATE MBX5 - DRY CORE CASE

Everything you need to get going with dry core drilling in a sturdy, aluminium case. Revolutionary BX10 long life dry core and HEX and SDS accessories. For more information on BX10 range see page 95..

ACCESSORIES

JX01, JS01, JB05, JB09, JB13, JB26

Product Code	Core diameter (mm)	List Price
MBX5	38, 52, 65, 117, 127mm	£328.70

PRO MS - DRY CORE CASE

Everything you need to get started with dry core drilling in a sturdy, aluminium case.

ACCESSORIES

JX01, JS01, JB05, JB09, JB13, JB26

Product Code	Core diameter (mm)	List Price
MS5	38, 52, 65, 117, 127mm	£179.70
MS3	38, 52, 117mm	£109.70





ADAPTORS 1/2" BSP (M)

Product Code	Description	List Price
JX01	HEX adaptor only	£9.90
JX31	HEX 250mm long adaptor	£19.90
JS01	SDS (plus) adaptor only	£10.90
JS25	SDS (plus) 250mm long adaptor	£20.90
JM01	SDS max adaptor only	£26.90
JBA12	½ x 20 UN(F) to ½" BSP(M) adaptor	£28.90
JBA58	¾ x 16 UN(F) to ½" BSP(M) adaptor	£28.90



ADAPTOR PACKS

Product Code	Description	List Price
JX03	HEX adaptor pack (JX01, JB09, JB05)	£19.90
JX03-13	HEX a taper drill adaptor pack (JX01, JB13, JB05)	£23.90
JS03	SDS adaptor pack (JS01, JB09, JB05)	£19.90
JS03-13	SDS a taper drill adaptor pack (JS01, JB13, JB05)	£23.90
JM03	SDS max adaptor pack (JM01, JB09, JB05)	£39.00

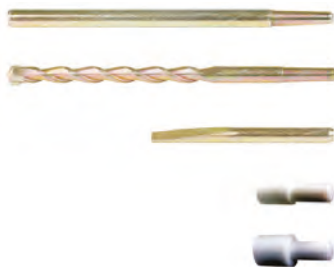

PILOTS & DRIFTS

Product Code	Description	List Price
JB09	12mm guide rod (X210mm)	£5.90
JB13	13mm a taper drill (X210mm)	£9.90
JB05	Drift key	£2.98
JB22	12mm plastic guide for 22mm core	£6.30
JB28	12mm plastic guide for 28mm core	£6.30

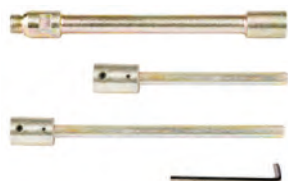

EXTENSIONS

Product Code	Description	List Price
JB26	½" BSP 250mm solid extension + a taper	£23.90
JB25	½" BSP 250mm hollow extension	£23.90
JX25	HEX 250mm extension (c/w allen key)	£16.90
JB04	4mm allen key for hex ext	£1.82
JB10	10 grub screws for hex ext	£4.54

PREMIUM BD – DRY CORE DRILL

Universal dry diamond core drill in all popular plumbers sizes up to 182mm. ½" BSP female thread takes Spectrum dry core accessories. Slotted barrel provides efficient dust clearance and ease of removing drilled core. For brick and blockwork.

APPLICATIONS

- Medium and soft bricks, concrete blocks (lightweight and dense), abrasive concrete products. Occasional use in harder materials e.g. semi engineering bricks and clay products.



Product Code	Dia (mm)	Length (mm)	Back End	List Price
BD022-HEX	22	300	HEX	£22.90
BD028-HEX	28	300	HEX	£23.90
BD032	32	150	½" BSP (F)	£24.50
BD038	38	150	½" BSP (F)	£25.50
BD048	48	150	½" BSP (F)	£29.90
BD052	52	150	½" BSP (F)	£30.50
BD065	65	150	½" BSP (F)	£32.90
BD078	78	150	½" BSP (F)	£35.90
BD091	91	150	½" BSP (F)	£39.50
BD102	102	150	½" BSP (F)	£41.90
BD107	107	150	½" BSP (F)	£43.90
BD117	117	150	½" BSP (F)	£46.90
BD127	127	150	½" BSP (F)	£48.90
BD142	142	150	½" BSP (F)	£58.30
BD152	152	150	½" BSP (F)	£64.90
BD162	162	150	½" BSP (F)	£79.90
BD172	172	150	½" BSP (F)	£82.90
BD182	182	150	½" BSP (F)	£89.90

ULTIMATE BX10 – DRY DIAMOND CORE

Universal dry core for long life in most building materials including semi-engineering bricks, clay products, and limestone aggregate concrete.

APPLICATIONS

- All bricks, concrete blocks, general building materials, lightly reinforced limestone aggregate concrete, most natural stone.



Product Code	Dia (mm)	Length (mm)	Back End	List Price
BX10-022-HEX	22	300	HEX	£42.00
BX10-022-BSP	22	300	½" BSP (F)	£42.00
BX10-028-HEX	28	300	HEX	£44.00
BX10-028-BSP	28	300	½" BSP (F)	£44.00
BX10-032	32	150	½" BSP (F)	£37.90
BX10-038	38	150	½" BSP (F)	£39.30
BX10-048	48	150	½" BSP (F)	£46.10
BX10-052	52	150	½" BSP (F)	£46.50
BX10-065	65	150	½" BSP (F)	£50.10
BX10-078	78	150	½" BSP (F)	£58.50
BX10-091	91	150	½" BSP (F)	£63.90
BX10-102	102	150	½" BSP (F)	£70.10
BX10-107	107	150	½" BSP (F)	£71.90
BX10-117	117	150	½" BSP (F)	£74.50
BX10-127	127	150	½" BSP (F)	£86.30
BX10-142	142	150	½" BSP (F)	£95.09
BX10-152	152	150	½" BSP (F)	£98.00
BX10-162	162	150	½" BSP (F)	£113.58
BX10-172	172	150	½" BSP (F)	£121.51
BX10-182	182	150	½" BSP (F)	£140.00
BX10-200	200	150	½" BSP (F)	£161.00

ULTIMATE BZX ZENITH - DRY CORE DRILL

The fastest core on the market guaranteed, will even drill hard concrete. With laser welded segments for ultimate strength the BZX is an incredibly versatile core, drilling almost anything including engineering and concrete.

APPLICATIONS

- All house bricks, engineering bricks, concrete blocks, general building materials, concrete, natural stone.



Product Code	Dia (mm)	Length (mm)	Back End	List Price
BZX-022	22	300	½" BSP (F)	£58.00
BZX-028	28	300	½" BSP (F)	£60.00
BZX-032	32	150	½" BSP (F)	£62.00
BZX-038	38	150	½" BSP (F)	£68.00
BZX-048	48	150	½" BSP (F)	£74.00
BZX-052	52	150	½" BSP (F)	£88.00
BZX-065	65	150	½" BSP (F)	£108.00
BZX-078	78	150	½" BSP (F)	£128.00
BZX-091	91	150	½" BSP (F)	£138.00
BZX-102	102	150	½" BSP (F)	£158.00
BZX-107	107	150	½" BSP (F)	£168.00
BZX-117	117	150	½" BSP (F)	£178.00
BZX-127	127	150	½" BSP (F)	£188.00
BZX-142	142	150	½" BSP (F)	£208.00
BZX-152	152	150	½" BSP (F)	£228.00
BZX162	162	150	½" BSP (F)	£248.00

PREMIUM EPX – DIAMOND HOLESAW

Fast, fine cutting of marble, ceramics and stone. Low cost for the occasional user. Straight shank for use in 3 jaw chuck. Recommended for use with water feed and guide.



Product Code	Diameter (mm)	List Price
EPX-06	6	£8.49
EPX-08	8	£9.45
EPX-10	10	£11.32
EPX-15	15	£14.15
EPX-20	20	£17.92
EPX-25	25	£19.81
EPX-30	30	£23.58
EPX-35	35	£28.29
EPX-40	40	£30.18
EPX-45	45	£33.96
EPX-50	50	£37.73
EPX-55	55	£44.32
EPX-60	60	£49.99
EPX-65	65	£53.77
EPX-70	70	£57.53
EPX-75	75	£60.37
EPX-80	80	£64.15

JP – HOLESAW ACCESSORIES

6 – 76mm suction guide for accurate positioning.

Product Code	Diameter (mm)	List Price
JP76	6-76mm UNIVERSAL SUCTION GUIDE	£23.58



PRO XT1 – DIAMOND DRILL

Fast drilling, long life diamond drills supplied with unique water container for accurate positioning and cooling of the diamond tip. Superfast drilling and core ejection. Quick change 6.3 standard hex shank. Precision drilling. **GUARANTEED TO DRILL ALL TILES, porcelain, ceramics, granite, glass, quarry, everything!**



Product Code	Diameter (mm)	List Price
XT1-05	5	£15.42
XT1-10	10	£23.58
XT1-12	12	£25.40
XT1-15	15	£27.21
XT1-20	20	£29.03
XT1-25	25	£31.75
XT1-30	30	£36.28
XT1-35	35	£39.91

PREMIUM DIAMOND DRILL - DRY

APPLICATIONS

- Super grade diamond for precise fast cutting.
- Self lubricating (waxed filled centre).
- Improved super-fast drilling speed.
- Drills all tiles including porcelain, marble, granite & ceramic.
- Works without water.
- Universal chuck fitting (including cordless).



Product Code	Diameter (mm)	List Price
TDD-05	5.5	£14.84
TDD-06	6	£15.18
TDD-07	7	£15.53
TDD-08	8	£15.87
TDD-10	10	£16.22
TDD-12	12	£16.55
TDD-18	18	£18.19
TDD-25	25	£19.51
TDD-35	35	£24.80

PREMIUM M14 DRY CUT DIAMOND TILE DRILL

APPLICATIONS

- Vacuum brazed diamond tip
- High-speed drilling
- Long life
- M14 fitting for use with angle grinders
- Suitable for use on all tiles and porcelain including Grade 5



Product Code	Diameter (mm)	List Price
MTD-06	6	£15.18
MTD-07	7	£15.53
MTD-08	8	£15.87
MTD-10	10	£16.22
MTD-12	12	£16.55
MTD-14	14	£17.66
MTD-25	25	£19.51
MTD-35	35	£24.80
MTD-44	44	£29.53
MTD-52	52	£35.31
MTD-75	75	£51.30
MTD-91	91	£62.27
MTD-102	102	£68.05
MTD-125	125	£88.60





Laser welded
rooftop' segment

ULTIMATE PCX-S - ½" BSP WET CORE

Ultimate wet diamond core drill for professional hand held and rig mounted use. ½" BSP (male) back end. 300mm drilling length. 10mm segment height. Universal/ all concrete.

APPLICATIONS

- Flint and limestone aggregate concrete; reinforced concrete; universal building products.

Product Code	Diameter (mm)	List Price
PCX-S014	14	£45.80
PCX-S016	16	£46.40
PCX-S018	18	£47.30
PCX-S020	20	£48.00
PCX-S022	22	£49.50
PCX-S024	24	£52.90
PCX-S025	25	£53.30
PCX-S028	28	£56.30
PCX-S030	30	£57.80
PCX-S032	32	£59.30
PCX-S036	36	£68.30
PCX-S040	40	£72.00
PCX-S045	45	£78.80
PCX-S052	52	£77.30



Laser welded rooftop segment

ULTIMATE PCX-N - 1½" UNC WET CORE

Ultimate wet diamond core drill for professional rig mounted use. 1½" UNC (female) back end. 450mm drilling length. 10mm segment height. Universal/all concrete.

APPLICATIONS

- Flint and limestone aggregate concrete; light to medium reinforced concrete; universal building products.

Product Code	Diameter (mm)	List Price
PCX-N052	52	£84.80
PCX-N056	56	£88.50
PCX-N062	62	£84.20
PCX-N065	65	£91.80
PCX-N072	72	£100.80
PCX-N076	76	£108.00
PCX-N082	82	£113.90
PCX-N087	87	£119.40
PCX-N092	92	£130.40
PCX-N102	102	£126.40
PCX-N107	107	£140.10
PCX-N112	112	£142.20
PCX-N117	117	£147.70
PCX-N122	122	£150.40
PCX-N127	127	£177.00
PCX-N132	132	£178.10
PCX-N142	142	£201.80
PCX-N152	152	£172.00
PCX-N162	162	£218.10
PCX-N172	172	£260.30
PCX-N182	182	£249.80
PCX-N200	200	£236.50
PCX-N225	225	£410.60
PCX-N250	250	£354.70
PCX-N300	300	£418.70



JN - WET CORE ACCESSORIES

Tough, durable adaptors and extensions for wet core drilling.

Product Code	Diameter (mm)	List Price
JN55	½" BSP(M) - ½" BSP(M) adaptor	£19.70
JN56	½" BSP(F) - ½" BSP(F) adaptor	£19.70
JN65	½" BSP(M) - 1½" UNC(M) adaptor	£19.70
JN66	½" BSP(F) - 1½" UNC(F) adaptor	£19.70
JNHAD3	½" BSP(F) - HILTI DD100/120/130/150 adaptor	£69.56
JNHAD4	½" BSP(F) / 1½" UNC(M) - HILTI DD100/120/130/150 adaptor	£69.56
JN25	½" BSP 250mm hollow extension	£22.90
JN20	1½" UNC 200mm extension	£24.90
JN30	1½" UNC 300mm extension	£29.70

RECOMMENDATION GUIDE

For specific advice, refer to your supplier

- ✓✓✓ Highly recommended
- ✓✓ Recommended (not continuous use)
- ✓ Occasional use
- ✗ Not recommended

CONSTRUCTION BLADES

BLADE REFERENCE	METAL	VERY HARD	CONCRETE	GENERAL PURPOSE	ABRASIVE	ASPHALT
	Exposed steel, RSJs and sheet metal	Granite, engineering bricks and hard clay products, hard Indian stone	Limestone and flint aggregate reinforced concrete, hard, unabrasive concrete products	Kerbs and slabs, medium hard bricks, yorkstone, concrete paviors	Concrete roof tiles, sandstone, abrasive concrete paviors	Asphalt, green concrete, render, cement screed, lignacite blocks
CGS	✗	✗	✓	✓✓✓	✓	✗
CG10	✗	✗	✓	✓✓✓	✓	✗
XL10	✗	✗	✓	✓✓✓	✓	✗
XLT	✗	✓✓	✓✓	✓✓✓	✗	✗
XLS	✗	✓	✓✓	✓✓✓	✓✓	✗
XLA	✗	✗	✓	✓✓✓	✓✓✓	✓
DX10	✓	✓✓✓	✓✓	✓✓✓	✗	✗
DCX-	✗	✗	✓✓	✓✓✓	✓✓	✗
DCA-	✗	✗	✓✓	✓✓✓	✓✓✓	✓
DA	✗	✗	✗	✗	✓	✓✓✓
TX10R	✓✓	✓✓✓	✓✓	✓✓✓	✗	✗
MX10	✗	✓✓✓	✓✓✓	✓✓✓	✓	✗
MCX	✗	✓✓	✓✓✓	✓✓✓	✓✓	✗
TCX15	✗	✓	✓✓✓	✓✓✓	✓✓	✗
MCA	✗	✓	✓✓✓	✓✓✓	✓✓✓	✓✓
MA	✗	✗	✗	✗	✓✓	✓✓✓
ZCX	✗	✓✓	✓✓✓	✓✓✓	✓	✗
ZX10	✗	✓✓✓	✓✓✓	✓✓✓	✗	✗
ZCA	✗	✓✓	✓✓✓	✓✓✓	✓✓✓	✓✓
ZA	✗	✗	✗	✗	✓	✓✓✓
MC	✗	✓	✓✓✓	✓✓✓	✓	✗
ZCF	✗	✓	✓✓✓	✓✓✓	✓✓✓	✗
ZRX	✗	✗	✓✓	✓✓✓	✓✓✓	✓✓✓
USB	✓✓✓	✓	✗	✗	✗	✗
MCM	✗	✓✓✓	✓	✓✓✓	✗	✗
BLADE REFERENCE	CERAMIC & STONE BLADES					
SL PRO	Continuous rim; s-slots; GUARANTEED TO CUT ALL TILES					
LST PRO	Fine turbo rim; porcelain, granite, hard natural stone and ceramics					
ZCM PRO	Unique diamond segment, guaranteed to cut porcelain, all hard stone and all ceramic tiles					

Recommendation guide only: for specific advice, please speak to a member of the technical support team.

SECTION 18

SAFETY & PPE





STANDARD SAFETY HELMET

FEATURES

- Lightweight helmet designed for general use
- Shell is manufactured from UV stabilized high density Polyethylene
- 6 point adjustable low density Polyethylene harness
- Fully adjustable slip ratchet headband
- Conforms to EN397

Product Code	Colour	Order Qty	Box Qty	List Price
OX-S245001	White	1	40	£5.95
OX-S245002	Yellow	1	40	£5.95
OX-S245003	Blue	1	40	£5.95



PREMIUM SAFETY HELMET

FEATURES

- Tough and functional helmet
- Shell is manufactured from UV stabilized high density Polyethylene
- 6 point Terylene harness with lip ratchet adjustment system
- Conforms to EN397

Product Code	Colour	Order Qty	Box Qty	List Price
OX-S245501	White	1	40	£7.95
OX-S245502	Yellow	1	40	£7.95
OX-S245503	Blue	1	40	£7.95



Comfort fit





FOLDING COLLAPSIBLE EAR DEFENDERS



SNR 29dB

FEATURES

- Lightweight, foldable general purpose ear defender
- Large sound absorbing acoustic foam filled cups
- Adjustable cup height is designed for greater versatility
- Conforms to EN352-1:2002

Product Code	Size	Order Qty	Box Qty	List Price
OX-S248930	One size fits all	1	40	£9.44



PREMIUM EAR DEFENDERS



SNR 25dB

FEATURES

- Both durable and ultra lightweight
- Broad foam cushions
- High impact ABS cups (filled with absorbing foam)
- Non magnetic
- Can be worn overhead, behind neck or under chin
- Conforms to EN352-1:2002

Product Code	Size	Order Qty	Box Qty	List Price
OX-S241901	One size fits all	1	20	£6.69



STANDARD EAR DEFENDERS



SNR 25dB

FEATURES

- Lightweight and robust protection
- Multiple position headband
- Large sound absorbing acoustic foam filled cups
- Non magnetic
- Can be worn overhead, behind neck or under chin
- Conforms to EN352-1:2002

Product Code	Size	Order Qty	Box Qty	List Price
OX-S241801	One size fits all	1	12	£5.34



DISPOSABLE EAR PLUGS - CORDED BOX OF 5 PAIRS



SNR 34dB

FEATURES

- Soft energy absorbing foam which compresses and then expands for a perfect fit in the ear canal
- Easy insertion and removal - tapered to fit
- Reduces sound to the ear drum whilst maintaining aural contact
- Corded to avoid dropping or loss and are visible when in use
- Conforms to EN352-2:2002

Product Code	Size	Order Qty	Box Qty	List Price
OX-S489105	-	20	20	£3.00



DISPOSABLE EAR PLUGS - UNCORDED BOX OF 5 PAIRS



SNR 38dB

FEATURES

- Soft energy absorbing foam which compresses and then expands for a perfect fit in the ear canal
- Easy insertion and removal - tapered to fit
- Reduces sound to the ear drum whilst maintaining aural contact
- Conforms to EN352-2:2002

Product Code	Size	Order Qty	Box Qty	List Price
OX-S489005	-	20	20	£2.00

DIRECT VENT SAFETY GOGGLES



FEATURES

- Soft vinyl flanges around the goggles to ensure comfort and conformity to facial contours
- Tough polycarbonate clear UV resistant lens
- Top and side perforations allow optimum air flow
- Direct ventilation through the frame
- Can be worn over prescription spectacles
- Conforms to EN166:1B

Product Code	Size	Order Qty	Box Qty	List Price
OX-S244601	One size fits all	1	200	£3.25



INDIRECT VENT SAFETY GOGGLES

FEATURES

- Provides protection from liquid droplets or splashes, and large dust particles
- Tough polycarbonate clear UV resistant lens
- Indirect vents minimise lens misting
- Soft vinyl flanges around the head strap ensure comfort and conformity to facial contours
- Conforms to EN166:1B.3.4.9

Product Code	Size	Order Qty	Box Qty	List Price
OX-S244701	One size fits all	1	200	£3.50



Protects against liquid splash



DELUXE ANTI-MIST SAFETY GOGGLES

FEATURES

- Wide angle for improved visibility
- Polycarbonate anti-mist lens
- Wide elastic headband for added comfort
- Integral moulded vent for protection against dust, liquid splashes and molten metal.
- Conforms to EN 166:1B.3.4.9

Product Code	Size	Order Qty	Box Qty	List Price
OX-S245201	One size fits all	1	10	£8.00

High quality



VISITOR SAFETY SPECTACLES

FEATURES

- A wrap around shield for protection against low energy and high speed impacts
- Wrap around panoramic vision
- Comfortable wide frame and brow shield gives improved all round protection
- Ultra light weight these spectacles can be worn over most prescription glasses
- Clear polycarbonate UV resistant construction
- Conforms to EN166:1F

Product Code	Size	Order Qty	Box Qty	List Price
OX-S248301	One size fits all	1	100	£2.35



Clear

Smoked



PROFESSIONAL WRAP AROUND SAFETY GLASSES

FEATURES

- Soft flexible nose pad and rubber temple tips ensure comfortable
- Dual cured lens provide uncompromised wide vision and protection
- Blocks 99.9% of UV radiation
- Conforms to EN166:1F

Product Code	Colour	Order Qty	Box Qty	List Price
OX-S248101	Clear	1	200	£8.95
OX-S248102	Smoked	1	200	£8.95



○ Clear ● Smoked

SAFETY GLASSES

FEATURES

- Sleek styling and lightweight design
- Padded temples ensure comfortable wear
- Polycarbonate lenses provide protection from impact and block harmful UV rays
- Conforms to EN166:1F
- Available with clear or smoked lenses

Product Code	Colour	Order Qty	Box Qty	List Price
OX-S241701	Clear	1	300	£3.25
OX-S241702	Smoked	1	300	£3.25



POLYCARBONATE FACE SHIELD

FEATURES

- A good all round lightweight brow guard with a polycarbonate face shield
- Provides unrestricted working vision and protection against medium energy flying particles and liquid splashes
- Adjustable head harness ensures comfortable fit and greater versatility
- Wheel ratchet adjustment for ease of use
- Size universal
- Conforms to EN166 1B

Product Code	Size	Order Qty	Box Qty	List Price
OX-S248701	One size fits all	1	40	£6.00



TWIN HALF MASK RESPIRATOR

FEATURES

- A general purpose half mask offering maximum protection and comfort
- Extra wide sealing surface to give unparalleled comfort and fit
- Low resistance exhalation valve
- Wide adjustable elastic strap for a perfect fit
- Low profile angular filter design for minimum visual impairment
- Maintenance free semi disposable mask supplied complete with filter cartridges
- There is no need to keep COSHH records when using this mask
- The mask can be used until the filters expire or up to 28 days whichever occurs first
- Manufactured from hypo-allergenic, odour free, medical grade PVC
- Conforms to EN405

Product Code	Size	Order Qty	Box Qty	List Price
OX-S247801	One size fits all	1	10	£18.00



450 HALF MASK RESPIRATOR

FEATURES

- Professional twin cartridge half mask
- Unique low resistance exhalation valve for easy breathing
- Durable thermoplastic rubber mask for superior fit to most face shapes for extra comfort
- 4 Point suspension harness with quick release buckles
- Reflective stripes on harness for increased visibility in low light environments
- Conforms to EN140:1998
- Replacement cartridges available to be purchased separately

Product Code	Size	Order Qty	Box Qty	List Price
OX-S481901	One size fits all	1	10	£15.00

TWIN FILTER CARTRIDGES - P2, P3, ABEK1

FEATURES

- 2 Packs of replaceable cartridges for the OX S450 Half Mask
- P2 Dust Cartridges, P3 Dust Cartridges and ABEK1 Gas & Vapour cartridges

	P2	P3 R	ABEK1
CODE	OX-S482002	OX-S482103	OX-S483201
PROTECTION TYPE	PARTICULATE PROTECTION ONLY	PARTICULATE PROTECTION ONLY	GAS & VAPOUR PROTECTION ONLY
APPLICATIONS	MEDIUM EXPOSURE RISK	HIGH EXPOSURE RISK	LOW CAPACITY SOLVENTS
CONSTRUCTION	SILICA	✓	
	CONCRETE & STONE CUTTING	✓	
	PLASTER	✓	
	RESINS		✓
FORMS	WELDING (FERROUS & LEAD)	✓	✓
	WOODS HARD	✓	✓
	WOODS SOFT	✓	✓
	ASBESTOS REMOVAL	✓	✓
	FIBRES & FIBRE GLASS	✓	✓
	WATER BASED	✓	✓
	BRUSH - SOLVENT BASED		✓
	POWERED PREP	✓	✓
	CHEMICAL PAINT STRIPPING		✓
	WHITE DRYWET		✓
	CHLORINE		✓
	GLYPHOSATE (WEED KILLER)	✓	
	BRICK ACID		✓

*W_{el} (Workplace exposure Level)
- This table is for guidance purposes only.
A proper risk assessment by qualified personnel
should be carried out before selecting an
appropriate filter cartridge.

Product Code	Type	Order Qty	Box Qty	List Price
OX-S482002	P2 Filter	1	10	£8.00
OX-S482103	P3 Filter	1	10	£12.00
OX-S483201	ABEK1 Filter	1	10	£16.00



P2 Filter



P3 Filter



ABEK1 Filter

S211 FFP2 NR MOULDED CUP RESPIRATOR

FEATURES

- Large cup shape design for comfort fit
- Soft latex straps to minimise irritation
- Adjustable nose bridge with internal nose pad to relieve pressure
- Conforms to EN149:2001 + A1:2009
- Assigned Protection factor of 10



Product Code	Pack Qty	Order Qty	Box Qty	List Price
OX-S486703	3	1	10	£3.83

S212 FFP2V NR MOULDED CUP RESPIRATOR

FEATURES

- Large cup shape design for comfort fit
- Soft latex straps to minimise irritation
- Adjustable nose bridge with internal nose pad to relieve pressure
- One way exhalation valve helps minimise moisture and heat build up
- Conforms to EN149:2001 + A1:2009
- Assigned Protection Factor of 10



Product Code	Pack Qty	Order Qty	Box Qty	List Price
OX-S488201	1	1	10	£1.61

S312 FFP3V MOULDED CUP RESPIRATOR

FEATURES

- Latex free elasticated straps
- Adjustable nose clip with foam ensures the correct fit whilst
- Offering greater comfort
- Large cup shape design for comfortable fit
- Exhalation valve reducing heat and moisture build up



Product Code	Pack Qty	Order Qty	Box Qty	List Price
OX-S489201	1	1	5	£3.83



S222 FFP2V FOLD FLAT VALVED RESPIRATOR

FEATURES

- Latex free elasticated straps
- Colour coded straps for easy identification - ffp1 = yellow, ffp2 = blue, ffp3 = red
- Adjustable nose clip with foam ensures the correct fit whilst offering greater comfort
- Fold flat design for easy and hygienic storage
- Exhalation valve reducing heat and moisture build up

Product Code	Pack Qty	Order Qty	Box Qty	List Price
OX-S489401	1	10	10	£1.40



OX S322 FFP3V FOLD FLAT VALVED RESPIRATOR

FEATURES

- Latex free elasticated straps
- Colour coded straps for easy identification - ffp1 = yellow, ffp2 = blue, ffp3 = red
- Adjustable nose clip with foam ensures the correct fit whilst offering greater comfort
- Fold flat design for easy and hygienic storage - Exhalation valve reducing heat and moisture build up

Product Code	Pack Qty	Order Qty	Box Qty	List Price
OX-S480001	1	10	10	£2.40



TYPE IIR FACE MASK

FEATURES

- Splash resistant protective layer to provide a barrier against fluids
- High bacterial filtration efficiency (BFE) > 98%
- Elastic ear loops allow universal size to fit all face shapes and sizes
- Dimensions : Length - 175 +/- 5 mm, Width (pleated) 90 +/- 5 mm, Width (Total) 170 +/- 5 mm
- Material : 65% Spun bonded non-woven, 35% Melt-blown non-woven, Latex-free, Fibreglass-free
- Product classification: Medical device acc. to MDD 93/42/ EEC
- Applied standards: EN 14683:2019, CE class 1
- Document Of Conformity and CE Certification available

Product Code	Pack Qty	Order Qty	Box Qty	List Price
OX-TYPEIIR/10	10	5	50	£1.50

Mask type		Filtration Efficiency	Brick Dust	Concrete	Ferrous Metal Fumes	Fibre Glass	Lead Fumes	MDF Dust	Mineral Fibres	Plaster	Rockwool	Stone	Silica	Softwood Dust	Hardwood Dust
FFP2	S211	92%	✓	✓	✓	✗	✗	✓	✗	✓	✓	✓	✗	✗	✓
FFP2V	S212	92%	✓	✓	✓	✗	✗	✓	✗	✓	✓	✓	✗	✗	✓
FFP3V	S312	98%	✓	✓	✓	✓	✓	✓	✓	✓	✓	✓	✓	✓	✓

Glove type	Abrasion Resistance					Cut Resistance	Tear Resistance	Puncture Resistance	Puncture Resistance (TDM)	Thermal/Cold Resistant	Scaffolding	Joinery	Bricklaying	Painting & Decorating	Inspection	Automotive	Plumbing	Electrics	General Assembly	Welding	Waterproof	Glass & Sheet Metal Handling
	4	2	2	1	X																	
Nitrile Disposable OX-5482208 (M) OX-5482209 (L) OX-5482210 (XL)	N/A					X	X	X	X	X	X	X	X	X	X	X	X	X	X	X	X	X
Foam Latex – Waterproof OX-5483809 (L) OX-5483810 (XL)	2	1	3	1	X	X	X	X	X	X	X	X	X	X	X	X	X	X	X	X	X	X
Foam Latex Thermal – Waterproof OX-5483909 (L) OX-5483910 (XL)	2	2	4	2	X	X	X	X	X	X	X	X	X	X	X	X	X	X	X	X	X	X
Thermal Latex Grip OX-5248410 (XL)	2	1	3	1	X	X	X	X	X	X	X	X	X	X	X	X	X	X	X	X	X	X
Latex Flex OX-5246209 (L) OX-5246210 (XL)	2	1	3	1	X	X	X	X	X	X	X	X	X	X	X	X	X	X	X	X	X	X
Pro Latex Grip OX-5246909 (L) OX-5246910 (XL)	2	1	4	2	X	X	X	X	X	X	X	X	X	X	X	X	X	X	X	X	X	X
Latex Grip OX-5241608 (M) OX-5241609 (L) OX-5241610 (XL) OX-5241611 (XXL)	2	1	3	1	X	X	X	X	X	X	X	X	X	X	X	X	X	X	X	X	X	X
Cut C Foam Latex OX-5484009 (L) OX-5484010 (XL)	3	X	4	2	C	X	X	X	X	X	X	X	X	X	X	X	X	X	X	X	X	X
PU Flex Cut C OX-5249209 (L) OX-5249210 (XL)	4	X	4	2	C	X	X	X	X	X	X	X	X	X	X	X	X	X	X	X	X	X
PU Flex OX-5241108 (M) OX-5241109 (L) OX-5241110 (XL) OX-5241111 (XXL)	3	1	2	1	X	X	X	X	X	X	X	X	X	X	X	X	X	X	X	X	X	X
Ultra Flex Nano Foam Nitrile Palm Glove OX-5488309 (L) OX-5488310 (XL)	3	1	2	1	X	X	X	X	X	X	X	X	X	X	X	X	X	X	X	X	X	X
White PU Flex Decorators OX-5484510 (XL)	3	1	2	1	X	X	X	X	X	X	X	X	X	X	X	X	X	X	X	X	X	X
Nitrile Flex OX-5249009 (L) OX-5249010 (XL)	4	1	2	1	X	X	X	X	X	X	X	X	X	X	X	X	X	X	X	X	X	X
PVC Knitwrist OX-5245709 (L) OX-5245710 (XL)	3	1	2	1	X	X	X	X	X	X	X	X	X	X	X	X	X	X	X	X	X	X
PVC Gauntlets OX-5246845 (XL)	3	1	2	1	X	X	X	X	X	X	X	X	X	X	X	X	X	X	X	X	X	X



100
BOX

NITRILE DISPOSABLE GLOVES 100 PK

FEATURES

- 100 Pack of powder free nitrile disposable gloves
- Ultra strong and flexible nitrile material for extra comfort and long life

Product Code	Size	Order Qty	Box Qty	List Price
OX-S488508	Medium	1	10	£10.59
OX-S488509	Large	1	10	£10.59
OX-S488510	X Large	1	10	£10.59



EN388



2142X

120
BOX

PRO LATEX GRIP GLOVES

FEATURES

- 10 Gauge high grade cotton liner
- High quality natural latex coating for long life & excellent grip
- Offers protection against snags, punctures, abrasions & cuts
- Conforms to EN388

Product Code	Size	Order Qty	Box Qty	List Price
OX-S246909	9 (Large)	12	120	£2.00
OX-S246910	10 (X Large)	12	120	£2.00



EN388



2131X

120
BOX

LATEX GRIP GLOVES

FEATURES

- Seamless Poly-cotton 10 gauge liner
- Open back for ventilation & ergonomic design that reduces hand fatigue
- Conforms to EN388

Product Code	Size	Order Qty	Box Qty	List Price
OX-S241608	8 (Medium)	12	120	£1.48
OX-S241609	9 (Large)	12	120	£1.48
OX-S241610	10 (X Large)	12	120	£1.48
OX-S241611	11 (XX Large)	12	120	£1.48



120
BOX

THERMAL GRIP GLOVES



FEATURES

- A warm acrylic 10 gauge liner so ideal for working in cold conditions
- Also suitable for more heavy outdoor tasks
- Conforms to EN388

Product Code	Size	Order Qty	Box Qty	List Price
OX-S248609	9 (Large)	12	120	£3.25
OX-S248610	10 (X Large)	12	120	£3.25



120
BOX

3121X

PU FLEX GLOVES

FEATURES

- Suitable for lighter duty applications
- The seamless 13 gauge knitted nylon liner has a PU palm & finger coating which provides excellent dexterity
- Conforms to EN388

Product Code	Size	Order Qty	Box Qty	List Price
OX-S241108	8 (Medium)	12	120	£1.48
OX-S241109	9 (Large)	12	120	£1.48
OX-S241110	10 (X Large)	12	120	£1.48
OX-S241111	11 (XX Large)	12	120	£1.48



120
BOX

4X42C

PU FLEX CUT C GLOVES



FEATURES

- Cut level C
- Combining cut resistance, comfort, dexterity and grip in a seamless PU palm dipped liner
- Conforms to EN388

Product Code	Size	Order Qty	Box Qty	List Price
OX-S249209	9 (Large)	12	120	£5.00
OX-S249210	10 (X Large)	12	120	£5.00



120
BOX

3121X

WHITE PU FLEX DECORATORS GLOVES

FEATURES

- Suitable for lighter duty applications
- The seamless 13 gauge knitted nylon liner has a PU palm & finger coating which provides excellent dexterity
- Conforms to EN388

Product Code	Size	Order Qty	Box Qty	List Price
OX-S484510	10 (X Large)	12	120	£1.48



COTTON DECORATORS GLOVES

FEATURES

- Suitable for general handling activities
- Secure and comfortable fit

Product Code	Size	Order Qty	Box Qty	List Price
OX-S484710	10 (X Large)	12	120	£1.48



PVC KNITWRIST GLOVES

FEATURES

- Fully coated red PVC cotton glove to protect against oil, grease and most household chemicals
- Resistant to abrasion and tears
- Knitted wristband protects against dust and infiltration
- Conforms to EN388

Product Code	Size	Order Qty	Box Qty	List Price
OX-S245709	9 (Large)	12	120	£1.38
OX-S245710	10 (X Large)	12	120	£1.38



PVC GAUNTLETS

FEATURES

- Fully coated red PVC Gauntlet with soft comfortable cotton lining
- PVC Coating has smooth finish for excellent abrasion resistance
- Longer length (450mm) gives forearm protection
- Conforms to EN388

Product Code	Size	Order Qty	Box Qty	List Price
OX-S246845	10 (X Large)	12	120	£3.00



NITRILE FLEX GLOVES

FEATURES

- Nitrile dipped palm designed for extra abrasion resistance
- Oil repellent coating
- Conforms to EN388

Product Code	Size	Order Qty	Box Qty	List Price
OX-S249009	9 (Large)	12	120	£1.48
OX-S249010	10 (X Large)	12	120	£1.48





FOAM LATEX GLOVES - WATERPROOF

FEATURES

- Fully dipped glove giving complete water resistance and protection to skin from oily substances, anti-slip sandy coating, great for light metal fabrication, part assembly and general handling
- Conforms to EN388

Product Code	Size	Order Qty	Box Qty	List Price
OX-S483809	9 (Large)	1	120	£4.95
OX-S483810	10 (X Large)	1	120	£4.95



FOAM LATEX THERMAL GLOVES - WATERPROOF



FEATURES

- Thermal glove for great warmth in cold external conditions, fully dipped giving complete water resistance and protection to skin from oily substances, anti-slip sandy coating, great for light metal fabrication, parts assembly and general handling
- Conforms to EN388 & EN511

Product Code	Size	Order Qty	Box Qty	List Price
OX-S483909	9 (Large)	1	120	£5.95
OX-S483910	10 (X Large)	1	120	£5.95



FOAM LATEX CUT C GLOVES



FEATURES

- Cut level C anti-cut, anti-slip, waterproof, ultra comfortable glove for sheet metal handling, glass cutting, sharp small parts handling, general assembly
- Conforms to EN388

Product Code	Size	Order Qty	Box Qty	List Price
OX-S484009	9 (Large)	12	120	£7.95
OX-S484010	10 (X Large)	12	120	£7.95



LATEX FLEX GLOVES

FEATURES

- Very lightweight flexible glove, with superior grip for Component handling, general assembly, electronics, light engineering works, joinery, plumbing, automotive and inspection
- Conforms to EN388

Product Code	Size	Order Qty	Box Qty	List Price
OX-S484209	9 (Large)	12	120	£1.78
OX-S484210	10 (X Large)	12	120	£1.78



EN388



4131X

ULTRA FLEXI NANO FOAM NITRILE PALM GLOVE

FEATURES

- Excellent resistance to abrasion with good resistance to tears
- Breathable nitrile coating
- Nylon/Spandex liner for added comfort and fit
- Lightweight with good dexterity
- Offers excellent dry and wet grip

Product Code	Size	Order Qty	Box Qty	List Price
OX-S488309	9 (Large)	12	120	£3.00
OX-S488310	10 (X Large)	12	120	£3.00



PPE KIT

FEATURES

- The OX PPE kit bag containing safety gloves, glasses, FFP3V mask and ear plugs
- Sleek styling and lightweight design clear sunglasses
- Moulded cup respirator with exhalation valve reducing heat and moisture build up
- Very lightweight latex flexible glove, with superior grip for component handling, general assembly, electronics, light engineering works, joinery, plumbing, automotive and inspection

Product Code	Size	Order Qty	Box Qty	List Price
OX-S489304	-	1	N/A	£11.99



HEAVY DUTY SOFT GEL KNEE PADS

FEATURES

- Ergonomic shape for stability and comfort for use over long periods
- Anti compression air injected gel and foam EVA core for maximum cushioning
- Perforated neoprene lining to keep away moisture
- One size fits all
- Easy positioning of knee pad

Product Code	Size	Order Qty	Box Qty	List Price
OX-S246201	One size fits all	1	24	£25.00



TRADE FOAM POCKET KNEE PAD

FEATURES

- Reinforced EVA foam
- Lightweight and hardwearing
- Pocket knee pad for workwear trousers

Product Code	Size	Order Qty	Box Qty	List Price
OX-W551601	One size fits all	1	50	£7.36



WATERPROOF RAINUIT

FEATURES

- Durable PVC jacket & over trousers
- Zip fastened jacket, concealed hood
- Elasticated inner cuffs
- Front pockets
- Ventilated back
- Trousers with elasticated waist & stud adjustable ankle width
- Fully taped seams



Product Code	Size	Order Qty	Box Qty	List Price
OX-S249702	Black - Medium	1	20	£22.00
OX-S249703	Black - Large	1	20	£22.00
OX-S249704	Black - X Large	1	20	£22.00
OX-S249705	Black - XX Large	1	20	£22.00
OX-S249802	Yellow - Medium	1	20	£22.00
OX-S249803	Yellow - Large	1	20	£22.00
OX-S249804	Yellow - X Large	1	20	£22.00
OX-S249805	Yellow - XX Large	1	20	£22.00



PP DISPOSABLE COVERALL

FEATURES

- Single use coverall giving light protection from dirt and grease and dust
- 100% polypropylene
- Non woven coverall c/w elasticated wrists and ankles
- Minimal risk only

Product Code	Size	Order Qty	Box Qty	List Price
OX-S243701	S	1	50	£3.75
OX-S243702	M	1	50	£3.75
OX-S243703	L	1	50	£3.75
OX-S243704	XL	1	50	£3.75
OX-S243705	XXL	1	50	£3.75

Sizes:

	Chest girth	Body height
S	84-92cm	164-170cm
M	92-100cm	170-176cm
L	100-108cm	176-182cm
XL	108-116cm	182-188cm
XXL	116-124cm	188-194cm



TYPE 5/6 DISPOSABLE COVERALL

FEATURES

- This is a lightweight micro porous coverall
- Elasticated hood, wrists and ankles
- Cost effective barrier to dust and particles and a limited splash and spray barrier
- Conforms to EN 13982 & EN13034

Product Code	Size	Order Qty	Box Qty	List Price
OX-S243601	S	1	50	£4.82
OX-S243602	M	1	50	£4.82
OX-S243603	L	1	50	£4.82
OX-S243604	XL	1	50	£4.82
OX-S243605	XXL	1	50	£4.82

HI VISIBILITY VEST

FEATURES

- Made from 100% polyester
- Velcro front fastening and conforming reflective tape
- Conform to EN471 Class 2



Yellow Orange

Product Code	Size	Order Qty	Box Qty	List Price
OX-S242805	Yellow - S	1	100	£4.00
OX-S242806	Yellow - M	1	100	£4.00
OX-S242807	Yellow - L	1	100	£4.00
OX-S242808	Yellow - XL	1	100	£4.00
OX-S242809	Yellow - XXL	1	100	£4.00
OX-S242810	Yellow - XXXL	1	100	£4.00
OX-S242705	Orange - S	1	100	£4.00
OX-S242706	Orange - M	1	100	£4.00
OX-S242707	Orange - L	1	100	£4.00
OX-S242708	Orange - XL	1	100	£4.00
OX-S242709	Orange - XXL	1	100	£4.00
OX-S242710	Orange - XXXL	1	100	£4.00



AVAILABLE IN SIZES 5 - 13



Steel toe & midsole

SAFETY WELLINGTON BOOTS

FEATURES

- Steel toe & midsole
- Fuel oil resistant sole
- Antistatic footwear
- Protection against perforation at least 1100N
- Slip resistance on ceramic/stainless steel floors
- Complies to EN ISO 20345 S5+SRA

Product Code	Size	Order Qty	Box Qty	List Price
OX-S242405	UK 5 (EU 38)	1	5	£37.50
OX-S242406	UK 6 (EU 40)	1	5	£37.50
OX-S242407	UK 7 (EU 41)	1	5	£37.50
OX-S242408	UK 8 (EU 42)	1	5	£37.50
OX-S242409	UK 9 (EU 43)	1	5	£37.50
OX-S242410	UK 10 (EU 44)	1	5	£37.50
OX-S242411	UK 11 (EU 45)	1	5	£37.50
OX-S242412	UK 12 (EU 46)	1	5	£37.50
OX-S242413	UK 13 (EU 47)	1	5	£37.50



AVAILABLE IN SIZES 6 - 13



Steel toe & midsole

HONEY NUBUCK SAFETY BOOTS

FEATURES

- Complies to EN 20345 SBP FO SRC
- Steel toe and midsole
- Honey nubuck leather upper
- Goodyear welted sole
- Oil resistant sole
- Rugged design
- Comfortable inner sole

Product Code	Size	Order Qty	Box Qty	List Price
OX-S242506	UK 6 (EU 40)	1	10	£59.95
OX-S242507	UK 7 (EU 41)	1	10	£59.95
OX-S242508	UK 8 (EU 42)	1	10	£59.95
OX-S242509	UK 9 (EU 43)	1	10	£59.95
OX-S242510	UK 10 (EU 44)	1	10	£59.95
OX-S242511	UK 11 (EU 45)	1	10	£59.95
OX-S242512	UK 12 (EU 46)	1	10	£59.95
OX-S242513	UK 13 (EU 47)	1	10	£59.95



SECTION 19

WORKWEAR





TECH CREW T-SHIRT S - XXL

FEATURES

- Stretch fabric with wicking qualities
- Mesh centre back panel for breathability
- Raglan armhole for greater fit and freedom of movement
- Flatlocked seams for comfort and fit
- Reflective chest print for safety
- 190-200GSM – 92% Polyester, 8% Elastane

Product Code	Size	List Price
OX-W552002	Small/Grey	£28.02
OX-W552003	Medium/Grey	£28.02
OX-W552004	Large/Grey	£28.02
OX-W552005	X Large/Grey	£28.02
OX-W552006	XX Large/Grey	£28.02
OX-W551902	Small/Navy	£28.02
OX-W551903	Medium/Navy	£28.02
OX-W551904	Large/Navy	£28.02
OX-W551905	X Large/Navy	£28.02
OX-W551906	XX Large/Navy	£28.02



TECH CREW POLO SIZES S - XXL

FEATURES

- Ribbed collar and cuffs for secure fit
- Stretch fabric with wicking qualities for comfort
- Side vents for ease of movement
- OX branded buttons and badge
- 100% polyester

Product Code	Size	List Price
OX-W552302	Small	£30.83
OX-W552303	Medium	£30.83
OX-W552304	Large	£30.83
OX-W552305	X Large	£30.83
OX-W552306	XX Large	£30.83



CREW NECK T-SHIRT S - XXL

FEATURES

- Specially designed for the ultimate comfort fit
- Twin needle hem and cuffs
- 1x1 Ribbed collar with grosgrain bound back neck
- OX Tools branded badge at sleeve
- 200gsm 100% Cotton

Product Code	Size	List Price
OX-W550502	Small	£14.80
OX-W550503	Medium	£14.80
OX-W550504	Large	£14.80
OX-W550505	X Large	£14.80
OX-W550506	XX Large	£14.80



TUFF CLUB CREW NECK T SHIRT BLACK S - XXL

FEATURES

- Specially designed for the ultimate comfort fit
- Tuff Club logo on chest
- Made from 160GSM, 97% Cotton and 3% Elastane

Product Code	Size	List Price
OX-W554602	Small	£15.00
OX-W554603	Medium	£15.00
OX-W554604	Large	£15.00
OX-W554605	X Large	£15.00
OX-W554606	XX Large	£15.00



CLASSIC CREW NECK T SHIRT GREY MARL S - XXL

FEATURES

- Slim fit design for the ultimate comfort fit
- Round neckline with a finely ribbed trim
- Flat-locked seam construction for extra durability and comfort
- 160gsm 97% Cotton 3% Elastane

Product Code	Size	List Price
OX-W554702	Small	£15.00
OX-W554703	Medium	£15.00
OX-W554704	Large	£15.00
OX-W554705	X Large	£15.00
OX-W554706	XX Large	£15.00



ULTRA COMFORT POLO SHIRT BLUE S - XXL

FEATURES

- Regular-fit polo shirt in soft melange interlock-premium cotton
- Ribbed collar with two buttons placket and short sleeves with ribbed cuff and internal rib tipping
- Curved back hem with side slits construction for comfort fit
- 210GSM in 100% premium cotton

Product Code	Size	List Price
OX-W554802	Small	£30.00
OX-W554803	Medium	£30.00
OX-W554804	Large	£30.00
OX-W554805	X Large	£30.00
OX-W554806	XX Large	£30.00



ULTRA ENGINEERED CREW T-SHIRT S - XXL

FEATURES

- Ultra-comfortable, breathable and stylish crew neck T-shirt
- Flatlock seam-to-seam construction for breathability and durability
- Made from 100% polyester 132gsm. Inserts 90% polyester 10% elastane – 118gsm

Product Code	Size	List Price
OX-W555102	Small/Black	£31.00
OX-W555103	Medium/Black	£31.00
OX-W555104	Large/Black	£31.00
OX-W555105	X Large/Black	£31.00
OX-W555106	XX Large/Black	£31.00
OX-W555202	Small/Navy	£31.00
OX-W555203	Medium/Navy	£31.00
OX-W555204	Large/Navy	£31.00
OX-W555205	X Large/Navy	£31.00
OX-W555206	XX Large/Navy	£31.00



ULTRA ENGINEERED V NECK T-SHIRT GREY S - XXL

FEATURES

- Ultra-comfortable, breathable and stylish V neck T-shirt
- Flatlock seam-to-seam construction for breathability and durability
- Made from 100% polyester 132gsm. Inserts 90% polyester 10% elastane – 118gsm

Product Code	Size	List Price
OX-W555302	Small	£31.00
OX-W555303	Medium	£31.00
OX-W555304	Large	£31.00
OX-W555305	X Large	£31.00
OX-W555306	XX Large	£31.00



CREW NECK SWEATSHIRT GREY SIZES S - XXL

FEATURES

- 2x1 rib trimmed round neckline with rib V-detail
- Elbow patches for increased protection and durability
- Flat-locked seams construction for extra durability and comfort
- Brushed back fleece for warmth
- 280GSM 80% cotton 20% polyester

Product Code	Size	List Price
OX-W554502	Small	£40.00
OX-W554503	Medium	£40.00
OX-W554504	Large	£40.00
OX-W554505	X Large	£40.00
OX-W554506	XX Large	£40.00

ULTRA ENGINEERED LONG SLEEVE TOP S - XXL

FEATURES

- Ultra-comfortable, breathable and stylish long sleeve top
- Flatlock seam-to-seam construction
- Made from 90% Nylon, 9% Elastane 1% Polyester -151gsm. Inserts 100% Polyester -132gsm

Product Code	Size	List Price
OX-W555402	Small/Light Grey	£35.00
OX-W555403	Medium/Light Grey	£35.00
OX-W555404	Large/ Light Grey	£35.00
OX-W555405	X Large/Light Grey	£35.00
OX-W555406	XX Large/Light Grey	£35.00
OX-W555502	Small/Grey	£35.00
OX-W555503	Medium/Grey	£35.00
OX-W555504	Large/Grey	£35.00
OX-W555505	X Large/Grey	£35.00
OX-W555506	XX Large/Grey	£35.00



HOODIE S - XXL

FEATURES

- Faux fur lined hood for extra warmth & protection
- Elasticated cuffs with thumbhole design
- Grosgrain drawcord pullers
- YKK zip for quality and durability
- Raglan armhole for maximum fit and comfort
- Breathable fabric with heat retention properties
- Heavyweight - brushed back fleece for comfort and warmth
- 300gsm 80% Cotton 20% Polyester Mix

Product Code	Size	List Price
OX-W550402	Small	£41.18
OX-W550403	Medium	£41.18
OX-W550404	Large	£41.18
OX-W550405	X Large	£41.18
OX-W550406	XX Large	£41.18





ZIP THROUGH HOODIE S - XXL

FEATURES

- Faux fur lined hood for extra warmth and protection
- YKK zipped pockets for security
- Grosgrain drawcord puller
- OX branded zip pullers for ease of use
- Elasticated cuffs with thumb grips
- 320gsm 80% Cotton 20% Polyester Mix

Product Code	Size	List Price
OX-W552902	Small	£49.42
OX-W552903	Medium	£49.42
OX-W552904	Large	£49.42
OX-W552905	X Large	£49.42
OX-W552906	XX Large	£49.42



ULTRA ENGINEERED HOODED FLEECE DARK FOREST S - XXL

FEATURES

- Ultra-comfortable, breathable and stylish hooded fleece
- Ribbed elasticated hem and cuffs
- Front pockets
- Body made from 86% Polyester 14% Elastane -256gsm. Inserts 90% Polyester 10% Elastane -118gsm

Product Code	Size	List Price
OX-W555602	Small	£60.00
OX-W555603	Medium	£60.00
OX-W555604	Large	£60.00
OX-W555605	X Large	£60.00
OX-W555606	XX Large	£60.00



ULTRA ENGINEERED HOODIE FULL S - XXL

FEATURES

- Ultra-comfortable, breathable and stylish full zip hoodie
- Ribbed elasticated hem and cuffs
- Front pockets
- Body made from 86% Polyester 14% Elastane -256gsm. Inserts 90% Polyester 10% Elastane -118gs

Product Code	Size	List Price
OX-W555702	Small/Dark Forest	£60.00
OX-W555703	Medium/Dark Forest	£60.00
OX-W555704	Large/Dark Forest	£60.00
OX-W555705	X Large/Dark Forest	£60.00
OX-W555706	XX Large/Dark Forest	£60.00
OX-W555802	Small/Grey	£60.00
OX-W555803	Medium/Grey	£60.00
OX-W555804	Large/Grey	£60.00
OX-W555805	X Large/Grey	£60.00
OX-W555806	XX Large/Grey	£60.00



Water Resistant



Thermal Qualities

SOFTSHELL JACKET S - XXL

FEATURES

- 3 Layer fabric to keep you comfortable in warm and cool conditions
- OX branded zip pullers for ease of use
- Microfleece backed softshell fabrication
- Easy access chest pocket
- 94% Polyester 6% Elastane for increased comfort fit

Product Code	Size	List Price
OX-W550102	Small	£55.48
OX-W550103	Medium	£55.48
OX-W550104	Large	£55.48
OX-W550105	X Large	£55.48
OX-W550106	XX Large	£55.48



RIBBED JACKET S - XXL

FEATURES

- Specially designed for the ultimate comfort fit
- Water resistant material providing protection against the elements
- Raglan armhole for maximum fit and comfort
- Ribbed panels - for body heat retention
- 100% Polyamide body
- 100% Polyester fill for extra warmth

Product Code	Size	List Price
OX-W550202	Small	£62.77
OX-W550203	Medium	£62.77
OX-W550204	Large	£62.77
OX-W550205	X Large	£62.77
OX-W550206	XX Large	£62.77



RIBBED GILET SIZES S - XXL

FEATURES

- Specially designed for the ultimate comfort fit
- Water resistant material providing protection against the elements
- Ribbed panels - for body heat retention
- OX branded zip pullers for ease of use
- Headphone eyelet on internal pocket
- 100% Polyamide body
- 100% Polyester fill for extra warmth

Product Code	Size	List Price
OX-W550302	Small	£53.80
OX-W550303	Medium	£53.80
OX-W550304	Large	£53.80
OX-W550305	X Large	£53.80
OX-W550306	XX Large	£53.80



TECH LIGHTWEIGHT FLEECE S - XXL

FEATURES

- Lightweight versatile mid layer fleece
- Ultra useful zipped utility pocket on sleeve
- Circle back fleece fabric for breathability and warmth
- Designed for the ultimate comfort fit
- High quality YKK zips

Product Code	Size	List Price
OX-W553602	Small	£39.04
OX-W553603	Medium	£39.04
OX-W553604	Large	£39.04
OX-W553605	X Large	£39.04
OX-W553606	XX Large	£39.04



PACKABLE LIGHTWEIGHT JACKET S - XXL

FEATURES

- Lightweight water resistant jacket with breathable properties
- Sealed internal seams with Airtex lining
- Integral hood folds away into the collar when not in use
- Packs conveniently into an integral internal storage bag located in the pocket
- 5 storage pockets for storage of small items such as wallets and keys
- YKK zips for quality and durability
- Velcro cuffs for a tight comfort fit
- Raglan sleeve design for ease of movement
- Reflective OX branded emblem on chest
- Bonded utility pocket on sleeve
- OX branded zip pullers
- 109GSM - 100% Polyester

Product Code	Size	List Price
OX-W553702	Small	£56.12
OX-W553703	Medium	£56.12
OX-W553704	Large	£56.12
OX-W553705	X Large	£56.12
OX-W553706	XX Large	£56.12



Water Resistant



Breathable



MULTI POCKET TRADE TROUSERS 32 - 40"

FEATURES

- Slim fit durable design
- 6 handy storage pockets suitable for storage of small items such as mobile phones/keys
- Mechanical stretch for flexibility and comfort
- Bar tacked reinforcement on stress areas for ultimate durability
- Internal bottom loading knee pad pockets suitable for use with OX trade foam kneepad. (Knee pad not included)
- 245GSM - 65% Polyester, 35% Cotton
- Regular length

Product Code	Size	List Price
OX-W556934	34"	£23.01
OX-W556936	36"	£23.01
OX-W556938	38"	£23.01
OX-W556940	40"	£23.01



HEAVY DUTY FLEX WAIST WORK TROUSERS 32 - 40"

FEATURES

- Two-way stretch twill construction for comfort
- Reinforced pockets with 500D Oxford nylon zip, water repellent & anti-rip structure
- Four & two-way stretch contrast panels in canvas and rib construction for extra comfort and movement
- 250GSM - 60% Cotton 38% Polyester 2% Spandex
- Regular length

Product Code	Size	List Price
OX-W554232	32"	£58.80
OX-W554234	34"	£58.80
OX-W554236	36"	£58.80
OX-W554238	38"	£58.80
OX-W554240	40"	£58.80



RIPSTOP TROUSERS 32 - 38"

FEATURES

- Reinforced ripstop anti-tear/anti-rip fabric
- Extra bartacks for strength and durability
- Advanced pocket formation for secure & comfortable tool storage
- Super-lightweight ultra-durable trousers
- Trade foam knee pad available - not included
- 65% Ripstop fabric, 35% Polyester, Cotton 220GSM
- Regular length

Product Code	Size	List Price
OX-W551132	32"/Graphite	£53.44
OX-W551134	34"/Graphite	£53.44
OX-W551136	36"/Graphite	£53.44
OX-W551138	38"/Graphite	£53.44
OX-W550936	36"/Beige	£53.44
OX-W550938	38"/Beige	£53.44



JOGGERS 32 - 40"

FEATURES

- Heavy duty brushed back fleece fabric for warmth and comfort
- Panelled crotch for the ultimate comfort fit & durability
- OX branded zip pullers for ease of use
- Black - 300GSM - 60% Cotton, 40% Polyester
- Grey - 300GSM - 75% Cotton, 20% Polyester, 5% Viscose
- 2x2 Ribbed waistband and cuffs for secure fit

Product Code	Size	List Price
OX-W550703	32"/Grey	£29.43
OX-W550704	34"/Grey	£29.43
OX-W550705	36"/Grey	£29.43
OX-W550706	38"/Grey	£29.43
OX-W550707	40"/Grey	£29.43
OX-W550803	32"/Black	£29.43
OX-W550804	34"/Black	£29.43
OX-W550805	36"/Black	£29.43
OX-W550806	38"/Black	£29.43
OX-W550807	40"/Black	£29.43



Comfort Fit



Thermal Qualities



ULTRA ENGINEERED JOGGER S - XXL

FEATURES

- Ultra-comfortable, breathable and stylish jogger Ribbed elasticated waistband, cuffs
- Zipped pockets
- Made from 86% Polyester 14% Elastane -256gsm

Product Code	Size	List Price
OX-W555902	Small/Dark Forest	£36.00
OX-W555903	Medium/Dark Forest	£36.00
OX-W555904	Large/Dark Forest	£36.00
OX-W555905	X Large/Dark Forest	£36.00
OX-W555906	XX Large/Dark Forest	£36.00
OX-W556002	Small/Grey	£36.00
OX-W556003	Medium/Grey	£36.00
OX-W556004	Large/Grey	£36.00
OX-W556005	X Large/Grey	£36.00
OX-W556006	XX Large/Grey	£36.00



Comfort Fit



Thermal Qualities



JOGGER SHORTS 32 - 40"

FEATURES

- Snap fastening mobile phone back pocket
- Brushed back fleece for extra comfort and warmth
- OX branded elasticated waistband for extra comfortable fit
- OX branded heavyweight cotton drawcords
- Reflective OX head logo on thigh
- Black - 60% cotton 40% polyester
- Grey - 75% cotton 20% polyester 5% Viscose
- Two front zip pockets for securely storage

Product Code	Size	List Price
OX-W553132	32"/Grey	£25.28
OX-W553134	34"/Grey	£25.28
OX-W553136	36"/Grey	£25.28
OX-W553138	38"/Grey	£25.28
OX-W553140	40"/Grey	£25.28
OX-W553232	32"/Black	£25.28
OX-W553234	34"/Black	£25.28
OX-W553236	36"/Black	£25.28
OX-W553238	38"/Black	£25.28
OX-W553240	40"/Black	£25.28

RIPSTOP SHORTS 30 - 38"

FEATURES

- Reinforced ripstop anti-tear/anti-rip fabric
- Super-lightweight ultra-durable shorts
- 65% Ripstop fabric, 35% Polyester, Cotton 195GSM



Product Code	Size	List Price
OX-W551330	30"/Graphite	£40.91
OX-W551332	32"/Graphite	£40.91
OX-W551334	34"/Graphite	£40.91
OX-W551336	36"/Graphite	£40.91
OX-W551338	38"/Graphite	£40.91



MULTI POCKET TRADE SHORTS 32 - 40"

FEATURES

- Slim fit durable design
- 6 handy storage pockets suitable for storage of small items such as mobile phones/keys
- Mechanical stretch for flexibility and comfort
- Bar tacked reinforcement on stress areas for ultimate durability
- 245GSM - 65% Polyester, 35% Cotton

Product Code	Size	List Price
OX-W556836	36"	£19.80
OX-W556838	38"	£19.80
OX-W556840	40"	£19.80

ULTRA ENGINEERED SHORT DARK FOREST S - XXL

FEATURES

- Ultra-comfortable, breathable and stylish shorts Elasticated waistband
- Back zip pocket
- Made from 86% Polyester 14% Elastane 256gsm



Product Code	Size	List Price
OX-W556102	Small	£28.00
OX-W556103	Medium	£28.00
OX-W556104	Large	£28.00
OX-W556105	X Large	£28.00
OX-W556106	XX Large	£28.00

INSULATED BEANIE

FEATURES

- OX Insulated beanie - One size fits all
- OX Woven label
- Available in Black or Grey



Product Code	Colour	List Price
OX-W556501	Black	£9.52
OX-W556601	Grey	£9.52

WINTER ESSENTIALS SET

FEATURES

- OX Insulated beanie - One size fits all
- OX Tough builders socks - Size 6-12
- OX Thermal grip gloves - Size 10 (X Large)



Product Code	Contains	List Price
OX-W557403	Beanie, Socks, Thermal Gloves	£23.98

HEAVY DUTY WORK SOCKS

FEATURES

- Specifically designed and recommended for STS steel toe cap safety shoes and boots, this pair of men's socks has a hard wearing reinforced heel and toe for durability
- The triple padded toe protects from chafing and blistering by steel toe caps
- With a fully cushioned foot, the cushioned sole of these chunky socks provide comfort against repetitive impact



Product Code	Size	Order Qty	Box Qty	List Price
OX-W551001	UK 6-11 (EU 39-45)	1	6	£11.21

BASE LAYER LONG SLEEVE TOP BLACK

FEATURES

- 4 way stretch fabric construction for comfort
- Ergonomically cut for ease of movement
- Flatlock and seam-to-seam construction for extra comfort
- Lightweight protection, underlayer
- 180GSM - 95% Polyester/5% Elastane



Product Code	Size	List Price
OX-W554903	Medium	£29.95
OX-W554904	Large	£29.95
OX-W554905	X Large	£29.95
OX-W554906	XX Large	£29.95

BASE LAYER LEGGING BLACK

FEATURES

- 4 way stretch fabric construction for comfort
- Ergonomically cut for ease of movement
- Flatlock and seam-to-seam construction for extra comfort
- Medium weight light protection underlayer
- 210GSM - 88% PES/12% Elastane



Product Code	Size	List Price
OX-W555003	Medium	£39.95
OX-W555004	Large	£39.95
OX-W555005	X Large	£39.95
OX-W555006	XX Large	£39.95

CONTACT US

OX GROUP UK SALES:

Address: OX TOOLS UK,
Osprey House, New Mill Road,
Crayfields Business Park,
Orpington, BR5 3QJ, UK

Telephone: 020 8676 9990

Email: sales.uk@oxtools.com

Web: oxtools.com

Please ask for details for your area sales manager.



ORDER DESPATCH & DELIVERY

OX Group UK have built up a reputation for excellence in customer service and care, with exceptionally high stock levels and an efficient fulfillment and despatch system. Our policy is 100% fulfillment of customer requirements.

Orders placed by 3.30pm will be despatched on guaranteed next day delivery – free on orders over £100.00 net. (Pallet orders to be placed by 1.30pm)

UK MAINLAND DELIVERY CHARGES:

Next day delivery.....	orders over £100 net.....	FREE
Next day delivery.....	orders £50-£100 net.....	£5.50
Next day delivery.....	orders under £50 net.....	£8.00
AM delivery.....	additional.....	£4.50
Before 10.30 delivery.....	additional.....	£16.00
Direct deliveries (to your customer)	additional.....	£6.00

Channel Islands, Isle of Man & Scottish Islands delivery charges:

48 Hour delivery	orders over £250 net.....	FREE
48 Hour delivery	orders £100-£250 net	£10.00
48 Hour delivery	orders £50-£100 net.....	£14.00
48 Hour delivery	orders under £50 net.....	£16.50

EIRE & Northern Ireland delivery charges - price on application.

All prices exclude VAT.

TERMS & CONDITIONS

The information in this catalogue contains copyrighted material and is for the sole use of OX Tools UK customers only, and may not be duplicated in any form without consent. Trademarks, including brand names and product names, are included as reference only and are acknowledged to be trademarks or registered trademarks of their respective holders. Although every effort has been made to verify accuracy of information herein, OX Tools UK's liability for errors/omissions is limited to replacement or credit of items and we cannot be responsible for incidental, indirect or consequential costs incurred unless by contractual agreement or state law. All prices are in GBP (£) and are subject to change. OX Tools UK reserves the right to limit quantities, adjust pricing, and remove items as availability and/or market conditions deem necessary.

TUFF CLUB

BECOME AN **OX TUFF CLUB** MEMBER TODAY!

The OX Tuff Club members community feeds directly back into the future of OX product innovation. With regular surveys and polls Tuff Club identifies what tradespeople want and need from their tools.

EVENTS, OFFERS & PROMOTIONS

Receive the latest news, event and special offer awareness notifications before anyone else.

PRODUCT TESTING OPPORTUNITIES

Take part in product testing and help shape the future of OX products.

COMPETITIONS, PRIZES & FREEBIES

Enter competitions for a chance to win fantastic prizes.

NEW PRODUCT NOTIFICATIONS

Be the first to hear about the latest new products.



**SIMPLY SCAN THE QR OR VISIT
WWW.OXTOOLS.CO.UK/TUFF-CLUB**





TUFF CLUB

JOIN AT WWW.OXTTOOLS.COM

**FOR ALL THE LATEST
PRODUCT INFORMATION,
INSIGHT AND BENEFITS.
JOIN THE TUFF CLUB.**



VISIT OXTTOOLS.COM
FOR DETAILS OF YOUR
LOCAL STOCKIST OF
OX TOOLS.