

>B< Press

>B< Press XL



>B< Press & >B< Press XL
Technical Brochure

Contents

1.1 General	1	2 >B< Press 12 to 54 mm	
1.1.1 Quality and certifications		2.1 >B< Press Fittings	13
1.1.2 Features and benefits		2.2 Fitting Construction	13
1.1.3 Materials and threads		2.3 Compatible Press Tools	14
1.1.4 Storage and handling		2.3.1 Tool chart	
1.1.5 Black EPDM sealing elements		2.3.2 Use of tools	
1.1.6 Unpressed Joint Indicator		2.4 Installation Requirements	15
1.1.7 System testing		2.4.1 Space required for the pressing process	
1.1.8 Electrical continuity		2.4.2 Insertion depth and minimum distances between pressings	
1.1.9 Recommended water velocities		2.4.3 Minimum distance for press fittings from an existing brazed joint	
1.1.10 COSHH (Control of substances hazardous to health)		2.4.4 Minimum brazing distance to an existing pressed fitting	
1.1.11 Tube compatibility		2.4.5 >B< Press tube compatibility table	
1.2 Applications	3	2.5 >B< Press Installation Process	17
1.3 Product Suitability.....	4	2.6 The Range	18
1.3.1 Drinking water installations		3 >B< Press XL 64 to 108 mm	
1.3.2 Heating and cooling systems		3.1 >B< Press XL Copper Fittings	38
1.3.3 Local, district and solar heating		3.1.1 Product features	
1.4 Thermal Expansion	4	3.1.2 Stainless steel grip ring	
1.4.1 Effects of expansion		3.1.3 Seal design	
1.4.2 Expansion devices		3.2 Compatible Press Tools	39
1.5 Corrosion Resistance, Frost / Heat Protection	6	3.2.1 Tool chart	
1.5.1 Frost protection and heat gain		3.3 Installation Requirements	39
1.6 Pressure Testing	6	3.3.1 Space required for the pressing process	
1.7 System Commissioning	6	3.3.2 Minimum distances between pressings	
1.7.1 Flushing of water installations		3.3.3 Minimum distance for press fittings from an existing brazed joint	
1.7.2 Water softening		3.3.4 Minimum brazing distance to an existing pressed fitting	
1.8 Loss Coefficients	8	3.3.5 >B< Press XL tube compatibility table	
1.9 Product Guarantee	10	3.4 >B< Press XL Installation Process	42
		3.5 The Range	43

1.1 General

>B< Press fittings are quick and easy to install and are available in copper and copper alloy. This flame-free range is designed with an innovative 3-point press system, with >B< Press XL (64 to 108 mm) featuring a stainless steel grip ring with both ranges featured a unpressed joint indicator feature.

1.1.1 Quality and certifications

Conex Bänninger has 110 years of experience in manufacturing innovative products and operates an accredited Quality Management System to EN ISO 9001.

>B< Press copper and copper alloy fittings are tested and certified by independent national certification bodies confirming its suitability and reliability for use with potable water applications. >B< Press is certified by the following bodies:

Table 1

International certifications	
>B< Press 12 to 54 mm	
Belgium	ATG
Czech Republic	SZU
France	ACS
France	CSTB
Germany	DVGW
Germany	DNV
Hungary	ANTSZ
Hungary	EMI
Marine	Lloyd's Register
Marine	Bureau Veritas
Netherlands	KIWA
Poland	ITB
Poland	PZH
Russia	PCT
Slovenia	Institut za varilstvo
Switzerland	SVGW
Sweden	KIWA SE
Ukraine	TYSK
United Kingdom	BSI Kitemark
United Kingdom	WRAS
>B< Press XL 64 to 108 mm	
Germany	DVGW
United Kingdom	BSI Kitemark
United Kingdom	WRAS

1.1.2 Features and benefits

- Suitable for potable water, hot and cold water installations, chilled water, compressed air and vacuum.
- Quick and easy to install, saving on labour time.
- Permanent, flame-free connection - no hot works permit required.
- Suitable for use with hard, half-hard and soft copper tubes to EN 1057. See tube compatibility table in section 2.4.5 for >B< Press and section 3.3.5 for >B< Press XL.
- Unpressed joint indicator identification of unpressed joints.
- Manufactured using high quality materials to applicable standards.
- Tested and approved by national and international standard authorities.
- Maximum operating pressure 16 bar.
- Twenty five year product guarantee, for full terms and conditions please see section 1.9.
- Maximum operating temperature 110 °C.
- 3-point press safety feature for added security (12 to 54 mm only).
- >B< Press XL has a stainless grip ring for additional strength (64 to 108 mm only).
- No soldering or brazing consumables required.
- Comprehensive range of fittings - sizes from 12 to 108 mm.
- Compatible with M profile jaws 15 to 28mm (Please see section 2.3)
- Compatible with m profile jaws 15 to 28mm (Please see section 2.3)
- Compatible with commonly available press tools (see section 2.3 for >B< Press and section 3.2.1 for >B< Press XL).
- Suitable for in built water installations.
- >B< Press XL flanges comply to EN 1092-1.

1.1.3 Materials and threads

>B< Press and >B< Press XL fitting bodies are produced from copper and copper alloy materials.

Copper fittings are made from oxygen-free copper CU-DHP (material number EN 12165 CW024A).

Copper alloy fittings are produced from Red brass (gunmetal): EN 1982, CC 499K.

All components in contact with water are manufactured from low lead materials complying with the European requirements for materials in contact with drinking water.

The materials meet the requirements of the 'UBA/4MS list of hygienically suitable materials for drinking water', and are ideal for all types of drinking water systems without restriction.

Threaded connections

>B< Press and >B< Press XL fittings are available with male and female threaded connections to the following standards:

- Joining threads are to ISO 7-1 and EN 10226-1. Female are parallel and male are taper.
- Fastening threads are to ISO 228 parallel.

1.1.4 Storage and handling

Store in a cool and dry place to protect the fittings from contamination, damage and dirt. Keep out of direct sunlight. Fittings should be left in their packaging to preserve the lubrication on the O-rings prior to installation.

1.1.5 Black EPDM sealing elements

>B< Press and >B< Press XL EPDM O-ring's are peroxide cured rubber seals with high elasticity, excellent cold and heat performance.

Please refer to section 1.2 for the fitting operating parameters for the different applications.

1.1.6 Unpressed Joint Indicator

>B< Press benefits from patented 'unpressed joint indicator' O-ring technology (12 to 54 mm) which indicates if a joint has not been pressed. The O-ring contains two in-built water pathways that allows water to pass through and create a noticeable leak when the system is tested at low pressure (0.1 to 6.0 bar).

>B< Press XL (64 to 108 mm) also features an in-built 'unpressed joint indicator' function. With a larger internal fitting diameter, water passes through and creates a leak path when the system is tested at low pressure (0.1 to 6.0 bar).



1.1.7 System testing

Pressure testing should be carried out to the appropriate standard (e.g. EN 806 1.1 x maximum working pressure) or to the satisfaction of the supervising engineer with a maximum test pressure of 1.5 times the operating pressure. For further information please see section 1.6.

1.1.8 Electrical continuity

>B< Press copper and red brass fittings maintain earth continuity without the need for additional continuity straps.

1.1.9 Recommended water velocities

Please note the maximum allowances for water velocities are per the relevant national standards and codes, which includes EN 806 part 2 and part 3.

1.1.10 COSHH

(Control of substances hazardous to health)

It is the responsibility of the end user to ensure that adequate protection is available where required and the necessary information regarding possible health and safety regulations is adhered to. Copper and copper alloy fittings are considered non-hazardous under normal circumstances.

1.1.11 Tube compatibility

>B< Press and >B< Press XL fittings can be used on hard, half-hard and soft copper tube to EN 1057. Also >B< Press red brass fittings can also be used to connect stainless steel tube in accordance with EN 10312. For >B< Press (12 to 54 mm) please refer to section 2.4.5 and for >B< Press XL (64 to 108 mm) see section 3.3.5.



1.2 Applications

>B< Press copper fittings are suitable for use in the following applications.

Table 2

Application	Flow medium	Pressure bar	Temp °C
Drinking water installations EN 806	Drinking water	10	95 max
		16	25 max
Hot water heaters EN 12828	Heating water	6	110 max
Local and district heating tubes	Heating and district heating water	10	110 max
Thermal solar systems* with permanent operating temperatures ≤ 110 °C EN 12975 / 12976	Water and water-glycol mixtures mixing ratio max. 50/50 %	6	Range -35 to 110 200 °C 20 h/a** 180 °C 60 h/a**
Chilled water and cooling water systems	Water and water-glycol mixtures mixing ratio max. 50/50 %	10	-10 min
Rainwater harvesting systems	Rainwater from cisterns	10	25
Compressed air (oil-free)	Compressed air classes 1-3 as per ISO 8573-1	10	25
Industrial and processing water	Prepared, softened, partially and partially de-ionized water with a pH of $6.5 \leq \text{Ph} 6.5 \leq 9.5$ ***	10	95 max
		16	25 max
Vacuum piping for non-medical purpose	N/A	-0.8	Ambient
Pipeline in shipbuilding ≤ 54 mm	Water with $6.5 \leq \text{Ph} 6.5 \leq 9.5$	16	95 max
Field test pressure	Water with $6.5 \leq \text{Ph} 6.5 \leq 9.5$	16	Ambient

* In thermal solar plants and district heating pipelines with permanently high operating temperatures, our >B< Press Solar press fittings (with the high temperature-resistant FKM sealing element) can be used.

** h/a - Hours per annum.

*** In the event of deviating parameters, please contact the technical department, technical@ibpgroup.com.

For applications outside those stated in the table above, please contact the technical department: technical@ibpgroup.com.

1.3 Product Suitability

The application parameters referred to in section 1.2 and the tube compatibility must be adhered to when using and connecting >B< Press copper and copper alloy fittings.

1.3.1 Drinking water installations

Drinking water installations must be planned and operated in accordance with local regulations, codes of practice, by laws and standards governing the installation e.g. EN 806: parts 1 to 4: Specifications for installations inside buildings conveying water for human consumption.

>B< Press copper and copper alloy fittings have several accreditations for use in drinking water systems see section 1.1.1.

A variety of tube materials including copper, internally tin-plated copper and stainless steel may all be combined in one system.

>B< Press red brass fittings can also be used to connect stainless steel tube in accordance with EN 10312.

1.3.2 Heating and cooling systems

In closed heating, cooling and chilled water systems, there is generally an absence of oxygen which greatly reduces the likelihood of corrosion. This means a range of metallic materials may be used without the risk of corrosion; flow direction does not need to be taken into consideration.

Consequently, >B< Press copper and copper alloy water fittings can be combined with other materials in a closed oxygen free system (reference EN 14868:2005).

Whilst, oxygen entry cannot always be fully prevented in extensive tube systems. EN 806 part 2 and 4 provide instructions for the measures to be taken in this case (chemical oxygen binding).

In the case of open vented systems, appropriate precautions should be taken with mixed metals to avoid any bi-metallic corrosion issues. You must ensure copper is installed downstream from galvanized steel components.

1.3.3 Local, district and solar heating

>B< Press can be used in local, district and solar heating systems with the operating parameters referred to in section 1.2. Please contact our technical team first if special additives need to be added to the hot water for corrosion protection or sealing purposes.

For permanent higher operating temperatures above 110 °C, it is recommended that >B< Press Solar fittings are used with the high temperature resistant, green FKM sealing element.

1.4 Thermal Expansion

1.4.1 Effects of expansion

The coefficient of linear expansion for copper is $16.8 \times 10^{-6} \text{ } ^\circ\text{C}$. For example, a 10 m length of copper tube, irrespective of its size, wall thickness or temper, will increase in length by 10.8 mm a temperature rise of 60 °C. Tubes installed on hot water services must be free to accommodate this expansion; otherwise stresses will build up in the pipework that may lead to joints being pulled apart and/or tubes fracturing. Clearly the magnitude and frequency of such changes in length will determine the life of the joint or failure of the tube.

Table 3 shows the amount of tube expansion for a given temperature rise. In the case of tube in domestic hot water and heating installations the limited size of rooms and hence straight tube runs, together with the many bends and offsets that normally occur, will result in thermal movement being accommodated automatically. However where long straight tube runs, exceeding 10 m, are encountered, allowance for expansion should be made.

A quick, economic and effective way of accommodating thermal expansion is to simply incorporate the horseshoe or compensating bend to the system design.

1.4.2 Expansion devices

Where copper tubes pass through walls, floors and ceilings, they should be able to move as a result of expansion and contraction. This can be arranged by passing the tube through a sleeve or length of larger diameter tube fixed through the whole thickness of the wall, floor, ceiling, or by means of flexible joints on either side of the wall.

Short stubs to and from radiators, connected to relatively long straight runs should also be avoided. This can usually be achieved by introducing an expansion loop, thereby increasing the length of pipework fixed between the flow/return legs and the radiator connection. However, expansion accommodation techniques such as the use of loops and horseshoes may not be sufficient to accommodate large expansions and in such cases the use of the bellows type couplers may be necessary.

Table 3 shows the increase in length due to thermal expansion as a function of change in temperature Δt and the length of the tube, irrespective of diameter, temper or wall thickness.

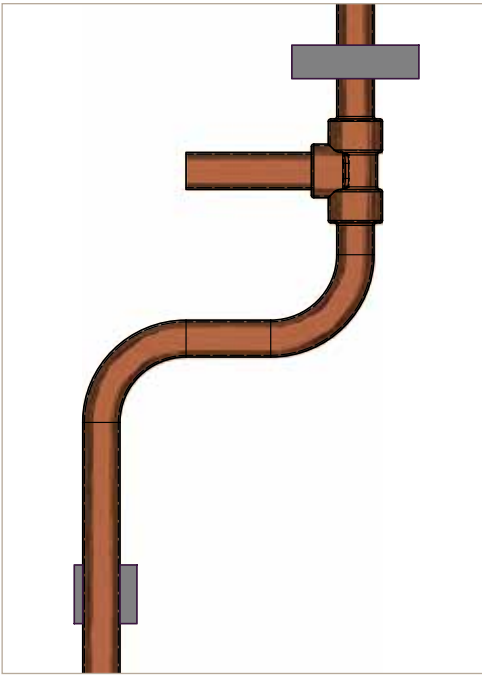

By change of direction

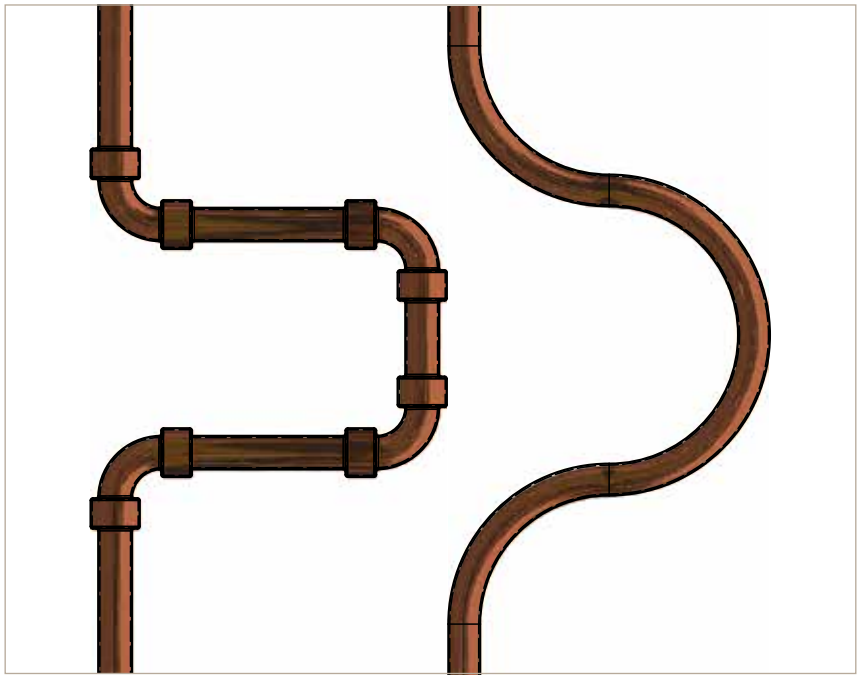

Horseshoe or compensating bend

Table 3

Tube length m	Change in length mm with temperature difference Δt °C							
	$\Delta t=30^\circ$	$\Delta t=40^\circ$	$\Delta t=50^\circ$	$\Delta t=60^\circ$	$\Delta t=70^\circ$	$\Delta t=80^\circ$	$\Delta t=90^\circ$	$\Delta t=100^\circ$
0.1	0.05	0.07	0.08	0.10	0.12	0.13	0.15	0.17
0.2	0.10	0.13	0.17	0.20	0.24	0.27	0.30	0.34
0.3	0.15	0.20	0.25	0.30	0.35	0.40	0.45	0.50
0.4	0.20	0.27	0.34	0.40	0.47	0.54	0.60	0.67
0.5	0.25	0.34	0.42	0.50	0.59	0.67	0.76	0.84
0.6	0.30	0.40	0.50	0.60	0.71	0.81	0.91	1.01
0.7	0.35	0.47	0.59	0.71	0.82	0.94	1.06	1.18
0.8	0.40	0.54	0.67	0.81	0.94	1.08	1.21	1.34
0.9	0.45	0.60	0.76	0.91	1.06	1.21	1.36	1.51
1.0	0.50	0.67	0.84	1.01	1.18	1.34	1.51	1.68
2.0	1.01	1.34	1.68	2.02	2.35	2.69	3.02	3.36
3.0	1.51	2.02	2.52	3.02	3.53	4.03	4.54	5.04
4.0	2.02	2.69	3.36	4.03	4.70	5.40	6.05	6.72
5.0	2.52	3.36	4.20	5.04	5.88	6.72	7.56	8.40
10.0	5.04	6.72	8.40	10.80	11.76	13.44	15.12	16.80
15.0	7.56	10.80	12.60	15.12	17.64	20.16	22.68	25.20
20.0	10.08	13.44	16.80	20.16	23.52	26.88	30.24	33.60
25.0	12.60	16.80	21.00	25.20	29.40	33.60	37.80	42.00

Δt dimensional increase is stated in mm

1.5 Corrosion Resistance, Frost / Heat Protection

1.5.1 Frost protection and heat gain

Regulations require that all water services (except warning or overflow pipes) shall be protected from freezing temperatures and heat gain. This is best achieved by protecting the system by use of a suitable thickness of insulation or in the case of particular situations such as unheated roof spaces that require special care, a self-regulating trace heating tape.

Pipework may need to be protected from external corrosion causing construction materials, corrosive environments or abrasion. A variety of solutions are available, ducting, insulation, corrosion resistant paint finishes and anti-abrasive tape, the most effective solution should be chosen.

Systems containing copper tube with copper and copper alloy fittings generally have a high resistance to internal corrosion. However, it is recommended when systems have been hydrostatically pressure tested and are not going into immediate service, they are fully drained down and blown out with dry air. Alternatively, if this is impracticable, the system should be left 'wet', and flushed at regular intervals prior to being commissioned to reduce carbon film cold water pitting and the potential for legionella in stagnant water.

Precautions against freezing must also be undertaken. This is particularly important in new build housing when properties are not occupied for extended periods.

For heating and cooling applications, >B< Press fittings can be used with glycol-water mixtures up to a mixing ratio of 50:50 without affecting the product quality and the sealing element.

If a frost protection inhibitor is to remain in the pipelines permanently, at least one concentration test must be carried out annually. All chemical additions must be agreed before use to rule out negative interactions with materials and sealing elements (O-rings). For more information, please contact Conex Bänninger technical department.

1.6 Pressure Testing

Pressure testing on >B< Press fittings should normally be carried out using clean potable water. Only in exceptional circumstances should pneumatic pressure testing using compressed inert gas or air be used, and then only under careful controlled conditions.

Pressure testing should be carried out in accordance with national regulations, appropriate specifications should be drawn up and a risk assessment must be completed prior to testing.

Typically, when testing systems containing >B< Press fittings, all joints shall remain uncovered and visible, the system shall be filled with clean potable water against an open high point valve allowing all trapped air to be removed from the network. Once free of trapped air, the high-level valve should be closed and the system topped up. At that stage testing can be completed between 1 to 2 bar and a full inspection made to ensure any un-pressed joints are identified. Any identified joints that have not been pressed and are leaking water can be pressed without draining down, however it is essential the tube is fully inserted to the tube stop prior to pressing.

Once it is confirmed there are no un-pressed joints, the pressure can be slowly raised to the system test pressure. The recommended system test pressure should be in accordance with the requirements of EN 806 part 4 (1.1 x maximum design pressure). Full test pressure should be maintained for a minimum of 30 minutes without any sign of pressure drop. A full inspection should then be carried out to identify any leaks.

1.7 System Commissioning

To ensure the quality and safety of hot and cold-water supply systems always follow best practice techniques in their design, installation, commissioning, and maintenance.

A reliable and predictive regime of commissioning that does not have any detrimental effect on the longevity of the system should be in place as required by national, regional and local laws and regulations.

The chemicals used in the pre-commissioning, if incorrectly administered can have a serious effect on the systems' life, therefore the choice of chemicals is

dependent on the particular site conditions, the materials used and the method(s) of construction.

Where a temporary mains supply(s) is to be used it should be cleaned and chlorinated in accordance with national regulations before being used for system filling and flushing.





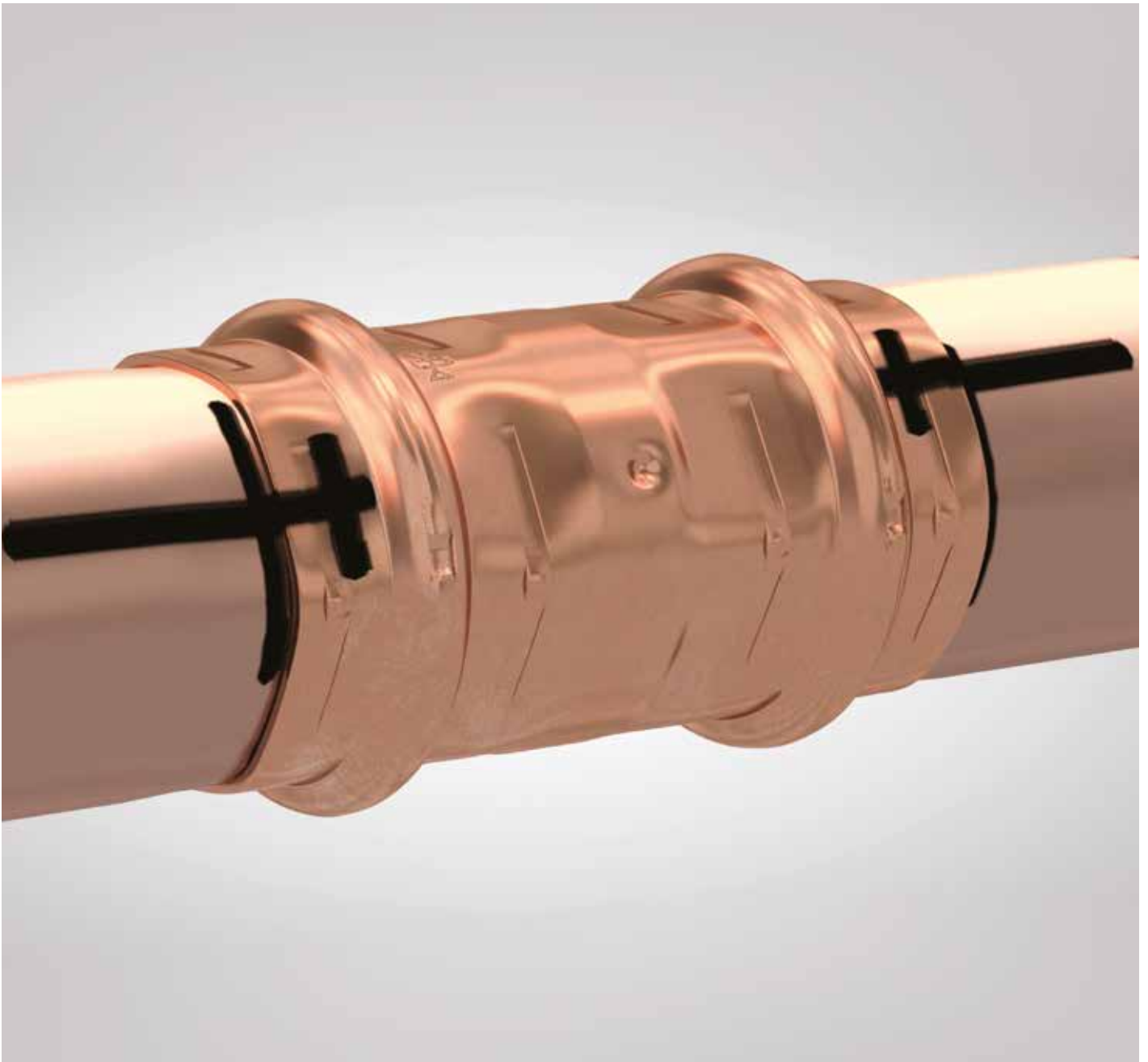





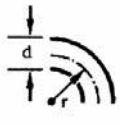
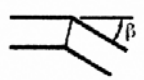

For more information on chlorination, please refer to document 'pre-commissioning of systems' available at www.conexbanninger.com.

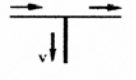
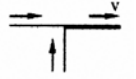
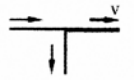
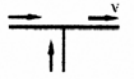
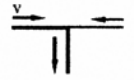
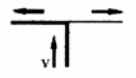
Note: Commercial anti-corrosion chemicals must not to be used on potable water systems.

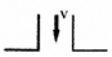

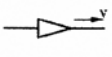
1.8 Loss Coefficients

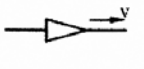
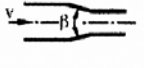
Table 4

Symbol	Designation	ζ	Application		Symbol	Designation	ζ	Application	
			DW	H				DW	H
	Angle or elbow reference value in accordance with DIN 1988 T3	0,70	X	X		Distributor outlet	0,5	X	X
	Angle 90° r/d (r/d = 1,2 with fittings complying with DIN EN 1254)	= 0,5 = 1,0 = 2,0 = 3,0	1,0 0,35 0,20 0,15	X X X X	X X X X				
	Angle β	= 90° = 60° = 45°	1,3 0,8 0,4	X X X	X X X				
	Crossover	0,5	X	X					
	Branch, square flow separation	1,3	X	X					
	Flow merging	0,9	X	X					
	Clearance at flow merging	0,3	X	X					
	Clearance at flow merging	0,6	X	X					
	Counter-flow at flow merging	3,0	X	X					
	Counter-flow at flow separation	1,5	X	X					
						Reservoir outlet	0,5	X	
						Collective inlet	1,0	X	X
						Inlet	1,0	X	X
						Reducer	0,4	X	X
						Constriction β - constant =	30° 0,02 45° 0,04 60° 0,07	X X X	X X X
						Expansion β - constant =	10° 0,10 20° 0,15 30° 0,20 40° 0,20	X X X X	X X X X
						Expansion bends	1,0	X	X
						Compensator	2,0	X	X
						Compensator	2,0	X	X

Symbol	Designation	ζ	Application		Symbol	Designation	ζ	Application	
			DW	H				DW	H
	Branch, curved flow separation	0,9	X	X					
	Flow merging	0,4	X	X					
	Clearance at flow separation	0,3	X	X					
	Clearance at flow merging	0,2	X	X					
	Angle valves DN 10 DN 15 DN 20 to DN 50 DN 65 to DN 100	7,0 4,0 2,0 3,5 4,0	X X X X X	X X X X X					
	Diaphragm valves DN 15 DN 20 DN 25 to DN 32 DN 40 to DN 100	10,0 8,5 7,0 6,0 5,0	X X X X X	X X X X X					
	Shutter valves Piston valves Ball valves DN 10 to DN 15 DN 20 to DN 25 DN 32 to DN 150	1,0 0,5 0,3	X X X	X X X					
	Radiator valves	4,0		X					
	Control valve	2,0		X					
	Pressure regulator fully open	30,0		X					
	Shut-off valve Straight seat valve DN15 DN20 DN25 DN32 DN40 to DN100	10,0 8,5 7,0 6,0 5,0	X X X X X	X X X X X					
	Angle seat valve DN 15 DN20 DN 25 to DN50 DN65	3,5 2,5 2,0 0,7	X X X X	X X X X					
	Return flow inhibitor DN 15 to DN 20 DN 25 to DN 40 DN 50 DN 65 to DN 100	7,7 4,3 3,8 2,5	X X X X	X X X X					
	Control valve with return flow inhibitor DN 20 DN 25 to DN 50	6,0 5,0	X X	X X					
	Valve tapping sleeve DN 25 to DN 80	5,0	X						
	Boiler	2,5		X					
	Heating radiator	2,5		X					
	Panel radiator	3,0		X					

1.9 Product Guarantee

When professionally installed, used and maintained in accordance with the installation and maintenance instructions detailed in the >B< Press technical manual available on the Conex Bänninger website www.conexbanninger.com.

Conex Universal Ltd. guarantees that >B< Press supplied by Conex Universal Ltd. will be free of material defects resulting from errors in manufacture, for twenty five (25) years from the date of first purchase by an end user. This Guarantee is limited to the repair or replacement of defective product(s) (at the sole discretion of Conex Universal Ltd.). At the request of Conex Universal Ltd. the allegedly defective product(s) must be returned to the address below* and Conex Universal Ltd. reserves the right to inspect and test the alleged defects. This guarantee provided by Conex Universal Ltd. does not affect your statutory rights.

The Guarantee set out above is given by Conex Universal Ltd. and subject to the following conditions:

- A. Any alleged defects must be reported to Conex Universal Ltd. within one month of the first occurrence of any such alleged defect, clearly setting out the nature of the claim and the circumstances surrounding it.
- B. Conex Universal Ltd. shall be under no liability in respect of any defect in any product arising from:
- defective installation,
 - fair wear and tear,
 - wilful damage,
 - negligence of any party other than Conex Universal Ltd.,
 - abnormal working or environmental conditions,
 - failure to follow the instructions of Conex Universal Ltd.,
 - misuse (which includes any use of the product(s) concerned for a purpose or in a situation / environment or for an application other than that for which it was designed), or
 - alteration or repair of any product without the prior approval of Conex Universal Ltd.

- C. At the request of Conex Universal Ltd. the person claiming under this guarantee must deliver to Conex Universal Ltd. written evidence of the date of first purchase by an end user of the product(s) concerned.

*** The address for returns is:**

Customer Services at Conex Universal Limited.
Global House, 95 Vantage Point, The Pensnett Estate,
Kingswinford, West Midlands, DY6 7FT,
UNITED KINGDOM



>B< Press



>B< Press Technical Brochure

2.1 >B< Press Fittings

>B< Press fittings are quick and easy to install and are available in copper and copper alloy. This flame-free fitting is designed with an innovative 3-point press system to ensure a leak-free, secure, permanent joint and is suitable for multiple applications.

2.2 Fitting Construction

The >B< Press design has the advantage of a 3-point press profile; comprising of two mechanical presses on either side of the bead, and one press on the O-ring bead. The EPDM O-ring compresses to form a permanent leak-proof joint.

>B< Press copper fittings have a 'unpressed joint indicator' that highlights unpressed connections at test pressures of 0.1 to 6.0 bar. Any unpressed joints can easily be identified during the test phase and pressed, saving valuable time and money. There is no need to drain down as the pressing operation can be carried out while the water is still in the system.

>B< Press fittings are installed using a press tool with a compatible press jaw. Jaws are sized to match the fitting required. When force is exerted through the press tool the jaw closes to make a permanent joint.

Please refer to the approved list of press machines and jaws in section 2.3.



2.3 Compatible Press Tools

2.3.1 Tool chart

Table 5

12 to 35 mm Compact machines			
Manufacturer	Press machine	Press jaws	Jaw profile
Rothenberger	Romax Compact	Rothenberger - Compact	SV / B
	Romax Compact TT	Rothenberger - Compact	SV / B
Rems	Mini Press ACC	Rems - Mini	V / B
Klauke	MAP1/MAP2L/MAP215	Klauke - SBM	KSP4 / B
	MAP219/MAP2L19	Klauke - SBMX	KSP4 / B
Novopress	ACO102/ACO103	NovoPress - V-PB1	V / B
Milwaukee	M12	Milwaukee - J12	V / B
Hilti	NPR 019 IE-A22	Hilti - NPR PM V	V/B
Ridgid	RP 200/210/240/241	Ridgid - Compact Series	V / B
	RP215 15-28mm	Ridgid - Compact Series	V / B
Conel	PM 1	Conel - V-PB1	V / B
Viega	Picco	Viega Picco	PT2 / B

Table 6

12 to 54 mm Standard 32 kN machines			
Manufacturer	Press machine	Press jaws	Jaw profile
Rothenberger	Romax 3000/4000	Rothenberger - Standard*	SV / B
Rems	Power-Press/ Akku-Press	Rems - Standard*	V / B
Novopress	ECO/ACO202/203	Novopress - V-PB2*	V** / B
Conel	PM 2	Conel - V-PB2*	V / B
Klauke	UAP2/UAP3L/UAP332	Klauke - Standard SB*	KSP4 / B
Ridgid	RP 320/330/340	Ridgid - Standard Series*	V / B
Hilti	NPR 032 IE-A22	Hilti - NPR PS V*	V / B
Milwaukee	M18	Milwaukee - J18*	V** / B
Viega	Pressgun 5/6	Viega Standard*	PT2 / B

* Press Jaw only - not press slings, collars, chains or rings. ** Novopress & Milwaukee jaws with the  marking only
For inter tool compatibility please refer back to the manufacturer.

Compatible tool and jaws for >B< Press fittings being pressed with M profile jaws

Table 7

15 to 28 mm				
Manufacturer	Press Machine	Press Jaws	Jaw Profile	
REMS	Mini Press	REMS – Mini*	B	Approved
			M	Compatible
	Power Press/ Akku Press	REMS – Standard*	B	Approved
			M	Compatible
Rothenberger	Compact/ Compact TT	Rothenberger Mini*	SV	Approved
			M	Compatible
	Romax 3000/4000	Rothenberger Standard*	SV	Approved
			M	Compatible
NovoPress	ACO102/ ACO103	Novopress Compact PB1*	B	Approved
			M	Compatible
	ECO/ACO202 ECO/ACO203	Novopress Standard PB2*	B	Approved
			M	Compatible

*Press Jaws only, slings are not permitted.

Press Ring

Table 8

12 to 35mm machines			
Manufacturer	Press machine	Press ring	Ring profile
Rothenberger	Romax Compact	Press ring	SV/B
	Romax Compact TT		
	Romax 3000/4000		
Rems	Mini Press ACC	Press Ring	B/V
	Power-Press/AKU-Press		
Novopress	ACO102/ACO103	Pivoting Rings	B/V

2.4 Installation Requirements

2.4.1 Space required for the pressing process

The following minimum clearances are required from structural components to allow operation of tool for press fitting.

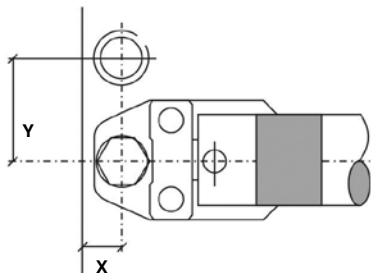

Table 9

Space required for the pressing process between fittings		
External tube	X	Y
Size mm	mm	mm
12	26	51
15	26	53
18	26	54
22	26	54
28	33	69
35	33	73
42	75	115
54	85	120

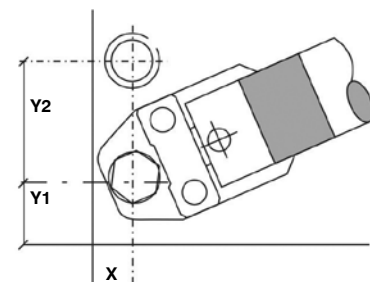

Table 10

Space required for the pressing process between fittings			
External tube	X	Y1	Y2
Size mm	mm	mm	mm
12	31	45	71
15	31	45	73
18	31	45	74
22	31	45	76
28	38	55	80
35	38	55	85
42	75	75	115
54	85	85	140

2.4.2 Insertion depth and minimum distance between pressings

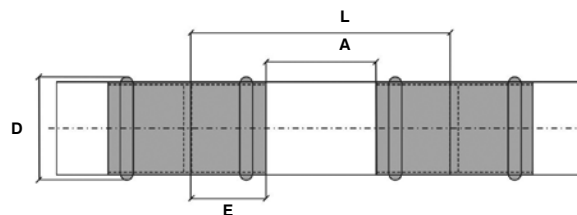

Table 11

Insertion depth and minimum distance between pressings				
Size	External - Ø pressing bead	Minimum distance	Minimum tube length	Insertion depth
mm	D - mm	A - mm	L - mm	E - mm
12	19	0	36	18
15	22.6	0	44	22
18	25.6	0	44	22
22	31	0	46	23
28	37	0	48	24
35	44	0	52	26
42	53.4	0	72	36
54	65.4	0	80	40

2.4.3 Minimum distance for press fittings from an existing brazed joint

To ensure proper sealing of both the brazed and pressed joints, the following minimum distances must be maintained between the joints. Please see Table 10 for further information.

Table 12

Minimum distance from a brazed joint	
Tube size	mm
12	5
15	5
18	5
22	5
28	5
35	10
42	15
54	20

2.4.4 Minimum brazing distance to an existing pressed fitting

Caution: Brazing or soldering near to >B< Press joints should be avoided as this may cause the seal to degrade due to heat transfer. Table 11 states the minimum distance away from the press joint which is acceptable to braze. If this distance cannot be maintained then adequate precautions must be taken such as fabricating the brazed section prior to assembly with the press fittings, wrapping in a wet rag or applying a hot block, to prevent heat transfer to the press fitting during brazing.

Table 13

Minimum distance brazing	
Tube size	mm
12	350
14	400
15	450
16	450
18	500
22	600
28	700
35	900
42	1200
54	1500

2.4.5 >B< Press tube compatibility table

>B< Press fittings can be used on hard, half-hard and soft copper tube to EN 1057 with the wall thicknesses stated below.

Table 14

Tube O/D	Tube wall thickness (mm)					
	Copper - R220		Copper - R250		Copper - R290	
12	0.6	–	0.8	1.0	1.0	–
14	1.0	–	1.0	1.0	1.0	–
15	1.0	–	0.7	1.0	1.0	–
16	1.0	–	1.0	1.0	1.0	–
18	1.0	–	0.8	1.0	1.0	–
22	1.0	1.2	0.9	1.1	1.0	1.5
28	–	–	0.9	1.2	1.0	1.5
35	–	–	1.2	–	1.0	1.5
42	–	–	1.2	–	1.0	1.5
54	–	–	1.2	–	1.2	2.0

>B< Press red brass fittings can also be used to connect stainless steel tube in accordance with EN 10312 parts 1 and 2. For more information please contact the technical department on technical@ibpgroup.com.

Compatible tubes for >B< Press fittings being pressed with M profile jaws

Table 15

Size (mm)	Tube Wall Thickness (mm)					
	Copper R220		Copper R250		Copper R290	
15	1.0	-	0.7	1.0	1.0	-
22	1.0	1.2	0.9	1.1	1.0	1.5
28	-	-	-	1.2	-	1.5

2.5 >B< Press Installation Process

Leave the fittings in the packaging prior to final installation to protect them from contamination and to preserve the lubrication of the O-rings. Please note the space required for pressing tools (see section 2.4.1).



1. Cut tube to length

- Use a rotary tube cutter.
- Ensure that the tube is cut square.
- Check the tube has retained its shape and is damage free.



2. Deburr

- Deburr the tube both internally and externally.
- Where possible angle the tube downwards to prevent filings entering the tube.
- Make sure the internal and external surfaces of the tube ends are smooth and free from burrs or sharp edges.

Caution: Please ensure that the tube surface is free from any deep scores or scratches.



3. Clean the tube

- Thoroughly clean the tube end using a rovlie or similar cleaning pad in a rotating action.
- Tube ends must be free from scratches, oxidation, dirt and debris.



4. Check for scratches and scores

- If deep scratches are still visible, cut the tube back to a clean section and prepare the tube end again.



5. Check the fittings

- Check the fitting is the correct size for the tube.
- Check the O-rings are present and correctly seated.
- Additional >B< Press lubricant (silicon oil) may be used to aid tube insertion. (MPABPSOIL100ML)



6. Assemble and mark the insertion depth

- The tube must be fully inserted into the fitting until it reaches the tube stop.
- To reduce the risk of dislodging the O-ring, rotate the tube (if possible) while slipping it into the fitting.
- Mark the insertion depth on the tube.
- Prior to pressing ensure the tube has not moved out from the fitting socket.



7. Complete the joint with the press tool

- Ensure pipework is correctly aligned prior to pressing.
- Ensure the correct size jaw is inserted into the tool.
- The jaws must be placed squarely on the fitting, locating the groove on the bead.
- The bead on the fitting should fit centrally in the groove of the jaw.
- Depress and hold the start button on the press tool to complete the pressing cycle.
- Pressing is complete when the jaws are fully closed.
- Complete the press cycle once only – do not re-press.



8. Mark the completed joint

- Mark the completed joint after pressing.
- This enables joints to be inspected easily before testing.

2.6 The Range

P4001G 90° Bend with Male Thread 	P4090G 90° Elbow with Female Thread 	P4093G Wall Plate Elbow Tank Connector 	P4096G Female Bent Union 	P4130G Tee with Female Threaded Branch 
P4132G Male branch Tee (ISO 7) 	P4243G Male Straight Connector 	P4244G Straight Tank Connector 	P4270G Female Straight Connector 	P4275 Slip Coupler Long 
P4280G Male Adaptor 	P4281G Female Adaptor 	P4330 Union 	P4330G Female Straight Union Connector 	P4331G Male Straight Union Connector 
P4355 Flat Face Connector 	P4471G Wall Plate Elbow 	P5001 90° Street Bend 	P5002 90° Bend 	P5002L 90° Bend Long 
P5040 45° Obtuse Street Elbow 	P5041 45° Obtuse Elbow 	P5060 Return Bend 	P5085 Crossover Coupler 	P5086 45° Crossover Street Coupler 
P5130 Tee - Equal 	P5130RB Tee - Reduced Branch 	P5130REB Tee - Reduced End & Branch 	P5130RE Tee - Reduced End 	P5130RBE Tee - Reduced Both Ends 
P5240 Reduced Straight Coupler 	P5243 Fitting Reducer 	P5270 Straight Coupler 	P5270S Slip Coupler 	P5290 Male Stop End 
P5301 Stop End 	MPABPSOIL100ML Fitting Lubricant 			

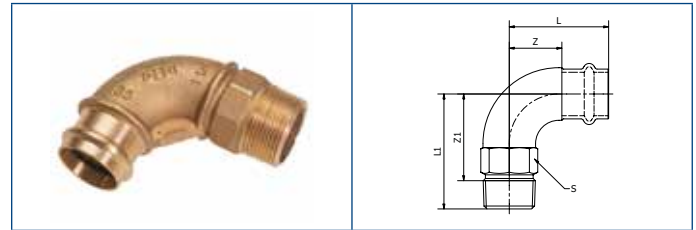

P4001G (ISO 7-1)
90° Bend with Male Thread

Code	Fitting size	L	L1	Z	Z1	S
P4001G01203000	12 x 3/8"	38	40	20	29.9	15
P4001G01204000	12 x 1/2"	37	44	19	31	17
P4001G01503000	15 x 3/8"	46	48	22	37.9	17
P4001G01504000	15 x 1/2"	45	48	21	34.8	20.5
P4001G01804000	18 x 1/2"	46	50	22	36.8	20.5
P4001G01806000	18 x 3/4"	47	56	23	41.5	27
P4001G02206000	22 x 3/4"	51	59	27	44.5	27
P4001G02808000	28 x 1"	58	72	34	55.2	36
P4001G03510000	35 x 1 1/4"	73	89	47	70	44
P4001G04212000	42 x 1 1/2"	93	97	52	78	52
P4001G05416000	54 x 2"	110	130	64	106.5	60

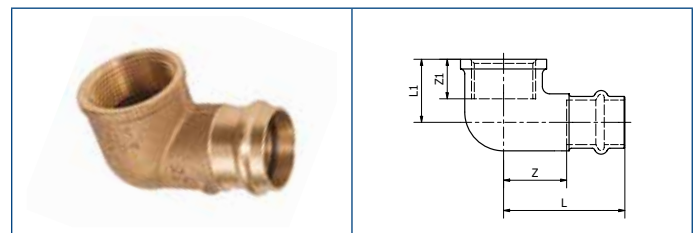

P4090G (ISO 7-1)
90° Elbow with Female Thread

Code	Fitting size	L	L1	Z	Z1
P4090G01203000	12 x 3/8"	39	19.5	21	11.4
P4090G01204000	12 x 1/2"	40	22.5	22	15
P4090G01503000	15 x 3/8"	46	19	22	11.4
P4090G01504000	15 x 1/2"	46	21	22	13.5
P4090G01506000	15 x 3/4"	50	26	26	16.3
P4090G01804000	18 x 1/2"	45	23.5	21	15
P4090G01806000	18 x 3/4"	50	26	26	16.3
P4090G02204000	22 x 1/2"	51	26	27	15
P4090G02206000	22 x 3/4"	52	27	28	16.3
P4090G02208000	22 x 1"	59	30	35	19.1
P4090G02808000	28 x 1"	59	34	35	19.1
P4090G03510000	35 x 1 1/4"	66	40	40	21.4
P4090G04212000	42 x 1 1/2"	77	44	36	21.4
P4090G05416000	54 x 2"	98	55	52	25.7

*All above measurements are in mm unless stated differently.

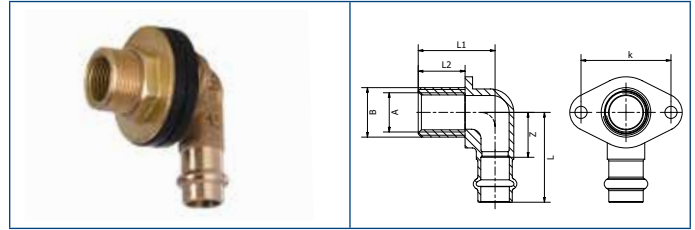

**P4093G (ISO 228)
Wallplate Elbow Tank Connector**

Code	Fitting size	A	B	L	L1	L2	Z	k
P4093G01504025	15 x 1/2 x 3/4 x 25	1/2"	3/4"	48	41	25	24	48
P4093G01504035	15 x 1/2 x 3/4 x 35	1/2"	3/4"	48	51	35	24	48



**P4096G (ISO 228)
Female Bent Union**

Code	Fitting size	L	L1	Z	Z1	S	S1
P4096G01204000	12 x 1/2"	57	33	39	18	29	27
P4096G01504000	15 x 1/2"	63.5	33	39.5	18	29	27
P4096G01804000	18 x 1/2"	64	33	40	18	29	27
P4096G01806000	18 x 3/4"	68	37	44	20.5	36.5	33
P4096G02206000	22 x 3/4"	74.5	37	50.5	20.5	36.5	33
P4096G02208000	22 x 1"	76.5	45	52.5	26	36.5	40
P4096G02808000	28 x 1"	82.5	47	58.5	28	45.5	40
P4096G03510000	35 x 1 1/4"	85.5	55	59.5	33.5	52	50.5
P4096G04212000	42 x 1 1/2"	100.5	59	59.5	37.5	58.5	55
P4096G05416000	54 x 2"	124.5	68	78.5	42.5	75	69

*All above measurements are in mm unless stated differently.

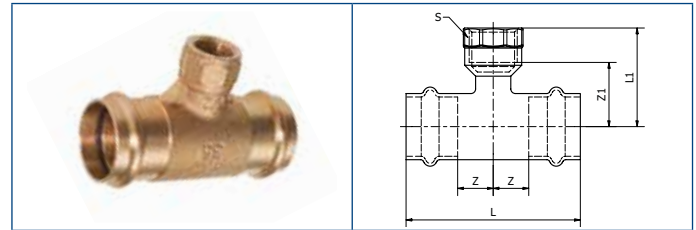

P4130G (ISO 7-1)**

Tee with Female Threaded Branch

Code	Fitting size	L	L1	Z	Z1	S
P4130G01204012	12 x 1/2" x 12	80	35	22	20	26
P4130G01503015	15 x 3/8" x 15	85	35	18.5	23.6	21
P4130G01504015	15 x 1/2" x 15	80	20	16	38	24
P4130G01804018	18 x 1/2" x 18	90	40	21	25	26
P4130G02204022	22 x 1/2" x 22	84	29	18	14	26
P4130G02206022	22 x 3/4" x 22	97	45	24.5	28.7	32
P4130G02804028	28 x 1/2" x 28	89	32	18.5	17	26
P4130G02806028	28 x 3/4" x 28	105	50	28.5	33.7	32
P4130G03504035	35 x 1/2" x 35	100	48	24	33	26
P4130G04204042	42 x 1/2" x 42	110	50	14	35	26
P4130G05404054	54 x 1/2" x 54	132	55	25	40	26

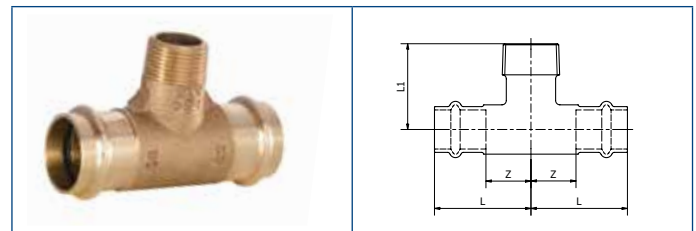

P4132G (ISO 7-1)**

Male Branch Tee

Code	Fitting size	L	L1	Z
P4132G01504015	15 x 1/2" x 15	90	40	21
P4132G01806018	18 x 3/4" x 18	90	40	21
P4132G02206022	22 x 3/4" x 22	97	50	24.5
P4132G02806028	28 x 3/4" x 28	100	45	26
P4132G03506035	35 x 3/4" x 35	100	50	24
P4132G04206042	42 x 3/4" x 42	110	50	14
P4132G05408054	54 x 1" x 54	138	64	23
P4132G05410054	54 x 1 1/4" x 54	144	66	26

*All above measurements are in mm unless stated differently. ** Product description reads end, branch, end.

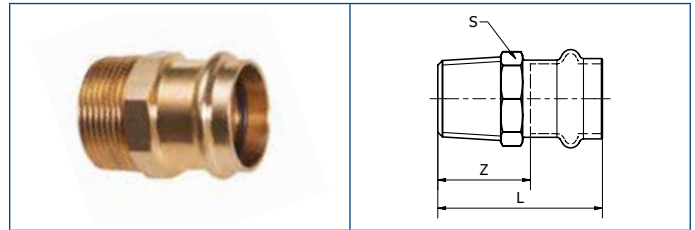

**P4243G (ISO 7-1)
Male Straight Connector**

Code	Fitting size	L	Z	S
P4243G01203000	12 x 3/8"	35	17	17
P4243G01204000	12 x 1/2"	39	21	22
P4243G01403000	14 x 3/8"	39	16	19
P4243G01404000	14 x 1/2"	43	20	22
P4243G01406000	14 x 3/4"	50	27	28
P4243G01503000	15 x 3/8"	39	17	19
P4243G01504000	15 x 1/2"	43.5	19.5	22
P4243G01506000	15 x 3/4"	48.5	24.5	28
P4243G01604000	16 x 1/2"	43	20	22
P4243G01606000	16 x 3/4"	50	27	28
P4243G01804000	18 x 1/2"	43	19	22
P4243G01806000	18 x 3/4"	46.5	22.5	27
P4243G02204000	22 x 1/2"	46	22	27
P4243G02206000	22 x 3/4"	47	23	27
P4243G02208000	22 x 1"	52	28	34
P4243G02806000	28 x 3/4"	52	28	33
P4243G02808000	28 x 1"	53	29	34
P4243G02810000	28 x 1 1/4"	62	38	42
P4243G03508000	35 x 1"	52	26	40
P4243G03510000	35 x 1 1/4"	57	31	43
P4243G03512000	35 x 1 1/2"	61	35	50
P4243G04210000	42 x 1 1/4"	65	24	48
P4243G04212000	42 x 1 1/2"	62.5	29.5	50
P4243G05412000	54 x 1 1/2"	74.5	28.5	62
P4243G05416000	54 x 2"	77	31	62

22

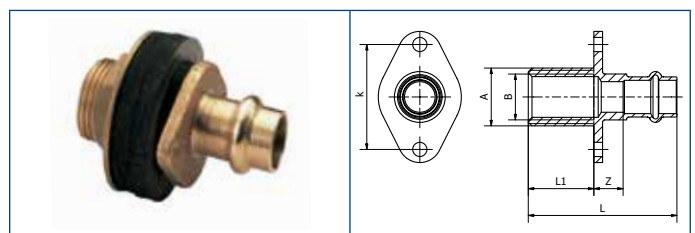

**P4244G (ISO 228)
Straight Tank Connector**

Code	Fitting size	A	B	L	L1	Z	k
P4244G01504030	15 x 1/2 x 3/4 x 30	1/2"	3/4"	68	30	14	48

*All above measurements are in mm unless stated differently.

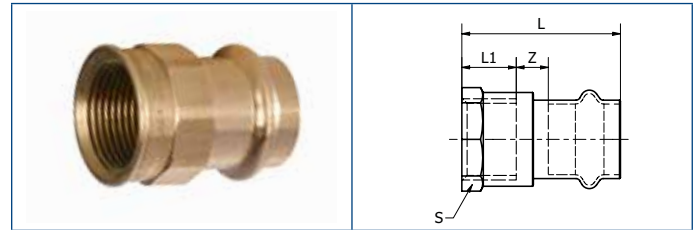

**P4270G (ISO 7-1)
Female Straight Connector**

Code	Fitting size	L	min L1	Z	S
P4270G01203000	12 x 3/8"	32	11.4	2.6	20.5
P4270G01204000	12 x 1/2"	39	15	2	26
P4270G01403000	14 x 3/8"	37	11.4	2.6	20.5
P4270G01404000	14 x 1/2"	44	15	6	26
P4270G01406000	14 x 3/4"	45	16.3	5.7	30.5
P4270G01503000	15 x 3/8"	37.5	11.4	2.1	20.5
P4270G01504000	15 x 1/2"	41	15	2	26
P4270G01506000	15 x 3/4"	45	16.3	4.7	30.5
P4270G01606000	16 x 3/4"	44	16.3	4.7	30.5
P4270G01804000	18 x 1/2"	41	15	2	26
P4270G01806000	18 x 3/4"	45	16.3	4.7	30.5
P4270G02204000	22 x 1/2"	44	15	5	26
P4270G02206000	22 x 3/4"	45.5	16.3	5.2	30.5
P4270G02208000	22 x 1"	48	19.1	4.9	37.5
P4270G02806000	28 x 3/4"	47	16.3	6.7	33
P4270G02808000	28 x 1"	50.5	19.1	7.4	37.5
P4270G02810000	28 x 1 1/4"	56.5	21.4	11.1	47
P4270G03508000	35 x 1"	48	19.1	2.9	40
P4270G03510000	35 x 1 1/4"	54	21.4	6.6	47
P4270G04210000	42 x 1 1/4"	65	21.4	2.6	47
P4270G04212000	42 x 1 1/2"	68	21.4	5.6	55
P4270G05416000	54 x 2"	74	25.7	2.3	70

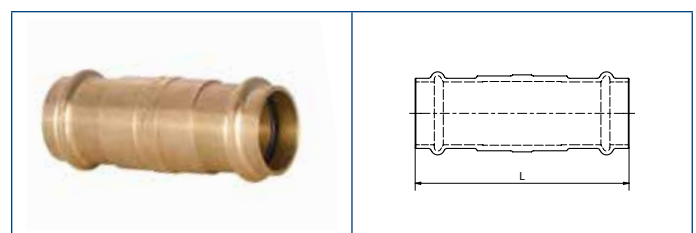

**P4275
Slip Coupler Long**

Code	Fitting size	L
P4275 01200000	12	64
P4275 01400000	14	80
P4275 01500000	15	80
P4275 01600000	16	80
P4275 01800000	18	80
P4275 02200000	22	85
P4275 02800000	28	95
P4275 03500000	35	105
P4275 04200000	42	120
P4275 05400000	54	136

*All above measurements are in mm unless stated differently.

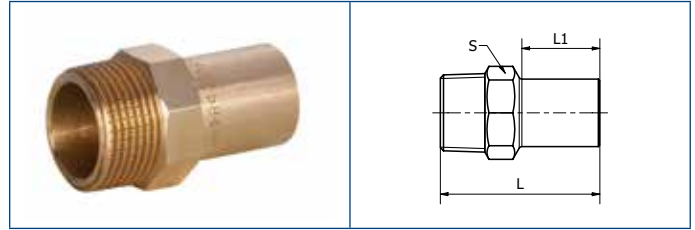

**P4280G (ISO 7-1)
Male Adaptor**

Code	Fitting size	L	min L1	S
P4280G01204000	12 x 1/2"	39	12.5	22
P4280G01504000	15 x 1/2"	49	16	22
P4280G01804000	18 x 1/2"	48	18	22
P4280G01806000	18 x 3/4"	46	18	21
P4280G02204000	22 x 1/2"	43	18.5	22
P4280G02206000	22 x 3/4"	52	20	28
P4280G02808000	28 x 1"	52	20.5	34
P4280G03510000	35 x 1 1/4"	59.5	20	43

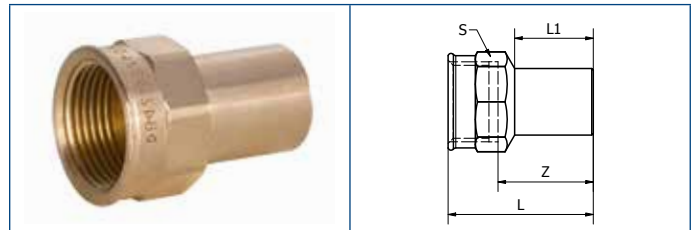

**P4281G (ISO 7-1)
Female Adaptor**

Code	Fitting size	L	L1	Z	S
P4281G01204000	12 x 1/2"	41	20	26	25
P4281G01504000	15 x 1/2"	48	26	33	26
P4281G01804000	18 x 1/2"	45.5	26	30.5	26
P4281G01806000	18 x 3/4"	49	26	33	30.5
P4281G02204000	22 x 1/2"	45	26	38	26
P4281G02206000	22 x 3/4"	48	26	31.5	30.5
P4281G02806000	28 x 3/4"	46	26	30	30.5
P4281G02808000	28 x 1"	51	26	32	37.5
P4281G03508000	35 x 1"	51	28	32	37.5
P4281G03510000	35 x 1 1/4"	55.5	28	34	50

*All above measurements are in mm unless stated differently.

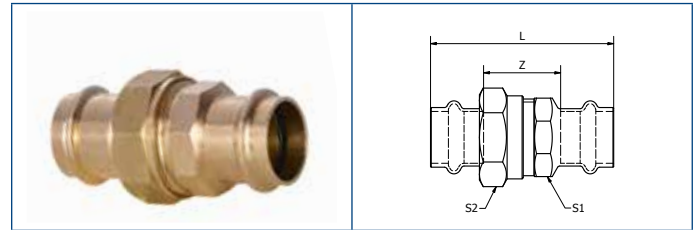

**P4330
Union**

Code	Fitting size	L	Z	S1	S2
P4330 01200000	12	65	29	25	31
P4330 01500000	15	78.5	29	25	30.5
P4330 01800000	18	78.5	29	25	30.5
P4330 02200000	22	89	36.5	31	41
P4330 02800000	28	96.5	45.5	39	48.5
P4330 03500000	35	99.5	52	45	45.5
P4330 04200000	42	119.5	58.5	50	37.5
P4330 05400000	54	143	75	70	51

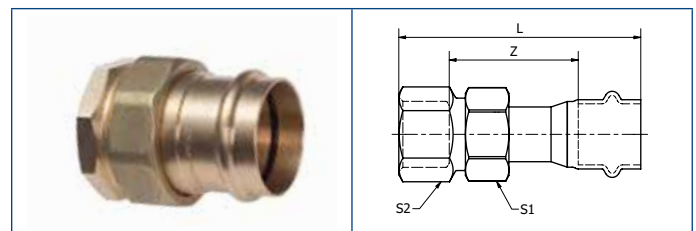

**P4330G (ISO 7-1)
Female Straight Union Connector**

Code	Fitting size	L	Z	S1	S2
P4330G01204000	12 x 1/2"	56.5	38.5	29	27
P4330G01504000	15 x 1/2"	63	39	29	27
P4330G01506000	15 x 3/4"	67.5	43.5	29	30.5
P4330G01804000	18 x 1/2"	61.5	37.5	29	27
P4330G01806000	18 x 3/4"	68	44	29	30.5
P4330G02206000	22 x 3/4"	71.5	47.5	36.5	36
P4330G02208000	22 x 1"	81	57	36.5	40
P4330G02808000	28 x 1"	77	53	45.5	42
P4330G03510000	35 x 1 1/4"	80.5	54.5	52	50
P4330G04212000	42 x 1 1/2"	89.5	48.5	58.5	55
P4330G05416000	54 x 2"	95	49	75	70

*All above measurements are in mm unless stated differently.

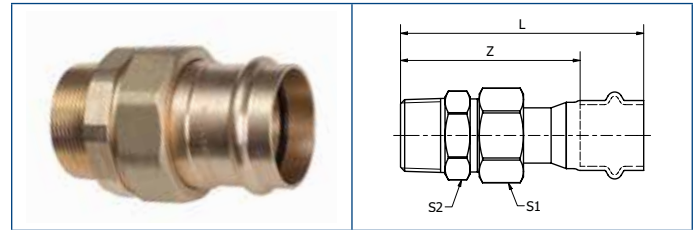

**P4331G (ISO 7-1)
Male Straight Union Connector**

Code	Fitting size	L	Z	S1	S2
P4331G01203000	12 x 3/8"	56	38	29	27
P4331G01204000	12 x 1/2"	59	41	29	27
P4331G01504000	15 x 1/2"	65.5	41.5	29	27
P4331G01506000	15 x 3/4"	69	45	29	27
P4331G01804000	18 x 1/2"	64	40	29	27
P4331G01806000	18 x 3/4"	69.5	45.5	29	27
P4331G02204000	22 x 1/2"	72.5	48.5	36.5	33
P4331G02206000	22 x 3/4"	74.	50	36.5	33.5
P4331G02208000	22 x 1"	77	53	36.5	33.5
P4331G02808000	28 x 1"	80	56	45.5	44
P4331G03510000	35 x 1 1/4"	85	59	52	50
P4331G04212000	42 x 1 1/2"	94.5	53.5	58.5	55
P4331G05416000	54 x 2"	117	71	75	72

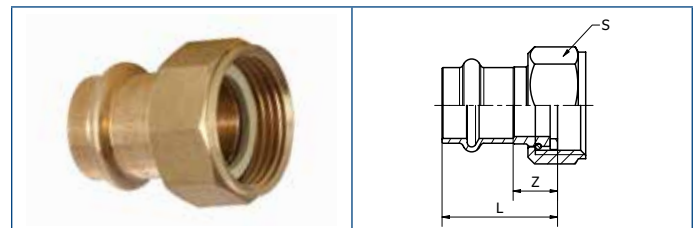

**P4355 (ISO 228)
Flat Face Connector**

Code	Fitting size	L	Z	S
P4355 01203000	12 x 3/8"	38	20	20
P4355 01204000	12 x 1/2"	38.5	20.5	24
P4355 01403000	14 x 3/8"	38.5	14.5	19
P4355 01404000	14 x 1/2"	41	16	24
P4355 01504000	15 x 1/2"	42	16	24
P4355 01506000	15 x 3/4"	34.5	10.5	29
P4355 01604000	16 x 1/2"	42	16.5	24
P4355 01606000	16 x 3/4"	34.5	11.5	29
P4355 01806000	18 x 3/4"	35	11	29
P4355 02206000	22 x 3/4"	52	28	29
P4355 02208000	22 x 1"	38.5	14.5	36.5
P4355 02810000	28 x 1 1/4"	42.5	18.5	45.5
P4355 03512000	35 x 1 1/2"	41.5	15.5	52
P4355 04214000	42 x 1 3/4"	48.5	41	58.5
P4355 05419000	54 x 2 3/8"	62	16.5	75

*All above measurements are in mm unless stated differently.

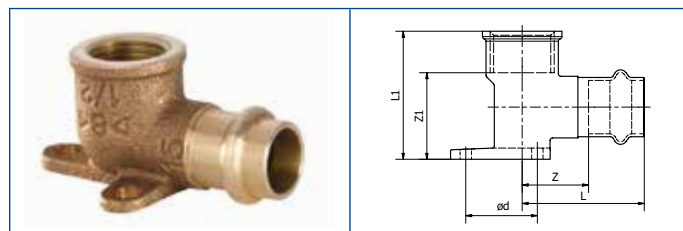

**P4471G (ISO 7-1)
Wall Plate Elbow**

Code	Fitting size	L	L1	Z	Z1	ød
P4471G01204000	12 x 1/2"	40	33	22	18	40
P4471G01504000	15 x 1/2"	46	32.5	22	21	40
P4471G01804000	18 x 1/2"	45	36.5	21	21.5	40
P4471G02206000	22 x 3/4	52	48	28	31.7	50

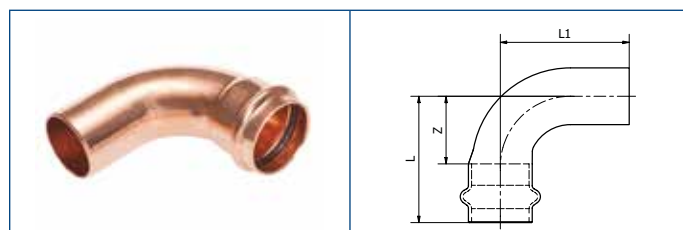

**P5001
90° Street Bend**

Code	Fitting size	L	L1	Z
P5001 01200000	12	33	35	15
P5001 01400000	14	37.5	39.5	15.5
P5001 01500000	15	38	44	16
P5001 01600000	16	40	42	18
P5001 01800000	18	40	46	18
P5001 02200000	22	42	52	19
P5001 02800000	28	55	60	31
P5001 03500000	35	59	70	41
P5001 04200000	42	87	89	51
P5001 05400000	54	105	107	65

*All above measurements are in mm unless stated differently.

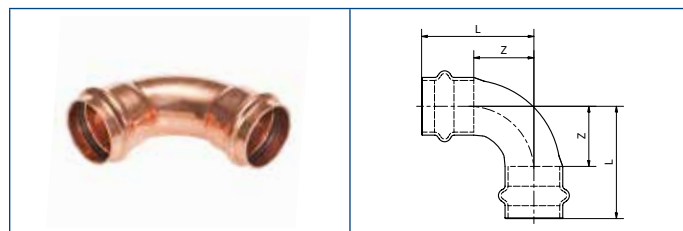

**P5002
90° Bend**

Code	Fitting size	L	Z
P5002 01200000	12	33	15
P5002 01400000	14	37.5	15.5
P5002 01500000	15	38	16
P5002 01600000	16	40	18
P5002 01800000	18	44	22
P5002 02200000	22	42	19
P5002 02800000	28	55	31
P5002 03500000	35	69	43
P5002 04200000	42	87	51
P5002 05400000	54	105	65

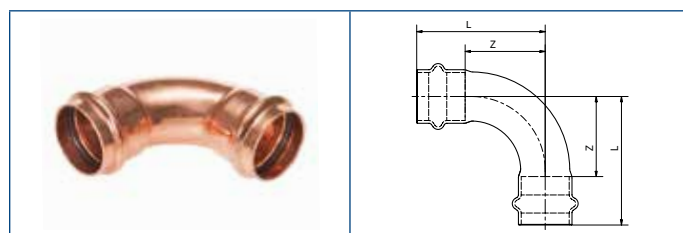

**P5002L
90° Bend Long**

Code	Fitting size	L	Z
P5002L01500000	15	40	18
P5002L01800000	18	44	22
P5002L02200000	22	50	27
P5002L02800000	28	58	34

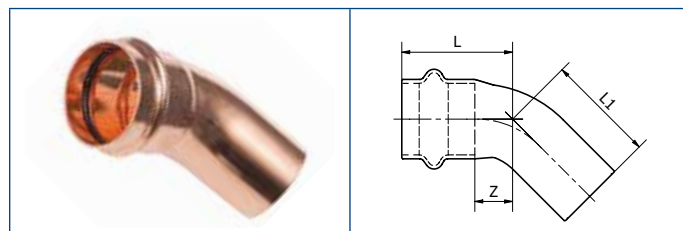

P5040
45° Obtuse Street Bend

Code	Fitting size	L	L1	Z
P5040 01200000	12	24	26	6
P5040 01400000	14	30	32	8
P5040 01500000	15	30	32	8
P5040 01600000	16	30	32	8
P5040 01800000	18	31	33	9
P5040 02200000	22	34	36	11
P5040 02800000	28	38	40	14
P5040 03500000	35	44	46	18
P5040 04200000	42	57	59	21
P5040 05400000	54	67	69	27

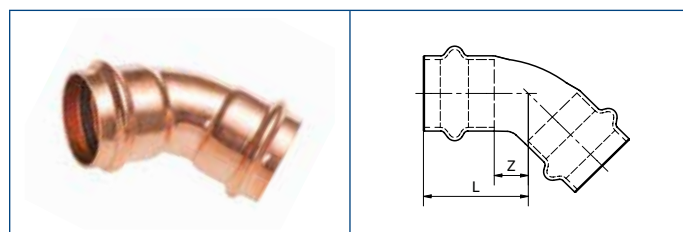

P5041
45° Obtuse Elbow

Code	Fitting size	L	Z
P5041 01200000	12	24	6
P5041 01400000	14	28	6
P5041 01500000	15	30	8
P5041 01600000	16	30	8
P5041 01800000	18	31	9
P5041 02200000	22	34	11
P5041 02800000	28	38	14
P5041 03500000	35	44	18
P5041 04200000	42	57	21
P5041 05400000	54	67	27

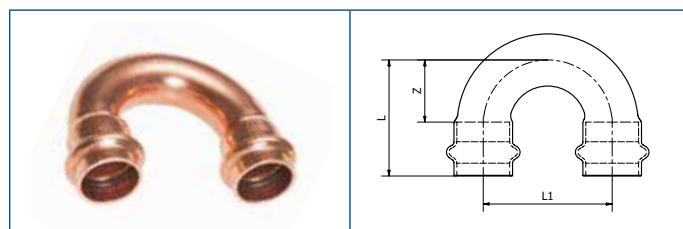

P5060
Return Bend

Code	Fitting size	L	L1	Z
P5060 02200000	22	58	60	35

*All above measurements are in mm unless stated differently.

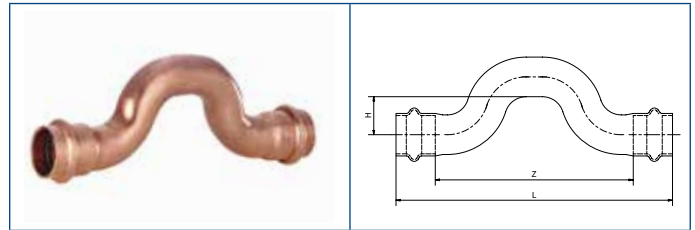

P5085
Crossover Coupler

Code	Fitting size	L	Z	H
P5085 01500000	15	134	90	28
P5085 01800000	18	144	100	29
P5085 02200000	22	162	116	54

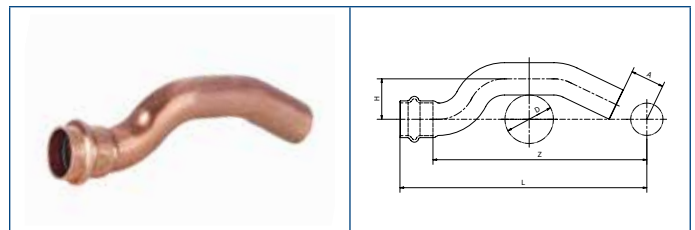

P5086
45° Crossover Street

Code	Fitting size	D	L	Z	H	A
P5086 01200000	12	24	126	108	18	24
P5086 01500000	15	25	139	117	20	18
P5086 02200000	22	27	145	123	22.5	22
P5086 02800000	28	33	168	145	27.5	23

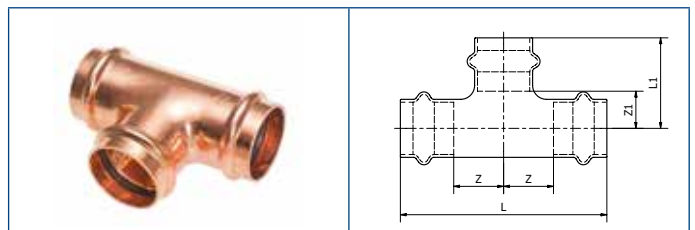

P5130
Tee - Equal

Code	Fitting size	L	L1	Z	Z1
P5130 01212012	12 x 12 x 12	72	28	18	10
P5130 01414014	14 x 14 x 14	78	33	17	11
P5130 01515015	15 x 15 x 15	82	33	19	11
P5130 01616016	16 x 16 x 16	80	34	18	12
P5130 01818018	18 x 18 x 18	84	38	17	13
P5130 02222022	22 x 22 x 22	90	37.5	20	13
P5130 02828028	28 x 28 x 28	96	43	24	19
P5130 03535035	35 x 35 x 35	98	48	26	22
P5130 04242042	42 x 42 x 42	130	65	29	29
P5130 05454054	54 x 54 x 54	150	75	35	35

*All above measurements are in mm unless stated differently.

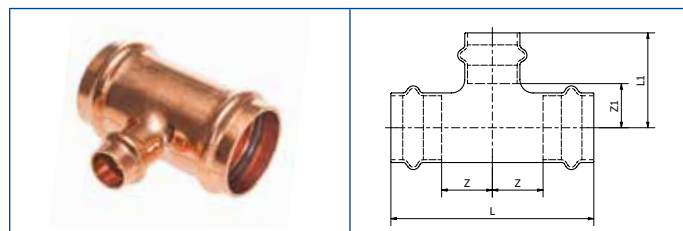

P5130RB**
Tee - Reduced Branch

Code	Fitting size	L	L1	Z	Z1
P5130 01412014	14 x 12 x 14	78	29	17	11
P5130 01512015	15 x 12 x 15	77.5	31	16.5	11
P5130 01612016	16 x 12 x 16	78	29	17	11
P5130 01614016	16 x 14 x 16	78	35	17	13
P5130 01812018	18 x 12 x 18	64	35.5	10	13
P5130 01814018	18 x 14 x 18	84	36	20	13
P5130 01815018	18 x 15 x 18	84	36	20	13
P5130 01816018	18 x 16 x 18	85	36	20.5	13
P5130 02212022	22 x 12 x 22	65	37.5	9.5	13
P5130 02214022	22 x 14 x 22	80	37	17	13
P5130 02215022	22 x 15 x 22	80	37	17	13
P5130 02216022	22 x 16 x 22	80	38	17	13
P5130 02218022	22 x 18 x 22	82	43	18	13
P5130 02815028	28 x 15 x 28	81	41	16.5	19
P5130 02818028	28 x 18 x 28	83	41	17.5	19
P5130 02822028	28 x 22 x 28	91	43	20	19
P5130 03515035	35 x 15 x 35	74	44	11	22
P5130 03518035	35 x 18 x 35	78.4	44.2	14	22
P5130 03522035	35 x 22 x 35	80	46	14	22
P5130 03528035	35 x 28 x 35	88.5	46	18	22
P5130 04222042	42 x 22 x 42	103	52	16.5	29
P5130 04228042	42 x 28 x 42	111	59	20.5	29
P5130 04235042	42 x 35 x 42	113.5	56	20.5	29
P5130 05422054	54 x 22 x 54	102	57	11	35
P5130 05428054	54 x 28 x 54	109	58	14.5	35
P5130 05435054	54 x 35 x 54	124	61	17.5	35
P5130 05442054	54 x 42 x 54	129	76	24.5	35

*All above measurements are in mm unless stated differently. ** Product description reads end, branch, end.

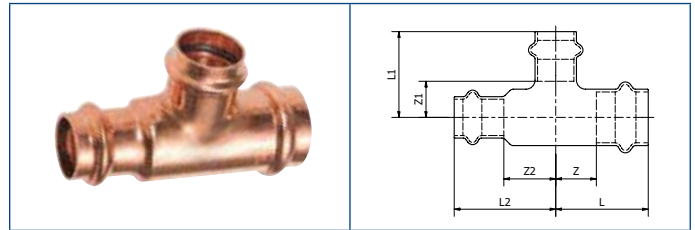

P5130REB**
Tee - Reduced End and Branch

Code	Fitting size	L	L1	L2	Z	Z1	Z2
P5130 01412012	14 x 12 x 12	31.5	29	31.5	9.5	11	13.5
P5130 01512012	15 x 12 x 12	32	31.5	34.5	10	11	16.5
P5130 01614014	16 x 14 x 14	41.5	35.5	42.5	19.5	13.5	20.5
P5130 01815015	18 x 15 x 15	41.5	35.5	42.5	19.5	13	20.5
P5130 02215015	22 x 15 x 15	40	35	43	17	13	21
P5130 02215018	22 x 15 x 18	34	37	38.5	11	15	16.5
P5130 02218015	22 x 18 x 15	36	37.5	42	13	15.5	20
P5130 02218018	22 x 18 x 18	40	37.5	41	17	13	19
P5130 02815022	28 x 15 x 22	35	41	40	11	19	18
P5130 02818022	28 x 18 x 22	37.5	41.5	42	13.5	19.5	19
P5130 02822022	28 x 22 x 22	40	41	44	16	19	21
P5130 03522028	35 x 22 x 28	41	44	46	15	22	22
P5130 03528028	35 x 28 x 28	44	45	52	18	22	28
P5130 04235035	42 x 35 x 35	58	55	56	22	29	30
P5130 05442042	54 x 42 x 42	67.5	71.5	74.5	27.5	35	38.5

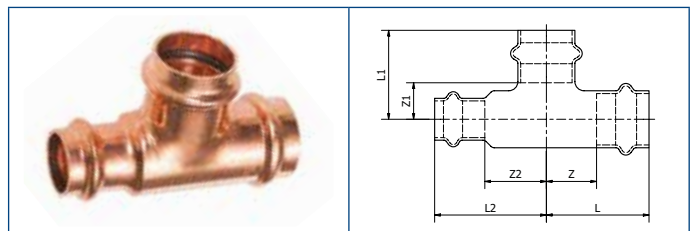

P5130RE**
Tee - Reduced End

Code	Fitting size	L	L1	L2	Z	Z1	Z2
P5130 01616014	16 x 16 x 14	41.5	33.8	42.5	19.5	11.8	20.5
P5130 01818015	18 x 18 x 15	41.5	36.5	42.5	19.5	13	20.5
P5130 02222015	22 x 22 x 15	43	37	46	20	13	24
P5130 02222018	22 x 22 x 18	45	38	45.5	22	15	23.5
P5130 02828015	28 x 28 x 15	41	41	49	17	19	27
P5130 02828018	28 x 28 x 18	43.5	43.5	49.5	19.5	19.5	27.5
P5130 02828022	28 x 28 x 22	43	43	48	19	19	25

*All above measurements are in mm unless stated differently. ** Product description reads end, branch, end.

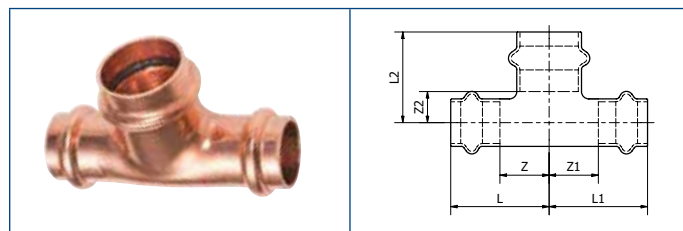

P5130RBE**
Tee - Reduced Both Ends

Code	Fitting size	L	L1	L2	Z	Z1	Z2
P5130 01215012	12 x 15 x 12	32	32	32	14	14	10
P5130 01416014	14 x 16 x 14	38	38	33	38	38	11
P5130 01518015	15 x 18 x 15	38	38	33	16	16	11
P5130 01522015	15 x 22 x 15	41	41	34	19	19	11
P5130 01822018	18 x 22 x 18	40	40	36	18	18	13
P5130 02228022	22 x 28 x 22	45.5	45.5	39	22.5	22.5	13

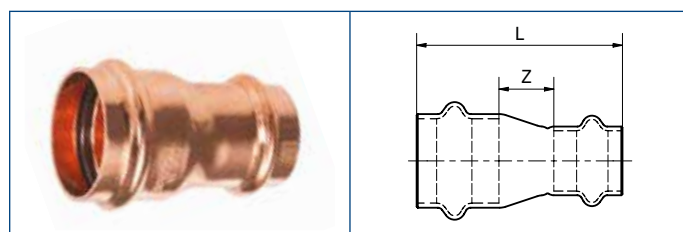

P5240
Reduced Straight Coupler

Code	Fitting size	L	Z
P5240 01412000	14 x 12	49	9
P5240 01512000	15 x 12	48	8
P5240 01614000	16 x 14	51	6
P5240 01814000	18 x 14	54.5	10.5
P5240 01815000	18 x 15	53	9
P5240 01816000	18 x 16	54.5	10.5
P5240 02214000	22 x 14	57.5	12.5
P5240 02215000	22 x 15	55	10
P5240 02216000	22 x 16	54	9.5
P5240 02218000	22 x 18	54.5	9
P5240 02822000	28 x 22	58	11
P5240 03528000	35 x 28	63	13
P5240 04235000	42 x 35	77	15
P5240 05442000	54 x 42	96	20

*All above measurements are in mm unless stated differently. ** Product description reads end, branch, end.

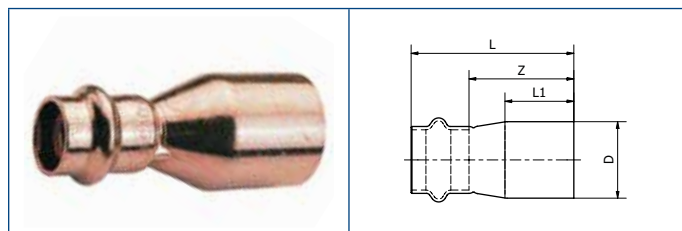

**P5243
Fitting Reducer**

Code	Fitting size	D	L	L1	Z
P5243 01412000	14 x 12	14	43.5	24	25.5
P5243 01512000	15 x 12	15	50	24	32
P5243 01612000	16 x 12	16	49	22	31
P5243 01614000	16 x 14	16	48.5	24	26
P5243 01812000	18 x 12	18	53	24	35
P5243 01814000	18 x 14	18	53	24	27
P5243 01815000	18 x 15	18	49	24	27
P5243 01816000	18 x 16	18	49	24	27
P5243 02214000	22 x 14	22	56	25	34
P5243 02215000	22 x 15	22	56	25	34
P5243 02216000	22 x 16	22	56	26	34
P5243 02218000	22 x 18	22	55	26	33
P5243 02815000	28 x 15	28	68	26	46
P5243 02816000	28 x 16	28	69	26	46
P5243 02818000	28 x 18	28	66	26	44
P5243 02822000	28 x 22	28	57	26	34
P5243 03522000	35 x 22	35	71	28	48
P5243 03528000	35 x 28	35	64	28	40
P5243 04222000	42 x 22	42	89	38	66
P5243 04228000	42 x 28	42	87	38	63
P5243 04235000	42 x 35	42	83	38	57
P5243 05435000	54 x 35	54	98	42	72
P5243 05442000	54 x 42	54	99	42	63

*All above measurements are in mm unless stated differently.

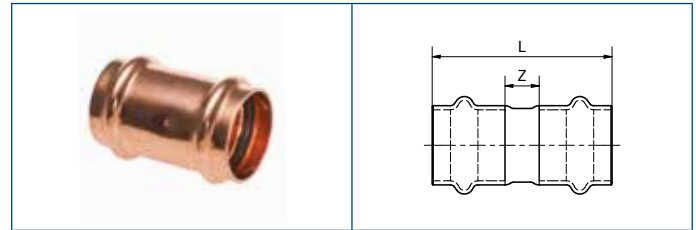

**P5270
Straight Coupler**

Code	Fitting size	L	Z
P5270 01200000	12	42	6
P5270 01400000	14	50	6
P5270 01500000	15	50	6
P5270 01600000	16	50	6
P5270 01800000	18	54	10
P5270 02200000	22	56	10
P5270 02800000	28	58	10
P5270 03500000	35	62	10
P5270 04200000	42	84	12
P5270 05400000	54	92	12

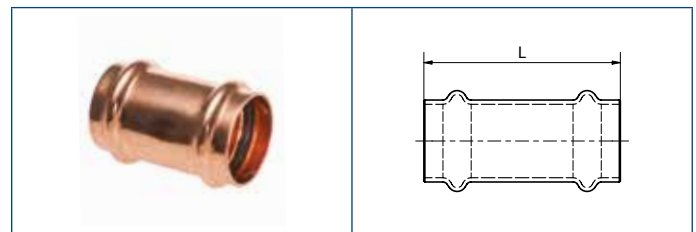

**P5270S
Slip Coupler**

Code	Fitting size	L
P5270S01200000	12	42
P5270S01500000	15	50
P5270S01600000	16	50
P5270S01800000	18	54
P5270S02200000	22	56
P5270S02800000	28	58
P5270S03500000	35	62
P5270S04200000	42	84
P5270S05400000	54	92

*All above measurements are in mm unless stated differently.

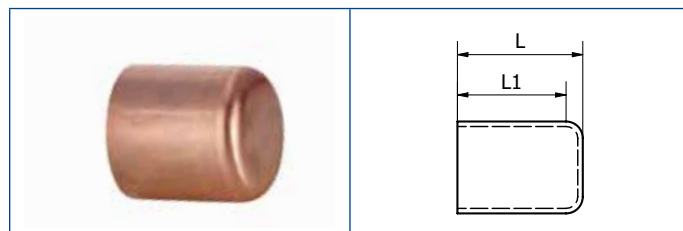

P5290 Male Stop End

Code	Fitting size	L	L1
P5290 01200000	12	25	21
P5290 01500000	15	29	25
P5290 01800000	18	29	25
P5290 02200000	22	30	26
P5290 02800000	28	31	27
P5290 03500000	35	34	29
P5290 04200000	42	45	40
P5290 05400000	54	49	43



P5301 Stop End

Code	Fitting size	L	L1
P5301 01200000	12	20.5	17.5
P5301 01400000	14	25	21.5
P5301 01500000	15	25	21.5
P5301 01600000	16	25	21.5
P5301 01800000	18	22	21.5
P5301 02200000	22	23.5	22.5
P5301 02800000	28	24	23.5
P5301 03500000	35	29	25
P5301 04200000	42	38.5	35
P5301 05400000	54	40.5	39



Fitting Lubricant for O-ring

Code	Size
MPABPSOIL100ML	100 ml

>B< Press XL



 >B< Press XL Technical Brochure
64 to 108 mm

3.1 >B< Press XL Copper Fittings

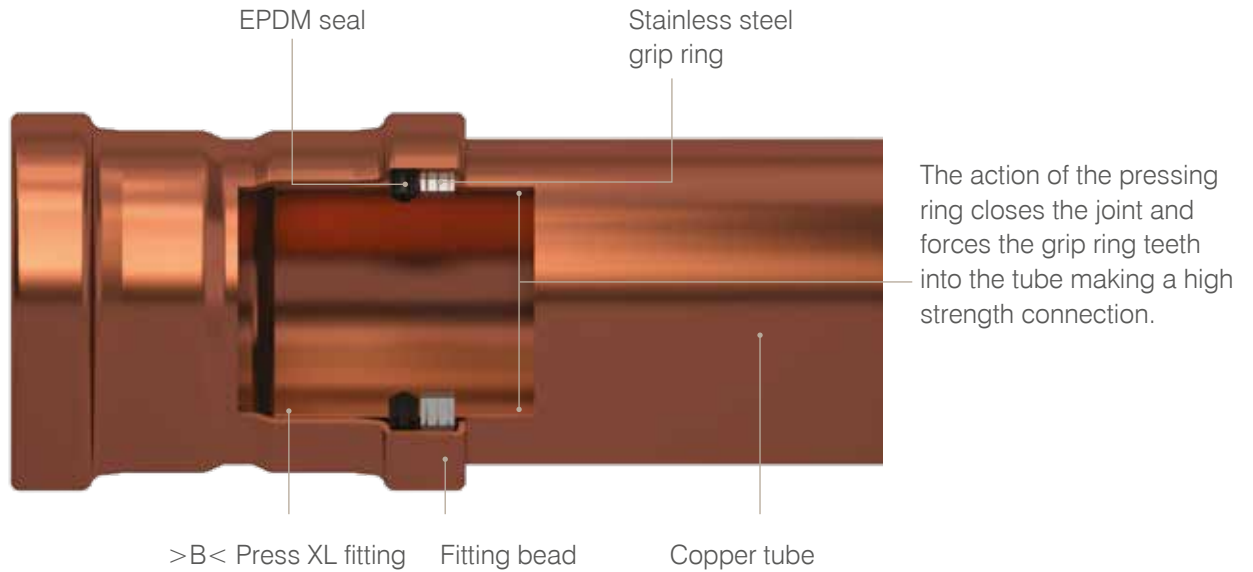

3.1.1 Product features

>B< Press XL has only two internal parts, the grip ring and the seal. Both parts have an internal diameter larger than the tube, which allows for easy tube insertion and pre-press leak indication.

3.1.2 Stainless steel grip ring

The full circumference grip ring ensures all round equal grip on the tube and an even seal compression between tube and fitting after pressing.



Stainless steel grip ring

3.1.3 Seal design

The triple point seal on the pressed fitting body counters any pressing distortion and gives greater seal contact area on the tube. The seal is self setting to ensure correct functioning. Seal security and longevity are increased as a result.



Fitting section

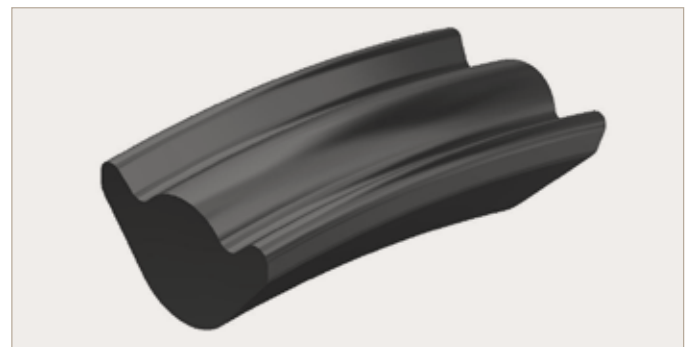

Triple point seal

3.2 Compatible Press Tools

3.2.1 Tool chart

Table 16

64 to 108 mm Standard Machines			
Manufacturer	Press machine	Press sling/ chain/ collar/ ring	Jaw profile
Rems	Power-Press / Akku-Press	Rems slings (including 66.7mm) + Z5 adaptor	VF
	Power Press XL ACC		
Novopress	ECO / ACO202 / 203	Novopress - Collars + ZB202 adaptor	V
	ACO202XL / 203XL		
Klauke	UAP2 / UAP3L / UAP332	Klauke - Chains QC + SBKQC adaptor	VXL
	UAP4 / UAP4L / UAP432		
Viega	Pressgun 5 / 6	Viega Press Chains + Z2 adaptor	PT2

For manufacturer cross compatibility please refer to the website - www.conexbanninger.com

3.3 Installation Requirements

3.3.1 Space required for the pressing process

The following minimum clearances from structural components are required to allow operation of tool for press fitting.

Table 17

Size (mm)	Minimum clearance required for the pressing process				
	A	B	C	D	E
64	100	145	100	100	165
66.7	100	145	100	100	165
76.1	100	145	100	100	165
88.9	115	165	115	120	185
108	125	185	125	130	210

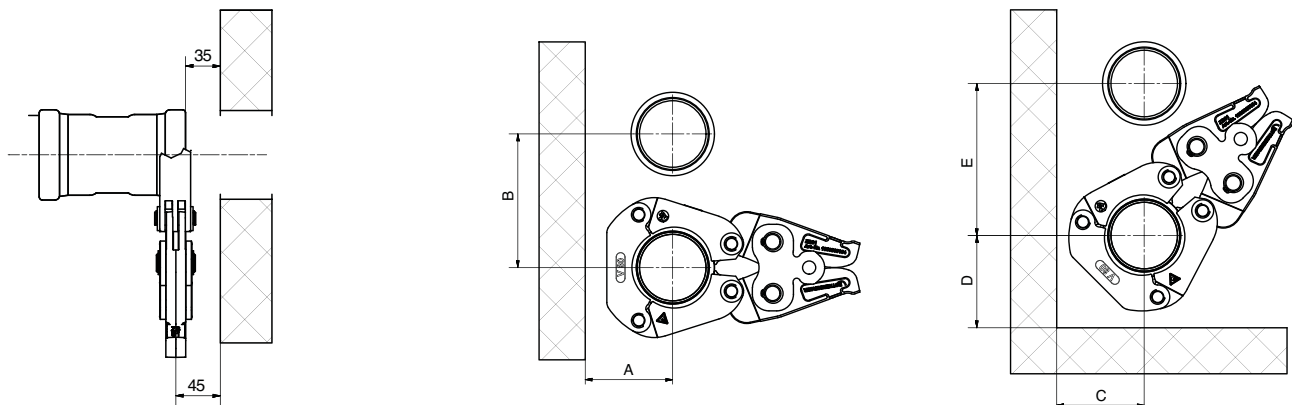

3.3.2 Minimum distances between pressings

Due to reforming of the tube profile when pressed, it is advised that a minimum distance is allowed between each fitting.

Table 18

Size (mm)	D	E	F	G
64	78.2	43.5	30	117
66.7	80.6	44	30	118
76.1	90.2	50	40	140
88.9	103.1	51	50	152
108	122.4	60.5	50	171

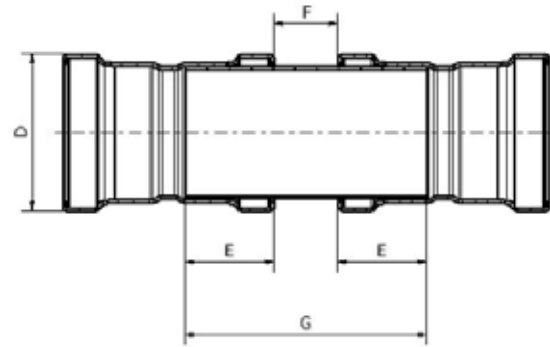

3.3.3 Minimum distance for press fittings from an existing brazed joint

To ensure proper sealing of both brazed and pressed joints, the following minimum distances must be maintained. Please see Table 16 for further information.

Table 19

Minimum distance from a brazed joint	
Tube size	mm
64	30
66.7	30
76.1	40
88.9	50
108	50

3.3.4 Minimum brazing distance to an existing pressed fitting

Caution: Brazing or soldering near >B< Press joints should be avoided as this may cause the seal to degrade due to heat transfer. Table 17 states the minimum distance away from the press joint acceptable to braze. If this distance cannot be maintained then adequate precautions must be taken such as fabricating the brazed section prior to assembly with the press fittings, wrapping in a wet rag or applying a hot block, to prevent heat transfer to the press fitting during brazing.

Table 20

Minimum distance brazing	
Tube size	mm
64	1600
66.7	2000
76.1	2000
88.9	2000
108	2000

3.3.5 >B< Press XL tube compatibility table

Table 21

Tube O/D	Tube wall thickness (mm)					
	Copper - R220		Copper - R250		Copper - R290	
64	–	–	–	–	2.0	–
66.7	–	–	1.2	–	1.2	–
76.1	–	–	1.5	–	1.5	2.0
88.9	–	–	–	–	–	2.0
108	–	–	1.5*	–	1.5*	2.5

*108 x 1.5 mm - additional requirement over EN 1057, the minimum wall thickness must not be below 1.4 mm.



3.4 >B< Press XL Installation Process

To install >B< Press XL, a press tool, actuator and compatible sized press ring to fit each size fitting is required. When force is exerted through the press tool a permanent joint is made and the fitting cannot be disassembled or reused.

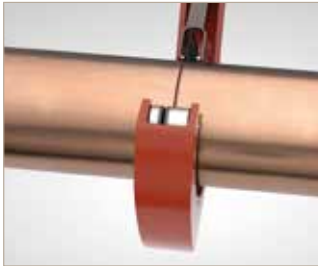

1. Cut tube to length

- We recommend you use a rotary tube cutter. It is important to ensure that the tube is cut completely square.
- Tube ends should be clean and free from scratches no less than the socket length.



2. Deburr

- Make sure that the internal and external tube end is free from burrs or sharp edges by using a half round file or deburring tool.
- Then wipe the tube end clean to avoid damaging the seal on tube insertion.



3. Clean the tube

- Thoroughly clean the tube end using a rovlie or similar cleaning pad in a rotating action.
- Tube ends must be free from scratches, oxidation, dirt and debris.

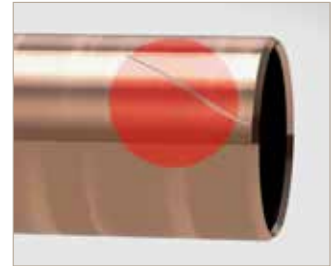

4. Check for scratches and scores

- If deep scratches are still visible, cut the tube back to a clean section and prepare the tube end again.



5. Check the fittings

- Before inserting the tube check seal for correct placement, damage or any ingress of debris.
- To prevent this occurring we recommend the fittings are retained in packaging up to the point of use.



6. Mark the insertion depth

- The tube must be fully inserted into the fitting until it reaches the tube stop in order to make a perfect joint.
- Marking insertion depth will ensure that any tube movement is detected, which is especially important if the joints are to be pressed at a later time.
- The depth marking must be visible on the pressed fitting.



7. Fit the pressing ring

- Using the appropriate size pressing ring, open the pressing ring, locate on the fitting bead and close the pressing ring.



8. Engage the actuator and check insertion depth

- With the actuator fitted in the press tool open the actuator and locate the actuator onto the aperture of the pressing ring.
- Check for any tube movement prior to pressing.



9. Press the joint

- Depress and hold the trigger of the tool until the press cycle of the tool is automatically completed. Keep hands clear of the press actuator and press ring until the cycle is completed.
- Do not repress the fitting.



10. Joint completion

- Remove the actuator from the press ring, remove the press ring from the tube and remove the label to indicate the joint is pressed and complete.

Important

It is important to keep the fitting free of any dust or dirt, and to ensure the seal stays lubricated and protected from damage. Select the correct size of tube and fitting for the job. Ensure that both are clean and free from damage and imperfections. When using a press tool always wear ear and eye protection.

3.5 The Range

P5001
90° Street Bend



P5002
90° Bend



P5040
45° Obtuse Street Elbow



P5041
45° Obtuse Elbow



P5130
Tee - Equal



P5130G
Tee with Female
Threaded Branch



P5130RB
Tee - Reduced Branch



P5230B
PN16 Flange



P5243
Fitting Reducer



P5243G
Male Threaded
Straight Connector



P5270
Straight Connector



P5270G
Threaded Female
Straight Connector



P5275
Repair Coupling



P5301
Stop End



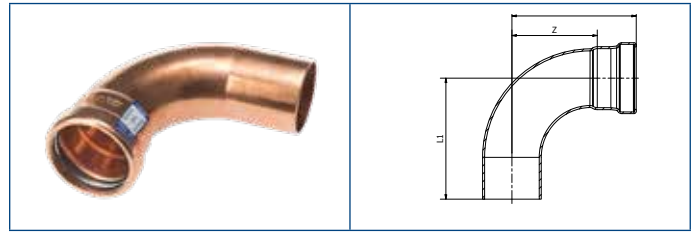

P5001 90° Street Bend

Code	Fitting size	L	L1	Z
P5001 06400000	64	133.5	140	90
P5001 06700000	66.7	141	137	97
P5001 07600000	76.1	155	167	105
P5001 08900000	88.9	168	180	117
P5001 10800000	108	205.5	217	145

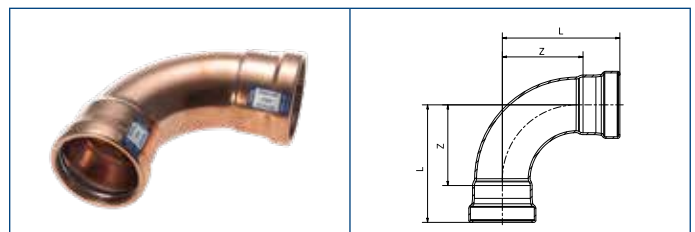

P5002 90° Bend

Code	Fitting size	L	Z
P5002 06400000	64	133.5	90
P5002 06700000	66.7	141	97
P5002 07600000	76.1	155	105
P5002 08900000	88.9	168	117
P5002 10800000	108	205.5	145

44

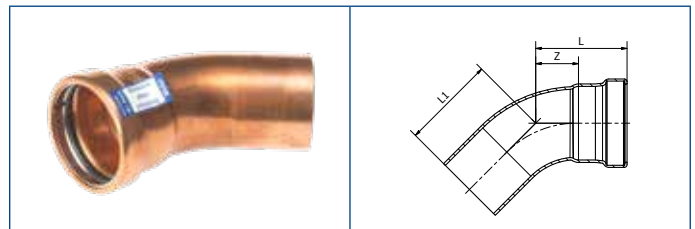

P5040 45° Obtuse Street Elbow

Code	Fitting size	L	L1	Z
P5040 06400000	64	79.5	86.5	36
P5040 06700000	66.7	83	85.5	39
P5040 07600000	76.1	95	100	45
P5040 08900000	88.9	101	106.5	50
P5040 10800000	108	115.5	127	55

**P5041
45° Obtuse Elbow**

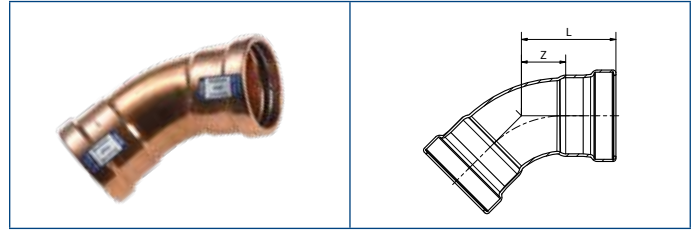

Code	Fitting size	L	Z
P5041 06400000	64	79.5	36
P5041 06700000	66.7	83	39
P5041 07600000	76.1	95	45
P5041 08900000	88.9	101	50
P5041 10800000	108	115.5	55

**P5130
Equal Tee**

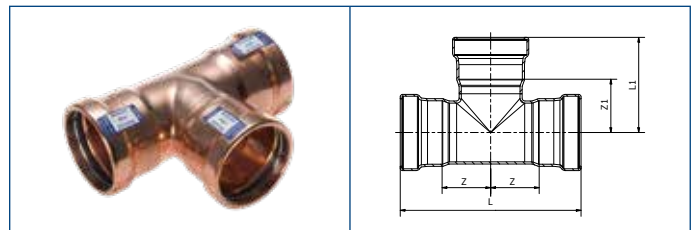

Code	Fitting size	L	L1	Z	Z1
P5130 06464064	64	179	88	46	44
P5130 06767067	66.7	191	96	51.5	52
P5130 07676076	76.1	207	103	53.5	53
P5130 08989089	88.9	216.5	111	57	60
P5R 108108108	108	265	130	72	69.5

P5130G (ISO 7-1)
Tee with Female Threaded Branch**

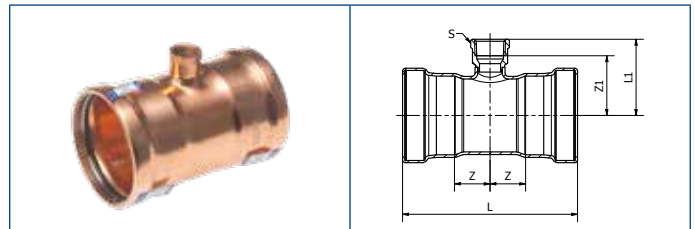

Code	Fitting Size	L	L1	Z	Z1	S
P5130G06406640	64 x 3/4" x 64	144	60	28.5	45.5	31
P5130G06408640	64 x 1" x 64	151	64	32	47	40
P5130G06416640	64 x 2" x 64	179	66	46	45.5	66.5
P5130G06706670	66.7 x 3/4" x 66.7	150	60	31	45.5	31
P5130G06716670	66.7 x 2" x 66.7	185	66	48.5	45.5	66.5
P5130G07606760	76.1 x 3/4" x 76.1	162.5	65	31	50.5	31
P5130G07616760	76.1 x 2" x 76.1	197.5	71	48.5	50	66.5
P5130G08906890	88.9 x 3/4" x 88.9	160.5	71.5	29	57	31
P5130G8916890	88.9 x 2" x 88.9	195.5	77.5	46.5	57	66.5
P5RG108061080	108 x 3/4" x 108	190	82	34.5	67.5	31
P5RG108161080	108 x 2" x 108	225	88	52	67.5	66.5

*All above measurements are in mm unless stated differently. ** Product description reads end, branch, end.

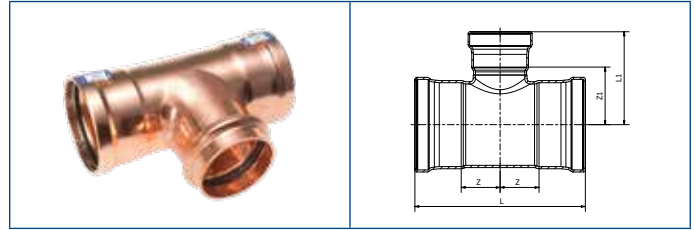

P5130RB** Tee - Reduced Branch

Code	Fitting size	L	L2	Z	Z1
P5130 06435640	64 x 35 x 64	151	67.5	32	40
P5130 06442640	64 x 42 x 64	158	76	35.5	40
P5130 06454640	64 x 54 x 64	169	80	41	40
P5130 06728670	66.7 x 28 x 66.7	150	64	31	40
P130 06735670	66.7 x 35 x 66.7	157	66	34.5	40
P5130 06742670	66.7 x 42 x 66.7	164	76	38	40
P5130 06754670	66.7 x 54 x 66.7	175	80	43.5	40
P5130 07628760	76.1 x 28 x 76.1	162.5	69.5	31	45.5
P5130 07635760	76.1 x 35 x 76.1	169.5	71	35	45
P5130 07642760	76.1 x 42 x 76.1	178	81	39	45
P5130 07654760	76.1 x 54 x 76.1	187	85	43.5	45
P5130 07664760	76.1 x 64 x 76.1	197.5	92.5	48.5	49
P5130 07667760	76.1 x 66.7 x 76.1	197.5	100.5	48.5	56.5
P5130 08954890	88.9 x 54 x 88.9	185.5	91.5	42	51.5
P5130 08964890	88.9 x 64 x 88.9	195.5	99	47	55.5
P5130 08976890	88.9 x 76.1 x 88.9	203.5	109	51	59
P5R 0108054108	108 x 54 x 108	215	101	47	61
P5R 0108064108	108 x 64 x 108	225	108.5	52	65
P5R 0108076108	108 x 76.1 x 108	233	118.5	56	68.5
P5R 0108089108	108 x 88.9 x 108	246	120.5	62.5	69.5

46

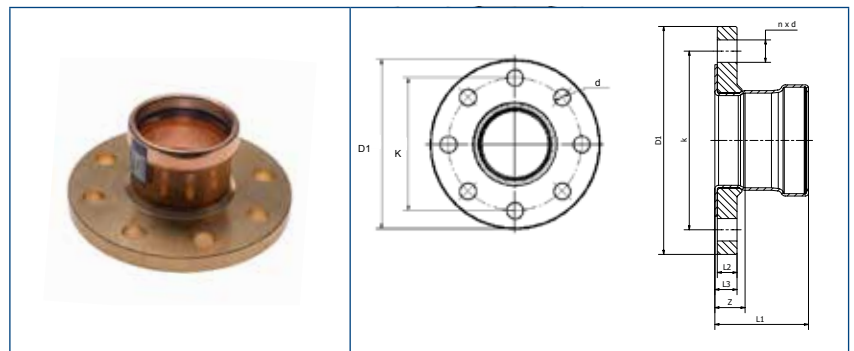

P5230B (EN 1092-1) PN16 Flange 45°

Code	Fitting size	L1	L2	L3	Z	D1	k	n	d
P5230B06400000	64	76.5	16	18	23	185	145	8	18
P5230B06700000	66.7	88	16	18	25	185	145	8	18
P5230B07600000	76.1	88	16	18	25	185	145	8	18
P5230 076000UK*	76.1	88	18	18	25	200	160	8	18
P5230B08900000	88.9	89	18	20	29	200	160	8	18
P5230B10800000	108	99	18	21	31	220	180	8	18

*Manufactured to BS 4504 standard.

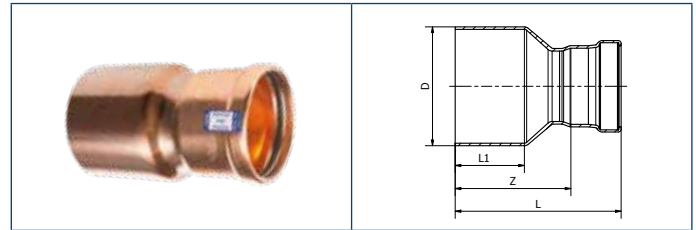

**P5243
Fitting Reducer**

Code	Fitting size	D	L	L1	Z
P5243 06435000	64 x 35	64	103	45	77
P5243 06442000	64 x 42	64	109	45	73
P5243 06454000	64 x 54	64	105	45	65
P5243 06728000	67 x 28	66.7	107	46	83
P5243 06735000	67 x 35	66.7	106	46	80
P5243 06742000	67 x 42	66.7	112	46	76
P5243 06754000	67 x 54	66.7	108	46	68
P5243 07628000	76 x 28	76.1	118	52	94
P5243 07635000	76 x 35	76.1	116	52	90
P5243 07642000	76 x 42	76.1	122	52	86
P5243 07654000	76 x 54	76.1	120	52	80
P5243 07664000	76 x 64	76.1	117	52	73.5
P5243 07667000	76 x 67	76.1	121	52	76.5
P5243 08954000	89 x 54	88.9	128	53	88
P5243 08964000	89 x 64	88.9	124	53	80.5
P5243 08976000	89 x 76	88.9	129	53	79
P5243 10854000	108 x 54	108	150	62	110
P5243 10864000	108 x 64	108	148	62	104.5
P5243 10876000	108 x 76	108	152	62	102
P5243 10889000	108 x 89	108	144	62	93

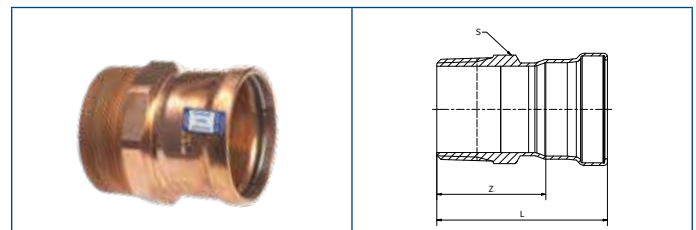

**P5243G (ISO 7-1)
Male Threaded Straight Connector**

Code	Fitting size	L	Z	S
P5243G06420000	64 x 2 1/2"	106	63	80
P5243G06720000	67 x 2 1/2"	114	70	80
P5243G07620000	76 x 2 1/2"	114.5	64.5	80
P5243G07624000	76 x 3"	115	65	90
P5243G08924000	89 x 3"	115	64	90
P5243G10832000	108 x 4"	131.5	71	115

*All above measurements are in mm unless stated differently.

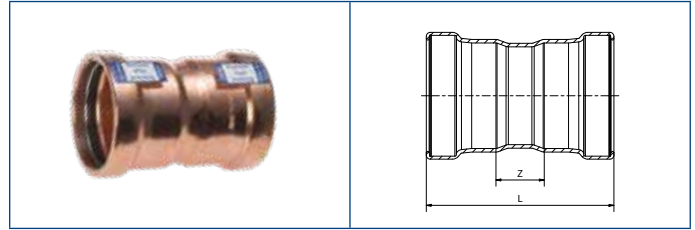

P5270 Straight Connector

Code	Fitting size	L	Z
P5270 06400000	64	101.5	58.5
P5270 06700000	66.7	109	65
P5270 07600000	76.1	123	73
P5270 08900000	88.9	122	71
P5270 10800000	108	145	84.5

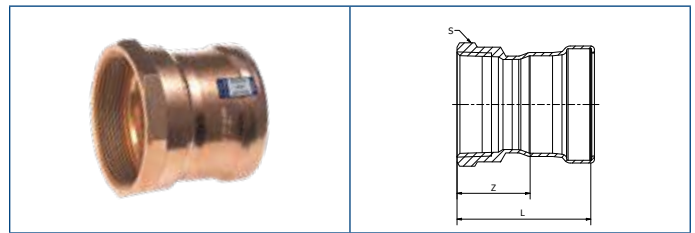

P5270G (ISO 7-1) Female Threaded Straight Connector

Code	Fitting size	L	Z	S
P5270G06420000	64 x 2 1/2"	96	22	85
P5270G06720000	67 x 2 1/2"	102.5	28.5	85
P5270G07620000	76 x 2 1/2"	99	19	85
P5270G07624000	76 x 3"	109	26	85
P5270G08924000	89 x 3"	104.5	20.5	95
P5270G10832000	108 x 4"	123	23.5	125

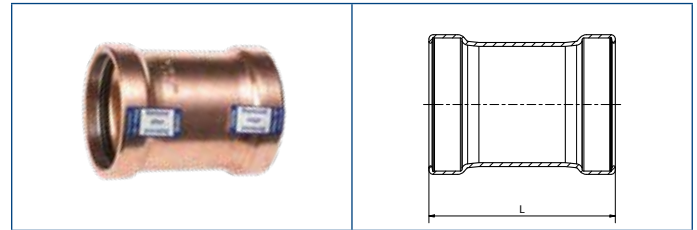

**P5275
Repair Coupling**

Code	Fitting size	L
P5275 06400000	64	101.5
P5275 06700000	66.7	109
P5275 07600000	76.1	123
P5275 08900000	88.9	122
P5275 10800000	108	145

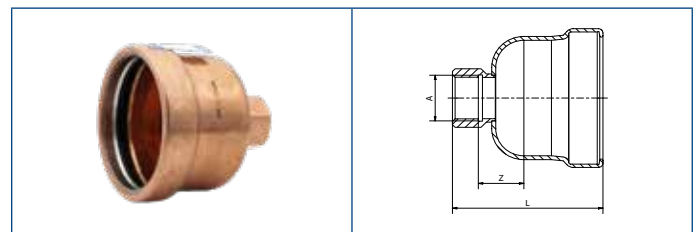

**P5301 (ISO 7-1)
End Cap**

Code	Fitting size	L	Z	A
P5301 06400000	64	83.5	27	3/4"
P5301 06700000	66.7	84	27	3/4"
P5301 07600000	76.1	94	31	3/4"
P5301 08900000	88.9	100	36	3/4"
P5301 10800000	108	117.5	44	3/4"

* The end cap requires a sealing plug which is not provided.

Conex | Bänninger

>B< Press

>B< Press Gas

>B< Press Solar

>B< Press XL

>B< Press Carbon

>B< Press Inox

>B< MaxiPro

>B< ACR

K65

<A> Press Inox

>B< Push

>B< Sonic

>B< Oyster

>B< Flex

Triflow Solder Ring

Delcop End Feed

Delbraze

Medical Gas

Valves

Conex Compression

Series 3000

Series 4000

Series 5000

Series 8000

OEM Solutions



United Kingdom
Conex Universal Limited

Germany
IBP GmbH

Spain
IBP Atcosa SL

France
Conex Bänninger SRL

Italy
IBP Bänninger Italia srl

Poland Sales, Marketing and Logistics
IBP Instalittings Sp z.o.o.

USA
IBP Group LLC

China
IBP China

Tel: +44 (0)121 557 2831 | Fax: +44 (0)121 557 0185 | Email: salesuk@ibpgroup.com | www.conexbanninger.com

The content of this publication is for general information only. It is the user's responsibility to determine suitability of any product, product data and specifications, for the purpose intended and reference should be made to our Technical Department if clarification is required – technical@ibpgroup.com. All products must be installed in accordance with our installation instructions. In the interests of technical development we reserve the right to change specification, design and materials without notice.

Conex Bänninger products are approved by numerous Standards Authorities and Certification Bodies. This is a representation of the full range from Conex Universal Ltd. Patents and trademarks are registered in numerous countries. Details on registered and pending patents protecting our products is available at public patent registers or can be requested from legal@ibpgroup.com. All documents, images and technical data are © of Conex Universal Limited. E&OA.

More information online at: www.conexbanninger.com