



THE TILING ACCESSORY SPECIALISTS

PRODUCT GUIDE 2019

ANTI CRACK
MATTING

WATERPROOF
MATTING

THERMABOARD

LEVELLING SYSTEMS
& TILE SPACERS

DRILLS &
HOLE SAWS

METAL TILE
EDGE

FLOOR
TRIMS

PVC TILE
EDGE

BATH
TRIMS

TILE CUTTING
MACHINES

POWER MIXERS &
ACCESSORIES

HAND CUTTING
TOOLS

GENERAL
TILING TOOLS

ADHESIVE
TROWELS

GROUT FLOATS &
SPREADERS

GROUT
CLEANING

CLEAN &
SEAL RANGE



FOR MORE INFORMATION OR TO ORDER
CALL US ON: 01543 500 893

WELCOME TO OUR NEW CATALOGUE

FULL OF EXCITING NEW SOLUTIONS,
CRACKING PRICES ON A DIZZYING
RANGE OF WONDERFUL PRODUCTS... ALL
DESIGNED TO MAKE YOUR LIFE EASIER!

HOW TO ORDER!

1. FIND YOUR PRODUCTS

In our catalogue, online, or by simply calling us.



2. CHECK DETAILS

More information is held online with data sheets or call.



3. CHECK PRICES

On the price sheets, or on your customer portal online.



4. ORDER BY TELEPHONE, EMAIL OR WEB

Always use our product codes when ordering by phone or email to ensure error free processing. If you want to order using our Online Portal, give us a call and we can set this up for you.



CALL:
01543
500 893

VISIT:
TILERITE.CO.UK





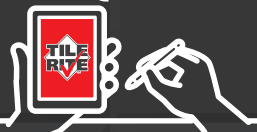













EMAIL:
sales@tilerite.co.uk



WELCOME

CONTENTS

	ANTI CRACK MATTING	06
	WATERPROOF MATTING	09
	THERMABOARD	12
	LEVELLING SYSTEMS & TILE SPACERS	14
	DRILLS & HOLE SAWS	22
	METAL TILE EDGE	29
	FLOOR TRIMS	41
	PVC TILE EDGE	45
	BATH TRIMS	51
	TILE CUTTING MACHINES	54
	POWER MIXERS & ACCESSORIES	64
	HAND CUTTING TOOLS	67
	GENERAL TILING TOOLS	75
	ADHESIVE TROWELS	84
	GROUT FLOATS & SPREADERS	91
	GROUT CLEANING	94
	CLEAN & SEAL RANGE	99



FOR MORE INFORMATION OR TO ORDER
VISIT: WWW.TILERITE.CO.UK

CONTENTS



FOR MORE INFORMATION OR TO ORDER
CALL US ON: 01543 500 893

TILE RITE

TILE RITE

WHO WE ARE...

We are a well-established family run business supplying specialised tiling tools and accessories to the retail trade.

WHAT WE DO...

Tile Rite strive to source and manufacture exciting new solutions for all your tiling needs. We believe in providing a personal service to our customers, building relationships and providing human touches. Tile Rite are well established, we have grown over the past 30 years and want to help you grow too.

WHY WE DO IT...

Our Managing Director has over 40 years' experience in sourcing tiling accessories and has extensive knowledge when it comes to manufacturing aluminium profiles, ensuring that we provide the highest quality at the best possible prices. We also believe in relationships and providing a personal service, which is ever more important to us in this digital age.

WHERE WE ARE...

We are based in Staffordshire, but our sales team is nationwide. Pick up the phone and give us a call.

OUR TEAM

Our 'On the Road' Sales Team

Our long serving sales team have a wealth of knowledge and are generally likeable too! It's nice to talk to a person especially in this digital age, and we have 8 of them Nationwide to make your dealings with us easy!

We also have a dedicated team of merchandisers to increase your sales and buyer attention thorough creating attractive visual displays.

Our Office Team

We believe familiarity is important to our customers, so you can be sure of speaking with a dedicated member of staff every time you pick up the phone. Our Office Manager David Montgomery is your man for orders, Marion Yarsley for anything regarding Shipping, Gill Lake for Accounts, Laura Harbidge for Marketing and Roberto Harbidge for everything else!



James Harbidge

Sales Director
Midlands & North London



MOBILE: 07974 179 663



Colin Whittingham

Senior Sales Executive
West Midlands & Key



MOBILE: 07976 390 092



Paul Duckworth

Senior Sales Executive
North & Ireland



MOBILE: 07976 384 712



Richard Tinker

Sales Executive
North & Scotland



MOBILE: 07740 850 869



Steve Burton

Sales Executive
South



MOBILE: 07932 366 204



Steve Grainger

Sales Merchandiser
North



MOBILE: 07747 568 952



Shaun Baxter

Sales Merchandiser
Midlands & South



MOBILE: 07889 536 756



Pete Neale

Sales Merchandiser
South Wales & Birmingham



MOBILE: 07813 919 703



**OR CALL US ON 01543 500 893
& WE'LL CONNECT YOU WITH THE
BEST PERSON TO HELP YOU.**

REASONS TO CHOOSE TILE RITE



NEW EXCLUSIVE PRODUCTS

We are constantly striving to source new and exciting solutions for all your tiling needs. Look out for our 'NEW' icon for all of our latest product launches.



FANTASTIC VALUE AND SAVINGS

For quantity discounts and information on current offers please contact your sales representative.



TRUSTED FOR 30 YEARS

We have spent the last 30 years building a company that you can feel secure about. As one of the leading brands within this sector, we have the expertise to help you grow too!



SPEEDY AND RELIABLE DELIVERY

Lead times may vary during busy trading periods, however we always aim to deliver by the next working day, with orders placed before 2pm.



EXPERT ADVICE ON HAND AT ALL TIMES

Both internal and external sales staff are on hand to offer sales and advice on our products. Detailed product information is also available on our website. www.tilerite.co.uk



QUALITY APPROVED & ACCREDITED PRODUCTS

Tile Rite products are ethically sourced from quality approved manufacturers in England, Europe and China.



FOR MORE INFORMATION OR TO ORDER
CALL US ON: 01543 500 893

ANTI CRACK MATTING

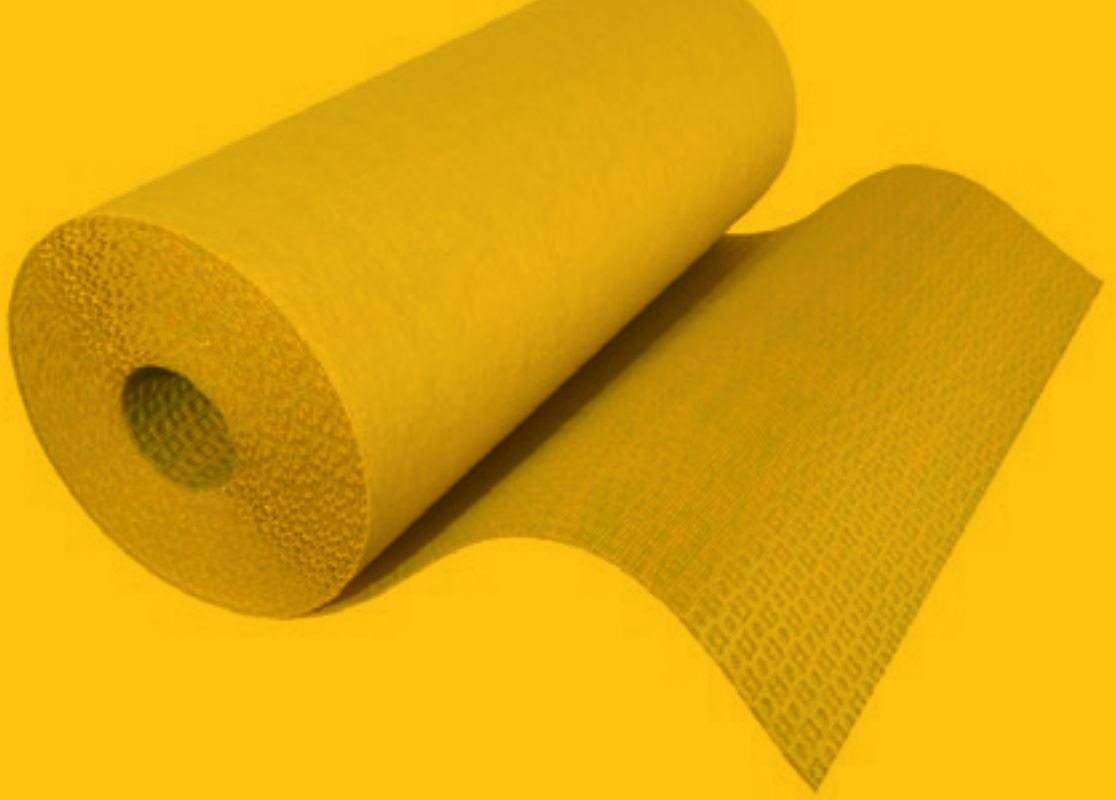

ANTI CRACK MATTING

**UNDERLAY MATTING
FOR THE DECOUPLING
& WATERPROOFING OF
TILED SURFACES.**

THE PROBLEMS

- ✓ **CRACKS IN THE SUB FLOOR.**
Cracks in both existing and new sub floors can be transmitted into the newly tiled surface.
- ✓ **STRESSES IN THE SUB FLOOR.**
Subfloor stress can occur for many reasons; concrete floors will continue to shrink and expand for long periods of time after installation. Wooden substrates can be affected by moisture in the air. Underfloor heating will also dramatically increase the degree of movement within such floors. This "hot and cold" cycle places great stress on the tiled covering.
- ✓ **DAMP FROM THE SUBFLOOR.**
Residual moisture from the screed itself can collect under the tiles and cause damage to the adhesive layer.
- ✓ **MOISTURE MIGRATION.**
Damage caused when tiled bathrooms and wet areas are not sealed properly resulting in damp patches on ceilings below bathrooms, damage to timber frames & building joists etc.

THE SOLUTION

- ✓ Using anti crack matting will absorb substrate movement to prevent surface cracks & the delamination of tile and stone. The matting decouples the tiles, bridges any cracks in the substrate, provides waterproofing (when used with waterproof joint tape) and facilitates compensation for water vapor pressure if residual moisture is present.

PRO+MAT ANTI CRACK FLOOR MATTING



This Newly developed waterproof heavy duty anti crack mat is used under tiles to prevent surface cracks, moisture migration and the de-lamination of tile & stone. Can be applied over challenging substrates such as green screed and single layer plywood.

USES:

Tile Rite Pro+Mat is elastic, rot proof and resistant to aggressive substances and liquids such as alkalis, solvents and oils. It bridges cracks, uncouples floor assemblies from their substrates and is suitable as an underlayment for floor tiles.

AREAS OF USE:

For interior and exterior applications: Concrete (green screed, mortar beds, masonry, lightweight concrete and/or air entrained concrete, primed gypsum underlayment (minimum 200 PSI cured), post tension concrete), exterior grade plywood (ECP), OSB, exterior decks, ceramic tile, resilient flooring, cutback adhesive and poured asphalt tarmac.

WATERPROOFING:

Tile Rite Pro+Mat is waterproof and offers vapour management. For a waterproof installation, apply Tile Rite waterproof seam tape evenly over seams & changes in plane. Preformed internal & external corners are also available to achieve a watertight seal.



CODE	BARCODE	LENGTH	WIDTH	PALLET QTY
PRO905	5019788009056	5m	1m	40
PRO930	5019788009308	30m	1m	8



FOR MORE INFORMATION OR TO ORDER
CALL US ON: 01543 500 893

ANTI CRACK MATTING

DURABASE CI++ ANTI CRACK FLOOR MATTING

Used in conjunction with tiles, DURABASE CI++ decouples the tiles, bridges any cracks and has a waterproofing function.

- ✓ It also facilitates compensation for water vapour pressure if residual moisture is present.
- ✓ Ideal for renovation work.



CODE	BARCODE	LENGTH	WIDTH	PALLET QTY
DUR047	5019788000473	5m	1m	24
DUR709	4018448063811	30m	1m	6

ANTI CRACK WATERPROOF FLOOR MATTING

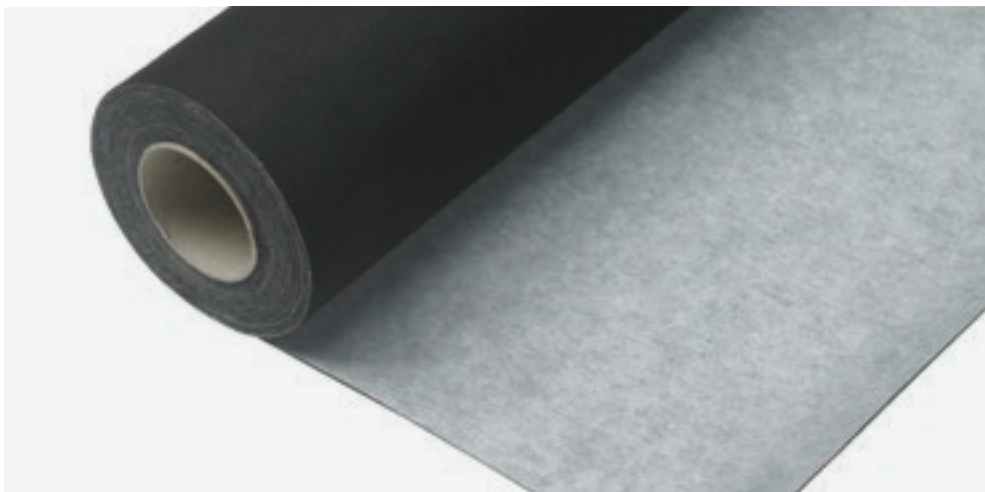

Use under tile or stone over any 18mm substrate, e.g. over cement, CDX or OSB board.

- ✓ Quick & easy to install.
- ✓ The mat prevents surface cracking by compensating for shear forces between tiling & the floor.
- ✓ 100% waterproof when used with joint tape & accessories.
- ✓ Can be laid on wood, concrete & cement.
- ✓ No waiting or drying time! You are able to install tiles immediately once matting is applied.
- ✓ Ideal for use with underfloor heating.

CODE	BARCODE	LENGTH	WIDTH
WFM464	5019788004648	5m	1m
WFM457	5019788004570	20m	1m

DID YOU KNOW?
THAT THIS IS ONLY
0.85mm THICK &
COMES WITH A 10
YEAR WATERPROOF
GUARANTEE!*



*Use in conjunction with waterproof floor matting & accessories for a 10-year guarantee.



WATERPROOF MATTING

**WATERPROOF YOUR BATHROOM
100% GUARANTEED**

WHAT'S THE PROBLEM?

- ✓ Water penetrates or seeps into the wall / floor joints.
- ✓ Leaks in bathroom which have built up over time.
- ✓ Bathrooms not sealed properly.
- ✓ Damp patches in rooms below from leaks!

WHY DOES THE PROBLEM EXIST?

- ✓ Grouts & adhesives are only water resistant...not waterproof!
- ✓ Over time grout joints will allow water to penetrate below the tile.
- ✓ Water & Moisture can still migrate to the substrate below
- ✓ Mastics & Silicones can crack, and seals can be broken.
- ✓ Subsidence can cause seals to break & tiles to move & crack.

WHY IS MATTING THE SOLUTION?

- ✓ Waterproofing against water & moisture is critical to protect any construction or building and helps to prevent the following:
- ✓ Water penetration to other living spaces.
- ✓ Expensive repairs.
- ✓ Cracks in walls.
- ✓ Cracks in the ceramic layer.
- ✓ Ceramic tiles may lift off.

AREAS OF APPLICATION

Any area to be tiled that is subject to dampness!

- ✓ **INTERIOR USES:**
Bathrooms / Showers /
Wet Rooms / Changing Rooms /
Laundry Rooms / Doorways.
- ✓ **EXTERIOR USES:**
Decks / Patios /
Terraces / Balconies.

WATERPROOF MATTING



FOR MORE INFORMATION OR TO ORDER
CALL US ON: 01543 500 893

WATERPROOF MATTING

WATERPROOF WALL MATTING

Tile Rite waterproof wall matting is your simple solution to permanent waterproofing.

THE PROBLEM

Damage caused when tiled bathrooms and wet areas are not sealed properly, resulting in damp patches on ceilings below bathrooms and damage to timber frames, building joists and plasterboard etc.

THE CAUSES

Moisture migration through permeable tiles and grout lines. Water seeping behind dry, cracked and broken mastic or silicone seals around baths & showers. Moisture seeping behind tiles that have delaminated from their original position.

- ✓ Quick & easy to install.
- ✓ Your wet room or walk in shower will be completely sealed from water & moisture penetration to the surfaces beneath.
- ✓ No waiting or drying time! You are able to install tiles immediately once matting is applied.
- ✓ Only 0.7mm thick with no weak points.

CODE	BARCODE	LENGTH	WIDTH
WWM463	5019788004631	5m	1m
WWM456	5019788004563	20m	1m

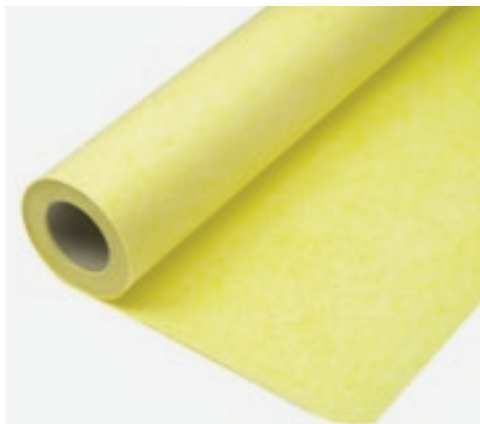

WOW! THIS COMES WITH A 10 YEAR GUARANTEE*



*Use in conjunction with waterproof floor matting & accessories for a 10-year guarantee.

WATERPROOF FLOOR MATTING

Tile Rite waterproof floor matting is your simple solution to de-coupling & permanent waterproofing.

Use under tile or stone over any 18mm substrate, e.g. over cement, CDX or OSB board. The mat prevents surface cracking by compensating for shear forces between tiling & the floor.

- ✓ Quick & easy to install.
- ✓ Your wet room or walk in shower will be completely sealed from water & moisture penetration to the surfaces beneath.
- ✓ Absorbs substrate movement to prevent surface cracks & the delamination of Tile & Stone.
- ✓ Can be laid on wood, concrete & cement.
- ✓ No waiting or drying time! you are able to install tiles immediately once matting is applied.
- ✓ Ideal for use with underfloor heating.
- ✓ Only 0.85mm thick with no weak points.
- ✓ 10 Year guarantee for a 100% waterproof seal
*when used with wall matting joint tape & accessories.

CODE	BARCODE	LENGTH	WIDTH
WFM464	5019788004648	5m	1m
WFM457	5019788004570	20m	1m

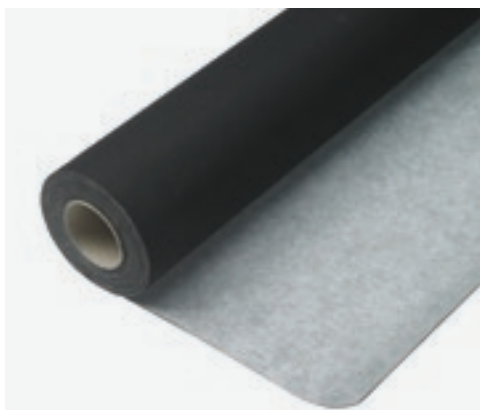

DID YOU KNOW? THIS COMES WITH A 10 YEAR GUARANTEE*



*Use in conjunction with waterproof floor matting & accessories for a 10-year guarantee.

FLEXIBLE WATERPROOF JOINT TAPE



This seam tape should be used to cover any joints between waterproof wall and floor matting or Pro+Mat to create a watertight seal.

The premium material allows for more 3D movement, eliminating the risks of leaks. Apply using a powder-based adhesive. Always centre the tape over the joint and ensure 100% contact.

CODE	BARCODE	LENGTH	WIDTH
FJT465	5019788004655	5m	120mm

FLEXIBLE INTERNAL CORNER



This preformed corner piece is used to cover any internal corner joints between waterproof wall & floor matting or Pro+Mat.

The premium 3D material allows for more 3D movement, eliminating the risk of leaks. Always centre the corner over the joint and ensure 100% contact. Apply using a powder-based adhesive.

CODE	BARCODE	LENGTH
FIC467	5019788004679	ONE SIZE

FLEXIBLE EXTERNAL CORNER



This preformed corner piece is used to cover any external corner joints between waterproof wall & floor matting or Pro+Mat.

The premium 3D material allows for more 3D movement, eliminating the risk of leaks. Always centre the corner over the joint and ensure 100% contact. Apply using a powder-based adhesive.

CODE	BARCODE	LENGTH
FEC466	5019788004662	ONE SIZE

FLEXIBLE PIPE COLLAR

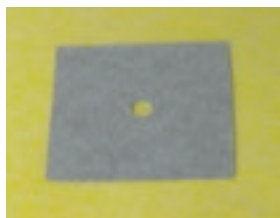

Use the flexible pipe collar around the base of 15-18mm water or radiator pipes. The premium 3D material allows for more 3D movement, eliminating the risk of leaks.

Use with Tile Rite waterproof matting to create a permanent waterproof seal. Ensure 100% contact. Apply using a powder-based adhesive.

CODE	BARCODE	LENGTH
FPC468	5019788004686	ONE SIZE

BATH & SHOWER SEAL TAPE



Use on the outside of bath or shower trays prior to installation for a waterproof seal.

For best results use in conjunction with waterproof wall matting & accessories. Apply by fixing the self-adhesive strip to the outside of the bath/shower tray where it will meet the walls. Overlap with the waterproof wall matting to completely cover your wall.

CODE	BARCODE	LENGTH	WIDTH
BST130	5019788001302	3.5m	120mm

DURABASE (WP) SEALING TAPE



This waterproof seam tape should be used at matting junctions and changes of plane to create a watertight seal.

Apply centrally over the joint using a powder-based adhesive.

CODE	BARCODE	LENGTH	WIDTH
DJT696	5019788006963	10m	150mm
DJT549	5019788005492	25m	150mm



FOR MORE INFORMATION OR TO ORDER
CALL US ON: 01543 500 893

THERMABOARD



THERMABOARD

THERMABOARD IS YOUR COMPLETE COST EFFECTIVE SOLUTION FOR WATERPROOFING & INSULATION IN ONE SIMPLE OPERATION.

Thermaboard can replace plasterboard and plywood on a structurally secure substrate and are ideal surfaces for thin bed tiling on walls and floors, and can be fixed to any suitable framework such as brick, concrete, wood or metal. It is simple and easy to fix, and is lightweight and easy to cut with a saw or knife. Thermaboards are completely water resistant when joints are sealed with Tile Rite water proof joint tape.

Thermaboards can also improve under floor heating efficiency up to 50%. The thicker the board the greater the thermal properties. Thermaboards can hold a tile weight of 62kg/m².

INSULATING & WATERPROOF TILE BACKER BOARD

- ✓ Thermaboard is ideal for many applications including waterproofing, insulating and dry lining.
- ✓ Thermaboard can be used to insulate and waterproof walls, floors and ceilings and are available in 6, 8, 10, 12 & 20mm thicknesses. The thicker the board the greater the thermal properties.

WHAT ARE THERMABOARDS MADE FROM?

- ✓ Thermaboards are made from extruded polystyrene with high water proofing and insulation properties. Each side of the board is covered with a fibre mesh (to provide mechanical resistance) and embedded in a polymerised cement mortar. This combination provides to the system a very good mechanical resistance, waterproofing and bond to tile adhesive.

THERMABOARD BENEFITS

- ✓ Versatile: Can replace plasterboard & plywood on a structurally secure substrate to provide a smooth surface to tile on to.
- ✓ Waterproof: Totally impervious to moisture, providing a waterproof barrier when used in conjunction with waterproof joint tape.
- ✓ Insulating: Creates a thermal layer improving under floor heating efficiency up to 50%.
- ✓ High Strength: Tested to hold a tile weight of 62kg/m².
- ✓ Suitable for use with all types of under floor heating.
- ✓ Boasts sound reduction properties.
- ✓ Lightweight and easy to cut making preparation time faster .
- ✓ Rigid and strong providing a stable surface to tile on to.
- ✓ Rot-proof

THERMABOARD

Tile Rite Thermaboard is an insulating, rot proof, waterproof tile backer board ideal for many applications including waterproofing, insulating and dry lining.

Thermaboard can be used to insulate and waterproof walls, floors & ceilings. The thicker the board the greater the thermal properties.

- ✓ **Versatile:** Can replace plasterboard & plywood on a structurally secure substrate to provide a smooth surface to tile on to.
- ✓ **Waterproof:** When used with waterproof joint tape.
- ✓ **Insulating:** Creates a thermal layer improving underfloor heating efficiency up to 50%.
- ✓ **High Strength:** Tested to hold a tile weight of 62kg/m².



CODE	BARCODE	DEPTH	LENGTH	WIDTH
THB810	5019788008103	6mm	1200mm	600mm
THB811	5019788008110	10mm	1200mm	600mm
THB814	5019788008141	12mm	1200mm	600mm
THB817	5019788008172	20mm	1200mm	600mm

FIBERGLASS JOINT TAPE



Fibreglass tape should be used as a seam tape to reinforce the joints where thermaboards meet.

- ✓ Self adhesive for ease of fixing.
- ✓ Helps prevent any movement.
- ✓ If waterproofing is required replace glass fibre tape with a waterproof seam tape from the waterproof matting range.

CODE	BARCODE	LENGTH	WIDTH
TBT536	5019788005362	20m	50mm

THERMABOARD WASHERS



Thermaboard washers are used with screws to strengthen the anchorages and connections between boards. Galvanised to provide long term durability.

CODE	BARCODE	PK QTY
THB828	5019788008288	100pcs

GALVANISED SCREWS



Use with thermaboard washers to strengthen the anchorages and connections between boards. Galvanised to provide long term durability. Always check screw length suitability before fixing.

CODE	BARCODE	LENGTH	PK QTY
THS322	5019788003221	40mm	200pcs
THS829	5019788008295	60mm	100pcs



FOR MORE INFORMATION OR TO ORDER
CALL US ON: 01543 500 893

LEVELLING SYSTEMS & TILE SPACERS

LEVELLING SYSTEMS & TILE SPACERS

TILES EXPAND & CONTRACT EVEN WHEN FIXED. IF TILES WERE NOT SPACED THEY WOULD PUSH AGAINST EACH OTHER, CRACK AND COME LOOSE. TILE SPACERS MAKE SURE THAT YOUR SPACES ARE EVEN AND GIVE A PROFESSIONAL LOOK TO THE FINISHED INSTALLATION.

Spacer width is a personal preference however traditionally 2mm was used for walls and 3mm for floors.

Check out our Levelling Spacer System for even grout lines and no lippage! The levelling spacer system gives you PERFECT tile-to-tile alignment.

Within this section

- ✓ Levelling Spacer System
- ✓ Long Legged Tile Spacers
- ✓ Specialist Spacers
- ✓ Traditional Spacers

LEVELLING STARTER KIT



The Tile Rite Levelling Starter Kit ensures that your large format Porcelain, Marble or Stone tiles are perfectly aligned and held level.

The spacer ensures even 1mm or 2mm grout lines, and the wedge pulls the tile level to eliminate any lippage.

Kit comprises of 100 spacers, 100 wedges and a pair of pliers.

This easy to use system benefits from these key features.

- ✓ Prevents uneven tiles.
- ✓ Ensures even grout lines.
- ✓ Easy to use.
- ✓ For floor & wall tiles.
- ✓ Holds tile level.
- ✓ Perfect tile to tile alignment.
- ✓ For tiles from 2-12mm thick.
- ✓ May be combined with regular tile spacers for joints up to 6mm wide.
- ✓ Guiding spine in centre of wedge works with groove in spacer to ensure wedge stays straight, level & secure when fitting.
- ✓ Spacer size stamped in to top of spacer.
- ✓ Notches in side of spacer ensures a clean detachment of the spacer top from the base.
- ✓ Starter kit available with 1mm or 2mm spacers.



TOP TIP: COVERAGE GUIDE

Rectangular Tiles

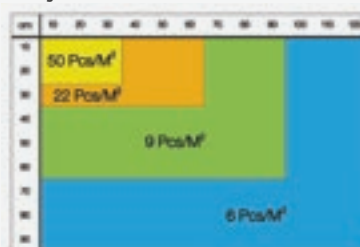

Square Tiles

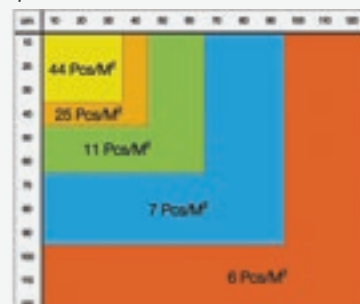

CODE	BARCODE	SIZE	DEPTH
LSB850	5019788008509	1mm	2-12mm
LSB481	5019788004815	2mm	2-12mm



FOR MORE INFORMATION OR TO ORDER
CALL US ON: 01543 500 893

LEVELLING SYSTEMS &
TILE SPACERS

1MM STANDARD HEIGHT LEVELLING TILE SPACER



Use with levelling wedges for perfect tile to tile alignment.

- ✓ Ensures even 1mm grout lines.
- ✓ For tiles from 2-12mm thick.
- ✓ For wall & floor tiling.

CODE	BARCODE	SIZE	DEPTH	PK QTY
LSS844	5019788008448	1mm	2-12mm	25pcs
LSS853	5019788008530	1mm	2-12mm	100pcs
LSS880	5019788008806	1mm	2-12mm	250pcs

2MM STANDARD HEIGHT LEVELLING TILE SPACER



Use with levelling wedges for perfect tile to tile alignment.

- ✓ Ensures even 2mm grout lines.
- ✓ For tiles from 2-12mm thick.
- ✓ For wall & floor tiling.

CODE	BARCODE	SIZE	DEPTH	PK QTY
LST856	5019788008561	2mm	2-12mm	100pcs
LST881	5019788008813	2mm	2-12mm	250pcs

3MM STANDARD HEIGHT LEVELLING TILE SPACER



Use with levelling wedges for perfect tile to tile alignment.

- ✓ Ensures even 3mm grout lines.
- ✓ For tiles from 2-12mm thick.
- ✓ For wall & floor tiling.

CODE	BARCODE	SIZE	DEPTH	PK QTY
LST882	5019788008820	3mm	2-12mm	100pcs
LST883	5019788008837	3mm	2-12mm	250pcs

2MM DEEP LEVELLING TILE SPACER



Use with levelling wedges for perfect tile to tile alignment.

- ✓ Ensures even 2mm grout lines.
- ✓ For tiles from 12-20mm thick.
- ✓ For wall & floor tiling.

CODE	BARCODE	SIZE	DEPTH	PK QTY
LSD845	5019788008455	2mm	12-20mm	25pcs
LSD498	5019788004983	2mm	12-20mm	100pcs

LEVELLING WEDGES



Use with levelling spacers for perfect tile to tile alignment.

CODE	BARCODE	SIZE	PK QTY
LSW846	5019788008462	98x22x20mm	25pcs
LSW851	5019788008516	98x22x20mm	100pcs
LSW895	5019788008950	98x22x20mm	250pcs

1MM SPACER AND WEDGE COMBINATION PACK



The Tile Rite Levelling Spacer System ensures that your large format Porcelain, Marble or Stone tiles are perfectly aligned and held level.

- ✓ Pack contains 25 spacers & 25 wedges.
- ✓ Ensures even 1mm grout lines.
- ✓ For wall & floor tiling.

CODE	BARCODE	SIZE	DEPTH	PK QTY
LSK849	5019788008493	1mm	2-12mm	25+25pcs

LEVELLING PLIERS

The Tile Rite Levelling Pliers offer the ideal amount of force when tightening our tile levelling wedges into the tile levelling spacers.

This specially designed tool makes it faster and easier to finish large jobs than doing this motion by hand.

- ✓ Use in conjunction with Tile Rite levelling tile spacers & wedges.
- ✓ More force with less effort.
- ✓ Assures tile surface alignment.
- ✓ Saves finger fatigue.



CODE	BARCODE	SIZE	BOX QTY
LSP848	5019788008486	ONE SIZE	6

LONG LEG TILE SPACER BAGS



CODE	BARCODE	SIZE	PK QTY
TSL053	5019788000534	1mm	500
TSL482	5019788004822	2mm	100
TSL483	5019788004839	2mm	250
TSL484	5019788004846	2mm	500
TSL485	5019788004853	3mm	100
TSL486	5019788004860	3mm	250
TSL487	5019788004877	3mm	500
TSL256	5019788002569	4mm	100
TSL257	5019788002576	4mm	250
TSL258	5019788002583	4mm	500
TSL488	5019788004884	5mm	100
TSL489	5019788004891	5mm	250

DID YOU KNOW?

The tile spacer was Tile Rite's first ever product back in 1989.

Did you know they can be left in place and grouted over.



Visit our website for more facts!

WWW.TILERITE.CO.UK

LONG LEG TILE SPACER BUCKETS

Tiles expand & contract even when fixed. If tiles were not spaced they would push against each other, crack and come loose.

Tile spacers make sure that your spaces are even and give a professional look to the finished installation. Spacer width is a personal preference however traditionally 2mm was used for walls and 3mm for floors.

- ✓ Long Leg tile spacers are the professionals preferred choice.
- ✓ The benefit of using long leg tile spacers are that they are easier to pick up and handle and you are less likely to loose them behind the tile.

CODE	BARCODE	SIZE	PK QTY
LLB706	5019788007069	1mm	2,000
LLB095	5019788000954	2mm	1500
LLB096	5019788000961	3mm	1500
LLB097	5019788000978	4mm	1200
LLB098	5019788000985	5mm	1200
LLB099	5019788000992	6mm	1200



MOSAIC BACKER

Mosaic Mesh Backer instantly makes mosaic tile sheets rigid and level making them easier to fix & eliminates lipping.

- ✓ Can be used to pack out your mosaics to match a thicker field tile.
- ✓ Self-adhesive, easy to apply, no hassle.
- ✓ Easy to cut with a knife, no loss of mosaic versatility.
- ✓ 300mm x 300mm, fits a standard mosaic sheet.
- ✓ Keeps mosaics evenly spaced, no need for spacers.
- ✓ 50 sheets displayed in a handy retail counter box.

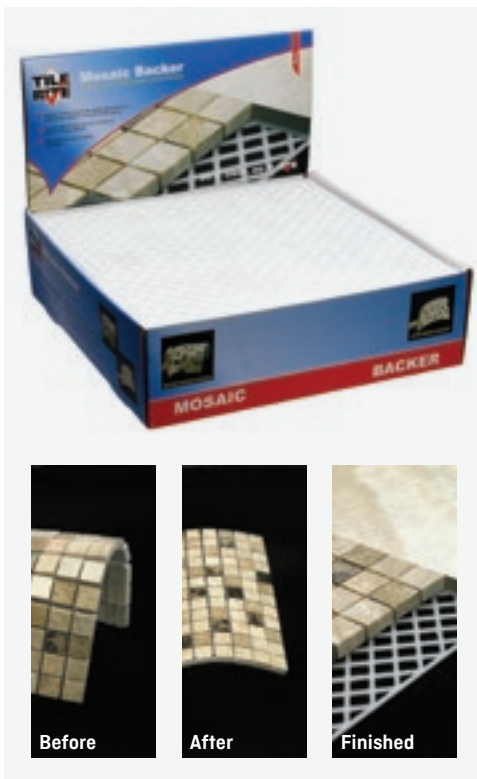

CODE	BARCODE	LENGTH	WIDTH	BOX QTY
MMB766	5019788007663	300mm	300mm	50sheets

T SPACERS



Tile Rite T Spacers are ideal for the even spacing of brick bond tile patterns and perimeter spacing.

- ✓ Suitable for use on walls & floors and ensures a professional look to the finished installation.
- ✓ Leave in and grout over or remove as desired.

CODE	BARCODE	SIZE	PK QTY
TSS214	5019788002149	2mm	250pcs
TSS215	5019788002156	3mm	250pcs
TSS216	5019788002163	5mm	250pcs

TILE SPACER WEDGES



Tile spacer wedges are used for wall tiling situations when you are putting bottom cuts in above any uneven surface like rough concrete etc.

- ✓ Spacer width from 1-5mm.
- ✓ Use stacked on top of each other for heights over 5mm.
- ✓ Great for marble wall tiling where each piece varies slightly and standard spacers will not work.
- ✓ Removable & reusable.

CODE	BARCODE	SIZE	PK QTY
TSW279	5019788002798	1-5mm	250pcs

TILE SPACER PEGS



Tile spacer pegs are used as an alternative to spacer crosses to evenly space out wall tiles for an even grout line.

- ✓ These tile spacer pegs are 2mm in diameter and have a hollow section.
- ✓ Spacer pegs must be removed before grouting.

CODE	BARCODE	SIZE	PK QTY
TSP519	5019788005195	2mm	1000pcs

FOR MORE INFORMATION OR TO ORDER
CALL US ON: 01543 500 893

LEVELLING SYSTEMS &
TILE SPACERS

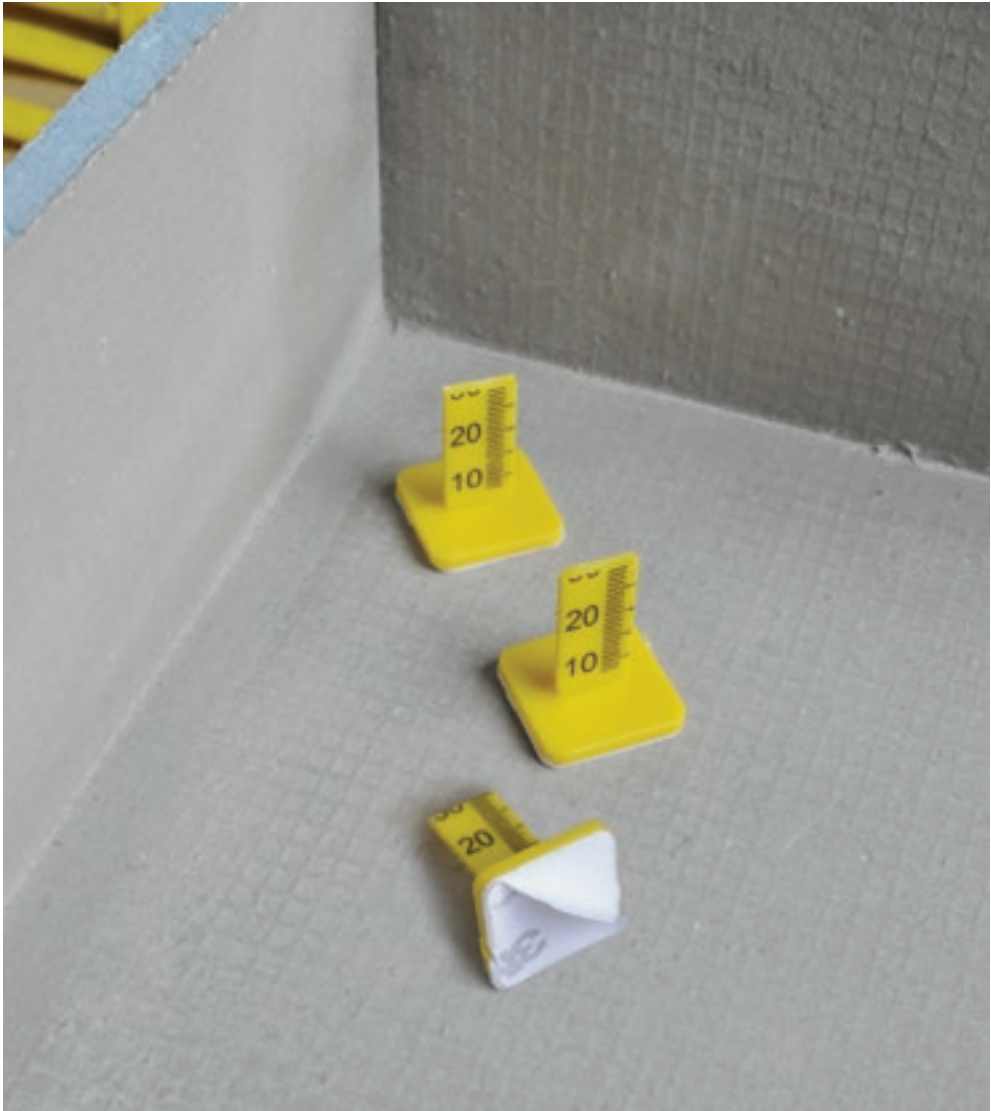

Plastic, self-adhesive height measurement pins for use with self levelling screed.

- ✓ Using these levelling pegs is a very time & cost effective way of building new subfloors or levelling old uneven floors.
- ✓ High adhesive strength. Engineered to stay straight up and locked in place during a pour.
- ✓ Easy to read 10-100 millimeter scale.
- ✓ No holes to drill.
- ✓ Bright yellow colour making them easily visible.



CODE	BARCODE	SCALE	DESCRIPTION	PACK SIZE
FLP887	5019788008875	10-100mm	floor levelling pegs	200 pcs

2MM TRADE TUB



10,000 2mm tile spacers in a handy 5 litre bucket. These tile spacers ensure your spaces are even and give a professional look to the finished installation.

- ✓ Spacer width is a personal preference however traditionally 2mm is used for walls.
- ✓ Leave in and grout over or remove as desired.

CODE	BARCODE	SIZE	PK QTY
STT052	5019788000527	2mm	10,000

2MM WALL TILE SPACERS

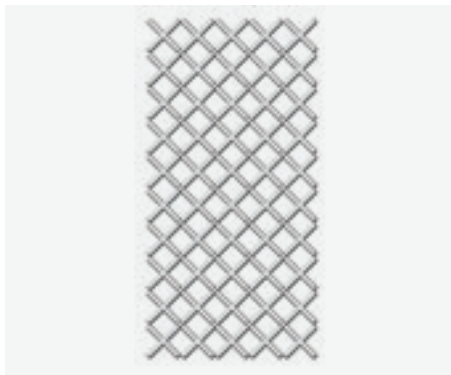

2mm solid wall tile spacer crosses joined together in sheets of 50pcs.

- ✓ Leave in and grout over or remove as desired.

CODE	BARCODE	SIZE	PK QTY
WTS506	5019788005065	2mm	100pcs
WTS507	5019788005072	2mm	500pcs
WTS514	5019788005140	2mm	1000pcs

3MM FLOOR TILE SPACERS



3mm solid floor tile spacer crosses joined together in sheets of 50pcs.

- ✓ Leave in and grout over or remove as desired.

CODE	BARCODE	SIZE	PK QTY
FTS512	5019788005126	3mm	100pcs
TTS134	5019788001340	3mm	250pcs

5MM FLOOR TILE SPACERS



5mm tile spacers are almost exclusively used on floor tiles.

- ✓ Ideal to use when laying natural stone tiles that vary in size where a larger grout line is required.
- ✓ These grey solid tile spacers can be left in place and grouted over or removed as desired.

CODE	BARCODE	SIZE	PK QTY
LTSS42	5019788005423	5mm	250pcs



FOR MORE INFORMATION OR TO ORDER
CALL US ON: 01543 500 893

DRILLS & HOLE SAWS

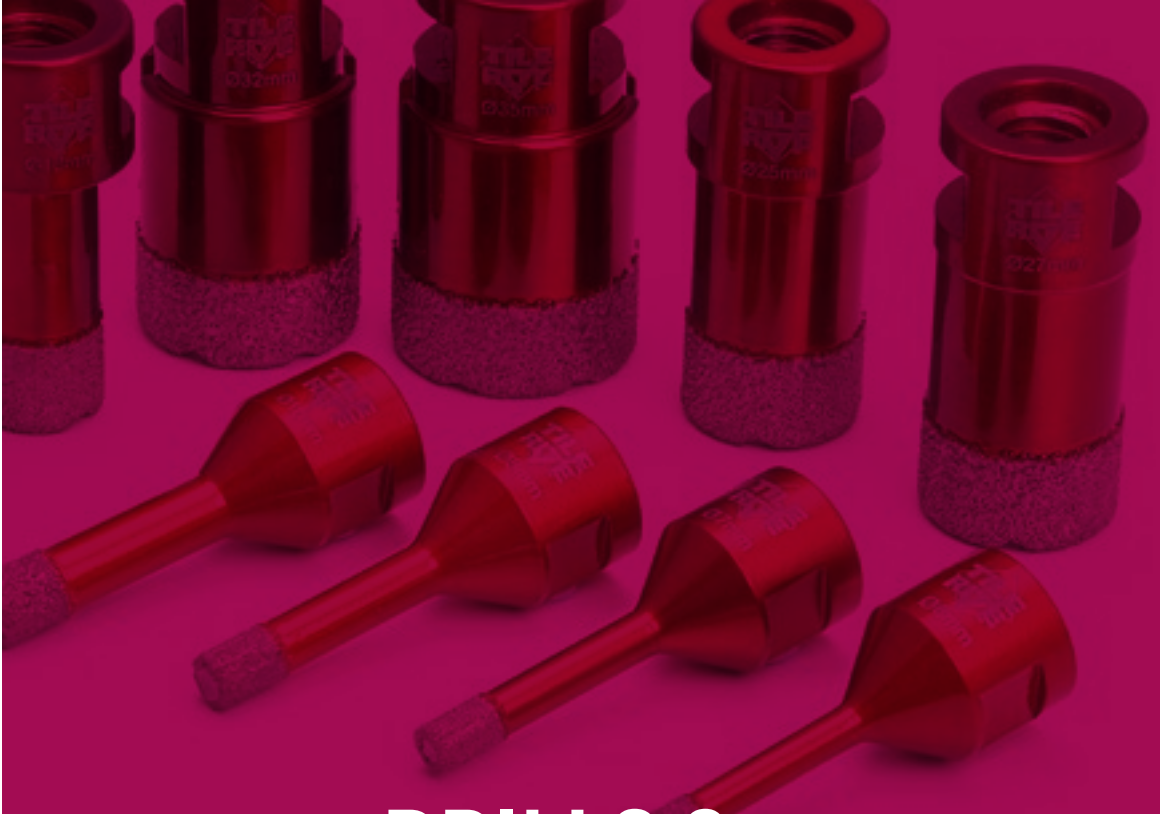

DRILLS & HOLE SAWS

WE STOCK A RANGE OF DRILL BITS THAT CAN EASILY PENETRATE PORCELAIN AND GLASS TILES IN WET OR DRY CONDITIONS.

Our traditional spade tip and non-slip tile drills are for use in dry conditions and are suitable for more traditional tile types such as Ceramic, Glass, Terracotta, Quarry & Slate. These drill bits are designed to fit into any standard drill chuck.

Diamond is the most effective material to cut harder tile types such as Porcelain, Marble Granite And Travertine. We supply a wide range of high quality Diamond tipped hole saws, for use in both wet & dry conditions to fit both standard chuck and M14 fittings.

In this section....

- ✓ M14 Dry cut diamond hole saws & accessories.
- ✓ Dry cut Diamond hole saws for use in any standard drill.
- ✓ Wet cut Diamond hole saws.
- ✓ Diamond drilling accessories.
- ✓ Non slip & traditional tile & glass drills.

NEW M14 DRY CUT DIAMOND HOLE SAWS



These super strong brazed diamond hole saws make drilling holes in Porcelain, Marble, Granite & Travertine tiles quick & easy.

- ✓ For best results use with the Tile Rite Angle Grinder (AGR260) at Max RPM 6000-11000.
- ✓ The M14 to 3-Jaw chuck adapter (CAD389) allows the use of Tile Rite M14 diamond drill bits to be used in any standard drill.



CODE	BARCODE	SIZE	PK QTY
MDRY727	5019788007274	6mm	1
MDRY875	5019788008752	7mm	1
MDRY755	5019788007557	8mm	1
MDRY756	5019788007564	10mm	1
MDRY770	5019788007700	18mm	1
MDRY902	5019788009025	20mm	1
MDRY772	5019788007724	25mm	1
MDRY876	5019788008769	27mm	1
MDRY777	5019788007779	32mm	1
MDRY778	5019788007786	35mm	1
MDRY903	5019788009032	45mm	1



FOR BEST RESULTS:



Use with Tile Rite Angle Grinder AGR260.



& Drill chuck adapter CAD389.



FOR MORE INFORMATION OR TO ORDER
CALL US ON: 01543 500 893

DRILLS & HOLE SAWS

10MM M14 BRAZED DIAMOND MILL



The 10mm brazed diamond mill is used for enlarging holes, making oval holes or other adjustments after drilling into porcelain, marble, granite & travertine wall & floor tiles and many other surfaces.

- ✓ For best results use with the Tile Rite angle grinder (AGR260) at max RPM 6000-11000.
- ✓ Grinding grain medium 50-60.

CODE	BARCODE	SIZE	PK QTY
DMM884	5019788008844	10mm	1

20MM M14 BRAZED DIAMOND MILL



The 20mm brazed diamond mill is used for enlarging holes, making oval holes or other adjustments after drilling into porcelain, marble, granite & travertine wall & floor tiles and many other surfaces.

- ✓ For best results use with the Tile Rite angle grinder (AGR260) at max RPM 6000-11000.
- ✓ Grinding grain medium 50-60.

CODE	BARCODE	SIZE	PK QTY
DMM885	5019788008851	20mm	1

M14 BRAZED DIAMOND MILL CONE



Used to enlarge, lower or even holes after drilling into porcelain, marble, granite & travertine wall & floor tiles & many other surfaces. Resists tension and cracking after drilling. Facilitates installation of cuffs.

- ✓ For best results use with the Tile Rite angle grinder (AGR260) at max RPM 6000-11000.
- ✓ Grinding grain medium 50-60.

CODE	BARCODE	SIZE	PK QTY
DMC886	5019788008868	2-38mm	1

M14 TO 3-JAW CHUCK ADAPTER



This M14 to 3-Jaw chuck adapter allows the use of Tile Rite brazed diamond drill bits to be used in any standard drill.

- ✓ Converts M14 thread dry drills for use in standard 3-jaw drill chucks.

CODE	BARCODE	SIZE	PK QTY
CAD389	5019788003894	ONE SIZE	1

DRY CUT DIAMOND HOLE SAWS



These super strong brazed diamond hole saws make drilling holes in porcelain, marble, granite & travertine tiles quick & easy.

- ✓ For dry drilling.
- ✓ Suitable for Porcelain.
- ✓ Hexagonal shank fits standard drill chucks.
- ✓ For best results use with an electric drill at 2000-3000rpm.
- ✓ Tile Rite recommend dipping the end of the drill bit in water to cool after each hole.



CODE	BARCODE	SIZE	PK QTY
DRY367	5019788003672	6mm	1
DRY368	5019788003689	8mm	1
DRY369	5019788003696	10mm	1
DRY375	5019788003757	18mm	1
DRY376	5019788003764	25mm	1
DRY377	5019788003771	35mm	1
DRY063	5019788000633	45mm	1



WET CUT DIAMOND HOLE SAWS

FOR MORE INFORMATION OR TO ORDER
CALL US ON: 01543 500 893

DRILLS & HOLE SAWS



Professional quality drills suitable for the wet drilling of porcelain, marble, granite & travertine tiles & many other surfaces.

- ✓ For wet drilling.
- ✓ Suitable for Porcelain.
- ✓ Use an electric drill.
- ✓ Max RPM 2000-3000.
- ✓ Straight shank fits all drill chucks.



CODE	BARCODE	SIZE	PK QTY
DDS234	5019788002347	6mm	1
DDB877	5019788008776	7mm	1
DDE235	5019788002354	8mm	1
DDT236	5019788002631	10mm	1
DDW290	5019788002903	12mm	1
DDA243	5019788002439	18mm	1
DDB244	5019788002446	25mm	1
DDB878	5019788008783	27mm	1
DDW462	5019788004624	32mm	1
DDC264	5019788002644	35mm	1
SWB070	5019788000701	38mm	1
DDD265	5019788002651	45mm	1
DDB261	5019788002613	50mm	1
SLB074	5019788000749	60mm	1
DDF705	5019788007052	83mm	1
SPB287	5019788002873	115mm	1

FOR BEST RESULTS:



Use with our Cooling System & Guide CSG262

DIAMOND DRILL BOX SET



Suitable for the wet drilling of porcelain, marble, granite & travertine tiles.

- ✓ This box set includes drill bit sizes 4,6,8,10 & 12mm.
- ✓ Electro plated diamond cutting rim.
- ✓ Straight shank fits all drill chucks.
- ✓ Use with Mini Guide & Cooling system.
- ✓ Discharge removal tool included.

CODE	BARCODE	SIZE
DBS270	5019788002705	4,6,8,10,12

DIY DIAMOND DRILL SET



This 14 piece set is ideal for the wet drilling of porcelain, marble, granite & travertine tiles.

- ✓ Set includes 5 x diamond drill bits in various sizes, 1 x cooling system bottle & 8 plastic drill guides with water feed.
- ✓ 1 x 0.9 Litre cooling system
- ✓ Drills included:
1x5mm / 2x6mm
1x8mm / 1x10mm.

CODE	BARCODE	SIZE
DDG069	5019788000695	5,6,8,10

COOLING SYSTEM & GUIDE



This kit includes a 1.1 Litre cooling system bottle & plastic universal drill guide with suction cup.

- ✓ The drill guide is adjustable for use with 6-83mm drill bits and has a water hose connection point to keep drill bits cool.
- ✓ The Cooling system bottle has a manual pump action with lockable water release button.

CODE	BARCODE	SIZE
CSG242	5019788002422	1.1Litre

1.1LTR COOLING SYSTEM



Easy to assemble 1.1 Litre water bottle for use with Tile Rite wet cut diamond drill bits & universal guides.

- ✓ Litre hand pressure sprayer.
- ✓ Lockable water release button.
- ✓ 105mm clear plastic hose.

CODE	BARCODE	SIZE
DCS237	5019788002378	1.1Litre

UNIVERSAL DRILL GUIDE



Plastic guide with suction cup for use with 6-83mm diamond drill bits.

- ✓ Suction cup to ensure non-slip when drilling.
- ✓ Hose attachment for use with cooling system bottle.

CODE	BARCODE	SIZE
PUG111	5019788001111	ONE SIZE

MINI UNIVERSAL DRILL GUIDE



Use the mini guide with suction cup to prevent drill bits slipping when drilling.

- ✓ Ideal for use with the diamond drill box set.
- ✓ Use with drill sizes 4,5,6,8,10,12 & 14mm.
- ✓ Hose attachment for use with cooling system bottle.

CODE	BARCODE	SIZE
MUG254	5019788002545	ONE SIZE



FOR MORE INFORMATION OR TO ORDER
CALL US ON: 01543 500 893

DRILLS & HOLE SAWS

NON SLIP TILE & GLASS DRILLS



Suitable for drilling Ceramic, Glass, Terracotta, Quarry, Slate Wall & Floor Tiles & many other surfaces.

- ✓ Tungsten carbide tipped to provide a longer working life.
- ✓ Requires no pilot hole or guide.
- ✓ Fits all standard drill chucks.

DID YOU KNOW?
THESE ARE
NON SLIP AND
REQUIRE NO GUIDE
OR PILOT HOLE.



CODE	BARCODE	SIZE
NSD871	5019788008714	5mm
NSD093	5019788000930	6mm
NSD872	5019788008721	7mm
NSD094	5019788000947	8mm
NSD873	5019788008738	10mm

TILE & GLASS DRILLS



Suitable for drilling Ceramic & Glass Tiles.

- ✓ Spade shaped tip.
- ✓ Fits all standard drill chucks.
- ✓ For ceramic & glass tiles only.



NEED HELP OR ADVISE ON WHICH DRILL IS BEST FOR YOU? JUST CALL US OR VISIT OUR SITE:

WWW.TILERITE.CO.UK

CODE	BARCODE	SIZE
TGD556	5019788005560	3mm
TGD557	5019788000558	4mm
TGD558	5019788005584	5mm
TGD509	5019788005096	6mm
TGD559	5019788005591	8mm
TGD560	5019788003948	10mm

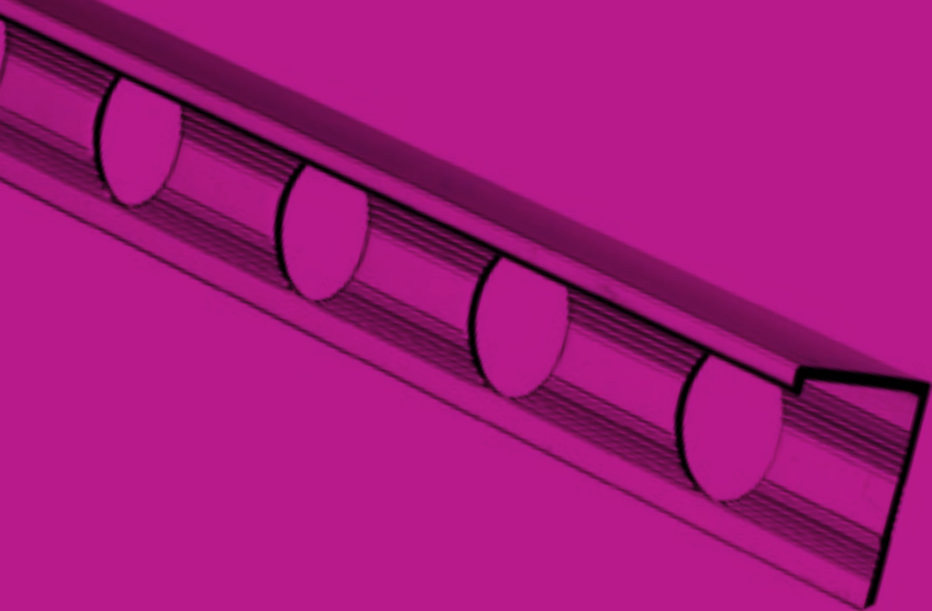

METAL TILE EDGE

**TILE TRIMS PROTECT AND DECORATE
TILED EXTERNAL CORNERS AND OTHER
UNGLAZED TILE EDGES PRONE TO DAMAGE.
WE OFFER A WIDE RANGE OF PROFILES
IN HIGH PERFORMANCE GRADE 6463-T6
ALUMINIUM OR G304 STAINLESS STEEL.**

Our 6463-T6 grade aluminium is low in iron and ideal for brightening & creating a lustrous finish. We anodise our trims to provide high corrosion resistance and an optimum seal to ensure years of wear and tear without milking or flaking occurring.

Our G304 stainless steel trims consist of 18% chromium & 8% nickel providing excellent resistance to corrosion & rust and are suitable for use in a wide range of atmospheric environments.

In this section

- ✓ Pro+ L Shape Tile Edge.
- ✓ Pro+ Quadrant Tile Edge.
- ✓ Square Edge & Triangular Tile Edge.
- ✓ Contemporary Range.
- ✓ Trade Trim.
- ✓ Cove Trim.
- ✓ Corner Guard.
- ✓ Feature Capping Trim.
- ✓ Listello Feature Trims.
- ✓ Glitter Listellos.
- ✓ G304 Stainless Steel Tile Edge.



PRO+ L SHAPE TILE EDGE



Tile Rite Profile Plus+ L Shape Tile Trim is made of high quality aluminium, this unique tile trim offers an attractive, professional finish to ceramic tile counters and walls.

Our unique 85° angled up-stand is the design feature that makes the Profile Plus+ anything but "standard". This important angle allows the grout to be dovetailed into the joint to eliminate grout cracking.



CODE	BARCODE	COLOUR	INT DEPTH	EXT DEPTH	LENGTH
MSL112	5019788001128	BRIGHT SILVER	8.2mm	9.2mm	2.44m
SSL388	5019788003887	S/STEEL EFFECT	8.2mm	9.2mm	2.44m
MML110	5019788001104	MATT SILVER	8.2mm	9.2mm	2.44m
BLS217	5017988002170	BRUSHED BLACK	8.2mm	9.2mm	2.44m
BNL830	5019788008301	BLACK NICKEL	8.2mm	9.2mm	2.44m
SLT227	5019788002279	BRIGHT SILVER	10mm	11mm	2.44m
SSL348	5019788003481	S/STEEL EFFECT	10mm	11mm	2.44m
LFT9015	5019788007281	MATT SILVER	10mm	11mm	2.44m
BLS218	5019788002187	BRUSHED BLACK	10mm	11mm	2.44m
BNL833	5019788008332	BLACK NICKEL	10mm	11mm	2.44m
TLS116	5019788001166	BRIGHT SILVER	12.3mm	13.3mm	2.44m
SSL349	5019788003498	S/STEEL EFFECT	12.3mm	13.3mm	2.44m
BLS219	5019788002194	BRUSHED BLACK	12.3mm	13.3mm	2.44m
BNL834	5019788008349	BLACK NICKEL	12.3mm	13.3mm	2.44m
FST239	5019788002392	BRIGHT SILVER	14mm	15mm	2.44m
SSL351	5019788003511	S/STEEL EFFECT	14mm	15mm	2.44m
MLG241	5019788002415	MATT GOLD	14mm	15mm	2.44m
BLS245	5049788002453	BRUSHED BLACK	14mm	15mm	2.44m
BNL835	5019788008356	BLACK NICKEL	14mm	15mm	2.44m

Actual Size

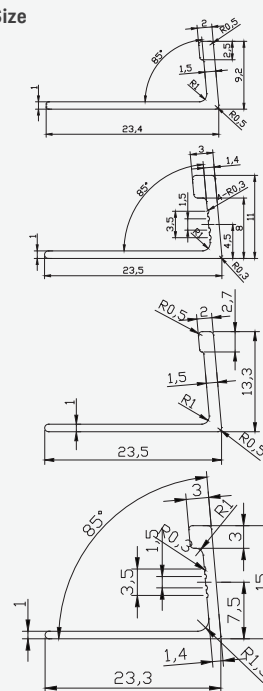

FOR MORE INFORMATION OR TO ORDER
CALL US ON: 01543 500 893

METAL TILE EDGE

PRO+ QUADRANT TILE EDGE



Tile Rite Profile Plus+ Quadrant Tile Trim is made of high quality aluminium, this unique tile trim offers an attractive, professional finish to tiled external corners and other tiled edges prone to damage.

Our unique Impact Absorption Zone is the design feature that makes the Profile Plus+ anything but "standard". This important zone allows the edge strip to absorb impacts without the grout cracking or tiles chipping.

- ✓ Made with 6463-T6 aluminium.
- ✓ 2.44m Lengths.

Complimentary products

These profiles have specifically designed external corner pieces to provide a perfect 2 or 3-way join where profiles meet.

- ✓ 2 per pack.



Actual Size

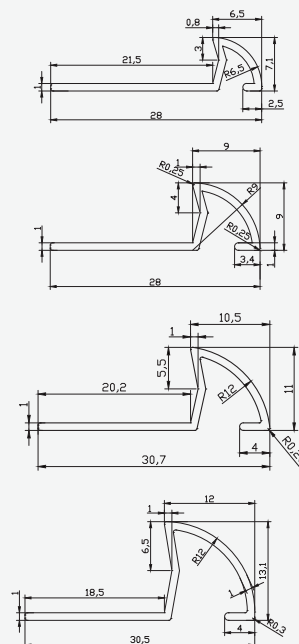

CODE	BARCODE	COLOUR	INT DEPTH	EXT DEPTH	CORNER
STS223	5019788002231	BRIGHT SILVER	6.1mm	7.1mm	X
STC222	5019788002224	BRIGHT GOLD	6.1mm	7.1mm	X
TES557	5019788005577	BRIGHT SILVER	8mm	9mm	SSC152
MAT302	5019788003023	MATT SILVER	8mm	9mm	MSC305
RSS373	5019788003733	S/STEEL EFFECT	8mm	9mm	SSEC380
TMS250	5019788002507	BRIGHT SILVER	10mm	11mm	SMC248
MAT303	5019788003030	MATT SILVER	10mm	11mm	MSC306
RSS379	5019788003795	S/STEEL EFFECT	10mm	11mm	SSEC381
BNR839	5019788008394	BLACK NICKEL	10mm	11mm	X
TES628	5019788007137	BRIGHT SILVER	12.1mm	13.1mm	SDC155
RSS387	5019788003870	S/STEEL EFFECT	12.1mm	13.1mm	X
TEG628	5019788007106	BRIGHT GOLD	12.1mm	13.1mm	SSEC385
BNR840	5019788008400	BLACK NICKEL	12.1mm	13.1mm	X



FOR MORE INFORMATION OR TO ORDER
CALL US ON: 01543 500 893

METAL TILE EDGE

SQUARE EDGE TILE TRIM

This tile trim is made of high quality 6463-T6 aluminium, this unique tile trim offers an attractive, professional finish to ceramic tile counters and walls.

Tile Rite Square Edge Tile Trim is tough and durable and is designed to protect and decorate tiled outer wall corners and other tiled edges prone to damage.



**NEED HELP OR
ADVISE ON WHICH
TRIM IS BEST FOR
YOU? JUST CALL
US OR VISIT OUR
WEBSITE:**

WWW.TILERITE.CO.UK



CODE	BARCODE	COLOUR	SIZE	DEPTH
SES352	5019788003528	BRIGHT SILVER	9.56mm	2.44m
SES353	5019788003535	S/STEEL EFFECT	9.56mm	2.44m

Actual Size

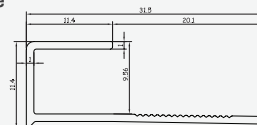

TRIANGULAR TILE TRIM

Tile Rite Triangular Tile Trim is made of high quality 6463-T6 aluminium. This unique & stylish tile trim offers an attractive finish to ceramic tile counters and walls.

Tile Rite Triangular Trim is tough & durable and is designed to protect and decorate tiled outer wall corners and other tiled edges prone to damage.

Available in 10mm & 12mm depths and finishes of Bright Silver & Stainless-Steel Effect.

- ✓ Made with 6463-T6 aluminium.
- ✓ 2.44m Lengths.
- ✓ Pack qty 10.



Complimentary Products

These profiles have specifically designed internal & external corner pieces to provide a perfect safe edge where profiles meet.

- ✓ 2 corners per pack.



CODE	BARCODE	COLOUR	INT DEPTH	INT CORNER	EXT CORNER
TRI858	5019788008585	BRIGHT SILVER	10mm	TRI1863	TRIE862
TRI860	5019788008608	S/STEEL EFFECT	10mm	TRI1868	TRIE867
TRI859	5019788008592	BRIGHT SILVER	12mm	TRI1865	TRIE864
TRI861	5019788008615	S/STEEL EFFECT	12mm	TRI1870	TRIE869

Size Guide

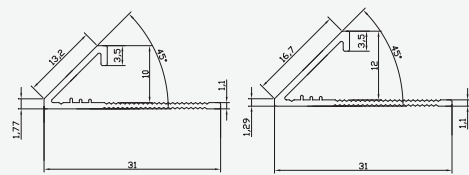

CONTEMPORARY RANGE



The new Tile Rite contemporary range. Affordable, fashionable tile edging.

Tile Rite L shape contemporary range trims are easy to mitre, making them versatile enough to create features such as; surrounding a window frame, part tiled walls, external corners and surrounding a splash back.

Brushed copper and Brushed gold:

- ✓ E-coated.
- ✓ Antique finish.
- ✓ 2.44m Lengths.
- ✓ Available in 10mm and 12mm.



Cast Iron:

- ✓ Powder coated.
- ✓ Industrial metal finish.
- ✓ 2.44m Lengths.
- ✓ Available in 10mm and 12mm.



Brushed Copper



Brushed Gold



Cast Iron

CODE	BARCODE	COLOUR	FINISH	A	B	C	D
CLT896	5019788008967	BRUSHED COPPER	E-COATED	10mm	2.2mm	10mm	18mm
CLT897	5019788008974	BRUSHED COPPER	E-COATED	12mm	2.2mm	13mm	18mm
GLT911	5019788009117	BRUSHED GOLD	E-COATED	10mm	2.2mm	10mm	18mm
GLT912	5019788009124	BRUSHED GOLD	E-COATED	12mm	2.2mm	13mm	18mm
IRO898	5019788008981	CAST IRON	POWDER COATED	10mm	2.2mm	10mm	18mm
IRO899	5019788008998	CAST IRON	POWDER COATED	12mm	2.2mm	13mm	18mm

Size Guide

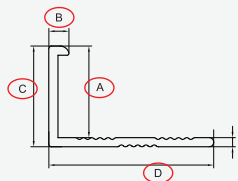

L SHAPE TRADE TRIM

Use to protect & enhance tiled external corners & unglazed tile edges prone to damage.

- ✓ Made with 6463-T6 aluminium.
- ✓ 2.44m Lengths.



CODE	BARCODE	COLOUR	A	B	C	D
ELT346	5019788003467	BRIGHT SILVER	6mm	2.2mm	7mm	18mm
ELT085	5019788000855	BRIGHT SILVER	8mm	2.2mm	9mm	18mm
ELT086	5019788000862	BRIGHT SILVER	10mm	2.2mm	10mm	18mm
ELT087	5019788000879	BRIGHT SILVER	12mm	2.2mm	13mm	18mm
ELT108	5019788001081	BRIGHT SILVER	15mm	2.2mm	16mm <td 18mm	
ELT090	5019788000909	SATIN SILVER	12mm	2.2mm	13mm	18mm
ELT109	5019788001098	SATIN SILVER	15mm	2.2mm	16mm	18mm
ELT347	5019788003474	S/STEEL EFFECT	6mm	2.2mm	7mm	18mm
ELS429	5019788003931	S/STEEL EFFECT	8mm	2.2mm	9mm	18mm
ELS430	5019788004303	S/STEEL EFFECT	10mm	2.2mm	11mm	18mm
ELS431	5019788004310	S/STEEL EFFECT	12mm	2.2mm	13mm	18mm
ELS432	5019788004327	S/STEEL EFFECT	15mm	2.2mm	16mm	18mm

Size Guide

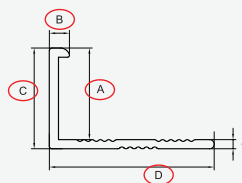

QUADRANT TRADE TRIM

Use to protect & enhance tiled external wall corners & unglazed tile edges prone to damage.

- ✓ Made with 6463-T6 aluminium.
- ✓ 2.44m Lengths.



CODE	BARCODE	COLOUR	A	B	C	D
EQT102	5019788001029	BRIGHT SILVER	6.2mm	7.8mm	8mm	25.8mm
EQT103	5019788001036	BRIGHT SILVER	8.2mm	7.5mm	10mm	25.8mm
EQT104	5019788001043	BRIGHT SILVER	10.2mm	7.6mm	12mm	25.8mm
ESS393	5019788009391	BRIGHT SILVER	12.2mm	7.6mm	14mm	25.8mm
EQT105	5019788001050	BRIGHT SILVER	6.2mm	7.8mm	8mm	25.8mm
EQT106	5019788001067	SATIN SILVER	8.2mm	7.5mm	10mm	25.8mm
EQT107	5019788001074	SATIN SILVER	10.2mm	7.6mm	12mm	25.8mm
ESS390	5019788003900	S/STEEL EFFECT	8.2mm	7.5mm	10mm	25.8mm
ESS391	5019788003917	S/STEEL EFFECT	10.2mm	7.6mm	12mm	25.8mm
ESS392	5019788003924	S/STEEL EFFECT	12.2mm	7.6mm	14mm	25.8mm

Size Guide

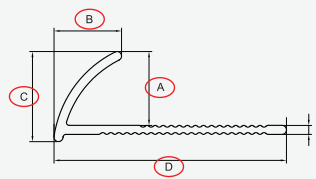

SILVER COVE TRIM

Tile Rite Cove Trim is designed for use on internal wall corners, kitchen countertops or at skirting level to provide a neat transition.

- ✓ Creates a neat transition from worktop to tiled wall.
- ✓ Can also be used for the perfect skirting between walls & floors.
- ✓ Suitable for internal wall corners.



Bright Silver



Actual Size

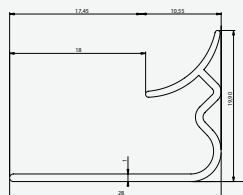

TILING TIP:

You can also apply a small bead of silicone underneath and behind the front face of the profile before fixing your tiles to provide a seal if there is no anticipated movement.



CODE	BARCODE	COLOUR	INT DEPTH	LENGTH	LENGTH
SCT298	5019788002989	BRIGHT SILVER	9.82mm	2.44m	900mm

CORNER GUARD

Tile Rite Corner Guards are designed to absorb and protect against impact damage on External Tiled Corners and other edges subjected to lots of wear and tear.

Suitable for retro fixing, these profiles provide a decorative and clean finish as well as covering existing damage to walls.

Made with 6463-T6 aluminium, install with builder's adhesive or builder's heavy duty double sided tape.

- ✓ Available in polished bright silver or brushed stainless steel finish.
- ✓ Pack Qty: 10.
- ✓ 2.44m Lengths.

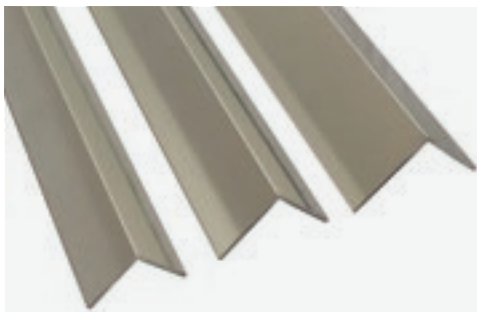

Stainless Steel



Bright Silver



Size Guide

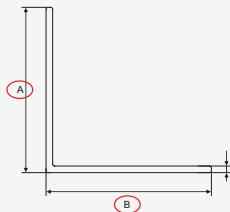

CODE	BARCODE	FINISH	A	B	LENGTH
SCG690	5019788006901	BRIGHT SILVER	20mm	20mm	3m
SCG691	5019788006918	BRIGHT SILVER	25mm	25mm	3m
SCG692	5019788006925	BRIGHT SILVER	30mm	30mm	3m
BSCG693	5019788006932	S/STEEL EFFECT	20mm	20mm	3m
BSCG694	5019788006949	S/STEEL EFFECT	25mm	25mm	3m
BSCG695	5019788006956	S/STEEL EFFECT	30mm	30mm	3m



FOR MORE INFORMATION OR TO ORDER
CALL US ON: 01543 500 893

METAL TILE EDGE

10MM FEATURE CAPPING TRIM



Stainless Steel



Bright Silver

Size Guide

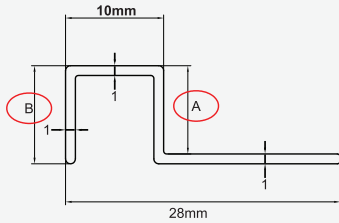

Tile Rite Feature Capping Trim is a protective profile with a 10mm* visible surface for decorative joint design in tiled surfaces and is also ideal for finishing the perimeters of tiled surfaces or for transitions to different types of coverings.

Tile Rite Feature Capping Trim also provides protection against mechanical damage around tile edges.

- ✓ Available in 9mm, 11mm & 12.8mm internal depths and finishes of Bright Silver & Stainless-Steel Effect.
- ✓ Pack qty 10.

CODE	BARCODE	COLOUR	SIZE	A	B	LENGTH
FCT426	5019788004266	BRIGHT SILVER	10mm	9mm	10mm	2.44m
FCT866	5019788008660	BRIGHT SILVER	10mm	11mm	12mm	2.44m
FCT372	5019788003726	BRIGHT SILVER	10mm	12.8mm	14mm	2.44m
SSEF842	5019788008424	S/STEEL EFFECT	10mm	9mm	10mm	2.44m
SSEF852	5019788008523	S/STEEL EFFECT	10mm	11mm	12mm	2.44m

15MM FEATURE CAPPING TRIM



Stainless Steel



Bright Silver

Size Guide

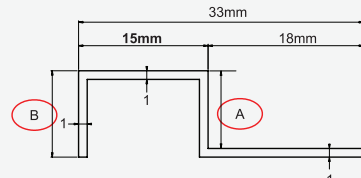

Tile Rite Feature Capping Trim is a protective profile with a 15mm* visible surface for decorative joint design in tiled surfaces and is also ideal for finishing the perimeters of tiled surfaces or for transitions to different types of coverings.

Tile Rite Feature Capping Trim also provides protection against mechanical damage around tile edges.

- ✓ Available in 9mm & 11mm internal depths and finishes of Bright Silver.
- ✓ Pack qty 10.

CODE	BARCODE	COLOUR	SIZE	A	B	LENGTH
FCT051	5019788000510	BRIGHT SILVER	15mm	9mm	10mm	2.44m
FCT345	5019788003450	BRIGHT SILVER	15mm	11mm	12mm	2.44m

BOX LISTELLOS

10MM



20MM

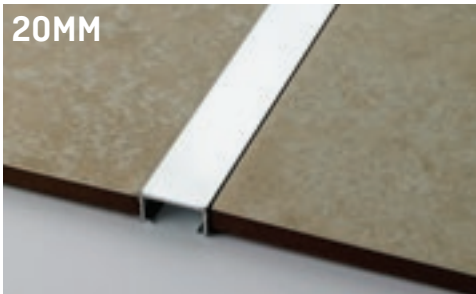

30MM



Tile Rite box Listellos are decorative feature trims developed for visual wall design.

Listellos can be used between tiles horizontally or vertically, to create visual interest.

- ✓ Available with a 10mm, 20mm or 30mm visible surface and in 7mm & 10mm depths.
- ✓ Made with 6463-T6 aluminium.
- ✓ 2.44m Lengths.

Black Nickel



Bright Silver



S/Steel Effect



**WANT TO KNOW
MORE ABOUT THIS?
CALL US
TODAY ON:
01543 500 893**



CODE	BARCODE	COLOUR	SIZE	DEPTH	LENGTH
TSF269	5019788002699	BRIGHT SILVER	10mm	7mm	2.44m
TSF433	5019788004334	S/STEEL EFFECT	10mm	7mm	2.44m
TSF836	5019788008363	BLACK NICKEL	10mm	7mm	2.44m
BFS370	5019788003702	BRIGHT SILVER	10mm	10mm	2.44m
BFS434	5019788004341	S/STEEL EFFECT	10mm	10mm	2.44m
BFS837	5019788008370	BLACK NICKEL	10mm	10mm	2.44m
NLS371	5019788003719	BRIGHT SILVER	20mm	10mm	2.44m
NLS838	5019788008387	BLACK NICKEL	20mm	10mm	2.44m
NLS697	5019788006970	BRIGHT SILVER	30mm	10mm	2.44m
BLS698	5019788006987	S/STEEL EFFECT	30mm	10mm	2.44m

Actual Size

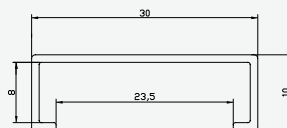
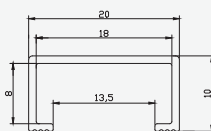
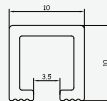
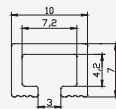

BRIDGE SHAPED LISTELLOS

These anodised aluminium Listello profiles were developed for visual wall design.

The Listello profiles provide individual aesthetic improvements to tiled areas. Can be used horizontally or vertically within your tiling.

Available in 10mm & 30mm widths and finishes of bright silver and bright gold.

- ✓ Made with 6463-T6 aluminium.
- ✓ 2.44m Lengths.
- ✓ Pack Qty 10.



Size Guide 10mm

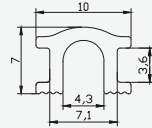

Size Guide 30mm

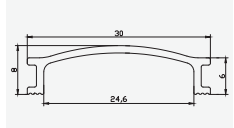

CODE	BARCODE	COLOUR	SIZE	DEPTH	LENGTH
SL621	5019788006215	BRIGHT SILVER	10mm	4mm	2.44m
GL551	5019788005515	BRIGHT GOLD	10mm	4mm	2.44m
SL552	5019788005522	BRIGHT SILVER	30mm	6mm	2.44m

SILVER DOMED LISTELLO

This anodised aluminium Listello profile was developed for visual wall design. The Listello provides individual aesthetic improvements to tiled areas. Can be used horizontally or vertically within your tiling.

- ✓ Made with 6463-T6 aluminium.
- ✓ 2.44m Lengths.
- ✓ Pack Qty 10.



**GET FREE DELIVERY
ON ALL ORDERS
OVER £150
NETT**

(UK MAINLAND ONLY)



Actual Size

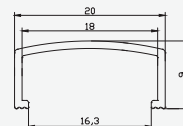

Bright Silver



CODE	BARCODE	COLOUR	SIZE	DEPTH
MLS228	5019788002286	BRIGHT SILVER	8mm	2.44m

GLITTER LISTELLO

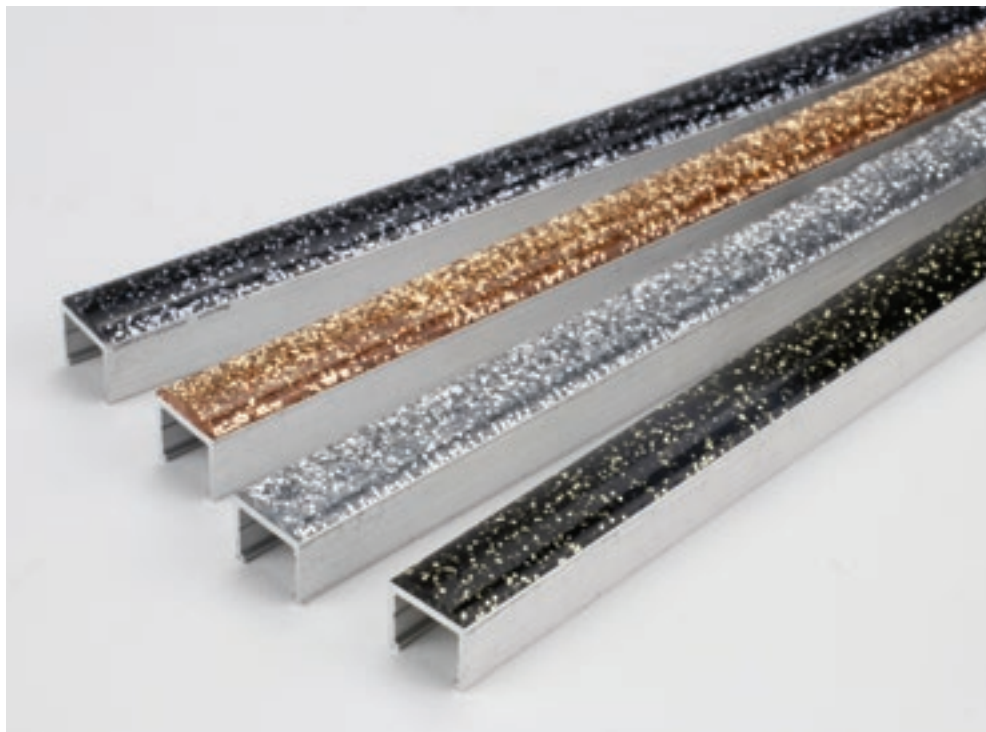

The New Tile Rite Glitter Listellos are part of the contemporary range; Affordable, fashionable tile edging.

Tile Rite box Listellos are decorative feature trims developed for visual wall design.

Listellos can be used between tiles horizontally or vertically, to create visual interest.

- ✓ Made with 6463-T6 aluminium.
- ✓ 2.44m Lengths.



Silver
Glitter



Gold
Glitter



Grey
Glitter



Black
Glitter



Actual Size:

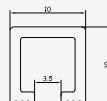

CODE	BARCODE	COLOUR	WIDTH	DEPTH	LENGTH
SGL906	5019788009063	SILVER	10mm	10mm	2.44m
GGL907	5019788009070	GOLD	10mm	10mm	2.44m
GRL908	5019788009087	GREY	10mm	10mm	2.44m
BGL909	5019788009094	BLACK	10mm	10mm	2.44m



G304 STAINLESS STEEL TRIMS

Made with G304 Stainless Steel, the most versatile & widely used grade which performs excellently in a wide range of atmospheric environments.

Use to protect & enhance tiled external corners & unglazed tile edges prone to damage.

Available in 3 profiles; L-shape, Quadrant & Box section, and has a polished bright silver finish.

- ✓ Made with Grade 304 Stainless Steel
- ✓ Polished bright silver finish
- ✓ Pack Qty: 10

FOR MORE INFORMATION OR TO ORDER
CALL US ON: 01543 500 893

METAL TILE EDGE

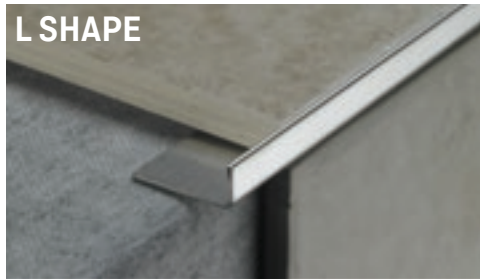

L SHAPE

Size Guide

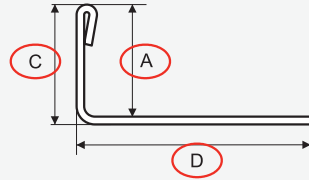

CODE	BARCODE	FINISH	PROFILE	A	C	D
SLS077	5019788000770	BRIGHT SILVER	L SHAPE	8mm	8.8mm	26mm
SLS078	5019788000787	BRIGHT SILVER	L SHAPE	10mm	10.8mm	26mm
SLS079	5019788000794	BRIGHT SILVER	L SHAPE	12.5mm	13.3mm	26mm



QUADRANT

Size Guide

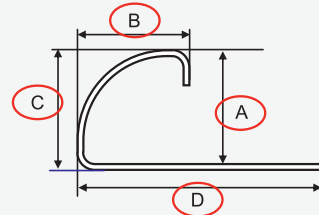

CODE	BARCODE	FINISH	PROFILE	A	B	C	D
SR5499	5049788004990	BRIGHT SILVER	QUADRANT	8.4mm	9mm	9.2mm	22.9mm
SR5500	5019788005003	BRIGHT SILVER	QUADRANT	10.2mm	10.2mm	11mm	26mm
SR5520	5019788005201	BRIGHT SILVER	QUADRANT	12.5mm	12.5mm	13.3mm	27mm



BOX SECTION

Size Guide

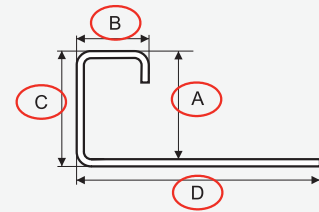

CODE	BARCODE	FINISH	PROFILE	A	B	C	D
SBS080	5019788000800	BRIGHT SILVER	BOX SECTION	8mm	8mm	8.8mm	27mm
SBS081	5019788000817	BRIGHT SILVER	BOX SECTION	10mm	10mm	10.8mm	27mm
SBS082	5019788000824	BRIGHT SILVER	BOX SECTION	12mm	12mm	12.8mm	27mm

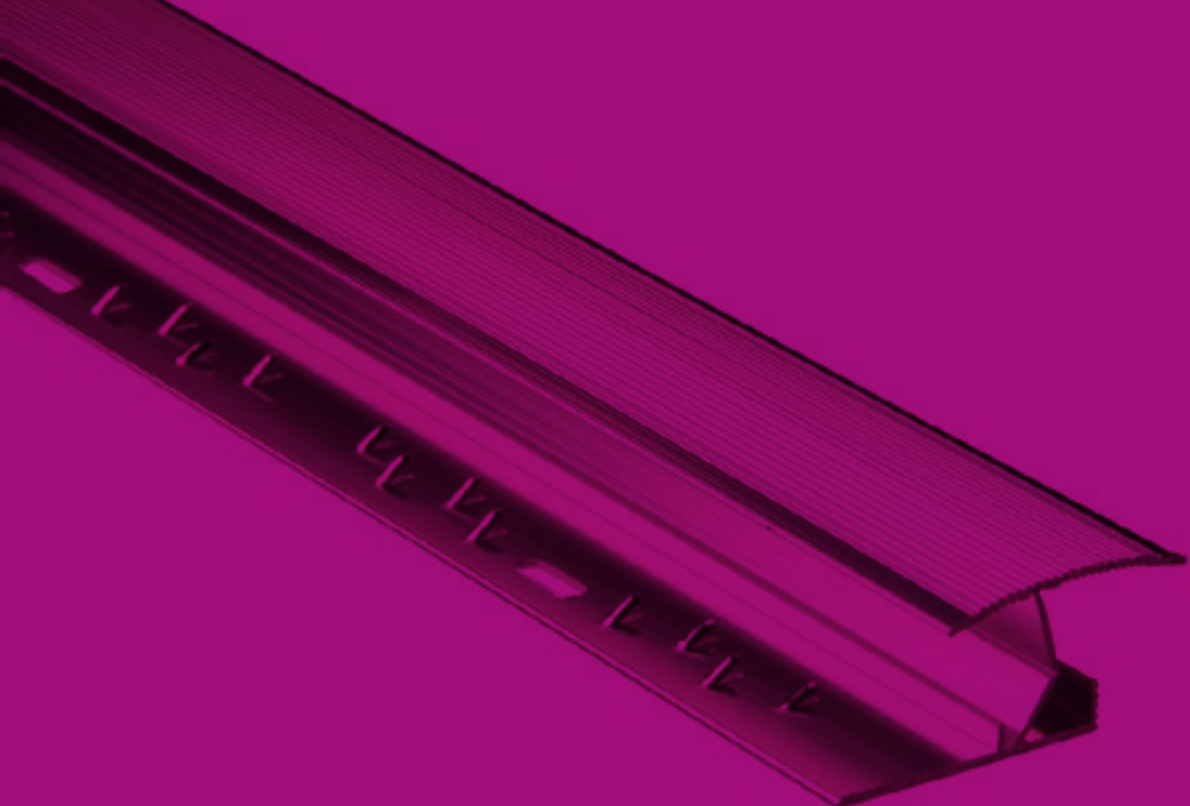

FLOOR TRIM

TILE RITE OFFER A RANGE OF FLOOR TRIMS IDEAL FOR USE AT DOOR THRESHOLDS.

These trims bridge any gaps and create a smooth transition between two flooring types.

We also offer a small selection of intermediate expansion joints. Expansion (or movement joints) must be installed in large tiled areas to prevent grout from cracking and tiles from tenting and becoming de-bonded from the substrate.

In this section

- ✓ Doorway Trims.
- ✓ Expansion Joints.

CARPET TO TILE TRIM

A screw down anodised aluminium door threshold trim that provides a clean bridge from carpet to tile.

- ✓ Anodised top screws in to an aluminium base plate with carpet grippers.
- ✓ Height adjustment from 5-12mm.
- ✓ Available in Bright Gold and Silver finishes.



**GET FREE DELIVERY
ON ALL ORDERS
OVER £150
NETT**

(UK MAINLAND ONLY)



CODE	BARCODE	FINISH	WIDTH	DEPTH	LENGTH
CTTG622	5019788006222	BRIGHT GOLD	27.8mm	5-12mm	0.864m
CTTG625	5019788006253	BRIGHT GOLD	27.8mm	5-12mm	2.6m
CTTS623	5019788006239	BRIGHT SILVER	27.8mm	5-12mm	0.864m
CTTS626	5019788006260	BRIGHT SILVER	27.8mm	5-12mm	2.6m

Actual Size

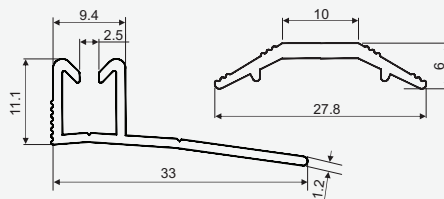

THRESHOLD STRIP

Anodised aluminium floor profile suitable for joining carpet to tiles at door thresholds.

- ✓ Z shaped profile with carpet grippers.
- ✓ Taps down to bridge the gap between carpet and tiles.
- ✓ 0.91m Lengths.



**NEED HELP OR
ADVISE ON WHICH
IS BEST FOR YOU?
JUST CALL US OR
VISIT OUR SITE:**

WWW.TILERITE.CO.UK

CODE	BARCODE	FINISH	WIDTH	DEPTH	LENGTH
THRC471	5019788004716	BRIGHT GOLD	27.9mm	5-12mm	0.91m
THRS470	5019788004709	BRIGHT SILVER	27.9mm	5-12mm	0.91m

Actual Size

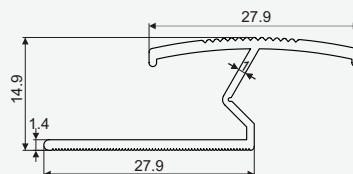

DOORWAY STRIPS



This Tile Rite Doorway Strip is used to join 2 different flooring types at door thresholds.

Suitable for joining tiles to; tiles, hardwood, laminate wood, & carpet. Also suitable for joining laminate to laminate. Comes with 2 sets of clips (small & medium) that allows variable height adjustment up to 15mm.

Suitable for joining tiles to; tiles, hardwood, laminate wood and carpet.

- ✓ Variable height adjustment up to 15mm.
- ✓ Allows for expansion.
- ✓ Easily fitted.

Bright Silver



Bright Gold

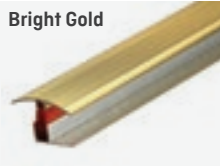

TOP TIP THIS IS HOW TO FIT DOORWAY STRIPS

Leave a 10mm expansion gap either side of the base plate.

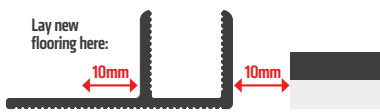

Select the appropriate clip size for the job (red/yellow), this will depend on the thickness of the floor.

Ensure pips are on the side of lowest floor height.



Complete system

CODE	BARCODE	FINISH	DEPTH	WIDTH	LENGTH
DSC262	5019788002620	BRIGHT GOLD	<15mm	35mm	900mm
DSS263	5019788002637	BRIGHT SILVER	<15mm	35mm	900mm
LDSC764	5019788007649	BRIGHT GOLD	<15mm	35mm	2600mm
LDSS763	5019788007632	BRIGHT SILVER	<15mm	35mm	2600mm

Replacement tops

CODE	BARCODE	FINISH	WIDTH	LENGTH
DTG816	5091788008165	BRIGHT GOLD	35mm	900mm
DTS812	5019788008127	BRIGHT SILVER	35mm	900mm

Actual Size

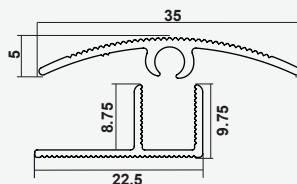

FOR MORE INFORMATION OR TO ORDER
CALL US ON: 01543 500 893

FLOOR TRIMS

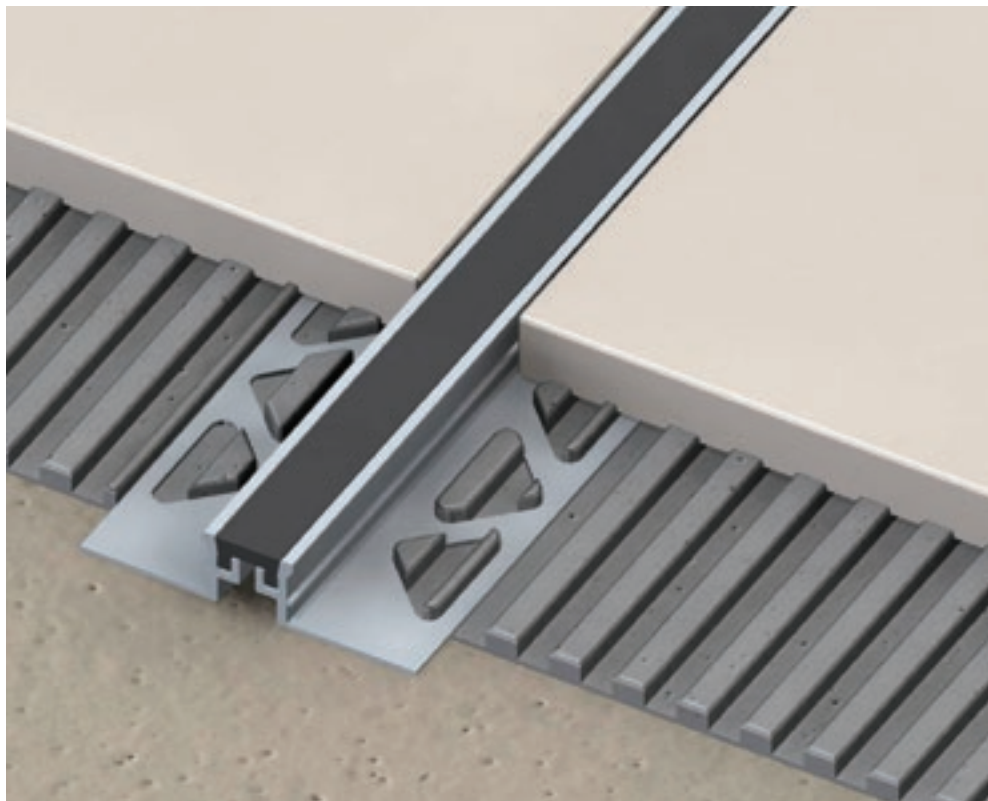

Movement joints must be installed in certain areas and positions to prevent tiles or grout from cracking... and in some cases prevent the tiles from tenting and becoming de-bonded from the substrate.

They are needed because all tiles expand and contract with temperature and moisture changes. In almost every case the substrate will move differently to the covering material.

- ✓ Intermediate movement joints for use in large tiled floors.
- ✓ Anchoring Legs - Aluminium 6063 T5.
- ✓ Flexible grey infill - EPDM with a shore hardness of 65.
- ✓ Infill removable & replaceable.
- ✓ Ability to absorb movement exceeds 20%.
- ✓ 2.5m Lengths.

BS5385. For a large tiled area with a dimension greater than 10m between perimeter joints, intermediate joints should be used to divide the floor into fields no greater than 10 x 10m. Each field should be kept as square as possible and sides should not exceed a size ratio of 2:1.

Actual Size

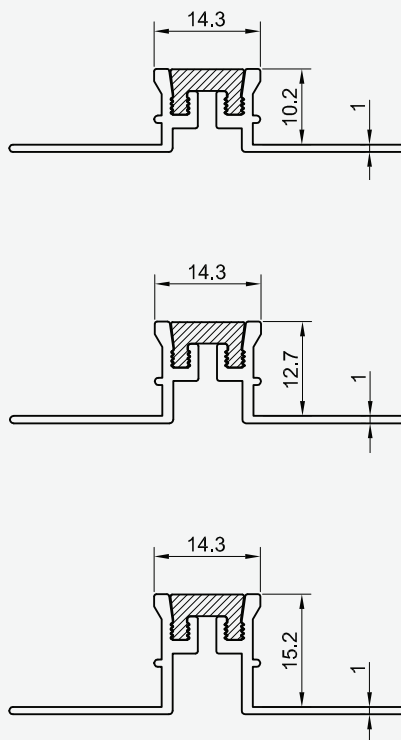

CODE	BARCODE	COLOUR	DEPTH	WIDTH	LENGTH
EJG049	5019788000497	GREY	10.2mm	14.3mm	2.5m
EJG065	5019788000657	GREY	12.7mm	14.3mm	2.5m
EJG067	5019788000671	GREY	15.2mm	14.3mm	2.5m



PVC TILE EDGE

**OUR PVC TILE EDGE IS
DESIGNED TO PROTECT
AND DECORATE RAW
TILE EDGES PRONE
TO DAMAGE.**

Available in a wide range of colours to compliment your tiles, this tile edge is versatile, has excellent chemical resistance, and requires no special maintenance.

All of our PVC trims are calcium zinc stabilized and contain no lead or substances of high concern and are suitable for indoor use.

Within this section

- ✓ Pro+ L Shape Trim.
- ✓ Pro+ Quadrant Trim.
- ✓ Ultrashine L Shape Trim.
- ✓ Ultrashine Quadrant Trim.
- ✓ Pro+ Plus Rope Trim.
- ✓ Trade Trim.
- ✓ PVC Corner Guard.
- ✓ Vinyl To Tile Capping.



PRO+ L SHAPE TILE EDGE



Tile Rite Profile Plus+ L Shape Tile Edge is designed to protect and decorate tiled external corners and other tiled edges prone to damage.

PVC is suitable for a wide range of applications due to its excellent chemical resistance and requires no special maintenance. Clean periodically using a PH neutral detergent to maintain the appearance.

The raw material used in the manufacture of our PVC products is calcium zinc stabilized and contains no lead or substances of high concern. Suitable for indoor use.

Slate Grey



Black



Soft Peach



White



Grey



American Bone



CODE	BARCODE	COLOUR	INT DEPTH	LENGTH
FTE472	5019788004723	WHITE	8.7mm	2.44m
FTE473	5019788004730	SOFT PEACH	8.7mm	2.44m
FTE474	5019788004747	AMERICAN BONE	8.7mm	2.44m
FTE341	5019788003412	GREY	8.7mm	2.44m
FTE475	5019788004754	BLACK	8.7mm	2.44m
FTE892	5019788008929	SLATE GREY	8.7mm	2.44m
FTE560	5019788005607	WHITE	10.6mm	2.44m
FTE561	5019788005614	SOFT PEACH	10.6mm	2.44m
FTE334	5019788003344	AMERICAN BONE	10.6mm	2.44m
FTE343	5019788003436	GREY	10.6mm	2.44m
FTE701	5019788007014	BLACK	10.6mm	2.44m
FTE893	5019788008936	SLATE GREY	10.6mm	2.44m
FTE114	5019788001142	WHITE	12mm	2.44m
FTE115	5019788001159	SOFT PEACH	12mm	2.44m
FTE335	5019788003351	AMERICAN BONE	12mm	2.44m
FTE344	5019788003443	GREY	12mm	2.44m
FTE708	5019788007083	BLACK	12mm	2.44m
FTE894	5019788008943	SLATE GREY	12mm	2.44m
FTE220	5019788002200	WHITE	15mm	2.44m
FTE221	5019788002217	SOFT PEACH	15mm	2.44m
FTE336	5019788003368	AMERICAN BONE	15mm	2.44m
FTE386	5019788003863	BLACK	15mm	2.44m

Actual Size

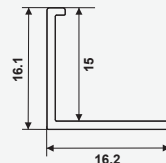
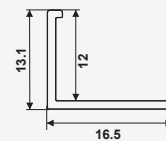
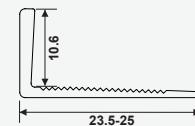
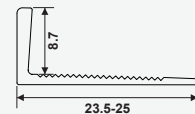

FOR MORE INFORMATION OR TO ORDER
CALL US ON: 01543 500 893

PVC TILE EDGE

PRO+ QUADRANT TILE EDGE

Tile Rite Profile Plus+ Quadrant Tile Trim is made of high quality Calcium Zinc stabilized Extrusion grade PVC. This unique tile trim offers an attractive, professional finish to tiled external corners and other tiled edges prone to damage.

Our unique Impact Absorption Zone is the design feature that makes the Profile Plus+ anything but "standard". This important zone allows the edge strip to absorb impacts without the grout cracking or tiles chipping.

Round edge PVC tile trim, protects and decorates tiled outer wall corners & other tiled edges prone to impact and damage.

- ✓ Unique Pro Plus® up-stand profile eliminates cracked grout joints.
- ✓ Corner pieces available* to create a 2 or 3 way join.
- ✓ Made of high quality Calcium Zinc stabilized Extrusion grade PVC suitable for indoor use.

Complimentary Products

These profiles have specifically designed internal & external corner pieces to provide a perfect safe edge where profiles meet.

- ✓ 2 corners per pack.



CODE	BARCODE	COLOUR	INT DEPTH	CORNER
TED435	5019788004358	WHITE	6mm	N/A
TED436	5019788004365	SOFT PEACH	6mm	N/A
TE566*	5019788005669	WHITE	7mm	NST640
TE564*	5019788005645	SOFT CREAM	7mm	NSTL645
TE568*	5019788005683	SOFT PEACH	7mm	NST641
TE570	5019788005706	IVORY	7mm	N/A
TE572*	5019788005720	GREY	7mm	NST642
TE579	5019788005799	ALMOND	7mm	N/A
TE581*	5019788005812	BLACK	7mm	NST644
TE591*	5019788005911	AMERICAN BONE	7mm	NST643
TE599	5019788005997	PALE GREY	7mm	N/A
TE567*	5019788005676	WHITE	9.5mm	NDE655
TE565*	5019788005652	SOFT CREAM	9.5mm	NDEL661
TE569*	5019788005690	SOFT PEACH	9.5mm	NDE656
TE571	5019788005713	IVORY	9.5mm	N/A
TE573*	5019788005737	GREY	9.5mm	NDE657
TE580	5019788005805	ALMOND	9.5mm	N/A
TE582*	5019788005829	BLACK	9.5mm	NDE659
TE592*	5019788005928	AMERICAN BONE	9.5mm	NDE658
TE599B	5019788003740	PALE GREY	9.5mm	N/A
TEL054*	5019788000541	WHITE	12mm	NXD671
TEL636	5019788006369	SOFT CREAM	12mm	N/A
TEL629*	5019788006291	SOFT PEACH	12mm	NXD672
TEL630	5019788006307	IVORY	12mm	N/A
TEL633*	5019788006338	GREY	12mm	NXD673
TEL634	5019788006345	ALMOND	12mm	N/A
TEL632*	5019788006321	BLACK	12mm	NXD675
TEL635*	5019788006352	AMERICAN BLONDE	12mm	NXD674
TEL631	5019788006314	PALE GREY	12mm	N/A

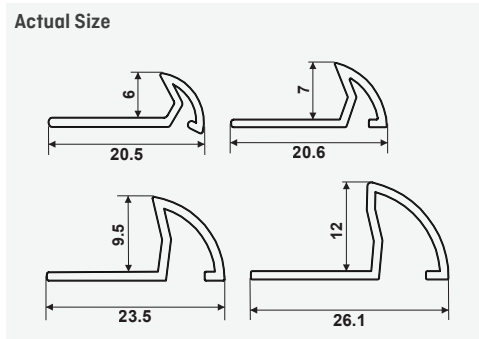
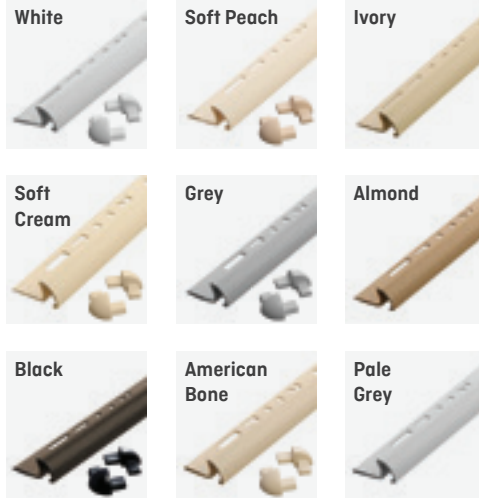

ULTRA SHINE L SHAPE TILE EDGE

Shiny finish L Shape profile PVC file trim is designed to protect and decorate tiled external corners and other tiled edges prone to damage.

PVC is suitable for a wide range of applications due to its excellent chemical resistance and requires no special maintenance. Clean periodically using a PH neutral detergent to maintain the appearance.

The raw material used in the manufacture of our PVC products is calcium zinc stabilized and contains no lead or substances of high concern. Suitable for indoor use.



Size Guide

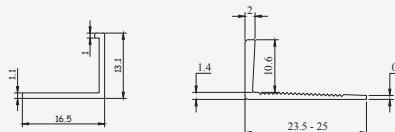

CODE	BARCODE	COLOUR	INT DEPTH	LENGTH
USL719	5019788007199	ULTRA SHINE WHITE	10.6mm	2.44m
USL720	5019788007205	ULTRA SHINE BLACK	10.6mm	2.44m
USL722	5019788007229	ULTRA SHINE WHITE	12mm	2.44m
USL723	5019788007236	ULTRA SHINE BLACK	12mm	2.44m

ULTRA SHINE QUADRANT TILE EDGE

Shiny finish quadrant profile PVC tile trim designed to protect and decorate tiled outer wall corners and other tiled edges prone to damage.

- ✓ Our unique impact absorption zone allows the edge strip to absorb impacts without the grout Cracking or tiles chipping.



NEED HELP OR ADVISE ON WHICH IS BEST FOR YOU? JUST CALL US OR VISIT OUR SITE:

WWW.TILERITE.CO.UK



Size Guide

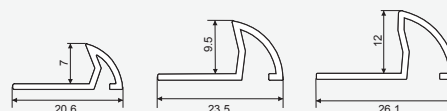

CODE	BARCODE	COLOUR	INT DEPTH	LENGTH
USQ800	5019788008004	WHITE	7.5mm	2.44m
USQ802	5019788008028	BLACK	7.5mm	2.44m
USQ787	5019788007876	WHITE	9.5mm	2.44m
USQ788	5019788007885	BLACK	9.5mm	2.44m
USQ785	5019788007854	WHITE	11.74mm	2.44m
USQ786	5019788007861	BLACK	11.74mm	2.44m

PROFILE PLUS ROPE EFFECT TILE TRIM

Tile Rite Profile Plus Rope Effect PVC tile trim is designed to protect and decorate tiled external corners and other tiled edges prone to damage.

Our unique Impact Absorption Zone is the design feature that makes the Profile Plus anything but "standard". This important zone allows the edge strip to absorb impacts without the grout cracking or tiles chipping.



White



Soft Peach



Black



**GET FREE DELIVERY
ON ALL ORDERS
OVER £150
NETT**

(UK MAINLAND ONLY)



CODE	BARCODE	COLOUR	INT DEPTH	LENGTH
RTE200	5019788002002	WHITE	7.4mm	2.44m
RTE201	5019788002019	SOFT PEACH	7.4mm	2.44m
RTE202	5019788002026	BLACK	7.4mm	2.44m
RTE207	5019788002071	WHITE	9.8mm	2.44m
RTE208	5019788002088	SOFT PEACH	9.8mm	2.44m
RTE212	5019788004754	BLACK	9.8mm	2.44m

Actual Size

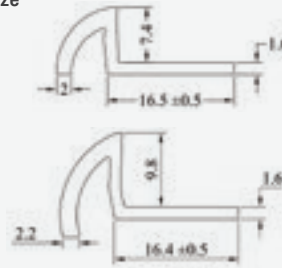

TRADE TRIM

Tile Rite PVC Trade Quadrant Tile Trim is a standard quadrant profile designed to protect and decorate tiled external corners and other tiled edges prone to damage.

These profiles are made from high quality Calcium Zinc stabilized extrusion grade PVC suitable for indoor use. This trim requires no special maintenance. Clean periodically using a PH neutral detergent to maintain the appearance.

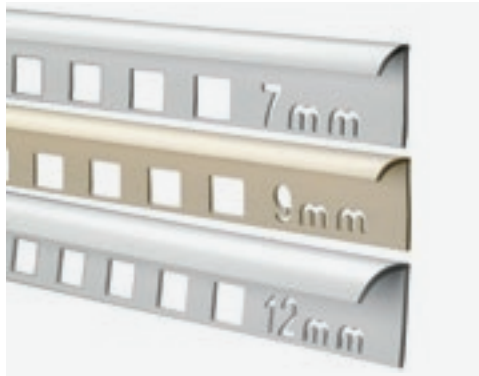

CODE	BARCODE	COLOUR	INT DEPTH	LENGTH
ETE803	5019788008035	WHITE	6.3mm	2.44m
ETE001	5019788009988	WHITE	7mm	2.44m
ETE002	5019788009971	SOFT PEACH	7mm	2.44m
ETE005	5019788009964	IVORY	7mm	2.44m
ETE017	5019788000176	AMERICAN BONE	7mm	2.44m
ETE018	5019788000183	BLACK	7mm	2.44m
ETE003	5019788009957	WHITE	9.3mm	2.44m
ETE004	5019788009940	SOFT PEACH	9.3mm	2.44m
ETE006	5019788009933	IVORY	9.3mm	2.44m
ETE013	5019788009896	BLACK	9.3mm	2.44m
ETE014	5019788009889	AMERICAN BONE	9.3mm	2.44m
ETE010	5019788009926	WHITE	12.2mm	2.44m
ETE011	5019788009919	SOFT PEACH	12.2mm	2.44m
ETE012	5019788009902	IVORY	12.2mm	2.44m
ETE015	5019788009872	AMERICAN BONE	12.2mm	2.44m
ETE016	5019788009865	BLACK	12.2mm	2.44m

Size Guide

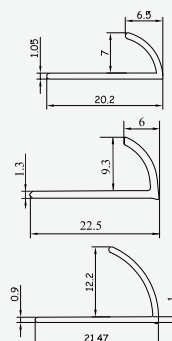



PVC CORNER GUARD



Tile Rite Corner guards are designed to absorb and protect against impact damage on outer tile corners and other edges subjected to lots of wear and tear.

Suitable for retro fixing, these profiles provide a decorative and clean finish as well as covering existing damage to walls.

Size Guide

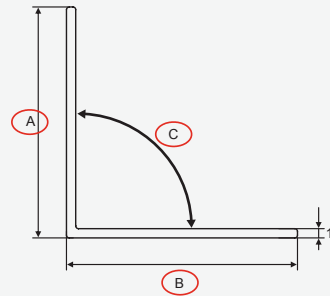

CODE	BARCODE	COLOUR	A	B	C	LENGTH
RCG847	5019788008479	WHITE	12.7mm	12.7mm	90°	3m
RCG286	5019788002866	WHITE	20mm	20mm	85°	3m
RCG627	5019788006277	WHITE	25mm	25mm	90°	3m
RCG831	5019788008318	WHITE	30mm	30mm	90°	3m

VINYL TO TILE CAPPING

Tile Rite Vinyl to Tile Capping provides a neat transition between Vinyl Flooring & Ceramic Tiles.

These profiles allow the floor covering to be continued up the wall for a neat and clean finish in wet and sanitised areas such as in bathrooms, wet rooms, changing facilities and kitchens etc, where ease of maintenance and hygiene are important. Can be used in conjunction with Altro, Linoleum and vinyl flooring.

- ✓ Available in 8.2mm & 10mm ledge depths.
- ✓ 2.44m lengths.
- ✓ Colour options available: White & Black.

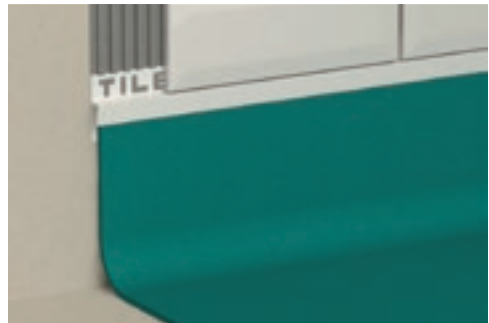

Size Guide

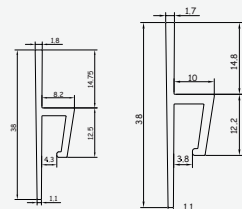

WANT TO KNOW MORE ABOUT THIS?
CALL US TODAY ON:
01543 500 893

CODE	BARCODE	COLOUR	INT DEPTH	LENGTH
VTC056	5019788000565	WHITE	8.2mm	2.44m
VTC437	5019788004372	BLACK	8.2mm	2.44m
VTC910	5019788009100	WHITE	10mm	2.44m

FOR MORE INFORMATION OR TO ORDER
CALL US ON: 01543 500 893

PVC TILE EDGE

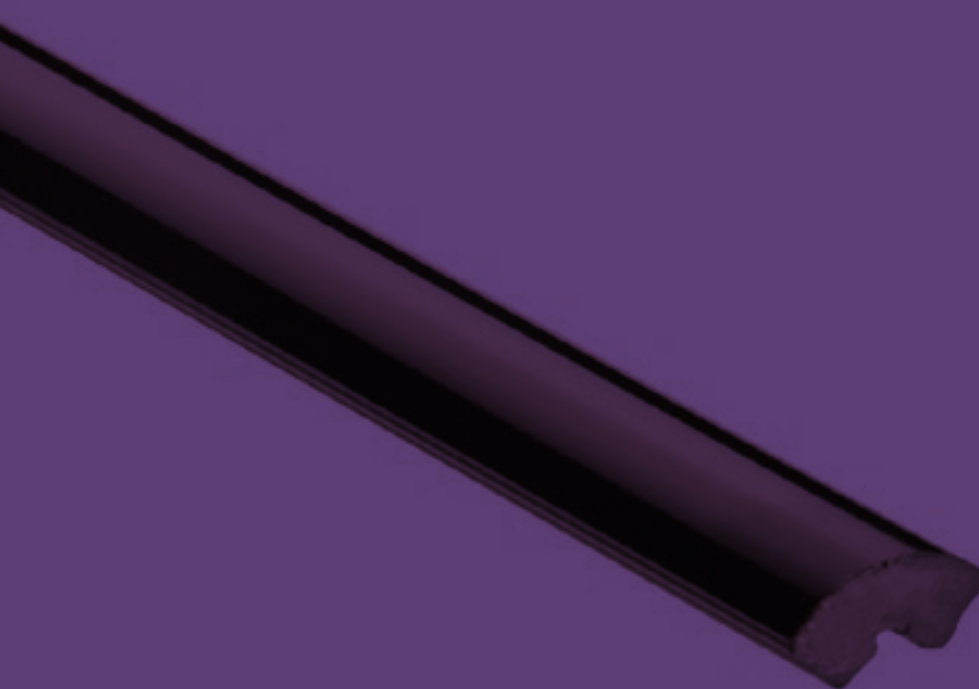

BATH TRIMS

TILE RITE OFFER DURING AND AFTER TILING SOLUTIONS FOR FINISHING AROUND YOUR BATH, SHOWER & KITCHEN WORK TOPS.

These trims provide a neat finish, hide joins & gaps between tiled surfaces and cover mouldy or unsightly silicone.

Within this section

- ✓ Bath & Kitchen Cove (after fit).
- ✓ Budget bath trim (after fit).
- ✓ Flexible bath seal (after fit).
- ✓ Heavy duty bath trim (before fit).



BATH & KITCHEN COVE



This ceramic effect trim hides the join between tiled surfaces around baths, showers & worktops.

It has a unique glazed ceramic effect to complement high gloss tiles and is easily applied with self-adhesive tape or silicone sealant.

Black



Chrome



White



Actual Size

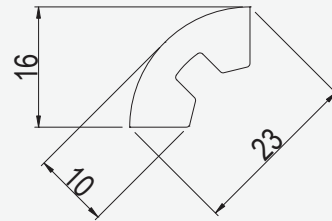

CODE	BARCODE	COLOUR	DIAMETER	INT DEPTH	LENGTH
BCC293	5019788002934	CHROME	16mm	10mm	1.8m
BCB291	5019788002910	BLACK	16mm	10mm	1.8m
BCW292	5019788002927	WHITE	16mm	10mm	1.8m

BUDGET BATH TRIM

An 'L' shape after fit bath trim, designed to create a neat finish around baths and showers. Easy to fit and prevents water and condensation from dripping behind the bath, shower tray or vanity unit.

- ✓ 22.5x22.5mm equal sided profile with flexible rubber edge.
- ✓ Fix with water resistant double-sided tape or silicone sealant (avoiding flexible edge).



Actual Size

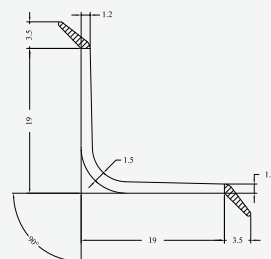

CODE	BARCODE	COLOUR	INT DEPTH	LENGTH	LENGTH
BBS621	5019788007144	WHITE	22.5x22.5mm	1.8m	1.8m

FOR MORE INFORMATION OR TO ORDER
CALL US ON: 01543 500 893

BATH TRIMS

**WANT TO KNOW
MORE ABOUT THIS?
CALL US
TODAY ON:
01543 500 893**



FLEXIBLE BATH SEAL

Seal around baths, showers and basins easily with this self-adhesive waterproof sealing tape; So easy to apply, just peel, press and unroll! Replaces the need for silicone sealant in domestic applications.

- ✓ 3.5m (11.5') self-adhesive waterproof sealant tape.
- ✓ Sealant tape for use around baths, basins & showers.
- ✓ Easy to apply just press and unroll.
- ✓ All traces of silicone / mastic must be removed before application.



CODE	BARCODE	COLOUR	INT DEPTH	LENGTH
FBS718	5019788007182	WHITE	23mm	3.5m

HEAVY DUTY BATH TRIM

Heavy Duty Bath Trim is an effective, long lasting PVC seal that can be fixed around baths and shower trays during tiling.

- ✓ Fit behind the tiles by bedding firmly into the adhesive.
- ✓ Corner pieces and end caps available.

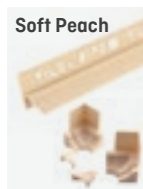

GET FREE DELIVERY
ON ALL ORDERS
OVER £150
NETT

(UK MAINLAND ONLY)



Size Guide

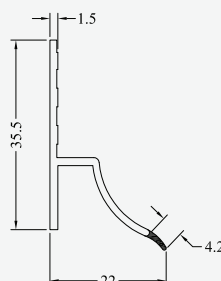

CODE	BARCODE	COLOUR	FIXING KIT	INT DEPTH	LENGTH
BS601	5019788006017	WHITE	FPW527	7mm	1.8m
BS605	5019788006055	SOFT PEACH	FPSP527	7mm	1.8m
BS617	5019788006178	BLACK	X	7mm	1.8m



FOR MORE INFORMATION OR TO ORDER
CALL US ON: 01543 500 893

TILE CUTTING MACHINES

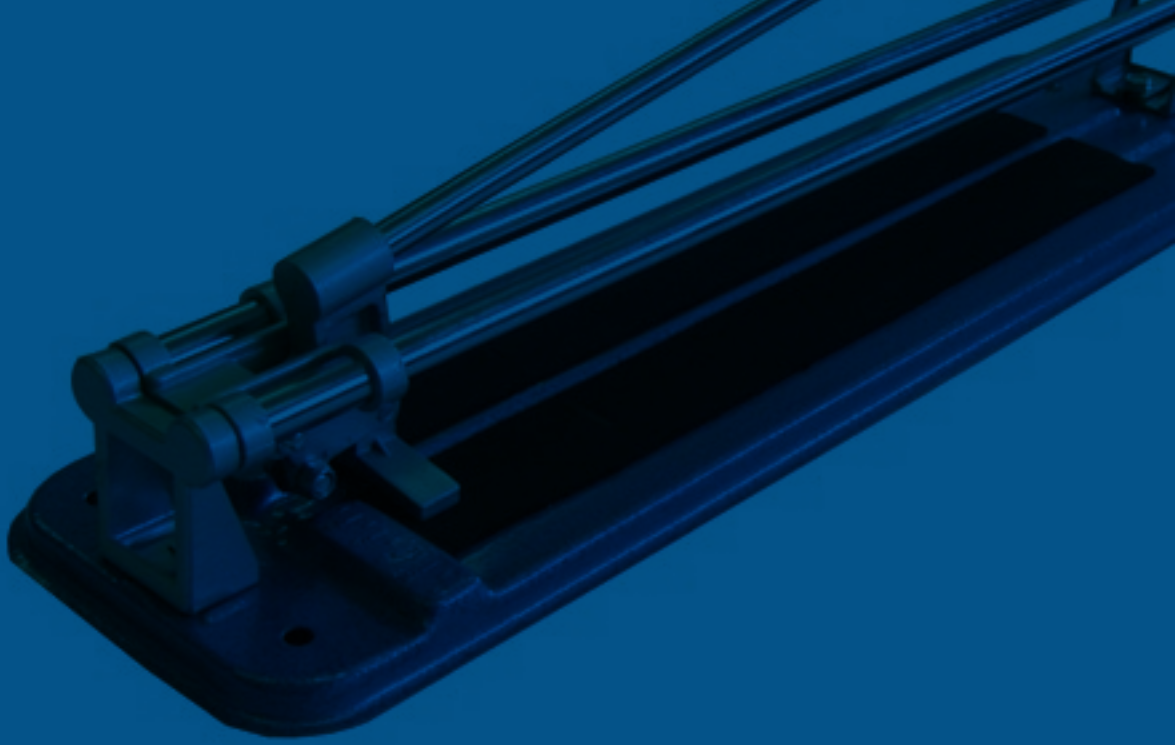

TILE CUTTING MACHINES

TILE RITE OFFER A RANGE OF TILE CUTTING SOLUTIONS TO COMPLETE ANY TILING PROJECT FOR THE PROFESSIONAL OR DIY USER.

Our electric machines are suitable for wet tile cutting and range from our small portables to our large bench style cutters. Electric tile cutters are ideal to cope with a wide variety of cuts including straight & angled, profile & diagonal cuts, pipe cuts, inset cuts and mitre cuts.

If it is just straight tile cutting you need, we offer a variety of small bed manual tile cutters suitable for traditional tile types, and we also offer large bed tile cutters suitable for cutting large format porcelain tiles.

Within this section

- ✓ Bench Cutters.
- ✓ Portable tile cutters.
- ✓ Angle grinder.
- ✓ Replacement blades.
- ✓ Diy manual tile cutters.
- ✓ Professional manual cutters.
- ✓ Replacement wheels.

NVTC BENCH CUTTER SERIES

These stone cutting machines are designed exclusively for wet cutting Ceramic, Marble, Clinker, Porcelain etc; and come fitted with a continuous rim diamond blade.

They have a tilting radial arm that allows cuts at 45 degrees. Special diamond discs are required for machining granite, fine stoneware and glazed tiles.

IMPORTANT: Designed exclusively for wet cutting; Suitable for private and professional use.

- ✓ This is a Professional Tile Saw with integral water tank.
- ✓ Included with the saw is a blade guard, spanner and dual feed submersible water pump.
- ✓ Direct drive motor.
- ✓ Bevel cuts 0-45 degrees.
- ✓ Rubber non-slip bed.



WANT TO KNOW MORE ABOUT THIS?

CALL US TODAY ON:

01543 500 893

CODE	MOTOR	VOLTAGE	BLADE SIZE	RPM	RADIAL ARM	CUT DEPTH	TABLE SIZE	MAX CUT LENGTH	PLUNGE CUT	WEIGHT	REPLACEMENT WHEEL
NVTC600	800w	230v/50hz	200 x 25.4mm	3000 min-1	90°-45°	90°/40mm : 45°/25mm	695x403mm	600mm	NO	36/35kg	SBLO64
NVTC750	1500w	230v/50hz	250 x 25.4mm	3000 min-1	90°-45°	90°/60mm : 45°/48mm	810x500mm	750mm	YES	67/62kg	NVTCW378
NVTC1000	1800w	230v/50hz	250 x 25.4mm	3000 min-1	90°-45°	90°/60mm : 45°/48mm	1110x503mm	1000mm	YES	70/63kg	NVTCW378

550W PRO ELECTRIC SAW WITH EXTENDING TABLE

Portable wet tile cutter with extending table for cutting and mitring many types of wall & floor tiles including Porcelain.

- ✓ 200mm diamond cutting wheel with safety shield.
- ✓ Electric components earthed & water sealed for safety.
- ✓ Sealed magnetic ON/OFF switch.
- ✓ Adjustable cutting guide with built in ruler.
- ✓ Angle cutting guide for corner cuts & mitre fence for bevel cuts.



CODE	MOTOR	VOLTAGE	RPM	CUT DEPTH	BLADE SIZE	MAX CUT LENGTH	TABLE SIZE	WEIGHT	REPLACEMENT BLADE
LPG059	550w	230v/50hz	2950 min-1	32mm	255x25.4mm	600mm	440 x 480mm >600mm	15.8kg	SBLO64



450W ELECTRIC TILE CUTTER



Compact portable diamond wheel tile cutter for cutting & mitring wall & floor ceramics & tiles.

- ✓ Extension table for larger tiles from 360-440mm.
- ✓ Carry handle for easy transportation.
- ✓ Self-contained water reservoir.
- ✓ Blade Size: 110mm x x22.23mm.
- ✓ Compatible with TRB452 continuous rim diamond blade & GLB790 glass cutting blade.



CODE	MOTOR	VOLTAGE	RPM	CUT DEPTH	BLADE SIZE	MAX CUT LENGTH	TABLE SIZE	EXTENDED TABLE SIZE	WEIGHT	REPLACEMENT WHEELS
TRP438	450w	230-240v/50hz	5400/min	90°/23mm : 45°/16mm	110x22.23mm	n/a	360mm (w) x 310mm (d)	440mm (w) x 310mm (d)	5kg	TRB452 & GLB790

115MM DIAMOND CUTTING & GRINDING WHEEL

Multipurpose diamond cutting & grinding blade for making small cuts indentations and more into marble, granite, travertine wall & floor tiles and many other surfaces.

Suitable for use with the Tile Rite Angle Grinder AGR260.

- ✓ Grinds, bevels, and rounds.
- ✓ Makes small cuts indentations & more.
- ✓ Medium Grit.

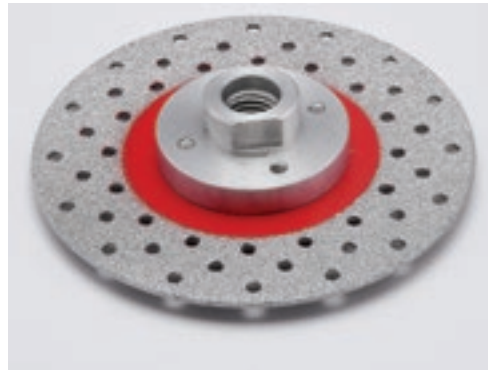

CODE	BARCODE	BLADE DIA	BORE SIZE	GRIT TYPE	MAX RPM	MAX CUT DEPTH	BLADE TYPE	TILE TYPES	WEIGHT
DCW888	5019788008882	115mm	M14 fitting	50-60 medium	12,000	30mm	diamond coated for cutting & grinding	porcelain	0.19kg

FOR MORE INFORMATION OR TO ORDER
CALL US ON: 01543 500 893

TILE CUTTING MACHINES

TILE RITE ANGLE GRINDER



For the grinding and cutting of steel materials.

The M14 spindle thread also makes it suitable for use with Tile Rite M14 brazed diamond drill bits.

- ✓ Supplied & fitted with 115mm grinding disc and blade guard.
- ✓ Supplied with a cutting guard for use with Tile Rite turbo angle grinder blades.
- ✓ Supplied with side handle which can be positioned left or right.
- ✓ Comes with disc replacement wrench & extra set of carbon brushes.
- ✓ Two step on/off switch.



COMPLIMENTARY PRODUCTS



The Tile Rite Angle Grinder is suitable for use with the following products.

- ✓ M14 Brazed Diamond Drill Bits.
- ✓ WDB458 & STT247 115mm Wet & Dry Angle Grinder Wheels.
- ✓ DCW888 115mm Diamond Cutting & Grinding Wheel.

CODE	VOLTAGE	FREQUENCY	MOTOR	NO-LOAD SPEED	BLADE SIZE	WEIGHT	DIMENSIONS
AGR260	230v	50 hz	750w	12000 r/min	115mm x 22.23mm	ca. 1.98kg	260 x 85 x 70mm



FOR MORE INFORMATION OR TO ORDER
CALL US ON: 01543 500 893

TILE CUTTING MACHINES

ANGLE GRINDER SUPER THIN TURBO BLADE

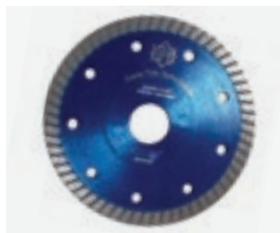

- ✓ 115mm Super thin wet & dry blade suitable for angle grinding tools & wet tile cutters.
- ✓ Precision cutting with reduced chipping of tile.
- ✓ Wheel has a 22.23mm bore hole, that can be reduced to 16mm with the spacer bush included.

CODE	STT247
BLADE DIA	115mm
BORE SIZE	22.23mm>16mm
THICKNESS	1.15mm
MAX RPM	13300
MAX CUT DEPTH	32mm
BLADE TYPE	turbo for wet & dry cutting
TILE TYPES	natural & artificial stone
WEIGHT	0.13kg

ANGLE GRINDER WET & DRY TURBO BLADE



- ✓ 115mm wet & dry blade suitable for angle grinding tools & wet tile cutters.
- ✓ Precision cutting with reduced chipping of tile.
- ✓ Wheel has a 22.23mm bore hole, that can be reduced to 16mm with the spacer bush included.

CODE	WDB458
BLADE DIA	115mm
BORE SIZE	22.23mm>16mm
MAX RPM	14500
MAX CUT DEPTH	40mm
BLADE TYPE	turbo for wet & dry cutting
TILE TYPES	natural & artificial stone
THICKNESS	1.4mm
WEIGHT	0.16kg

ANGLE GRINDER METAL CUTTING DISCS



- ✓ For the dry cutting of stainless steel & aluminium profiles.
- ✓ Ideal for cutting tile trim.
- ✓ For use with angle grinders.
- ✓ 115 x 1.2 x 22.2mm.

CODE	MCD478
BLADE DIA	115mm
BORE SIZE	22.23mm
THICKNESS	1.2mm
MAX RPM	13300
MAX CUT DEPTH	32mm
BLADE TYPE	for dry cutting
MATERIAL TYPES	stainless steel/ aluminium
WEIGHT	0.13kg

110MM GLASS CUTTING BLADE



- ✓ Premium quality blade suitable for the wet cutting of glass & glass mosaic tiles.
- ✓ Suitable for use with Tile Rite TRP438 450W portable electric tile cutter.
- ✓ 110mm x 22.23mm.

CODE	GLB790
BLADE DIA	110mm
BORE SIZE	22.23mm>16mm
THICKNESS	1.3mm
MAX RPM	13800
MAX CUT DEPTH	20mm
BLADE TYPE	diamond for wet cutting
MATERIAL TYPES	glass tiles
WEIGHT	0.10kg

110MM DIAMOND SPARE BLADE



- ✓ Continuous rim diamond blade for use in wet tile cutters.
- ✓ Use water as a coolant (for wet tile cutting only)
- ✓ Max RPM 13800.
- ✓ Max. 80m/s
- ✓ Suitable for use with the Tile Rite TRP452.

CODE	TRB452
BLADE DIA	110mm
BORE SIZE	22.23mm
MAX RPM	13800
MAX CUT DEPTH	23mm
BLADE TYPE	continuous rim for wet cutting
TILE TYPES	tile & stone
WEIGHT	0.08kg
WEIGHT	0.45kg

180MM CONTINUOUS RIM DIAMOND BLADE



- ✓ Continuous rim diamond blade for use in wet tile cutters
- ✓ Specifically designed for cutting porcelain.
- ✓ Use water as a coolant (for wet tile cutting only)
- ✓ 180 x 22.23mm.

CODE	SDB547
BLADE DIA	180mm
BORE SIZE	22.23mm
THICKNESS	1.6mm
MAX RPM	8730
MAX CUT DEPTH	20mm
BLADE TYPE	continuous rim diamond for wet cutting
TILE TYPES	porcelain
WEIGHT	0.33kg

180MM QUALITY DIAMOND SPARE BLADE

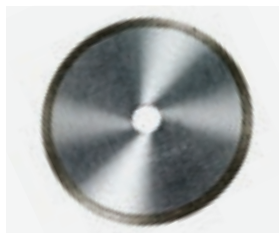

- ✓ High quality continuous rim diamond blade for use in wet tile cutters and bench saws.
- ✓ Specifically designed for cutting porcelain.
- ✓ Use water as a coolant (for wet tile cutting only).
- ✓ 180 x 25.4mm.

CODE	QW0319
BLADE DIA	180mm
BORE SIZE	25.4mm
THICKNESS	2mm
MAX RPM	6110
MAX CUT DEPTH	20mm
BLADE TYPE	continuous rim diamond for wet cutting
TILE TYPES	porcelain
WEIGHT	0.34kg

200MM DIAMOND SPARE BLADE



- ✓ Continuous rim diamond blade for use in wet tile cutters and bench saws.
- ✓ Specifically designed for cutting porcelain.
- ✓ Use water as a coolant (for wet tile cutting only).
- ✓ For use in Tile Rite NVTC600 & LPG059.
- ✓ 200 x 25.4mm.

CODE	SBL064
BLADE DIA	200mm
BORE SIZE	25.4mm
THICKNESS	1.6mm
MAX RPM	6110
MAX CUT DEPTH	40mm
BLADE TYPE	continuous rim diamond for wet cutting
TILE TYPES	porcelain
WEIGHT	0.45kg

250MM CONTINUOUS RIM DIAMOND BLADE



- ✓ Continuous rim diamond blade for use in wet tile cutters and bench saws.
- ✓ Specifically designed for cutting porcelain.
- ✓ Use water as a coolant (for wet tile cutting only).
- ✓ 250 x 25.4mm.

CODE	NVTCW378
BLADE DIA	250mm
BORE SIZE	25.4mm
THICKNESS	2mm
MAX RPM	7640
MAX CUT DEPTH	40mm
BLADE TYPE	continuous rim diamond for wet cutting
MATERIAL TYPES	porcelain
WEIGHT	0.7kg

400MM ECONOMY TILE CUTTER



Suitable for cutting ceramic wall & floor tiles

- ✓ Max cutting length 400mm.
- ✓ Cuts tiles up to 10mm thick.
- ✓ Easy to use machine with metal base & built in ruler.
- ✓ Replaceable tungsten carbide wheel 15 x 6 x 1.5mm.

CODE	CUT DEPTH	MAX CUT LENGTH	WHEEL SIZE	WEIGHT	REPLACEMENT WHEEL
DS401E	10mm	400mm	15 x 6 x 1.5mm	1.75kg	DSW301P

600MM MANUAL TILE CUTTER



For cutting wall & floor ceramics & tiles up to 600mm

- ✓ Cuts tiles up to 12mm thick.
- ✓ Easy to use machine.
- ✓ For straight & angles cutting.
- ✓ Adjustable ruler & cutting guide.
- ✓ Replaceable tungsten carbide wheel 15 x 6 x 1.5mm.

CODE	CUT DEPTH	MAX CUT LENGTH	WHEEL SIZE	WEIGHT	REPLACEMENT WHEEL
MTC281	12mm	600mm	15 x 6 x 1.5mm	5.76kg	DSW301P



9 PCS TILING TOOL KIT

FOR MORE INFORMATION OR TO ORDER
CALL US ON: 01543 500 893

TILE CUTTING MACHINES



Tiling starter kit includes all the essential tools to start your tiling job

- ✓ 400mm tile cutter for cutting Ceramic wall and floor tiles up to 400mm in length and up to 10mm thick.
- ✓ Grout finisher for making smooth professional looking grout lines.
- ✓ Pair of vinyl gloves to protect your hands from adhesive & grout.
- ✓ Chinagraph marker for marking on to tiles.
- ✓ 6mm square notched adhesive trowel for spreading tile adhesive.
- ✓ Tile trimmer for smoothing the cut edges of a tile.
- ✓ Grout spreader for directing grout in to tile joints.
- ✓ Sponge for cleaning up after grouting.
- ✓ 250 x 2mm tile spacers for the even spacing and alignment of tiles and for creating a uniform thickness to your grout lines.



FOR BEST RESULTS:

Get replacement wheels: 15 x 6 x 1.5mm Tungsten Carbide Cutting Wheels x 2 ref: DSW301



CODE	CUT DEPTH	MAX CUT LENGTH	WHEEL SIZE	WEIGHT	DSW301P
NTK459	10MM	400MM	15 X 6 X 1.5MM	2.35KG	DSW301P

A SERIES 1000MM TILE CUTTER

New structure aluminum base tile cutter designed for cutting large polished porcelain & ceramic tiles.

- ✓ Six bearings design with single bar.
- ✓ Fine finishing & stronger head.
- ✓ Super hard alloy scoring wheel.
- ✓ Max cut length 1000mm.
- ✓ Available with laser.

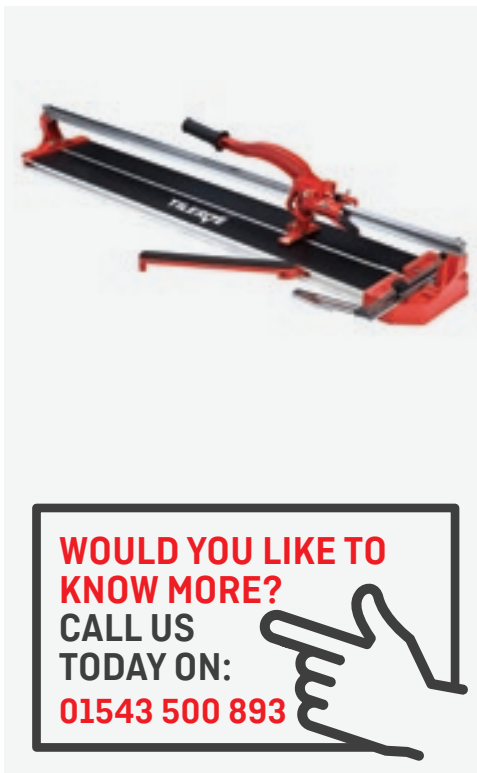

Without Laser

CODE	CUT DEPTH	MAX CUT LENGTH	WHEEL SIZE	WEIGHT	REPLACEMENT WHEEL:
ATC469	16mm	1000mm	22 x 5 x 6mm	24.3kg	ATCW639(V)

With Laser

CODE	CUT DEPTH	MAX CUT LENGTH	WHEEL SIZE	WEIGHT	REPLACEMENT WHEEL:
ATC469(R)	12mm	1000mm	22 x 6 x 6mm	24.3kg	ATCW639(R)

WOULD YOU LIKE TO KNOW MORE?

CALL US TODAY ON:

01543 500 893



OTC CUTTER SERIES

Heavy duty tile cutters with interior bearings, for the high precision cutting of wall & floor tiles. Available with 600mm, 1000mm & 1200mm beds.

- ✓ Clean, Smooth, Fast & Easy Action.
- ✓ Part assembly required.
- ✓ Aluminium base.
- ✓ Single guide rail.
- ✓ 6 ball bearings for smooth cutting.
- ✓ 0-45-degree adjustable steel ruler.
- ✓ Fitted with a Tungsten Carbide Cutting Wheel 22x10.5x2mm.
- ✓ Cut depth: 7-16mm.



GET FREE DELIVERY ON ALL ORDERS OVER £150 NETT

(UK MAINLAND ONLY)



CODE	CUT DEPTH	MAX CUT LENGTH	WHEEL SIZE	WEIGHT	REPLACEMENT WHEEL
OTC206	18mm	600mm	22 x 10.5 x 2mm	7.23kg	OTCW843 & BBW092
OTC624	18mm	1000mm	23 x 10.5 x 2mm	10.25kg	OTCW843 & BBW092
OTC255	18mm	1200mm	24 x 10.5 x 2mm	10.50kg	OTCW843 & BBW092



FOR MORE INFORMATION OR TO ORDER
CALL US ON: 01543 500 893

TILE CUTTING MACHINES

TITANIUM COATED TUNGSTEN CARBIDE MANUAL TILE CUTTER WHEEL WITH FIXING BOLT.



- ✓ 22 x 10.5 x 2mm.
- ✓ Comes with mount & fixing bolt.
- ✓ Can be used with the OTC tile cutter series (OTC206 / OTC624 / OTC255).

CODE	WHEEL DIAMETER	BORE SIZE	THICKNESS	BLADE TYPE
BBW092	22mm	10.5mm	2mm	titanium coated

22 X 6 X 6.5MM TOUGH TUNGSTEN CARBIDE MANUAL TILE CUTTER WHEELS X 2

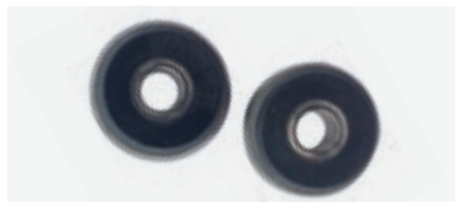

- ✓ 22 x 6 x 6.5mm.
- ✓ Can be used with the following Tile Rite Tile Cutters; CTC660 / CTC570.

CODE	WHEEL DIAMETER	BORE SIZE	THICKNESS	BLADE TYPE
DSW571	22mm	6mm	6.5mm	tungsten carbide

22 X 6 X 4.6MM TUNGSTEN CARBIDE CUTTING WHEEL

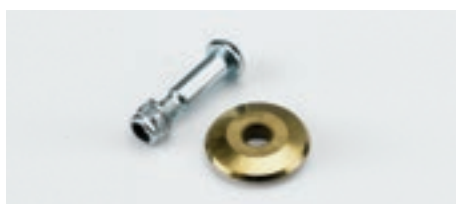

- ✓ Titanium coated tungsten carbide wheel with fixing bolt.
- ✓ 22 x 6 x 4.6mm.
- ✓ Can be used with the following Tile Rite Tile Cutters; EZW076.

CODE	WHEEL DIAMETER	BORE SIZE	THICKNESS	BLADE TYPE
EZW091	22mm	6mm	4.6mm	tungsten carbide

22 X 6 X 2MM TUNGSTEN CARBIDE CUTTING WHEEL



- ✓ 2 x Tough tungsten carbide manual tile cutter wheels.
- ✓ 22 x 6 x 2mm.
- ✓ Can be used with the following Tile Rite Tile Cutters; CTC460 / DS350.

CODE	WHEEL DIAMETER	BORE SIZE	THICKNESS	BLADE TYPE
DSW331P	22mm	6mm	2mm	tungsten carbide

22 X 6 X 6.5MM REPLACEMENT CUTTER WHEEL



- ✓ Titanium coated tungsten carbide wheel with fixing bolt.
- ✓ 22 x 6 x 6.5mm.
- ✓ Can be used with the following Tile Rite Tile Cutters; CTC660 / CTC570.

CODE	WHEEL DIAMETER	BORE SIZE	THICKNESS	BLADE TYPE
DSW571	22mm	6mm	6.5mm	titanium coated tungsten carbide

15 X 6 X 1.5MM TUNGSTEN CARBIDE CUTTING WHEELS X 2



- ✓ 2 x Tough tungsten carbide manual tile cutter wheels.
- ✓ 15 x 6 x 1.5mm.
- ✓ Can be used with the following Tile Rite Tile Cutters; MTC281 / RTC400 / DS401E / DSP299 / NTK45.

CODE	WHEEL DIAMETER	BORE SIZE	THICKNESS	BLADE TYPE
DSW301	15mm	6mm	1.5mm	tungsten carbide

PORCELAIN SCORING WHEEL



These high accuracy manual tile cutter replacement wheels are adaptable to the Tile Rite JTC329 & JTC309 models & Plasplugs Powerglide PGL600 (it also fits in other tile cutter brands).

The Tungsten Carbide scoring wheel is specially designed for all types of materials.

- ✓ For wall tiles, floor tiles and porcelain tiles.
- ✓ Tungsten carbide scoring wheel with a superficial titanium treatment; high resistance and durability.
- ✓ Easy to replace.

GET FREE DELIVERY
ON ALL ORDERS
OVER £150
NETT

(UK MAINLAND ONLY)



CODE	WHEEL DIAMETER	BLADE TYPE	TILE TYPES
JTW330	6mm	titanium coated tungsten carbide	porcelain
JTW332	8mm	titanium coated tungsten carbide	porcelain
JTW333	10mm	titanium coated tungsten carbide	porcelain

22 X 5 X 6MM REPLACEMENT TUNGSTEN CUTTING WHEEL WITH BEARING



- ✓ For use with ATC469 tile cutter (without laser).
- ✓ Comes with mount and fixing bolt.

CODE	SIZE
ATCW639(V)	22 x 5 x 6mm

22X6X6MM REPLACEMENT TITANIUM COATED CUTTING WHEEL WITH BEARING

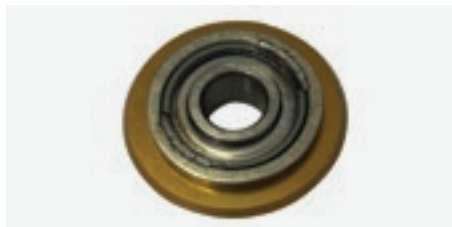

- ✓ For use with ATC469(R) tile cutter (with laser).
- ✓ Titanium Coated.

CODE	SIZE
ATCW639(R)	22 x 6 x 6mm

22 X 10.55 X 2MM REPLACEMENT WHEEL



Titanium coated tungsten carbide manual tile cutter wheel

- ✓ 22x10.5x2mm.
- ✓ Can be used with the OTC tile cutter series OTC206, OTC624 & OTC255.

CODE	WHEEL DIAMETER	BORE SIZE	THICKNESS	BLADE TYPE
OTCW843	22mm	10.5mm	2mm	titanium coated



FOR MORE INFORMATION OR TO ORDER
CALL US ON: 01543 500 893

POWER MIXERS & ACCESSORIES

POWER MIXERS & ACCESSORIES

TILE RITE OFFER A SMALL RANGE OF ELECTRIC MIXERS AND PADDLES WITH SPECIFIC HEADS FOR DIFFERENT MATERIALS.

Our range of mixing paddles include mixing paddles for drills that have a hexagonal arm (for drills or mixer with a chuck) and M14 connection, for use with most electric mixers.

With the proper mixing paddle, you will be able to mix a variety of materials, such as mortar, plaster, paint or epoxy resins, allowing you to reach the mixing requirements of the manufacturers.

Within this section

- ✓ Electric Mixer.
- ✓ Replacement Paddles.
- ✓ Flexi Bucket.

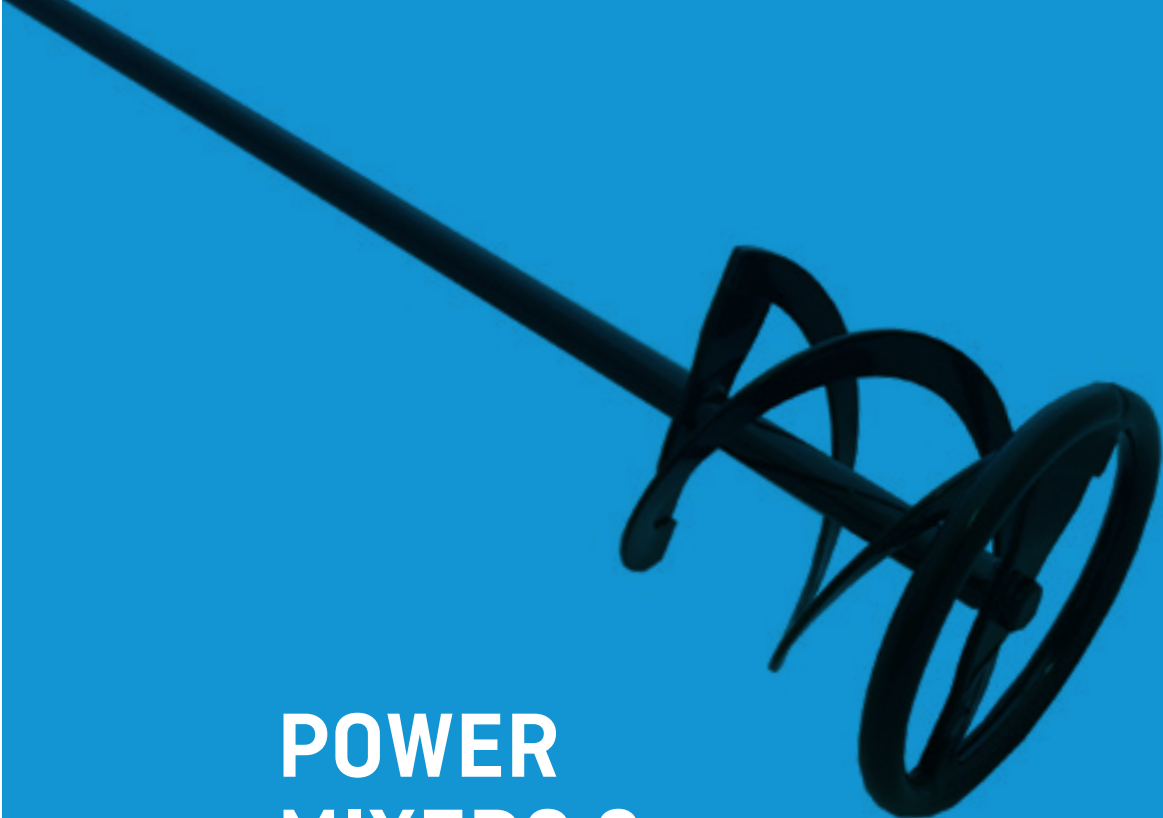

1050W TILE RITE POWER MIXER

230V Electric power mixer for mixing cement, plaster, grout, adhesives, fillers & paint plus other mortars for construction.

- ✓ Rotation & frequency adjustment with lock on switch.
- ✓ M14 internal thread.
- ✓ 120mm 2-part mixing paddle.
- ✓ 3 blade propeller head design has a bottom to top movement to create maximum efficiency & optimum consistency.
- ✓ Head ring to preserve tank bottom.



WOULD YOU LIKE TO KNOW MORE?

CALL US TODAY ON:

01543 500 893



CODE	BARCODE	POWER SUPPLY	MOTOR	RPM (no load)	NO OF GEARS	MIX PADDLE DIA:	LENGTH
TPM1050	5019788004426	230V / 50Hz	1050W	0-550rpm	1	120mm	590mm

120 X 600MM REPLACEMENT M14 MIX PADDLE

This screw spiral paddle turns and lifts the mix from bottom to top; it is the most effective paddle for heavier mortars, epoxy, render and screed.

- ✓ The rim that is placed at the bottom of the paddle around the blades protects the tub or container being used.
- ✓ M14 thread for use with power mixers.
- ✓ Suitable for use with Tile Rite TPM1050.



DID YOU KNOW?
THIS MIXING PADDLE IS SUITABLE FOR USE WITH THE 1050w ELECTRIC POWER MIXER



CODE	BARCODE	USE WITH	HANDLE SIZE	BLADE SIZE
RMP316	519788003160	heavy mortar, epoxy, render & screed	80x8x400mm	255x25.4mm



FOR MORE INFORMATION OR TO ORDER
CALL US ON: 01543 500 893

POWER MIXERS & ACCESSORIES

PRO MIXING PADDLE

This screw spiral paddle with protective rim, turns and lifts the mix from bottom to top; it is the most effective paddle for heavier mortars, epoxy, render and screed.

- ✓ Protective rim will not damage your tub.
- ✓ Hexagonal steel handle for use with an electric power drill.
- ✓ Size: 100 x 10 x 600mm.



CODE	BARCODE	SIZE	USE WITH
TMP164	5019788001647	100 X 10 X 600MM	ELECTRIC POWER DRILL

MIXING PADDLE SMALL

This paddle will help produce a low splash mix with the twin propeller paddles producing a parallel mix action helping to blend and spread the materials used.

- ✓ Ideal for mixing powder adhesive, plaster & paint.
- ✓ Hexagonal steel handle. Size: 80 x 8 x 400mm.
- ✓ For use with any standard power drill.



CODE	BARCODE	HANDLE	HANDLE SIZE	BLADE SIZE
MPS158	5019788001586	hexagonal steel	80x8x400mm	255x25.4mm

TILE RITE FLEXI BUCKET

With its large 38 Litre capacity and flexibility, this tub is ideal for a variety of uses including mixing, carrying rubble, tool storage and more!

- ✓ Made from 100% recycled material.
- ✓ Frost & UV resistant.
- ✓ Flexible but extremely strong.
- ✓ 100% phosphate free.
- ✓ Dimensions: H:33cm Dia:45cm.



CODE	BARCODE	HEIGHT	DIAMETER	CAPACITY
TFB285	519788002859	33cm	45mm	38 litres



HAND CUTTING TOOLS

IN THIS SECTION YOU
WILL FIND A SELECTION
OF HAND CUTTING TOOLS
AND ACCESSORIES FOR
CUTTING AND SHAPING
TILES AND TILE TRIM.

Within this section

- ✓ Tile Nippers.
- ✓ Trim Cutters.
- ✓ Scibes & Saws.
- ✓ Tile Shaping Tools.
- ✓ Replacement Blades.

PARROT NIBBLER



Designed to trim and shape glazed wall tiles up to a tile thickness of 8mm.

- ✓ The parrot shaped tungsten carbide jaws are shaped to give a greater degree of control so is suitable for more intricate work.
- ✓ 190mm (7 1/2") drop forged tile nipper commonly used on mosaic tiles.

CODE	BARCODE	SIZE	DESCRIPTION
PNB550	5019788005508	190mm drop forged	parrot nibbler

HEAVY DUTY QUARRY TILE NIPPER



Designed to nibble narrow strips and shapes from wall or floor tiles up to a maximum tile thickness of 12mm.

- ✓ 255mm (10") heavy duty tile nippers with a drop forged body and carbide tipped straight jaws.
- ✓ PVC handles.

CODE	BARCODE	SIZE	DESCRIPTION
QTN548	5019788005485	255mm drop forged	heavy quarry nipper

TITANIUM WHEEL TILE NIPPER



Designed to make ease of nipping tile, glass, ceramic & mosaic to high precision.

- ✓ Fitted with 22mm titanium cutting wheels.
- ✓ Will cut up to a maximum tile thickness of 12mm with minimal crushing and splintering.
- ✓ Easily cuts moulded tile into quarters, halves and triangles.
- ✓ Great for nipping up small pieces of stained glass.
- ✓ Soft grip double dipped handles for comfort.

CODE	BARCODE	SIZE	DESCRIPTION
TWN284	5019788002842	up to 12mm thick	titanium wheel tile nipper



FOR BEST RESULTS:

Get replacement wheels: 22 x 6 x 2mm Tungsten Carbide Cutting Wheel ref: DSW331P



COMFORT GRIP TILE NIPPER

Professional tile nipper designed to nibble narrow strips and shapes from wall or floor tiles; cuts up to a maximum tile thickness of 10mm; double dipped handle with comfort grip; It is well worth while spending a little time when cutting shapes into a tile.

Firstly, draw up a template of the tile to be cut. When using a tile nipper, you should aim to cut a small piece at a time, as trying to cut too much at one time may lead to the tile breaking. Begin by cutting in from the edge of the tile and work towards the lines you have marked. As you get closer to any corners that need to be cut work from the outside of the tile towards the corner. Clean out the corner carefully, using a tile file if necessary.

- ✓ Designed to nibble narrow strips and shapes from wall or floor tiles up to 10mm thick.
- ✓ Double dipped handle with comfort grip.



CODE	BARCODE	SIZE	DESCRIPTION
CGN363	5019788003634	for tiles up to 10mm thick	comfort grip tile nipper

TILE NIPPER



Designed to nibble narrow strips and shapes from wall or floor tiles up to 12mm thick.

- ✓ 205mm (8") drop forged tile nipper with classic carbide tipped straight jaws.
- ✓ PVC handles.

CODE	BARCODE	SIZE	DESCRIPTION
TN513	5019788005133	205mm drop forged	tile nipper

PRO TILE NIPPER



Designed to nibble narrow strips and shapes from wall or floor tiles up to 12mm thick.

- ✓ 215mm (8 inches) drop forged tile nippers.
- ✓ double dipped comfort grip handle.
- ✓ 'V' type spring.

CODE	BARCODE	SIZE	DESCRIPTION
GTN163	5019788001630	for tiles up to 12mm thick	professional tile nipper



FOR MORE INFORMATION OR TO ORDER
CALL US ON: 01543 500 893

HAND CUTTING TOOLS

TRIM CUTTER WITH STANLEY BLADE

Multi angle hand cutter designed to make ease of cutting and mitring PVC tile trims. Comes fully assembled with a replaceable super sharp Stanley type blade. Blade is lockable for safety. Comfort soft grip handles.

- ✓ Multi angle hand cutter ideal for cutting plastic tile trims, soft woods, rubber etc.
- ✓ Heavy duty steel construction.
- ✓ Angles marked on cutting surface for perfect mitres every time.
- ✓ Non slip soft grip handles.
- ✓ Replaceable Stanley type blade.



CODE	BARCODE	DESCRIPTION
TTC445	5019788004457	trim cutter c/w stanley blade

MITRE RITE TRIM SHEAR + GUIDE

Professional quality multi angle hand cutter designed to make ease of cutting and mitring PVC tile trims. Comes fully assembled with a super sharp forged steel blade and metal guide fence. Blade is lockable for safety and replacement blades are available.

- ✓ Heavy duty multi angle hand cutter ideal for cutting plastic tile trims, soft woods, rubber etc.
- ✓ Heavy duty steel construction.
- ✓ 7 pre-set angles for precise cuts.
- ✓ Non slip soft grip handles.
- ✓ Replaceable super sharp forged steel blade.



CODE	BARCODE	DESCRIPTION	REPLACEMENT BLADE
MRC160	5019788001609	mitre rite trim shear + guide	MRB149

HEAVY DUTY TILE SCRIBE



Designed to score a tile prior to breaking.

- ✓ Tungsten carbide chisel shaped scribe.
- ✓ Barrel width 6mm.
- ✓ Barrel length 130mm.
- ✓ Protective PVC Tip.

CODE	BARCODE	BARREL WIDTH	BARREL LENGTH
HCS058	5019788000589	6mm	130mm

TILE SCRIBE



Designed to score a tile prior to breaking.

- ✓ Solid tungsten tip.
- ✓ 120mm long round shaped barrel.
- ✓ Protective PVC tip.

CODE	BARCODE	SIZE	DESCRIPTION
STC502	5019788005027	120mm	round shaped barrel

TILE SAW WITH SOFT GRIP HANDLE



This deep frame tile saw is ideal for intricate cutting especially in mid tile areas.

- ✓ Comes complete with a 150mm (6") tough grit tungsten rod saw blade.
- ✓ Use to simplify the cutting and shaping of wall & floor ceramics up to 10mm thick.
- ✓ Frame allows a cutting depth of up to 110mm.
- ✓ Soft grip handle.

CODE	BARCODE	MAX TILE DEPTH	BLADE SIZE	FRAME DEPTH
SAW447	5019788004471	10mm	152mm (6")	110mm

6" TILE SAW



This extra deep frame tile saw is ideal for intricate cutting especially in mid tile areas.

- ✓ Comes complete with a 150mm (6") tough grit tungsten rod saw blade.
- ✓ Use to simplify the cutting and shaping of wall & floor ceramics up to 10mm thick.
- ✓ Frame allows a cutting depth of up to 125mm.
- ✓ Soft grip handle.

CODE	BARCODE	MAX TILE DEPTH	BLADE SIZE	FRAME DEPTH
TSS04	5019788005041	10mm	152mm (6")	125mm

UNDERCUT SAW



A must have tool used for removing the bottom of architraves, doors & door frames etc to allow tiles to slide underneath.

- ✓ Dual sided 305mm serrated steel tooth blade.

CODE	BARCODE	BLADE	DESCRIPTION
UCS084	5019788000848	305mm serrated steel tooth	undercut saw

HAND SCORE & SNAP WHEEL TILE CUTTER



200mm (8") tile pliers designed for scoring and snapping ceramic tiles.

- ✓ Suitable for Straight & Freehand Cuts.
- ✓ Simply Squeeze Handles Firmly Together to Break Tile.
- ✓ Black industrial breakers.
- ✓ Carbide cutting wheel: 13 x 6 x 1.3mm.

CODE	BARCODE	SIZE	WHEEL	DESCRIPTION
WTCS03	5019788000848	200mm (8 inches)	carbide 13x6x1.3mm	hand score & snap wheel tile cutter

250MM PLASTIC MITRE BOX



250mm plastic mitre box, ideal for use when cutting tile and bath trim to a 45 degree angle.

CODE	BARCODE	DESCRIPTION	SIZE
MBS43	5019788005430	Plastic mitre box	250mm

153MM METAL MITRE BOX

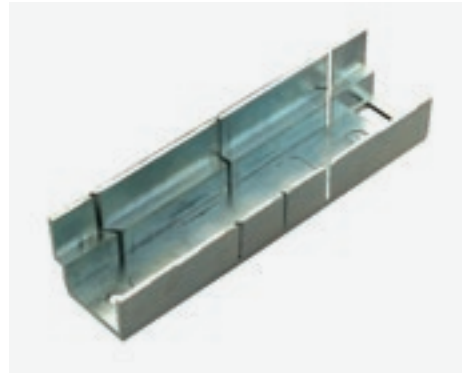

Pocket sized metal mitre box ideal for use when cutting tile and bath trims to a 45 deg angle.

CODE	BARCODE	DESCRIPTION	SIZE
MMB362	5019788003627	Metal mitre box	153mm x 37mm

2 TILE TRIMMERS

Made from tough aluminium oxide, these tile trimmers are designed to smooth sharp and uneven edges on a cut tile.

- ✓ Size: 180 x 65mm.
- ✓ 2 pcs per pack.



**GET FREE DELIVERY
ON ALL ORDERS
OVER £150
NETT**

(UK MAINLAND ONLY)



CODE	BARCODE	SIZE	DESCRIPTION
TTS37	5019788005379	180 x 65mm	tile trimmers

HANDLED TILE FILE



A coarse grit tungsten carbide half round file with plastic handle.

- ✓ Use for shaping and smoothing ceramic tiles and marble.
- ✓ Flat and curved faces for straight and contoured edges.

CODE	BARCODE	DESCRIPTION
HTF510	5019788005102	handled tile file

MITRE RITE SHEAR BLADE



Replacement blade for Tile Rite Mitre Shear Plus Guide MRG160.

- ✓ Pack contains 1 x Super Sharp forged steel blade.

CODE	BARCODE	BLADE	DESCRIPTION
MRB149	5019788001494	super sharp forged steel	mitre rite shear blade

6" DIAMOND GRIT SAW BLADE



Diamond grit blade suitable for use with 6" hacksaw frames TS504 & SAW447.

- ✓ Designed to cut difficult shapes from ceramic tiles & some porcelain.

CODE	BARCODE	SIZE	DESCRIPTION
DGB280	5019788002804	6 inches	diamond grit saw blade

TUNGSTEN GRIT ROD SAW BLADES



Tough tungsten grit rod saw blades ideal for cutting ceramic and glazed tiles

- ✓ Designed to cut difficult shapes from ceramic tiles & similar material.
- ✓ Suitable for use with hacksaw frames.

CODE	BARCODE	SIZE	DESCRIPTION
TSB505	5019788005058	152mm (6")	saw blade
TSB516	5019788005164	305mm (12")	saw blade
TSB517	5019788005171	254mm (10")	saw blade

BOSCH TYPE JIGSAW BLADE



Designed to cut difficult shapes from ceramic tiles & similar materials.

- ✓ Suitable for; Bosch, AEG, ELU, Festo, Hitachi, Holzer & Makita.
- ✓ 76mm Tungsten grit blade.

CODE	BARCODE	BLADE	DESCRIPTION
JB0562	5019788005621	76mm tungsten grit	bosch type jigsaw blade

BLACK & DECKER TYPE JIGSAW BLADE



Designed for the precision cutting of ceramic tiles & similar materials.

- ✓ Suitable for Black & Decker type / Universal.
- ✓ 73mm tungsten grit blade.

CODE	BARCODE	SIZE	DESCRIPTION
JBL561	5019788005614	73mm	black and decker type jigsaw blade

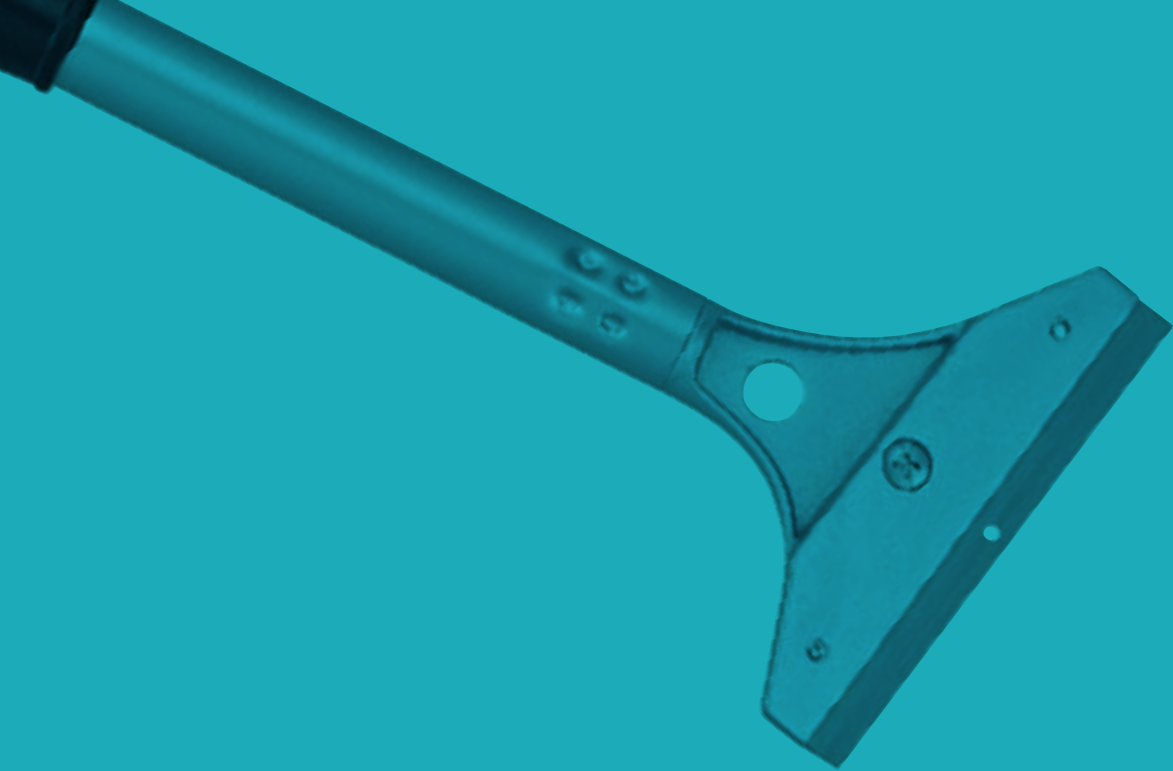

GENERAL TILING TOOLS

**TILE RITE TILING TOOLS
ARE DESIGNED FOR
BOTH THE DIY AND
PROFESSIONAL TILE
FIXER, ALL OF OUR
TILING TOOLS ARE
DESIGNED TO MAKE
TILING JOBS SIMPLE.**

Our general tiling tools section covers grout
& tile removal tools, measuring tools, silicone
tools and miscellaneous tiling tools.

In this section

- ✓ Grout Removal Tools.
- ✓ Scrapers.
- ✓ Measuring & Marking.
- ✓ Silicone Tools.
- ✓ Miscellaneous Tools.



ELECTRIC GROUT REMOVER

FOR MORE INFORMATION OR TO ORDER
CALL US ON: 01543 500 893

GENERAL TILING TOOLS



Fast, versatile grout removing tool for refreshing any tiled area.

- ✓ 3 speed pneumatic action powers through old and discoloured grouts.
- ✓ 2 x Interchangeable grout removing tips included.
- ✓ 2.5m power cable allows a greater working area.
- ✓ Replacement tips available (EGRR-182).



CODE	BARCODE	POWER CABLE	POWER	POWER SUPPLY	MAX STROKE	BIT DIA:	REPLACEMENT TIPS
EGR048	5019788000480	2.5M	0.2A (13W)	120V~60Hz	7100 min-1	3.2mm	EGRR182

ELECTRIC GROUT REMOVER REPLACEMENT TIPS

2 x Replacement tips for use with Tile Rite Electric Grout Remover (EGR048).

- ✓ 1 x Chisel Head 3mm.
- ✓ 1 x Spear Head.
- ✓ 1 x Alan Key.

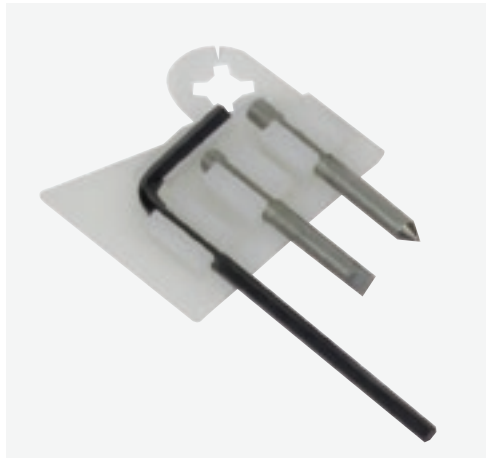

CODE	BARCODE
EGRR 182	5019788001821

GROUT RAKE (COMFORT GRIP)



Designed to remove old & discoloured grout from between tile joints.

- ✓ Replaceable blades.
- ✓ 1 x serrated steel tooth blade.
- ✓ 1 x tungsten carbide grit blade.
- ✓ Replacement Blade: GRBC.

CODE	BARCODE	REPLACEMENT BLADE
GRC364	5019788003641	GRBC

GROUT RAKE BLADES (COMFORT GRIP)



2 Piece replacement kit for use with Tile Rite grout rake GRC364.

- ✓ 1pc carbide grit blade.
- ✓ 1pc tooth steel blade.

CODE	BARCODE	SIZE
GRBC	5019788005546	50mm

GROUT RAKE



Designed to remove old & discoloured grout from between tile joints.

- ✓ Replaceable blades.
- ✓ 1 x serrated steel tooth blade.
- ✓ 1 x tungsten carbide grit blade.



CODE	BARCODE	REPLACEMENT BLADE
GR518	5019788005188	GRB522

GROUT RAKE BLADES



2 Piece replacement kit for use with Tile Rite grout rake GR518.

- ✓ 1pc carbide grit blade.
- ✓ 1pc tooth steel blade.

CODE	BARCODE	SIZE
GRB522	5019788005225	50mm



FOR MORE INFORMATION OR TO ORDER
CALL US ON: 01543 500 893

GENERAL TILING TOOLS

GROUT FINISHER

Dual purpose plastic grout finisher / adhesive remover.

- ✓ Plastic blade to remove excess adhesive.
- ✓ Round end to smooth grout lines for a professional finish.



CODE	BARCODE
GFR563	5019788005638

152MM WALL SCRAPER



Removes adhesive, grout, wallpaper & paint.

- ✓ Replaceable high carbon super sharp steel blade.
- ✓ 152mm (6") blade.
- ✓ Replacement Blade - WSB072 (5 pcs).

WALL SCRAPER BLADES 152MM



Replacement scraper blades for use with Tile Rite scraper WS545.

- ✓ Super sharp high carbon steel blade 152mm (6").
- ✓ Contains 5 pieces.

CODE	BARCODE	BLADE	REPLACEMENT BLADE
WS545	5019788005454	6 inches sharp steel	WSB072

CODE	BARCODE	SIZE	DESCRIPTION
WSB072	5019788000725	152mm (6 inches)	wall scraper blade

4" TILE REMOVER / SCRAPER



Professional quality tile remover ideal for removing tiles & adhesive from wall displays, showers & splashbacks.

- ✓ Rubber contoured handle with steel cap for extra strength.
- ✓ 100mm (1.2mm thick) Stainless Steel blade, bent for extra leverage.
- ✓ Stainless steel blade with cutting edge.



GET FREE DELIVERY
ON ALL ORDERS
OVER £150
NETT

(UK MAINLAND ONLY)



CODE	BARCODE	BLADE THICKNESS	BLADE WIDTH
TRS440	5019788004402	1.2mm	100mm

CHINAGRAPH MARKER



Red & Black Paper wrapped wax markers for use on tiles, glass, china, acetate and other high gloss surfaces. Use for marking dimensions or drilling positions.

- ✓ Water resistant (lines will not bleed).
- ✓ No sharpening required.

CODE	BARCODE	PACK SIZE
CHM365	5019788003658	2 pcs

CHALK LINE KIT



A handy tool which creates a crisp, perfectly straight line in the blink of an eye.

No other tool, except an expensive laser, makes a perfectly straight line over a long distance so quickly and reliably.

- ✓ 110g blue chalk refill.
- ✓ Line Level.
- ✓ 15m chalk line reel.

CODE	BARCODE	LENGTH	WEIGHT
CHA354	5019788003542	15m	110g

5M STEEL MEASURING TAPE



Professional Quality 5m Nylon Coated Steel Tape Measure.

- ✓ Comfort grip outer.
- ✓ Vertical & horizontal quick thumb & finger hold button.
- ✓ Fully lockable with quick retraction.
- ✓ Belt clip & Lanyard.
- ✓ Measurements in mm/cm & inch/Feet.

CODE	BARCODE	LENGTH
FMT832	5019788008325	5m

BASIC TAPE MEASURE



5m Steel Tape Measure.

- ✓ Blue & White plastic case.
- ✓ Belt Clip.
- ✓ Measurements in mm/cm & inch/Feet.

CODE	BARCODE	LENGTH
BTM889	5019788008899	5m

CHROME PLATED HALF BARREL FRAME CAULKING GUN

Chrome plated half barrel frame caulking gun for dispensing 310ml cartridges. With a thrust ratio of 6:1 for use with medium viscosity materials.

- ✓ Ratchet style pressure rod for minimising drips.
- ✓ Welded plate in back for securing cartridge in place.
- ✓ Hanging hook and wrist strap.
- ✓ Seal puncture tool.
- ✓ Spout cutter.



CODE	BARCODE	CARTRIDGE	THRUST RATIO	USE WITH
GUN446	5019788004464	310ml	6 : 1	medium viscosity materials

2 PIECE SILICONE APPLICATOR SET



This professional seal smoother, smooths, models & removes silicone, acrylic & SMP sealants for a professional neat finish.

- ✓ Ideal for baths, showers, basins, window sills, aquariums & balconies etc.
- ✓ Easy to use tool, no need to tape or mask joints.
- ✓ Pack contains 2 seal smoothers to create a quadrant or triangular seal.

CODE	BARCODE
PSS246	5019788002460

LONG HANDLE SILICONE FINISHER



Designed to shape silicone sealant for a perfect neat finish.

- ✓ Long handle for hard to reach areas such as behind taps etc.

CODE	BARCODE	SIZE
SFS289	5019788002897	22mm
SFL288	5019788002880	35mm

SEALANT REMOVER



Designed to strip away old & discoloured silicone or acrylic sealant.

- ✓ Stainless Steel two-way stripping blade.
- ✓ Comfort grip handle.

CODE	BARCODE	BLADE
TSR252	5019788002521	STAINLESS STEEL



FOR MORE INFORMATION OR TO ORDER
CALL US ON: 01543 500 893

GENERAL TILING TOOLS

5" CONTOUR GAUGE



Simply press the contour gauge around pipework or architraves to trace the shape, then transfer to the tile.

- ✓ Ideal for fitting tiles, laying carpet, checking, dimensions, measuring mouldings etc.
- ✓ 127mm long.

CODE	BARCODE	LENGTH
TCG120	5019788001203	127mm

TILERS PROFESSIONAL GEL KNEE PADS



Anti-compression air injected GEL for comfort and protection against rough surfaces.

- ✓ Foam core gives maximum cushioning.
- ✓ Perforated neoprene lining keeps away moisture.
- ✓ Constructed from heavy duty 600D polyester fabric.
- ✓ Velcro straps secure below knee for stability & comfort.
- ✓ Pack contains one pair - One size.

WOULD YOU LIKE TO KNOW MORE?

CALL US TODAY ON:

01543 500 893



CODE	BARCODE
GKP273	5019788002736

ACCESS PANEL MAGNETS

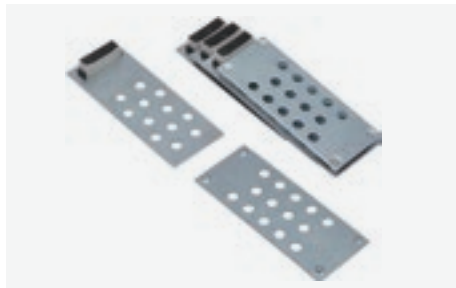

Tile Rite Access Panel Magnets are the ideal system for creating concealed panels in tiled wall coverings.

Use where access to electrical or plumbing components are necessary.

- ✓ This assembly kit consists of 4 x aluminium brackets containing magnets and 4 x metal counter plates.
- ✓ If the access opening is substantially larger than 30x30cm it may be necessary to install 2 x additional magnets.

CODE	BARCODE
MAG439	5019788004396

RUBBER Mallet



Solid 12oz non-marking rubber mallet, for general use where non-marking of a surface is critical.

- ✓ White rubber head to prevent marking.
- ✓ Smooth wooden handle.
- ✓ Use for tapping tiles level.

CODE	BARCODE	WEIGHT
RMB233	5019788002330	12oz (0.34kg)

SPIKED ROLLER



Suitable for rolling out air bubbles, levelling & moving epoxy coatings, self-levellers and pumped screeds.

- ✓ 30mm spikes.
- ✓ Width: 760mm.

CODE	BARCODE	WIDTH	SPIKES
SPR326	5019788003269	760mm	30mm

SPIKED SCREEDING SHOES



A professional 13 spiked tiling shoe that can be strapped to footwear.

Enables the user to walk on screeding, resin floors, self-levelling compounds and adhesives etc during application without disturbing the laid surface.

- ✓ 30mm spikes.
- ✓ One Size; Adjustable Velcro straps.

CODE	BARCODE	SIZE
TSH325	5019788003252	one size



FOR MORE INFORMATION OR TO ORDER
CALL US ON: 01543 500 893

ADHESIVE TROWELS

84

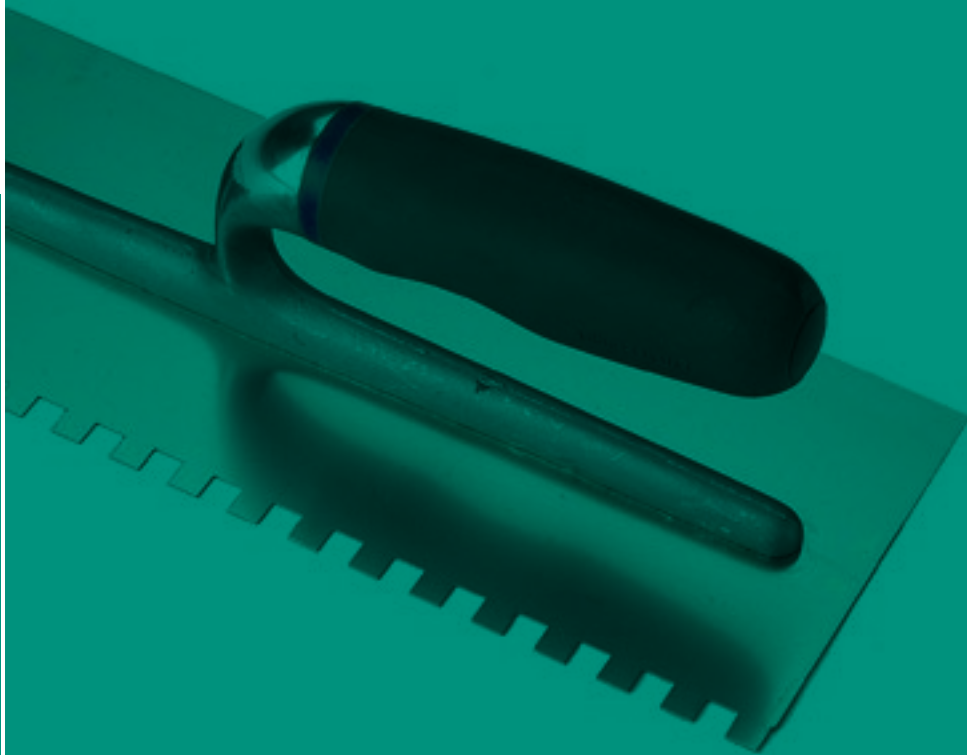

ADHESIVE TROWELS

TILE RITE OFFER A RANGE OF ADHESIVE TROWELS WITH CARBON STEEL, HIGH CARBON STEEL & STAINLESS-STEEL BLADES AND 3 HANDLE TYPES, PLASTIC, WOOD AND COMFORT GRIP TO SUIT ALL BUDGETS AND PREFERENCES.

A general guide to notched trowels

The mm size of the notch roughly equates to the inches of tile being fitted plus another 2 inches (for example 6mm notch = 6-8 inch tile). This general rule of thumb, can change according to the surface you are tiling onto. If the surface is not flat then you can increase the notch to the next size up.

3mm trowels are often used for fixing mosaic tiles as this produces a very thin bed of adhesive which means that there is less chance of the adhesive coming through the tiles when fixing.

For floor tiling a minimum of 10mm trowels would be used to ensure there is enough contact on the back of the tile to eliminate voids. It is always better to use a larger trowel than you might need, as more adhesive beneath the tile is completely acceptable, whereas not enough adhesive is not.

When trowelling your adhesive make sure you trowel at an angle of 45 degrees and press hard scraping the wall or floor only to leave the notch of adhesive. When placing a tile move it out 5mm then back to make sure your adhesive gets a good contact with the tile.

Within this section

- ✓ Stainless Steel Trowels.
- ✓ Professional Carbon Steel Trowels.
- ✓ Economy Steel Trowels.
- ✓ Adhesive Spreaders.
- ✓ Bucket Trowels.

STAINLESS STEEL TROWELS

6 x 6 x 6mm



Tile Rite square notched trowels are used for laying down tile adhesive ready for tiling.

The Stainless-Steel blade is rust and corrosion resistant offering tilers a reliable and durable option. Cast aluminium handle is 6 spot rivet mounted and finished with a U curved comfort grip.

8 x 8 x 8mm



10 x 10 x 10mm



12 x 12 x 12mm



12mm



CODE	BARCODE	BLADE SIZE	NOTCH TYPE	SQUARE NOTCH	COMMON USEAGE
SST146	5019788001463	280 x 115mm	square	6 x 6 x 6mm	fixing 6-8 inch wall tiles
MST147	5019788001470	280 x 115mm	square	8 x 8 x 8mm	fixing 8-10 inch wall or floor tiles
TSS703	5019788007038	280 x 115mm	square	10 x 10 x 10mm	fixing 10-12 inch wall or floor tiles
LST148	5019788001487	280 x 115mm	square	12 x 12 x 12mm	fixing 12 inch tiles or over
VSS324	5019788003245	280 x 115mm	v notch	12mm	fixing 12 inch tiles or over



HIGH CARBON STEEL SQUARE NOTCH TROWELS

4 x 4 x 4mm



Tile Rite square notched trowels are used for laying down tile adhesive ready for tiling.

The high carbon steel blade is highly durable and retains its shape & notched edges well. Cast aluminium handle is 6 spot rivet mounted and finished with a U curved smooth wooden grip.

6 x 6 x 6mm



8 x 8 x 8mm



10 x 10 x 10mm



12 x 12 x 12mm



CODE	BARCODE	BLADE SIZE	NOTCH TYPE	NOTCH SIZE	COMMON USAGE
DBT699	5019788006994	280 x 115mm	square	4 x 4 x 4mm	fixing 4-6 inch wall tiles & durabase
SNT521	5019788005218	280 x 115mm	square	6 x 6 x 6mm	fixing 6-8 inch wall tiles
MNT144	5019788001449	280 x 115mm	square	8 x 8 x 8mm	fixing 8-10 inch wall or floor tiles
TNT704	5019788007045	280 x 115mm	square	10 x 10 x 10mm	fixing 10-12 inch wall or floor tiles
LNT523	5019788005232	280 x 115mm	square	12 x 12 x 12mm	fixing 12 inch tiles or over

FOR MORE INFORMATION OR TO ORDER
CALL US ON: 01543 500 893

ADHESIVE TROWELS

HIGH CARBON STEEL TIGER NOTCH TROWEL

The Tiger trowel is a dual depth trowel offering 100% adhesive coverage. Suitable for use when fixing 300x300mm (12") tiles and over and ideal with flexible adhesive and fixing tiles in wet areas.

The unique notch design allows for easier bedding of tiles and reduces the need to 'back butter'.

- ✓ Dual depth trowel offering 100% adhesive coverage.
- ✓ Suitable when fixing 300x300mm tiles and over.
- ✓ Ideal for use with flexible tile adhesive & fixing tiles in wet areas.
- ✓ The unique notch design allows for easier bedding of tiles and reduces the need to 'back butter'.
- ✓ Aluminium handle with wood grip.



CODE	BARCODE	BLADE SIZE	NOTCH TYPE	COMMON USAGE
TIG688	5019788006888	280 x 115mm	tiger dual depth	fixing tiles 300x300mm and over

HIGH CARBON STEEL ROUND NOTCH TROWELS

U notched trowels create a U-shaped ridge in the tile adhesive, this causes the adhesive to spread out from the bottom when embedding a tile, so the probability of trapping air is less, thus ensuring a better coverage beneath the tile.

This makes the U notch trowels a preferred choice when tiling in wet areas where the adhesive coverage should be between 95-100%.

U notched trowels also make it easier to keep adhesive out of the grout lines as you embed the tile.



CODE	BARCODE	BLADE SIZE	NOTCH TYPE	NOTCH SIZE	COMMON USAGE
MT145	5019788001456	280 x 115mm	u notch	3.2 x 3.2 x 4.8mm	fixing mosaic or small module wall tiles
SRNT526	5019788005263	280 x 115mm	u notch	6 x 6 x 8mm	fixing most wall tiles in wet areas
RNT529	5019788005294	280 x 115mm	u notch	9.5 x 19.2 x 10mm	fixing most floor tiles & natural tiles



FOR MORE INFORMATION OR TO ORDER
CALL US ON: 01543 500 893

ADHESIVE TROWELS

ECONOMY STEEL SERIES ADHESIVE TROWELS

6mm



8mm



10mm



12mm



TILE RITE TILING TIPS

With this screw mounted handle you can easily remove and reverse the blade to create a left handed trowel!



CODE	BARCODE	BLADE SIZE	NOTCH TYPE	NOTCH SIZE	COMMON USEAGE
ENS123	5019788001234	230 x 100mm	square	6 x 6 x 6mm	fixing 6-8 inch wall tiles
ENM119	5019788001197	230 x 100mm	square	8 x 8 x 8mm	fixing 8-10 inch wall or floor tiles
ENP113	5019788001135	230 x 100mm	square	10 x 10 x 10mm	fixing 10-12 inch wall or floor tiles
ENT122	5019788001227	230 x 100mm	square	12 x 12 x 12mm	fixing 12 inch tiles or over

4MM V NOTCH TROWEL



The V notch trowel is great for creating a thin solid bed of adhesive and is typically used with mosaic tiles as they dispense less mortar so it's easier to keep adhesive out of grout joints when embedding the tiles. Also ideal for spreading adhesive for vinyl flooring.

CODE	BARCODE	BLADE SIZE	NOTCH TYPE	NOTCH SIZE
ENV124	501978801241	230 x 100mm	v notch	5mm

PLASTER HAWK

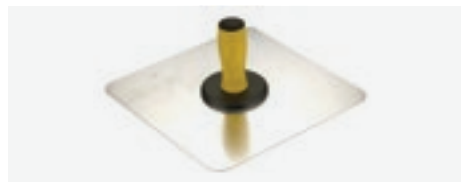

- ✓ Made from heavy gauge hard-rolled aluminium.
- ✓ Smooth straight edges with rounded corners.
- ✓ 95mm flange with extended hub that is threaded for the handle.
- ✓ 125mm Detachable durasoft handle with a sponge rubber callous preventer included.

CODE	BARCODE	SIZE
PHAW323	5019788003238	300x300mm

PLASTER TROWEL



A short trowel that achieves a flat and even finish. The Stainless-Steel blade is rust and corrosion resistant offering a reliable and durable option.

- ✓ For use on finishing plaster.
- ✓ Wide flat trowel with straight edges.
- ✓ Plastic handle with comfort grip.

CODE	BARCODE	SIZE
SPT321	5019788003214	280x125mm

DUAL NOTCH PLASTIC TROWEL



With 6mm notches ideal for spreading adhesive for 6-8-inch wall tiles on to smooth surfaces in dry areas, and 10x20mm round notches suitable for most flooring applications creating a thick solid bed. The plastic trowel is ideal for underfloor heating applications as it will not damage the wires.

CODE	BARCODE	BLADE SIZE	NOTCH TYPE	NOTCH SIZE	COMMON USAGE
DNP797	5019788007977	280 x 115mm	v type / u notch	6mm / 20mm	ideal with underfloor heating

BLACK ADHESIVE SPREADER



With 10mm wide and 5mm deep square notches, this little adhesive spreader is ideal for fast adhesive application ideal for small wall tiling jobs or repair jobs.

CODE	BARCODE	SIZE	NOTCH TYPE	NOTCH SIZE	COMMON USAGE
AS501	5019788005010	110mm	square	10x10x5mm	small wall tile repair jobs

RED FLOOR ADHESIVE SPREADER



Creates a solid bed fixing suitable for small tiling jobs when spreading adhesive in wet areas. Also suitable for spreading adhesive for vinyl flooring.

CODE	BARCODE	SIZE	NOTCH TYPE	NOTCH SIZE	COMMON USAGE
FAS511	5019788005119	152mm	dual depth	4x3 x 4mm	small tile repair jobs

JUNIOR SQUARE NOTCHED ADHESIVE SPREADER

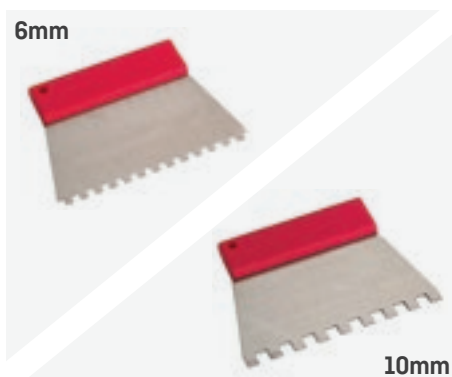

These handy spreaders with flexible steel blade are for fast adhesive application and ideal for small wall tiling jobs or repair jobs. 6mm notched trowel ideal for fixing 6-8-inch wall tiles and 10mm ideal for 10-12 inch wall or floor tiles.

CODE	BARCODE	SIZE	NOTCH TYPE	NOTCH SIZE	COMMON USAGE
J55127	5019788001272	175mm	square	6mm	fixing 6-8-inch wall tiles
J5126	5019788001265	170mm	square	10mm	fixing 10-12-inch wall tiles



FOR MORE INFORMATION OR TO ORDER
CALL US ON: 01543 500 893

ADHESIVE TROWELS

GAUGING TROWEL



The Gauging trowel has a rounded tip and a v-shaped back. It is used for gauging, or mixing in specific proportions, typically when you desire to mix small amounts of a quick-setting thin set, mortar, or drywall compound.

- ✓ Specialist trowel for gauging application of wall adhesive prior to serration.
- ✓ High carbon stiff steel blade.
- ✓ Aluminium handle with wood grip.

CODE	BARCODE	SIZE
GT525	5019788005256	178mm

LARGE BUCKET TROWEL



The tilers flat bottomed bucket trowel is used to remove unmixed and unused adhesive from the side of a mixing bucket. The flat nose ensures that it gets right into the corners of the mixing bucket to shift the unmixed compound that a mixer cannot reach.

- ✓ High carbon steel blade.
- ✓ Aluminium handle with wood grip.

CODE	BARCODE	SIZE
LBT276	50197880012767	200x88mm

SMALL BUCKET TROWEL



Tilers flat bottomed bucket trowel used for removing grout and adhesives from the base of a bucket.

- ✓ High carbon stiff steel blade.
- ✓ Aluminium handle with wood grip.
- ✓ Dimensions 127 x 60mm.

CODE	BARCODE	SIZE
BT135	5019788001357	127x50mm

6MM SQUARE NOTCHED MARGIN TROWEL



Ideally used for the application of tile adhesive in restricted areas and corners. The 6mm square notches create a suitable bed for 6-8-inch wall tiles on to smooth surfaces in dry areas.

- ✓ High carbon steel blade.
- ✓ Aluminium handle with wood grip.

CODE	BARCODE	SIZE	NOTCH TYPE	NOTCH SIZE	COMMON USAGE
SMT125	50197880012645	44 x 116mm	square	6mm	fixing 6-8-inch wall tiles



GROUT FLOATS & SPREADERS

GROUT FLOATS AND SPREADERS ARE SPECIALLY DESIGNED FOR THE FINISHING OF GROUT JOINTS.

Tile Rite offer a range of floats to suit your tiling needs.

Our solid rubber floats are ideal for use with sand & cement, epoxy or acrylic grouts.

Our foam backed floats are designed to be ergonomic, lightweight and comfortable for regular use.

Our pointed, tapered and mini floats are great for hard to reach areas or awkward recesses.

We also have DIY spreaders for small repair jobs, and grout bags ideal when grout needs to be directed straight in to the joints.

Within this section

- ✓ Grout Floats.
- ✓ Floats and Spreaders.



FOR MORE INFORMATION OR TO ORDER
CALL US ON: 01543 500 893

GROUT FLOATS & SPREADERS

RITE GROUT FLOAT



Lightweight float for wall & floor tile grouting.

- ✓ Easy to clean and durable.
- ✓ White face bonded to a dense rubber foam.
- ✓ Plastic handle.
- ✓ Size: 230 x 80mm.

CODE	BARCODE	SIZE
PGF531	5019788008317	230x80mm

TAPERED GROUT FLOAT



Lightweight tapered float for use on walls & floors when grouting in awkward or narrow recesses.

- ✓ Easy to clean and durable.
- ✓ White face bonded to a dense rubber foam.
- ✓ Plastic handle.
- ✓ Size: 65 x 270 x 100mm.

CODE	BARCODE	SIZE
VGF161	5019788001616	65x270x100mm

EPOXY GROUT FLOAT

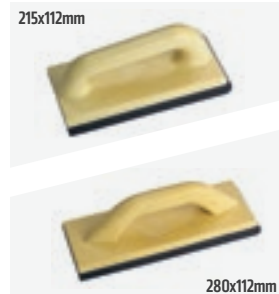

Professional Epoxy Grout Float

- ✓ Can be used with epoxy or acrylic grouts.
- ✓ One-piece plastic handle.
- ✓ Lightweight for ease of spreading.
- ✓ Black rubber face with rounded & beveled edges.

CODE	BARCODE	SIZE
GF534	5019788005348	215x112mm
GF535	5019788005355	280x112mm

MARSHALLTOWN GROUT FLOAT WHITE

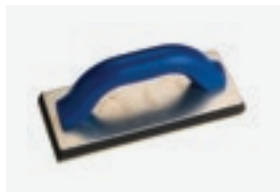

Professional lightweight float specifically designed for wall & floor tile grouting.

- ✓ Pure white gum rubber face bonded to a dense rubber pad.
- ✓ Aluminium backing.
- ✓ Smooth plastic handle.
- ✓ Rounded & beveled edges for ease of spreading.
- ✓ Size: 229 x 102mm.

CODE	BARCODE	SIZE
MGF43	3596504422	229x102mm

MARSHALLTOWN GROUT FLOAT BLACK

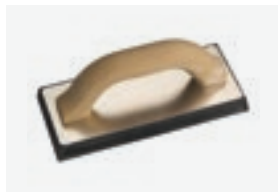

Professional lightweight float specifically designed for grouting floor tiles when using epoxy resin, sand & cement.

- ✓ Black textured face.
- ✓ Aluminium backing.
- ✓ Smooth plastic handle.
- ✓ Rounded & beveled edges for ease of spreading.
- ✓ Size: 229 x 102mm.

CODE	BARCODE	SIZE
MGF528	3596504408	229x102mm

POINTED GROUT FLOAT



Lightweight pointed float for precision grouting (wall & floor).

- ✓ Ideal for use on internal corners.
- ✓ White face bonded to a dense rubber foam.
- ✓ Aluminium backing.
- ✓ Plastic handle.
- ✓ Size: 280 x 80mm.

CODE	BARCODE	SIZE
PRF185	5019788001852	280x80mm

FOAM GROUT FLOAT



DIY lightweight grout float Ideal for use when grouting mosaics.

- ✓ One-piece plastic handle.
- ✓ Foam pad.
- ✓ Size: 280 x 112mm.

CODE	BARCODE	SIZE
FGF320	5019788003207	280x112mm

RITE CORNER FLOAT



A handy mini grout float ideal when grouting in hard to reach areas such as behind radiators etc.

- ✓ Lightweight and easy to use.
- ✓ White gum rubber face bonded to a dense rubber pad.
- ✓ Aluminium backing.
- ✓ Wood open grip handle.
- ✓ Size: 127 x 65mm.

CODE	BARCODE	SIZE
CF187	5019788001876	127x65mm

GROUT BAG



Designed for the clean and easy application of grout

- ✓ Less mess than conventional grouting as it enables grout to be directed into tile joints with less need for cleaning.
- ✓ Ideal for riven tiles or tile surfaces that are hard to clean.
- ✓ Bag fully washable & reusable.

CODE	BARCODE	SIZE
TG8277	5019788002774	125mm

8" GROUT SPREADER

G5508



200mm black flexible rubber blade for grout spreading.

- ✓ Available with wooden or plastic handle.

CODE	BARCODE	SIZE
G5508	5019788005089	200mm
G5508R	5019788005089	200mm

TILE RITE COMBINATION SPREADER



6mm square notched edge for adhesive application.

- ✓ Black flexible rubber blade for grout spreading.
- ✓ Measurements in mm & inches.
- ✓ Integral euro hanger to eliminate packaging waste.
- ✓ Size: 125mm.

CODE	BARCODE	SIZE
TC5444	5019788004440	125mm

DUAL PURPOSE SPREADER



Tough dual-purpose adhesive / grout spreader.

- ✓ 10 x 5 notched plastic handle for adhesive application.
- ✓ 178mm flexible white rubber blade for grout spreading.

CODE	BARCODE	SIZE	NOTCH
DP5553	5019788005539	178mm	10x5mm



FOR MORE INFORMATION OR TO ORDER
CALL US ON: 01543 500 893

GROUT CLEANING



GROUT CLEANING

TILE RITE OFFER A RANGE OF TOOLS SPECIALLY DESIGNED FOR CLEANING UP AFTER TILE INSTALLATIONS.

Washboys are great when cleaning up large tiled areas, the 23litre bucket has a metal or plastic grid, this decants the excess grout and leaves clean water above it to clean your sponge. The rollers remove excess water from your float, so you don't end up soaking your grout joints!

Our coarse emulsifying pads are great for removing stubborn films, stains & grout residue and our white emulsifying pads are great for cleaning & polishing.

We also offer a variety of specially formulated sponges to suit your preferences.

Within this section

- ✓ Washboy Sets & Accessories.
- ✓ Emulsifying Pads & Accessories.
- ✓ Squeegees.
- ✓ Sponges.

WASHBOY SET C

Makes cleaning off excess wall & floor grout from tile installations quick & easy.

- ✓ 23 Litre black plastic bucket with wheel castors.
- ✓ Grip moulded handle.
- ✓ Heavy duty twin roller system.
- ✓ 1 x segmented sponge float (285 x 140 x 30mm).
- ✓ 1 x removable plastic grid.



CODE	BARCODE	SIZE
WBS231	5019788002316	23 litres

PROFESSIONAL WASHBOY SET

Makes cleaning off excess wall & floor grout from tile installations quick & easy

- ✓ 23 Litre red plastic bucket with wheel castors.
- ✓ Grip moulded handle.
- ✓ Heavy duty triple roller system.
- ✓ 1 x segmented sponge float (285 x 140 x 30mm).
- ✓ 1 x removable metal grid.



CODE	BARCODE	SIZE
PWS366	5019788003665	23 litres

WASHBOY FLOAT



- ✓ Plastic one-piece handle with segmented sponge float.
- ✓ Segmented sponge follows surface contours effectively.
- ✓ Replacement pad code: RHS703.

CODE	BARCODE	SIZE
SCS232	5019788002323	285x140x30mm

REPLACEMENT WASHBOY SPONGE



- ✓ Hydro sponge designed to retain less water so will not soak grout joints.
- ✓ Segmented sponge follows surface contours effectively.
- ✓ Adhere to handle with spray mount adhesive or similar.

CODE	BARCODE	SIZE
RHS073	5019788000732	285x140x30mm



FOR MORE INFORMATION OR TO ORDER
CALL US ON: 01543 500 893

GROUT CLEANING

VELCRO WASHBOY FLOAT



- ✓ Plastic handle with non-blister comfort grip handle.
- ✓ Velcro backed segmented sponge, follows surface contours effectively.

CODE	BARCODE	SIZE
VWF358	5019788003580	285x140x30mm

VELCRO WASHBOY FLOAT REPLACEMENT PAD



- ✓ Velcro backed segmented sponge, follows surface contours effectively.
- ✓ Use with VWF358.

CODE	BARCODE	SIZE
VWFR359	5019788003597	285x140x30mm

PROFESSIONAL EMULSIFYING PADS



Tile Rite Professional emulsifying pads will greatly increase the ease of removing stains, or ingrained dirt from tiles in bathrooms, wet rooms and kitchens.

Fully chemical resistant so can be used with all specialist tile & stone cleaning products.

- ✓ 1 x durable plastic handle & backing with Velcro grippers (228x110mm).
- ✓ 1 x White smooth nonabrasive pad ideal for light cleaning & polishing (250 x 120mm).
- ✓ 1 x Black abrasive pad ideal for removing stubborn films & grout residue (250 x 120mm).



CODE	BARCODE	TYPE	SIZE
EMP165	5019788001654	complete set	250x120mm
SPC183	5019788001838	coarse pad	250x120mm
SPS184	5019788001845	smooth pad	250x120mm

DIY EMULSIFYING PAD COARSE



Used to aid removal of stubborn dirt & stains from tiles including grout & epoxy grout.

- ✓ Ideal for removing stubborn films & grout residue.
- ✓ Chemical resistant can be used with specialist tile & stone cleaning products.
- ✓ All in one emulsifying pad with plastic handle - Coarse.
- ✓ Size: 150 x 90mm.

CODE	BARCODE	TYPE	SIZE
EPC180	5019788001807	coarse	150x90mm

DIY EMULSIFYING PAD SMOOTH

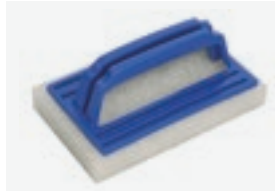

Used to aid removal of stubborn dirt & stains from tiles.

- ✓ White smooth nonabrasive pad ideal for light cleaning & polishing.
- ✓ Chemical resistant can be used with specialist tile & stone cleaning products.
- ✓ All in one emulsifying pad with plastic handle - Smooth.
- ✓ Size: 150 x 90mm.

CODE	BARCODE	TYPE	SIZE
EPS181	5019788001814	smooth	150x90mm

60MM GROUT SCRUBBING BRUSH



Use to scrub and clean grout lines between tiles.

- ✓ Thick durable nylon bristles that will clean corners and grout lines.
- ✓ Curved handle design allows cleaning in hard to reach places.
- ✓ Total length is 7" (178mm).

CODE	BARCODE	SIZE
GS8046	5019788000466	7" (178mm)

FOAM FLOOR SQUEEGEE 55CM

55cm Double heavy-duty foam floor squeegee for use in moving large volumes of water, mud, debris, waste, scraps, slush or snow and flood clean-up.

- ✓ Offers clean-up for variety of surfaces and applications, from building clean-up to facility maintenance to flood damage. Great around the house for decks, patios and garage floors.
- ✓ Use on coated and uncoated smooth concrete floors, asphalt, grouted & tiled floors and other smooth surfaces.
- ✓ Superior for spreading sealers and coatings.
- ✓ Clamp style attachment for fixing a tapered wooden handle or similar.
- ✓ Handle not included.



CODE	BARCODE	SIZE
TGS278	5019788002781	55cm



FOR MORE INFORMATION OR TO ORDER
CALL US ON: 01543 500 893

GROUT CLEANING

DUAL PURPOSE SPONGE



Dual sided sponge used for cleaning tiles after grouting.

- ✓ Coarse side useful for cleaning off stubborn grout.
- ✓ Smooth side for polishing.
- ✓ Rounded edges.
- ✓ Size: 160 x 120 x 50mm.

CODE	BARCODE	SIZE
GCS312	5019788003122	160x120x50mm

PRO GROUTING SPONGE



Used for grouting and cleaning up grout.

- ✓ Hydro sponge designed for less water retention as not to saturate grout lines.
- ✓ Lightweight for ease of spreading.
- ✓ Size: 175 x 105 x 60mm.

CODE	BARCODE	SIZE
PGS555	5019788005553	175x105x60mm

PRO HYDRO SPONGE



Specially formulated hydro sponge to remove excess grout from tiles.

- ✓ Retains less water so will not soak grout joints.
- ✓ Clean off excess grout as work proceeds.
- ✓ Dimensions: 175 x 105 x 60mm.

CODE	BARCODE	SIZE
PHS360	5019788003603	175x105x60mm

LARGE FLOOR SPONGE



Used for cleaning up after grouting.

- ✓ Size: 190 x 140 x 60mm.

CODE	BARCODE	SIZE
PSC162	5019788001623	190x140x60mm

DIY TILE SPONGE



Used for cleaning up after grouting.

- ✓ Size: 150 x 95 x 55mm.

CODE	BARCODE	SIZE
TCS532	5019788005324	150x95x55mm

DID YOU KNOW?

ALL OF OUR SPONGES ARE SPECIALLY FORMULATED TO RETAIN LESS WATER SO THAT GROUT LINES DON'T BECOME TOO SATURATED.





CLEAN & SEAL RANGE

MOST TILES REQUIRE CLEANING PRIOR TO SEALING, THIS ENSURES THAT THE TILES ARE IN OPTIMUM CONDITION BEFORE THEY ARE SEALED.

Tile Rite supply a range of cleaners for different applications from removing mould & blackspots to removing heavy duty specialist coatings such as acrylic & polyurethane.

Most natural tiles are porous and need to be sealed to prevent staining. Seal prior to grouting to protect against grout stains. Apply a further 1-2 coats of sealer after installation to prevent every day stains & spills.

Tile Rite offer a variety of sealing solutions, as a general rule, use a solvent based impregnator for polished or finely-honed surfaces and a water-based impregnator for porous tiles.

Within this section

- ✓ Cleaning Products.
- ✓ Sealing Products.



FOR MORE INFORMATION OR TO ORDER
CALL US ON: 01543 500 893

CLEAN & SEAL RANGE

EASY CLEAN

Tile Rite Easy Clean pH-Neutral Tile Cleaner.

It's a safe multipurpose cleaner developed for use on Ceramic, Porcelain, Natural Stone, glass, vinyl, countertops and many other hard washable surfaces. It removes a multitude of stains without the need for alkalis, acids, bleaches and solvents.

- ✓ 100% organic and biodegradable.
- ✓ Cleans & deodorises.
- ✓ Suitable for most hard surfaces.
- ✓ Contains no acids, alkalis or bleach.
- ✓ Coverage up to 120m² Per Litre.

CODE	BARCODE	SIZE
EAS033	5019788000336	1 Litre



POWER CLEAN

A ready to use heavy duty cleaner.

Suitable for use on Ceramic, Porcelain and many other types of Natural Stone, including Polished Marble & Limestone.

- ✓ Contains a balanced combination of effective cleaning agents which are effective in dissolving ingrained dirt, wax layers, grease and many other problematic stains or coatings.
- ✓ Dissolves & removes ingrained dirt, grease and oil.
- ✓ Breaks down wax coatings and topical sealers.
- ✓ Quick cleaning acid free formula.
- ✓ Coverage up to 50m² per litre.

CODE	BARCODE	SIZE
POW034	5019788000343	1 litre



POWER STRIP

A specialist cleaner for removing heavy duty coatings such as acrylic and polyurethane.

- ✓ Emulsifies several layers of coating on each application.
- ✓ Suitable for use on most types of Porcelain and Natural Stone.
- ✓ Effective fast acting formula.
- ✓ Coverage up to 25m² per litre.

CODE	BARCODE	SIZE
PST035	5019788000350	1 Litre



CEMENT AWAY

Extra strong Cement Residue Remover.

- ✓ Effortlessly removes surface residues such as mortar, tile grout, cement, efflorescence, encrusted & engrained dirt, rust, calcium & lime scale deposits.
- ✓ For use on Ceramic, Quarry & Porcelain Tiles.
- ✓ Effective fast acting formula.
- ✓ Indoor & outdoor use.
- ✓ Coverage up to 40m² Per Litre.



CODE	BARCODE	SIZE
CEM032	5019788000329	1Litre

GROUT RESTORE

A special non-solvent cleaning agent designed to remove organic soiling, grease, fat and general dirt from grout.

- ✓ Binds contaminants together, making removal quick and easy by simply washing away with water.
- ✓ Leaves grout and tiles bright & hygienically clean.
- ✓ Fast & Effective.
- ✓ Coverage up to 100m² per litre.

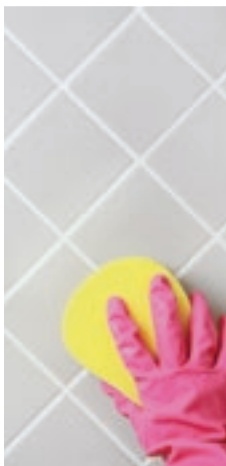

CODE	BARCODE	SIZE
GRE031	5019788000312	1Litre

MOULD AWAY

Removes mould and unsightly black spots commonly found on grout joints, silicone & other hard surfaces.

- ✓ Suitable for use around plastic & enamel baths & showers.
- ✓ Fast and effective formula.
- ✓ Coverage up to 100m² per litre.

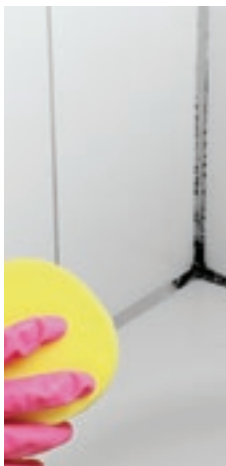

CODE	BARCODE	SIZE
MAW030	5019788000305	500ml

LIMESCALE REMOVER

Helps to remove limescale & calcium deposits from tiles, taps, bathtubs, shower heads, shower walls and other non-porous surfaces.

- ✓ Removes limescale, calcium deposits and watermarks.
- ✓ Fresh lemon fragrance.
- ✓ Ideal for use on tiles, taps, bathtubs & shower heads.
- ✓ Coverage up to 100m² per litre.

CODE	BARCODE	SIZE
LIM338	5019788003382	500ml

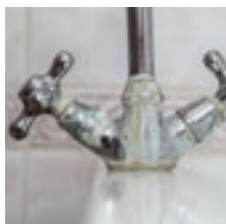

SINK & DRAIN UNBLOCKER

Liquid Power Sink & Drain Cleaner

- ✓ Suitable for kitchen and bathroom sinks and drains.
- ✓ Dissolves waste, solids, hair and sludge.
- ✓ Stops slow draining water.
- ✓ Regular use will keep your drains running smoothly.
- ✓ 500ml.

CODE	BARCODE	SIZE
DRA327	5019788003276	500ml





NEED HELP TO WORK OUT WHICH PRODUCT IS BEST FOR YOU? CALL OR GO ONLINE AND DOWNLOAD THE DATASHEET:

WWW.TILERITE.CO.UK

RAPID DRY AEROSOL

- ✓ Protects against oil and water-based stains.
- ✓ Non-yellowing, long lasting formula that will not change the appearance of the surface.
- ✓ Fast track formula can be applied instantly do damp wall & floor grout and tiles.
- ✓ Instant protection from stains, dries rapid & invisible.

SUITABLE FOR:

- ✓ Polished Porcelain
- ✓ Marble
- ✓ Quarry
- ✓ Terracotta
- ✓ Slate
- ✓ Porcelain
- ✓ Sandstone
- ✓ Granite
- ✓ Travertine
- ✓ Limestone
- ✓ Masonry



**DRY IN
30-60
MINS!**



CODE	BARCODE	SIZE
RDA042	5019788000428	600ml
RDA339	5019788003399	250ml

RAPID DRY LIQUID

- ✓ Protects all types of Natural Stone & Porcelain against oil and water-based staining.
- ✓ Non-yellowing, long lasting formula that will not change the appearance of the surface.
- ✓ Fast track formula can be applied instantly do damp wall & floor grout and tiles.
- ✓ Instant protection from stains, dries rapid & invisible.
- ✓ Coverage up to 40m2 Per Litre.

SUITABLE FOR:

- ✓ Polished Porcelain
- ✓ Marble
- ✓ Quarry
- ✓ Terracotta
- ✓ Slate
- ✓ Porcelain
- ✓ Sandstone
- ✓ Granite
- ✓ Travertine
- ✓ Limestone
- ✓ Masonry



**DRY IN
30-60
MINS!**



CODE	BARCODE	SIZE
RDS043	5019788000435	1 litre
RDS044	5019788000442	5 litre



FOR MORE INFORMATION OR TO ORDER
CALL US ON: 01543 500 893

CLEAN & SEAL RANGE

STAIN SHIELD

A Premium water-based Stone & Masonry impregnator that penetrates the surface of the stone to give superior protection against oil and water-based stains.

- ✓ Environmentally friendly & low odour formula.
- ✓ Dries fast and invisible.
- ✓ Interior & exterior use.
- ✓ Up to 15 years protection.
- ✓ Coverage up to 25m² per litre.

✗ Polished Porcelain	
✓ Marble	
✓ Quarry	
✓ Terracotta	
✓ Slate	
✗ Porcelain	
✓ Sandstone	
✓ Granite	
✓ Travertine	
✓ Limestone	
✓ Masonry	

DRY IN 20-30 MINS!

CODE	BARCODE	SIZE
SSH038	5019788000381	1 litre
SSH039	5019788000398	5 litre



STAIN SHIELD ENHANCE

A water based, Eco friendly colour enhancing stone sealer.

- ✓ Leaves the surface looking vibrant and shiny.
- ✓ Prevents water and dirt from penetrating into the surface making the slate easier to clean and maintain.
- ✓ Hard wearing UV resistant finish that will not yellow.
- ✓ Interior & exterior use.
- ✓ Coverage up to 15m² per litre.

✗ Polished Porcelain	
✓ Marble	
✓ Quarry	
✓ Terracotta	
✓ Slate	
✗ Porcelain	
✓ Sandstone	
✓ Granite	
✓ Travertine	
✓ Limestone	
✓ Masonry	

DRY IN 45-60 MINS!

CODE	BARCODE	SIZE
SSE040	5019788000404	1 litre
SSE041	5019788000411	5 litre



DID YOU KNOW?
REGULAR
MAINTENANCE OF
YOUR TILES USING
A PH-NEUTRAL
CLEANER WILL
ENHANCE THE
PERFORMANCE &
LONGEVITY OF YOUR
SEALER!

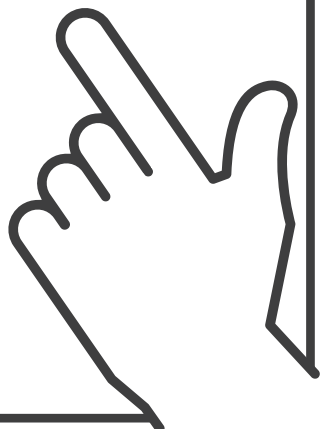

TOP TIP!
SOLVENT BASED
SEALERS ARE
RECOMMENDED FOR
FINELY HONED OR
POLISHED SURFACES
AS THE DENSITY
OF THE SOLVENT
TRANSPORTS THE
SEALER INTO THE
TILES!

SLATE SEAL

A Water based Eco-Friendly surface sealer to protect against oil and water-based stains.

- ✓ Leaves the surface looking vibrant and shiny.
- ✓ Prevents water and dirt from penetrating into the surface making the slate easier to clean and maintain.
- ✓ Hard wearing UV resistant finish that will not yellow.
- ✓ Interior & exterior use.
- ✓ Coverage up to 15m² per litre.



- ✗ Polished Porcelain
- ✗ Marble
- ✓ Quarry
- ✓ Terracotta
- ✓ Slate
- ✗ Porcelain
- ✓ Sandstone
- ✗ Granite
- ✗ Travertine
- ✗ Limestone
- ✓ Masonry



**DRY IN
45-60
MINS!**



CODE	BARCODE	SIZE
SLA036	5019788000367	1 litre
SLA037	5019788000374	5 litre



BOUTIQUE LUXURY TILE TRIMS

— RANGE — **coming soon...**

The boutique range offers unique on trend finishes that will complement modern tile designs and bathroom & kitchen fixtures & fittings.

For use surrounding a window frame, part tiled walls, external corners and surrounding a splash back. Designed to attractively finish tiling installations and protect unglazed tile edges prone to impact and damage.

Available in 7 finishes: Brushed Silver, Brushed Black, Embossed Silver, Brushed Copper, Bright Copper, Brushed Gold and Bright Gold

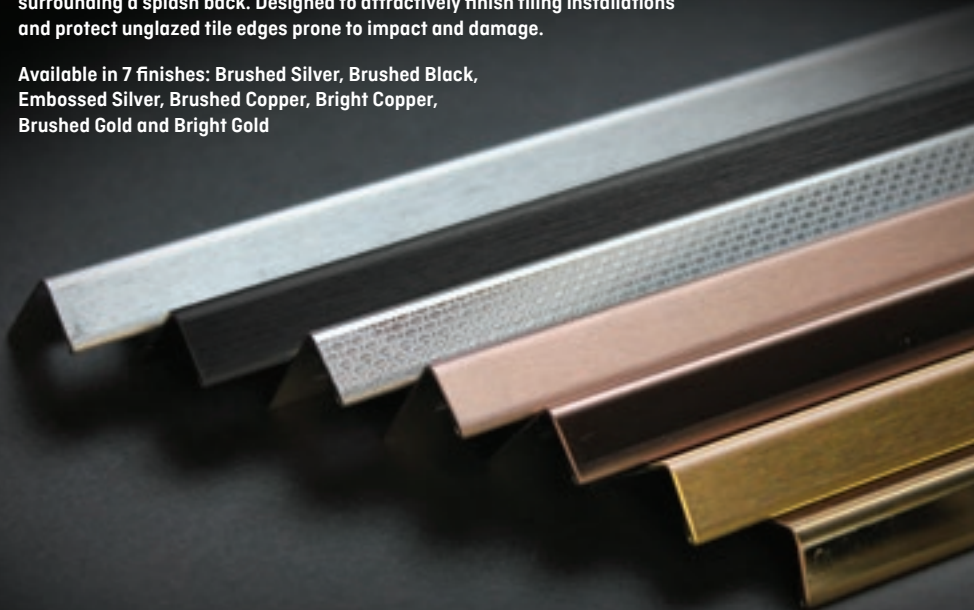



EVERYTHING BUT THE TILES!

ORDER BY TELEPHONE, EMAIL OR WEB

Always use our product codes when ordering by phone or email to ensure error free processing. If you want to order using our Online Portal, give us a call and we can set this up for you.



CALL:
01543
500 893



VISIT:
TILERITE.CO.UK



EMAIL:
sales@tilerite.co.uk

Tile Accessories Limited trading as Tile Rite, Unit 2, Phoenix Road, Hawks Green, Cannock, Staffordshire, WS11 7LR. Fax: 01543 500 894 Email: sales@tilerite.co.uk

TILE RITE RESERVE THE RIGHT TO MODIFY PRODUCTS WITHOUT PRIOR NOTICE. WHIST EVERY EFFORT IS TAKEN TO ENSURE THE ACCURACY OF INFORMATION CONTAINED WITHIN THIS BROCHURE, THE DETAILS ARE OFFERED IN GOOD FAITH AND TILE RITE ACCEPTS NO RESPONSIBILITY FOR MATTERS ARISING AS A RESULT OF ERRORS IN IT'S PRINT.