

CMS

TOOLS LTD

THE PROFESSIONAL ROOFER'S CHOICE CATALOGUE

QUALITY TOOLS & ACCESSORIES

AFFORDABLE PRICES

NEXT DAY DELIVERY

NEW EXTENDED RANGE



eternoivica

GRÜN



CONTENTS

Roofing Drains, Vents & Accessories	4
Specialist Roofing Items	12
Slating & Tiling Tools	16
Lead & Metal Working Tools	21
Fibreglass Tools	25
Heating Torches	27
Bitumen & Asphalt Melting	36
Hand Tools	41
Decorating & Brushware	50
General Equipment	54
Workwear & Toolbags	58
Façade Installation	62
Interior Fixture Cutting & Lifting Tools	68
Paving & Decking Supports	72



SPECIALIST TOOLS FOR PROFESSIONAL ROOFERS AND CONTRACTORS SINCE 1987

The right tools at the right price, chosen by experts.



NEXT DAY DELIVERY



LOW CARRIAGE PAID



SPECIALIST TECHNICAL SUPPORT



RIGHT PRODUCT, RIGHT PRICE



QUALITY, HANDPICKED RANGE



PROUDLY HSE COMPLIANT

ORDER LINE:
01924 895999

EMAIL: info@cmstools.co.uk

FAX: 01924 896999

Payment Home (UK) Strictly nett monthly account.

Payment Export in sterling on shipment of goods.

Minimum Order Value £15 nett.

Customers exceeding these terms are charged at our bank base - rate plus 10%.

Carriage: Delivery paid on orders in excess of £150 nett (except tile, boiler and direct to site deliveries, non mainland UK and Scottish Highlands).

Carriage will be charged as follows:

- **Normal - £15**
- **Next Day by 10.30am - £50**
- **Saturday - Not Available**
- **Direct to site - £30**
- **For tile deliveries, if less than 35 meters squared £50 carriage**
- **For boiler deliveries & medium/large overspill trays £50 carriage (excepting GRU19)**

NOTE: Certain products are marked in the catalogue as 'Special Order' they may require additional carriage costs depending upon the order value. Please contact us by phone or email to discuss.

Special Order - Special Orders POA and delivery within 5 days.

Delivery - Whilst we do our utmost to execute every order quickly, we cannot accept responsibility for any direct or indirect loss which may arise if the delivery is delayed as a result of strikes, lock-outs, non-delivery of materials by any other manufacturer, delays caused by carrier, non-payment of any outstanding accounts, or any other unforeseen circumstances.

Damage/Loss - We do not accept any responsibility for any damage or loss during transit unless the carriers or ourselves are notified in writing within 24 hours of receipt of invoice.

Exports - All prices are ex-works with packing cases chargeable at cost.

Title - Title to goods supplied only passes from the company on receipt of payment and all outstanding monies.

Value Added Tax - All prices are subject to VAT, added to invoices at the rate prevailing on the date of despatch.

Consequential Loss - CMS Tools Limited accept no consequential loss claims exceeding the nett value of the product supplied.

Returns & Faulty Goods - Goods will only be replaced FOC if they are faulty in manufacture - Only CMS Tools Ltd can determine whether goods are faulty or misused.

THE CMS TOOLS DIFFERENCE

- ✓ Individually selected products chosen by experts
- ✓ Stocked warehouse of 95% of products for fast processing and delivery
- ✓ Comprehensive range of specialist tools
- ✓ Nationwide network of stockists
- ✓ High quality range at the right price
- ✓ Knowledgeable team and personalised customer service.
- ✓ Next day delivery



ROOF DRAIN 'FIBREGLASS'

Available in five diameters 50-75-82-90-100mm. The liquid vertical exit drain includes a fibreglass mesh for bonding, particularly with water based liquid waterproofing materials. The polypropylene flange is designed with a knurled surface on both sides to improve adhesion of liquid waterproofing materials. Small steps on the upper part of the spigot allows upper infiltration water to be captured and drip away.



1

2

ADVANTAGES:

- Wide choice: Five diameters 50-75-82-90-100mm.
- Fibreglass mesh for bonding, works well with water based liquid waterproofing materials.
- Polypropylene flange with two sided knurled surface for strong adhesion of liquid waterproofing materials.
- Small steps on upper spigot allows upper infiltration water capture and drip away.

LIQUID STRAIGHT WITH FIBREGLASS MESH

Code	Type	for pipes Ø	A	B	C	D	Sale Price	
RD50FG	1	STRAIGHT WITH FIBREGLASS MESH	50	230	42.3	200	37	£29.17
RD75FG	1	STRAIGHT WITH FIBREGLASS MESH	75	230	70.3	200	66	£30.17
RD82FG	1	STRAIGHT WITH FIBREGLASS MESH	82	230	76.1	200	71.8	£31.17
RD90FG	1	STRAIGHT WITH FIBREGLASS MESH	90	230	84.8	200	80.5	£32.17
RD100FG	1	STRAIGHT WITH FIBREGLASS MESH	100	230	94.1	200	89.8	£33.17

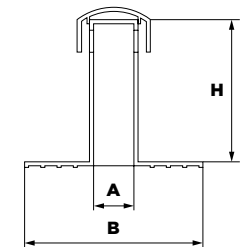
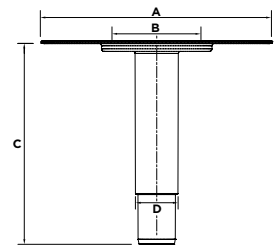

ROOF VENT

ROOF VENT

Code	Type	Ø external	A	B	H	Sale Price	
RF75FG	2	ROOF VENT	75	72	300	270	£37.36

FIBREGLASS PARAPET ROOF DRAIN

Manufactured from seamless GRP tube with chopped strand 900 weight matting bonded to create bonding surface with the roof membrane.

Please note the membrane must be dressed on to the internal diameter of the drain and consolidated into position to ensure 100% bond.



900g chopped strand matting

Code	A	B	Sale Price
RD82PARFG	500	82	£55.17
RD110PARFG	500	110	£59.67

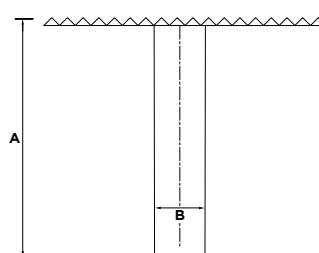

ROOF DRAIN 'TPE' AND 'EPDM'

eternoivica

TPE (Patented)[®]

- Unique design - circular row of holes for waterproofing membrane to be torched over and blended with the membrane below.
- 2 - 3 couples of anti-infiltration rings.
- Manufactured of special compound of thermoplastic rubber.
- Highly resistant to low temperatures (cold flexibility = -40°C).
- Compatible with all bituminous waterproofing membrane.

EPDM

The new TPE roof outlets with a smooth flange have been developed as the ideal solution for the adhesion of synthetic EPDM butyl rubber and similar waterproofing membranes.



ROOF DRAIN H 250mm								
Code		for pipes Ø	A	D1	D2	D3	H	Sale Price
RD63	1	63	320	51	60	49	250	£21.65
RD75	1	75	320	63	70	62	250	£21.65
RD82	1	82	320	69	75	68	250	£21.65
RD100	1	100	320	86	90	85	250	£21.65
RD110	1	110	380	95	101	94	250	£21.65
RD150	1	150	380	134	140	132	250	£21.65

ROOF DRAIN H 400mm EPDM								
Code		for pipes Ø	A	D1	D2	D3	H	Sale Price
RD63EPDM	2	63	320	51	60	49	400	£27.65
RD75EPDM	2	75	320	63	70	62	400	£27.65
RD82EPDM	2	82	320	69	75	68	400	£27.65
RD100EPDM	2	100	320	86	90	85	400	£27.65
RD110EPDM	2	110	380	95	101	94	400	£27.65
RD150EPDM	2	150	380	134	140	132	400	£34.83

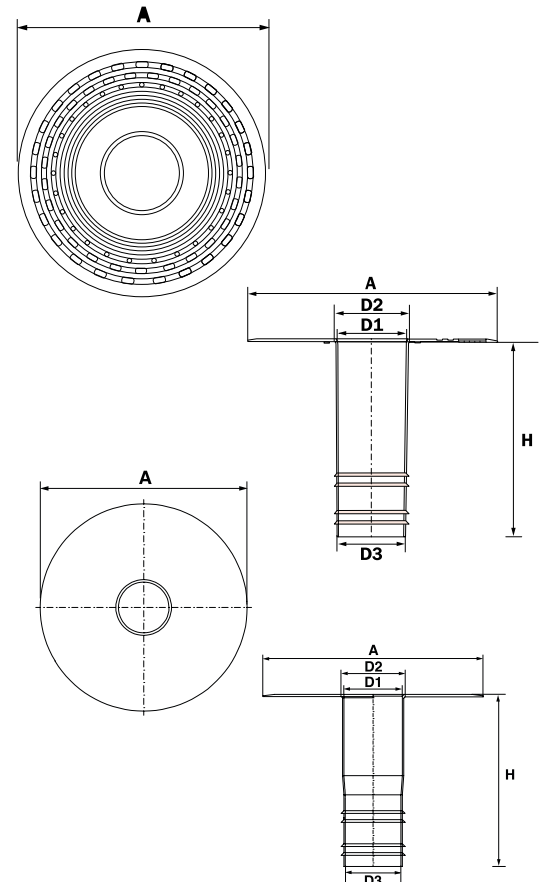

ROOF FITTINGS 'TPE' AND 'EPDM'

eternoivica

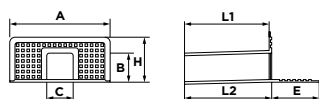
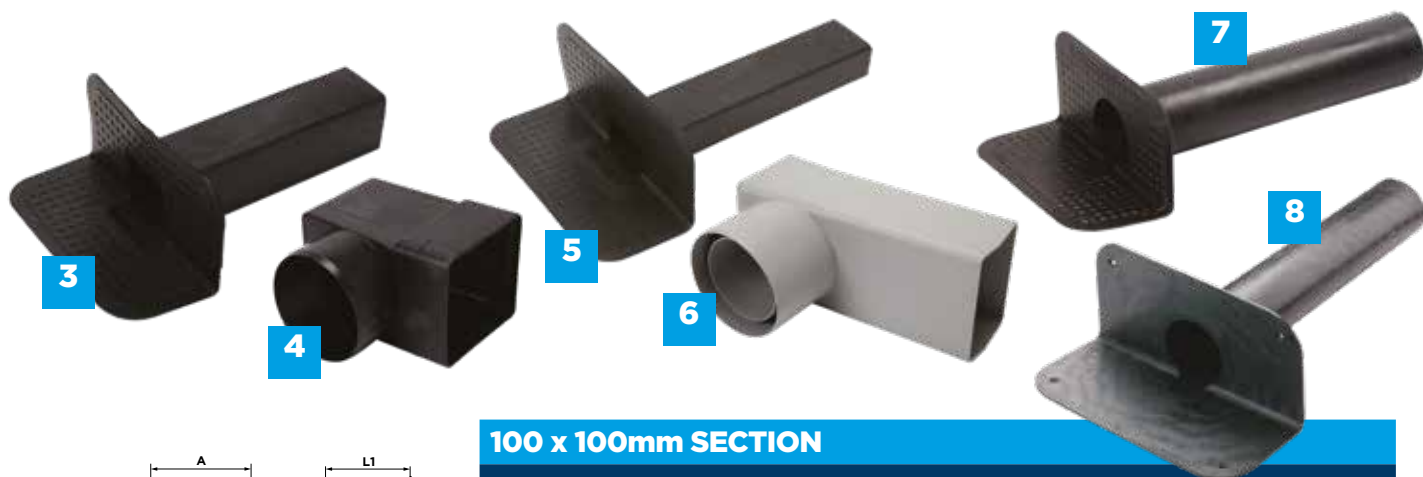

100 x 100mm SECTION

Code	Type	A	B	C	E	H	L1	L2	Sale Price
RD100PAR	3 TPE 90°	340	92	92	145	168	375	375	£31.67
RD100PAREPDM	3 EPDM 90°	340	92	92	145	168	375	375	£40.67

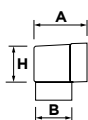

PIPE ADAPTOR 100 x 100mm SECTION

Code	Size	A	B	H	Sale Price
CON100	4 Ø 100	148	96	96	£6.32

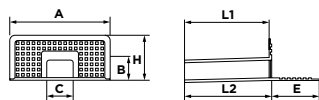

100 x 65mm SECTION

Code	Type	A	B	C	E	H	L1	L2	Sale Price
RD65PAR	5 TPE 90°	340	62	92	145	168	425	424	£31.67
RD65PAREPDM	5 EPDM 90°	340	62	92	145	168	425	424	£40.67

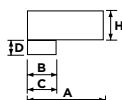

PIPE ADAPTOR 100 x 65mm SECTION

Code	Size	A	B	C	D	H	Sale Price
CON65	6 Ø 80-100	218	80	100	62	65	£6.58

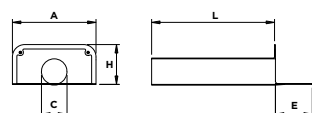

TPE ANGULAR DRAIN WITH ROUND SPIGOT

Code	for pipes Ø	A	C	E	H	L	Sale Price
RD63PARTPE	7 63	340	63	150	133	500	£54.50
RD75PARTPE	7 75	340	75	150	133	500	£54.50
RD80PARTPE	7 80	340	80	150	133	500	£54.50
RD90PARTPE	7 90	340	90	150	165	500	£54.50
RD110PARTPE	7 110	340	110	150	165	500	£54.50
RD125PARTPE	7 125	340	125	150	185	500	£54.50

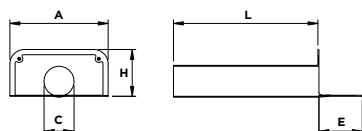

EPDM ANGULAR DRAIN WITH ROUND SPIGOT SMOOTH FLANGE

Code	for pipes Ø	A	C	E	H	L	Sale Price
RD63PAREPDM	8 63	340	63	150	133	500	£54.50
RD75PAREPDM	8 75	340	75	150	133	500	£54.50
RD80PAREPDM	8 80	340	80	150	133	500	£54.50
RD90PAREPDM	8 90	340	90	150	165	500	£54.50
RD110PAREPDM	8 110	340	110	150	165	500	£54.50
RD125PAREPDM	8 125	340	125	150	185	500	£54.50

ROOF DRAIN 'TPE' AND 'EPDM'

eternoivica



9

10



12

11



14



15



16



17

BASE FITTING FOR PIPES

Code	Type	D	D1	D2	H	Sale Price
PC40	9 TPE PIPE COLLAR	40	175	395	190	£17.25
PC40EPDM	10 EPDM PIPE COLLAR	40	175	395	190	£22.67

CORNERS

Code	Type	A	B	H	Sale Price
ICTPE	11 TPE INTERNAL CORNER MEDIUM	95	-	95	£1.80
ECTPE	12 TPE EXTERNAL CORNER MEDIUM	93	173	100	£1.99

ROOF VENTS

Code	Type	∅ external	A	B	H	H1	Sale Price
RF75	14 TPE ROOF VENT	75	72	300	270	-	£17.65
RF75EPDM	15 EPDM ROOF VENT	75	72	300	225	-	£19.98
RF75C	16 PROTECTION COLLAR	-	75	180	60	-	£2.15
RF105TPE	17 TPE MAXI ROOF VENT	105	100	300	270	-	£20.65

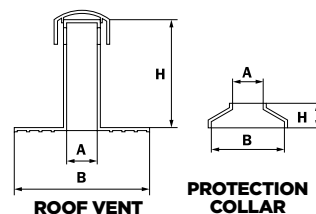
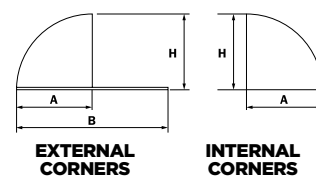
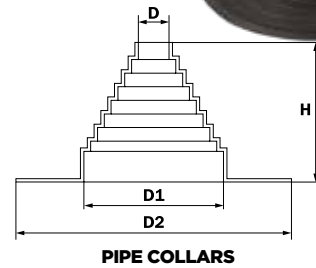

ROOF DRAIN 'PVC'/SINGLE PLY

Manufactured of PVC, it is highly resistant against low temperatures (cold flexibility = -40°C) as well as perfectly compatible with any sort of PVC membrane. The flange is totally smooth for a perfect bonding to the waterproofing sheet. According to the length of 250 or 400mm, the spigot is provided with two or three couples of anti-infiltration rings.

ADVANTAGES:

- Highly resistant to low temperatures (cold flexibility up to -40°C).
- Compatible with all PVC membranes.
- Smooth flange for bonding to waterproofing sheet.
- Spigot with two or three couples of anti-infiltration rings.
- 250mm length.

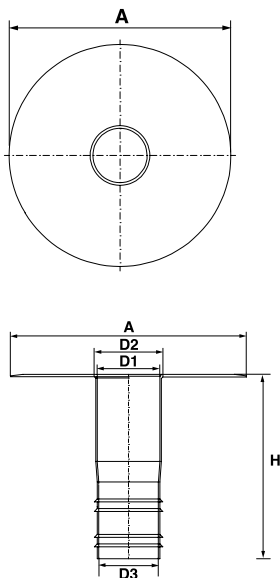

ROOF DRAIN H 250mm

Code		for pipes Ø	A	D1	D2	D3	H	Sale Price
RD63 PVC	1	63	320	51	60	49	250	£26.67
RD75 PVC	1	75	320	63	70	62	250	£26.67
RD82 PVC	1	82	320	69	75	68	250	£26.67
RD100 PVC	1	100	320	86	90	85	250	£26.67
RD110 PVC	1	110	380	95	101	94	250	£26.67
RD125 PVC	1	125	380	109	115	108	250	£26.67
RD150 PVC	1	150	380	134	140	132	250	£26.67
RD160 PVC	1	160	380	140	146	139	250	£26.67

ROOF DRAIN 'PVC'/SINGLE PLY

eternoivica



2



3



4



5



6

100 x 100mm SECTION

Code	Type	A	C	E	H	H1	L1	L2	Sale Price	
RD100PAR PVC	2	45°	340	92	145	168	92	375	375	£39.17

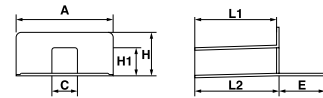

PIPE ADAPTOR 100 x 100mm SECTION

Code	Size	A	B	H	Sale Price	
CON100	3	∅ 100	148	96	96	£6.32

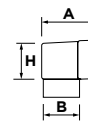

100 x 65mm SECTION

Code	Type	A	C	E	H	H1	L1	L2	Sale Price	
RD65PAR PVC	4	90°	340	92	145	168	62	425	425	£39.17

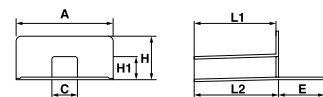

ANGULAR DRAIN WITH ROUND SPIGOT

Code	for pipes ∅	A	C	E	H	L	Sale Price
RD63PAR PVC	5	63	340	63	150	133	500.00
RD75PAR PVC	5	75	340	75	150	133	500.00
RD90PAR PVC	5	90	340	90	150	165	500.00
RD110PAR PVC	5	110	340	110	150	165	500.00
RD125PAR PVC	5	125	340	125	150	165	500.00

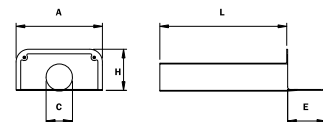

PIPE ADAPTOR 100 x 65mm SECTION

Code	Size	A	B	C	D	H	Sale Price	
CON65	6	∅ 80-100	218	80	100	62	65	£6.58

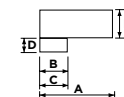

ROOF DRAIN 'PVC'/SINGLE PLY

eternoivica



USE WITH
JUBILEE
MULTIBAND
SEE PAGE 7

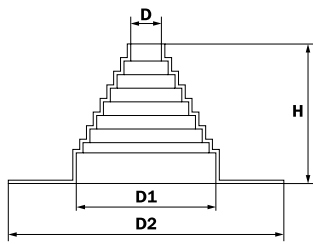

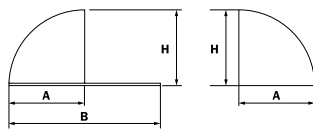

PIPE COLLARS

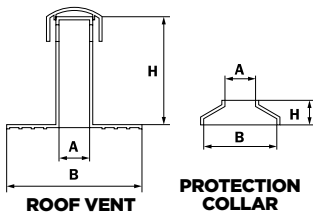

EXTERNAL CORNERS

INTERNAL CORNERS



ROOF VENT

PROTECTION COLLAR

BASE FITTING FOR PIPES

Code	Type	D	D1	D2	H	Sale Price
PC40PVC	7 PVC PIPE COLLAR	40	175	395	190	£26.65

CORNERS

Code	Type	A	B	H	Sale Price
ICPVC	8 INTERNAL CORNER MINI	70	-	70	£3.17
ECPVC	9 EXTERNAL CORNER MINI	67	128	70	£4.46

ROOF VENTS

Code	Type	∅ external	A	B	H	H1	Sale Price
RF75PVC	10 ROOF VENT	75	72	300	225	-	£26.67
RF105PVC	11 MAXI ROOF VENT	105	100	300	270	-	£30.67
RF75C	12 PROTECTION COLLAR	-	75	180	60	-	£2.15

ROOF DRAIN 'TPO'

eternoivica

Manufactured of universal polyolefine white, they are made to guarantee a perfect compatibility to any sort of TPO waterproofing membrane. The flange is totally smooth for a perfect bonding to the waterproofing membrane. The spigot is provided with two couples of anti-infiltration rings.

ADVANTAGES:

- Manufactured of 100% universal polyolefine white.
- Guaranteed compatibility with TPO waterproofing membranes.
- Smooth flange for easy bonding to the waterproofing membrane.
- Spigot made with two couples of anti-infiltration rings.

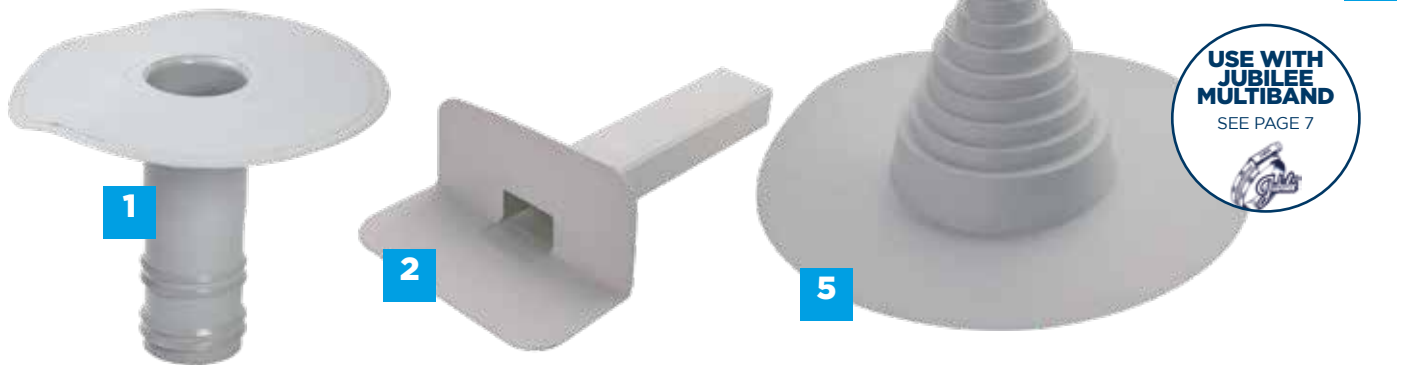

ROOF DRAIN H 250mm

Code		for pipes Ø	A	D1	D2	D3	H	Sale Price
RD63TPO	1	63	320	51	60	49	250	£26.67
RD75TPO	1	75	320	63	70	62	250	£26.67
RD100TPO	1	100	320	86	90	85	250	£26.67
RD110TPO	1	110	380	95	101	94	250	£26.67
RD150TPO	1	150	380	134	140	132	250	£26.67

ANGULAR DRAIN 100 x 65mm SECTION

Code	Type	A	C	E	H	H1	L1	L2	Sale Price	
RD65PAR TPO	2	90°	340	92	145	168	62	425	425	£39.17

ROOF VENT H 225 - Ø 75mm

Code	Type	Ø external	A	B	H	H1	Sale Price	
RF75TPO	3	ROOF VENT	75	72	300	225	-	£26.67
RF75C	4	PROTECTION COLLAR	-	75	180	60	-	£2.15

BASE FITTING FOR PIPES

Code	Type	D	D1	D2	H	Sale Price	
PC40TPO	5	TPO PIPE COLLAR	40	175	395	190	£26.65

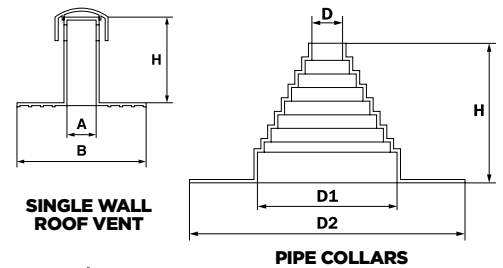
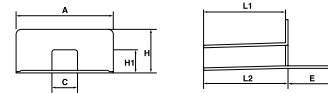
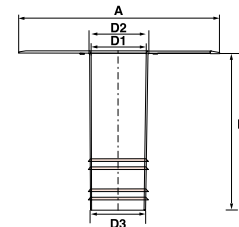
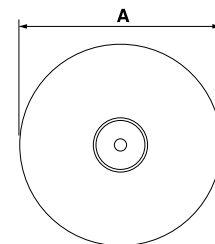

SINGLE WALL ROOF VENT

PIPE COLLARS

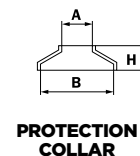

PROTECTION COLLAR

ROOF FITTINGS UNIVERSAL

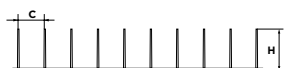
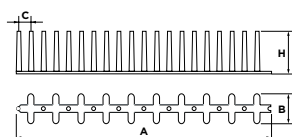
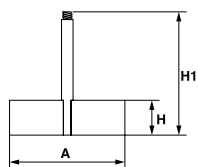
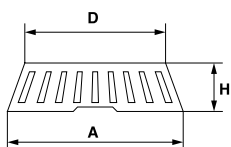
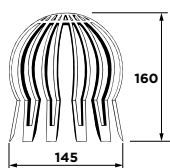
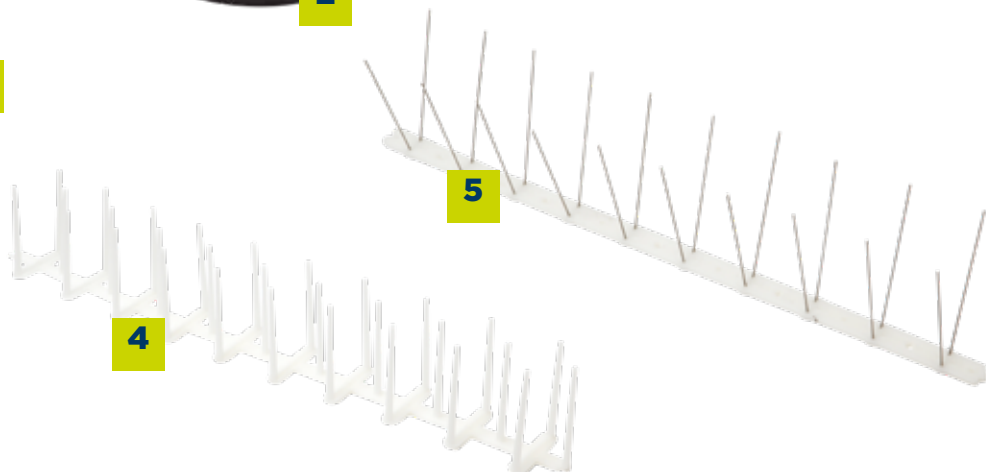

FLEXIBLE PP LEAF-GUARD

Code	Size	Type	Sale Price
LG01	1 60-140	STANDARD PP	£3.01

GRAVEL-GUARD

Code	Type	A	D	H	Sale Price
GG01	2 GRAVEL GUARD	195	170	50	£5.52

UNIVERSAL ADAPTOR

Code	Type	A	H	H1	Sale Price
GG015	3 UNIVERSAL ADAPTOR	130	40	150	£2.12

PLASTIC BIRD GUARD

Code	Colour	A	B	C	H	Sale Price
BG1	4 WHITE	500	55	25	80	£4.34

STAINLESS STEEL BIRD SPIKE

Code	Type	A	B	C	H	Sale Price
BG01SS	5 STANDARD	500	20	50	110	£6.60

MULTI-FUEL BIRDCAP AND RAINCAP

Multi-fuel birdcap prevents birds, vermin and leaves entering the chimney. This product provides good ventilation and gives protection against wind and rain.

Key Features

Available with bolt or strap fixings
Fits flue sizes 125-250mm internal diameter



Code	Description	Sale Price
CO1	MULTI-FUEL BIRDCAP AND RAINCAP BOX QUANTITY 6	£57.50 Each

SPRUNG BIRD GUARD

Sits in the top of the chimney and, once placed, the arms flare out, gripping the inside wall of the pot. This stops large debris and birds getting in. Simple to fit, a long lasting solution.

Key Features

Fits flue sizes 155-225mm internal diameter - spring fit



Code	Description	Sale Price
CO2	SPRUNG BIRD GUARD BOX QUANTITY 10	£38.20 Each

SPIN COWL

Spin Cowl is a revolving cowl, designed to eradicate downdraught whilst the rotating action assists ventilation.

Key Features

Fully assembled - ready to fit
Fits pots from 125-250mm diameter
Tested to BS715:1993 and against BSEN 1856
Suitable for flue temperatures up to 200°C
Solves problems of downdraught whilst the rotating action increases ventilation



Code	Description	Sale Price
CO3	SPIN COWL	£216.65

FIXED COWL

A static anti-downdraught cowl. Tested to BS715:1993 and against BSEN 1856 pt2 and hence suitable for all fuel types including gas.

Key Features

Fully assembled - ready to fit - with birdguard
Fits flue sizes 125-250mm internal diameter
Suitable for flue temperatures up to 200°C
Manufactured from 1.6mm test house approved aluminium
Available with stainless steel bolt or strap fixings



Code	Description	Sale Price
CO4	FIXED COWL BOX QUANTITY 8	£83.32 Each



Code	Description	Sale Price
STRAP	COPPER SLATE STRAP 150mm x 10mm (PER 10)	£6.15



Code	Description	Sale Price
HIP4	300mm x 150mm x 4mm HIP IRON BOX QUANTITY 50	£3.15 Each
HIPBABY	BABY HIP IRON 200mm x 100mm x 3mm BOX QUANTITY 100	£3.15 Each

NEW

Code	Description	Sale Price
M104	RAIN MATE SEALANT BOX QUANTITY 25	£6.75 Each

Code	Description	Sale Price
MESH30	INSECT MESH (30m x 75mm)	£27.08

NEW



CHIMNEY GUARD

Chimney guard/leaf guard to prevent debris from entering the chimney pot.

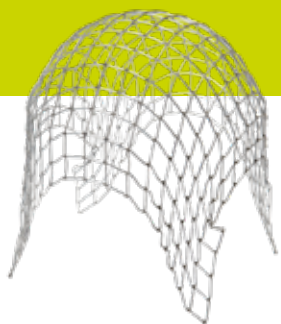

Code	Description	Sale Price
CH063	2.5" CHIMNEY GUARD	£3.00
CH075	3" CHIMNEY GUARD	£3.22
CH100	4" CHIMNEY GUARD	£3.84
CH150	6" CHIMNEY GUARD	£6.71
CH200	8" CHIMNEY GUARD	£11.06
CH230	9" CHIMNEY GUARD	£13.98



Code	Description	Sale Price
GG01	50-170mm GRAVEL GUARD BOX QUANTITY 50	£5.52 Each
GG015	SPIGOT FOR GRAVEL GUARD 50mm x 170mm BOX QUANTITY 50	£2.12 Each



Code	Description	Sale Price
LG01	50-150mm LEAF GUARD	£3.01



Code	Description	Sale Price
BGI	BIRD GUARD 500mm PLASTIC	£4.34
BG01SS	BIRD GUARD 500mm STAINLESS STEEL	£6.60

ROOFER RIDGE BUCKET

Designed for roofers, this hard-wearing and durable ridge bucket comes with a host of convenient features. The rigid 'V' shaped base to the bucket allows the bucket to sit on the roof ridge without risk of spillage. The heavy duty plastic and metal handle ensures that fully laden buckets are comfortably and safely transported around the roof without accident. A strong hook moulded into the rim of the bucket allows the user to hook the ridge bucket over batten and ladder rungs.



Code	Description	Sale Price
1520	ROOFER RIDGE BUCKET	£13.71



Code	Description	Sale Price
HH01	HALL HOOKS (PKT 10)	£19.99
HH01MG	HALL HOOKS - MARINE GRADE (PKT 10)	£22.99



Code	Description	Sale Price
GG02	GUTTER GUARD - BROWN - 6m ROLL 18cm WIDE BOX QUANTITY 12	£21.38 Each

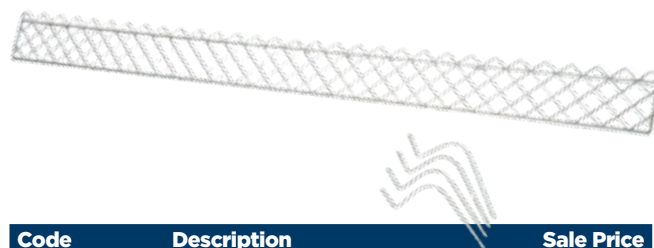

Code	Description	Sale Price
SN2	150mm x 2m SNOWGUARD	£41.58
SNBRACKET	BRACKET TO SUIT SNOWGUARD	£5.50



Code	Description	Sale Price
V1	ALLOY VERGE CLIP 18mm x 65mm x 170mm BOX QUANTITY 100	£1.20 Each



Code	Description	Sale Price
GGB	GUTTER BRUSH 100mm x 4m BOX QUANTITY 10	£19.99 Each



Code	Description	Sale Price
EDM133355	EDMA DECLIMETER	£7.17



Code	Description	Sale Price
417A	ANGLE FINDER BOX QUANTITY 6	£15.17 Each



Code	Description	Sale Price
LADCLAMP	LADDER CLAMP	£36.15



Code	Description	Sale Price
800	LADDER ROOFHOOK	£52.07



Code	Description	Sale Price
SAFECLAMP	LOCKABLE LADDER CLAMP	£79.17



USE WITH
**JUBILEE
MULTIBAND**
SEE PAGE 7

Code	Description	Sale Price
5004	4" 500 GAUGE LAYFLAT TUBING FOR TEMPORARY DOWNPIPE (4 KILO ROLL)	£36.57

EDMA 0310 MAT SLATE & PUNCH CUTTER

The Edma 0310 Mat Slate & Punch Cutter is a high quality tool for use in cutting and punching roof slate tiles. It features spring loaded handles for power, precision cutting and comes with ergonomic soft grip handles.

Key Features

Lightweight and compact
Ideal for cutting punching roof slate tiles
Single hand compound action
Soft grip handles
Replaceable blade and punch

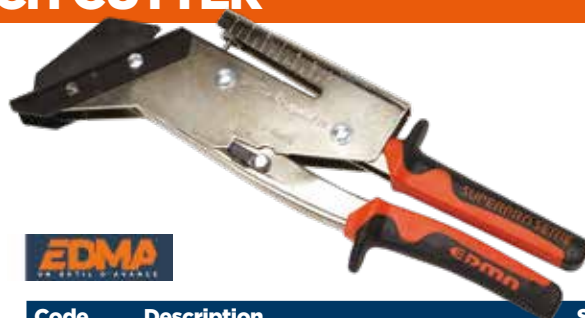
Code	Description	Sale Price
0310	EDMA SLATE CUTTER C/W PUNCH	£62.72 Each
0324	EDMA SLATE CUTTER C/W PUNCH LARGE BLADE	£80.84 Each

BOX QUANTITY 5

EDMA 0320 MAT COUP SLATE CUTTER

The Edma 0320 Mat Coup Slate Cutter is a high quality tool for use in cutting roof slate tiles. It features spring loaded handles for power and precision cutting, will cut slate up to 7mm thick and comes with ergonomic soft grip handles.

Key Features

Lightweight and compact
Ideal for cutting roof slate tiles
Single hand compound action
Cuts up to 7mm thick slates
Soft grip handles



Code	Description	Sale Price
0320	EDMA SLATE CUTTER NO PUNCH	£47.50 Each
0325	EDMA SLATE CUTTER NO PUNCH LARGE BLADE	£65.17 Each

BOX QUANTITY 5

EDMA SLATE KIT

Comprises of a large sturdy plastic tool box with a carry handle and range of tools included.

Includes

1x EDMA slate cutter with punch
1x Lead snips
1x Chalk line
1x Chalk flask
1x Utility snips
1x Tool box



Code	Description	Sale Price
3310	EDMA SLATE KIT	£123.33

EDMA PROFESSIONAL ROOFER SET - FLYER & CUTTER

The EDMA 0365 Maxi-Pro Roofer Pack offers a high quality package ideal for professional builders and roofers. The slate cutter features an integrated hold punch and will shape slate, eternit and fibre without any dust or crumbling.

Key Features

- Lightweight and compact
- Ideal for cutting punching roof slate tiles and cutting zinc/PVC
- Single hand compound action
- Soft grip handles
- Long life
- Cuts without any dust or crumbling
- Tinsnip has non-slip serrated blades



Code	Description	Sale Price
0365	EDMA PROFESSIONAL ROOFER SET - FLYER AND CUTTER 0310 + 0106	£89.25



Code	Description	Sale Price
2310	EDMA MASTERCUT BOX QUANTITY 5	£90.00 Each



Code	Description	Sale Price
0318	EDMA HAMMER TACKER (10/12/14mm STAPLES) BOX QUANTITY 5	£47.95 Each



Code	Description	Sale Price
0311	EDMA TOP BLADE	£11.03



Code	Description	Sale Price
0312	EDMA DRILLING PUNCH	£11.04



Code	Description	Sale Price
0313	EDMA CUTTING DIE	£14.80



Code	Description	Sale Price
0315	EDMA REPAIR KIT	£7.97



Code	Description	Sale Price
1008	SLATERS AXE RIGHT HAND	£25.32
1009	SLATERS AXE LEFT HAND	£25.32



Code	Description	Sale Price
1002	BREAK IRON 1 POINT	£16.26
1001	BENCH IRON 2 POINT	£19.17
1002S	SLATERS ANVIL - STRAIGHT BLADE	£19.17
1002C	SLATERS ANVIL - CURVED BLADE	£19.17



Code	Description	Sale Price
0899	VARIOCUT GUILLOTINE TO CUT FIBRE CEMENT SIDING	£307.92



Code	Description	Sale Price
RIG	HIP RUNNERS	£71.00 Per Pair



Code	Description	Sale Price
1017	SLATE CHOPPER 24" CUTTING BLADE	£171.50



Code	Description	Sale Price
304	SOFFIT CUTTER	£25.00



Code	Description	Sale Price
1018	TURBO SHEAR	£305.97

EDMA SLATE CUTTERS



EDMA Roll Mat - 600mm Slate Cutter

Key Features

- 2 different working positions: straight position for ground work and tilted position for roof work.
- Easily attached to roof battens thanks to its notches.
- Large cutting platform graduated every 10mm.
- Square gauges for regular straight and angular cuts.
- Cutting trolley guiding on bearings and rubber end stops.
- Carrying strap and dust collector included.
- For natural and synthetic slates up to 6mm thickness.
- Trolley locking system.



Code	Description	Sale Price
0355	EDMA ROLL MAT - 600mm SLATE CUTTER	£719.46

EDMA Small Slate Guillotine Machine Key

Key Features

- Mounting hook for fixing to a lathe or bench.
- Ideal for cutting up to 7mm thick slate tiles.
- Lightweight and compact.
- 210mm capacity.
- Highly durable design.
- Heavy-duty design.



Code	Description	Sale Price
0330	EDMA SMALL SLATE GUILLOTINE MACHINE	£79.17

**BEST
SELLER**



Code	Description	Sale Price
807A	DIMAR DOUBLE TIP SCRIBE BOX QUANTITY 10	£14.74 Each
807	BRITISH DOUBLE TIP SCRIBE BOX QUANTITY 10	£14.74 Each
808	SINGLE TIP SCRIBE	£4.34 Each



Code	Description	Sale Price
902	SLATE RIPPER ECONOMY	£11.99



Code	Description	Sale Price
0316	SLATE RIPPER STAINLESS STEEL	£41.70

NEW



Code	Description	Sale Price
108	SLATERS HAMMER STEEL SHAFT	£26.19
107	SLATERS HAMMER WOODEN SHAFT	£33.99

EDMA
ESTABLISHED 1947



NEW

Code	Description	Sale Price
807M	MARSHALLTOWN 2-IN-1 SCRIBE	£11.25
EDM251455	SCRIBE TIP	£8.28



Code	Description	Sale Price
903	SLATE RIPPER FORGED PRO	£26.19



**ROOFERS
FAVOURITE**

Code	Description	Sale Price
1381	UNIVERSAL SLATERS HAMMER	£81.25



Estwing

Code	Description	Sale Price
117	ESTWING SLATERS PICK	£72.99



DOUBLE SLATE PUNCHING MACHINE

Heavy duty double hole slate punch machine for slate up to 12mm thick.

Key Features

Fully adjustable
Can be fixed to a work bench

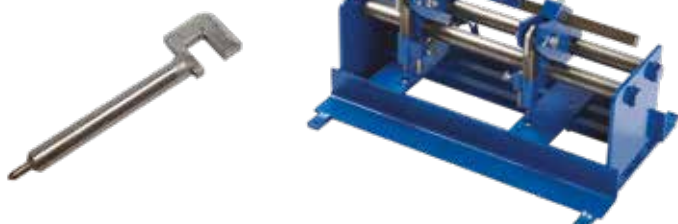

Code	Description	Sale Price
1015	DOUBLE SLATE PUNCHING MACHINE	£750.00
1016	1015 SPARE MACHINE PUNCH	£48.00

MULTI BORER

For cutting holes in slate with just one turn of the handle
British made heavy duty tool.

Key Feature

Right or Left hand operation



Code	Description	Sale Price
1030	MULTI BORER 7mm PUNCH HOLE	£295.00
1030A	MULTI BORER SPARE PUNCH	£24.99



Code	Description	Sale Price
BAT1	BATTEN GAUGE	£18.25



NEW

Code	Description	Sale Price
EDM087555	EDMA TELESCOPIC BATTEN LIFTER	£76.09
0332	EDMA BATTEN LIFTER	£40.00



Code	Description	Sale Price
1104	LONG HANDLED TILE NIBBLER BOX QUANTITY 5	£29.58 Each



Code	Description	Sale Price
1101	TILE CROPPER HEAVY DUTY	£99.99
1102	CROPPER SPARE BLADES	£24.99

OXY TURBO GAS WELDING KIT

The Oxy Turbo 90 Kit is the smallest autogenous welding system available.

It is compact, powerful and allows the end-user to make professional welding being particularly suitable for small roofing works.

The product safety is guaranteed by four flashback arrestors with double protection: one on the pressure reducer, one on the gas tap and two integrated in the handgrip.

Supplied with disposable gas & oxygen bottles (spares available separately) and accessories in an elegant space-saving metal trolley.

Compact and highly effective, the weight of the kit is minimal at 5kgs. A practical handle and two blocking devices for bottles make it possible to carry the set everywhere.

Includes

- Valved welding torch with standard nozzle
- Hoses with check valves
- Oxygen and turbo gas regulators
- Stella nozzle set
- Carry frame
- 2 brazing rods
- Goggles
- Spark lighter
- Instructions



Code	Description	Sale Price
751	OXY TURBO OXYGEN REFILL	£27.19 Each
752	OXY TURBO GAS REFILL	£14.08 Each

BOX QUANTITY 12



Code	Description	Sale Price
749A	OXY TURBO HANDSET & HOSE ASSEMBLY	£132.82



Code	Description	Sale Price
754	OXY TURBO SPARE NECK TUBE	£21.65



Code	Description	Sale Price
748	STELLA NOZZLE SET	£30.45



Code	Description	Sale Price
724	LEAD STRIKING PLATE	£64.00



Code	Description	Sale Price
MOT14	ROSE SMALL 60mm	£7.75
MOT12	ROSE MEDIUM 90mm	£16.17
MOT13	ROSE LARGE 100mm	£21.07
MOT17	RIVET HEAD 30mm	£4.42
MOT18	DOME HEAD/DOT 15mm	£5.10



Code	Description	Sale Price
HC01	HALL CLIPS STANDARD PER 50 BOX QUANTITY 10	£11.25 Each
HC02	HALL CLIPS LARGE PER 25 BOX QUANTITY 5	£11.25 Each



Code	Description	Sale Price
PAT10	1000ml LEAD PATINATION OIL	£13.25 Each
PAT100	500ml LEAD PATINATION OIL BOX QUANTITY 2	£9.50 Each



Code	Description	Sale Price
715	CHASE WEDGE SMALL 50mm	£15.83
716	CHASE WEDGE MEDIUM 58mm	£15.83
717	CHASE WEDGE LARGE 76mm	£23.17



Code	Description	Sale Price
708	BOSSING STICK WOOD	£21.42



Code	Description	Sale Price
710	BENDING STICK WOOD	£21.42



Code	Description	Sale Price
719	SETTING STICK WOOD	£20.17



Code	Description	Sale Price
701	SMALL WOOD LEAD DRESSER 48mm	£16.36
703	MEDIUM WOOD LEAD DRESSER 55mm	£22.92
705	LARGE WOOD LEAD DRESSER 60mm	£28.50



Code	Description	Sale Price
M102	FLASH MATE SEALANT	£4.99





Code	Description	Sale Price
709	BOSSING STICK PLASTIC	£22.93



Code	Description	Sale Price
720	SETTING STICK PLASTIC	£23.03



Code	Description	Sale Price
797	PLASTIC LEAD DRESSER KIT	£79.17

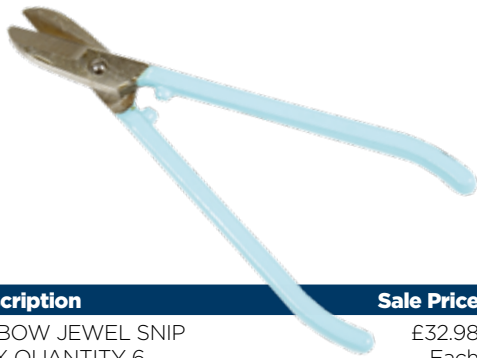

Code	Description	Sale Price
501	GILBOW JEWEL SNIP BOX QUANTITY 6	£32.98 Each



Code	Description	Sale Price
507	LEFT H. GILBOW G67 TINSNIP	£62.40 Each

Code	Description	Sale Price
508	RIGHT H. GILBOW G69 TINSNIP BOX QUANTITY 6	£62.40 Each



Code	Description	Sale Price
706	SMALL PLASTIC LEAD DRESSER 52mm	£22.17

Code	Description	Sale Price
707	MEDIUM PLASTIC LEAD DRESSER 55mm	£32.53

Code	Description	Sale Price
700	LARGE PLASTIC LEAD DRESSER 60mm	£44.67



Code	Description	Sale Price
711	BENDING STICK PLASTIC	£22.93



Code	Description	Sale Price
721	PLASTIC CHASE WEDGE	£18.90



Code	Description	Sale Price
723	LEAD BENDER TOOL	£10.75

Code	Description	Sale Price
724	LEAD STRIKING PLATE	£64.00



Code	Description	Sale Price
504	8" GILBOW TINSNIP	£27.42 Each

Code	Description	Sale Price
505	10" GILBOW TINSNIP	£35.55 Each

Code	Description	Sale Price
506	12" GILBOW TINSNIP BOX QUANTITY 6	£38.50 Each



Code	Description	Sale Price
510	DUCKBILL TINSNIPS	£15.42

Code	Description	Sale Price
0105	S&J EXTRA CUT SNIPS	£16.50



Code	Description	Sale Price
795	LEAD WORK SCRAPER	£4.84



Code	Description	Sale Price
817	MASTER ROOFER LEAD KNIFE	£48.50 Each
817S	HOOKED LINO KNIFE (NOT RECOMMENDED FOR LEAD)	£20.00 Each



Code	Description	Sale Price
718	MASTER ROOFER 100mm SEAMING PLIER STRAIGHT	£125.00 Each
718C	MASTER ROOFER 100mm SEAMING PLIER CRANKED	£125.00 Each

BOX QUANTITY 3



Code	Description	Sale Price
EDM034455	EDMA CLINCHING PLIERS CRANKED 45°	£83.14



Code	Description	Sale Price
EDM039355	EDMA CLINCHING PLIERS STRAIGHT	£65.64

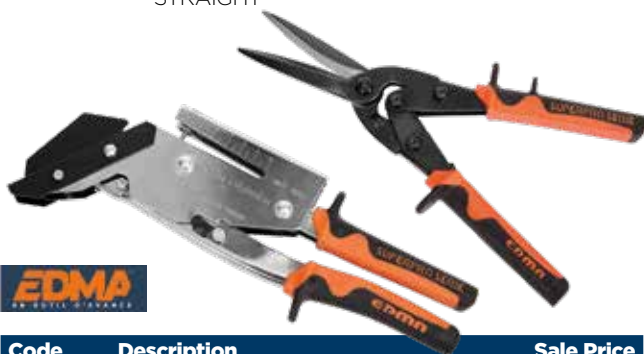

Code	Description	Sale Price
0365	EDMA PROFESSIONAL ROOFER SET - FLYER AND CUTTER 0310+0106	£89.25 Each



Code	Description	Sale Price
722	RUBBER Mallet BOX QUANTITY 6	£5.47 Each



Code	Description	Sale Price
735	PLASTIC BOSSING Mallet 6"	£36.83



Code	Description	Sale Price
502	10" TINSNIPS	£12.67
503	10" ECLIPSE TINSNIPS	£18.92
503A	12" ECLIPSE TINSNIPS	£19.98



Code	Description	Sale Price
0107	EDMA FLYER METAL SHEAR BLADE 42mm BOX QUANTITY 5	£27.92 Each



Code	Description	Sale Price
0106	EDMA FLYER METAL SHEAR BLADE 75mm BOX QUANTITY 5	£34.58 Each



Code	Description	Sale Price
0745	EDMA PLURICOUPE BOX QUANTITY 5	£15.15 Each



Code	Description	Sale Price
0310	EDMA SLATE CUTTER WITH PUNCH BOX QUANTITY 5	£62.72 Each



Code	Description	Sale Price
2050	SHORT HANDLE 4" ROLLER FRAME BAG QUANTITY OF 6	£3.13 Each
2052	4" REFILL BOX QUANTITY 10	£0.72 Each
2078	4" REFILL (VELOUR) BOX QUANTITY 10	£1.15 Each



Code	Description	Sale Price
2051	LONG HANDLE 4" ROLLER FRAME BAG QUANTITY OF 6	£4.19 Each
2052	4" REFILL BOX QUANTITY 10	£0.72 Each
2078	4" REFILL (VELOUR) BOX QUANTITY 10	£1.15 Each



PADDLE ROLLER

Code	Description	Sale Price
2060	4" CONSOLIDATED ROLLER	£5.24 Each
2061	6" CONSOLIDATED ROLLER	£6.03 Each
20619	9" CONSOLIDATED ROLLER	£7.32 Each

BOX QUANTITY 12



BUBBLE ROLLER

Code	Description	Sale Price
2057	4" 'SPLASH FREE' CONSOLIDATED ROLLER	£5.24 Each
2058	6" 'SPLASH FREE' CONSOLIDATED ROLLER	£6.03 Each
2059	9" 'SPLASH FREE' CONSOLIDATED ROLLER	£6.97 Each

BOX QUANTITY 12



Code	Description	Sale Price
2062	3" GRP APPLICATION ROLLER C/W FRAME	£2.03 Each
2064	6" GRP APPLICATION ROLLER C/W FRAME	£3.12 Each
2063	9" GRP APPLICATION ROLLER C/W FRAME	£3.78 Each

BAG QUANTITY 10



Code	Description	Sale Price
2065	10" STRONG ARM FRAME FOR GRP	£2.67 Each
2066	10" GRP SLEEVE STRONG ARM	£3.42 Each
2080	10" GRP SLEEVE (VELOUR) FOR STRONG ARM	£3.42 Each

BAG QUANTITY 10



Code	Description	Sale Price
1200	SURETOUCH GLOVES 100 PER BOX	£13.75



Code	Description	Sale Price
2002L	2" LAMINATING BRUSH	£0.98 Each
2003L	3" LAMINATING BRUSH	£1.37 Each
2004L	4" LAMINATING BRUSH	£1.92 Each

BOX QUANTITY 12



Code	Description	Sale Price
2071	3 PIECE WOODEN MIXER	£3.10



Code	Description	Sale Price
2069	POWER WHISK	£3.74



Code	Description	Sale Price
2035	12" PAINT SKUTTLE	£6.68



Code	Description	Sale Price
2036	GRP MINI SKUTTLE	£2.78



Code	Description	Sale Price
2068	MASKING TAPE	£2.94
2067	DUCT TAPE	£3.80



Code	Description	Sale Price
2620	FFP3 RESPIRATOR	£2.50 Each

Code	Description	Sale Price
2038KIT	GRP STARTER KIT	£49.99

Kit includes:

- Short handle 4" roller frame
- x10 roller refills
- x6 wooden laminating brush
- 6" consolidated roller
- 12" paint skuttle
- Suretouch latex gloves 100 per box
- x3 9" GRP application roller C/W frame



TURBO SELF IGNITION TORCH KIT

High quality self-igniting torch, igniter located on the head of the torch, fully adjustable. Includes 5m hose and 0-4 bar regulator.

Please note these are factory assembled and parts are non-interchangeable.

Code	Description	Sale Price
FIA01COMP	TURBO SELF IGNITION 180/50 TORCH WITH ACCESSORIES	£76.22
FIA02COMP	TURBO SELF IGNITION 380/50 TORCH WITH ACCESSORIES	£82.03
FIA03COMP	TURBO SELF IGNITION 600/50 TORCH WITH ACCESSORIES	£85.21
FIA01	TURBO SELF IGNITION 180/50 TORCH ONLY	£52.88
FIA02	TURBO SELF IGNITION 380/50 TORCH ONLY	£54.81
FIA03	TURBO SELF IGNITION 600/50 TORCH ONLY	£58.54

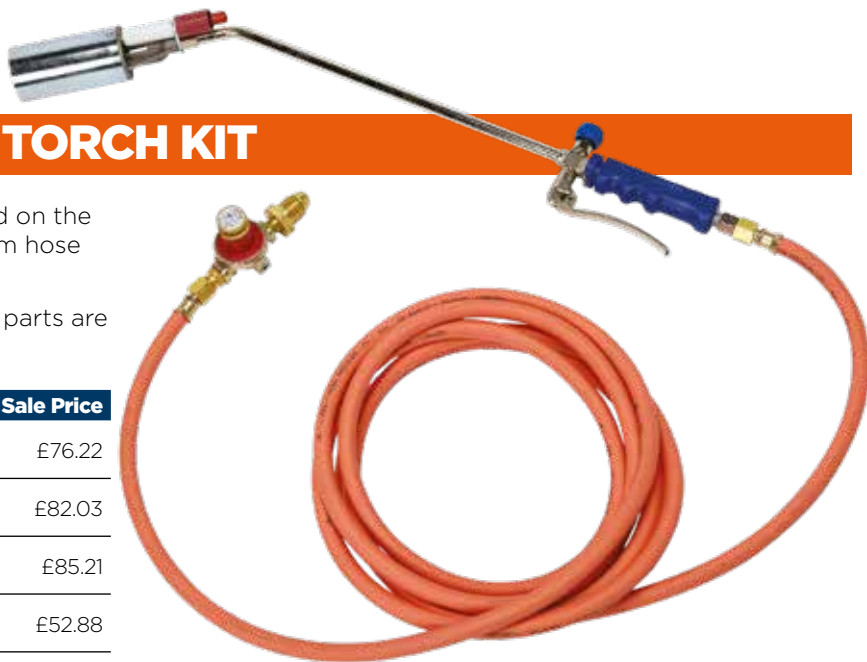

IDEAL TORCH KIT



Code	Description	Sale Price
1703-5	5m LENGTH ARMoured HOSE INC CRIMPS AND FITTINGS	£37.85



**3 SIZES
NOW
AVAILABLE**



Code	Description	Sale Price
1701A-5	5m LENGTH 8mm ORANGE HOSE INC CRIMPS AND FITTINGS	£23.09
1701A-10	10m LENGTH 8mm ORANGE HOSE INC CRIMPS AND FITTINGS	£36.75
1701A-15	15m LENGTH 8mm ORANGE HOSE INC CRIMPS AND FITTINGS	£49.99
1701A-20	20m LENGTH 8mm ORANGE HOSE INC CRIMPS AND FITTINGS	£62.50
1701A-30	30m LENGTH 8mm ORANGE HOSE INC CRIMPS AND FITTINGS	£87.50
1701A-50	50M LENGTH 8MM ORANGE HOSE (NOT CRIMPED)	£136.50

Code	Description	Sale Price
IDEAL 50S	IDEAL 150/50 DETAILED GAS TORCH AND HEAD AND NECK	£78.33
IDEAL 50	IDEAL 350/50 MEDIUM GAS TORCH AND HEAD AND NECK	£83.00
IDEAL 76	IDEAL 600/76 LARGE GAS TORCH AND HEAD AND NECK	£89.17

GRÜN

GRÜN TORCH COMPLETE KIT

The handgrip with solid brass workmanship to withstand the workload. The controls give graduated adjustable working flame. Tube manufactured from strengthened, nickel plated, steel pipe. Extra strong screw threads. Unbreakable heads manufactured from refined stainless steel. Includes 5m hose and 0-4 bar regulator.



Code	Description	Sale Price
GRU200	GRÜN 200/45 TORCH COMPLETE KIT	£144.81
GRU300	GRÜN 350/45 TORCH COMPLETE KIT	£146.34
GRU600	GRÜN 600/45 TORCH COMPLETE KIT	£155.99

GRÜN SUPER TURBO DRYER



Code	Description	Sale Price
GRUNDRYER	GRÜN SUPER TURBO DRYER	£300.00

GRÜN TORCH ONLY



Code	Description	Sale Price
GRU2	GRÜN 200/45 TORCH ONLY	£115.00
GRU3	GRÜN 350/45 TORCH ONLY	£115.00
GRU4	GRÜN 600/45 TORCH ONLY	£124.50

GRÜN TITANIUM TORCH

Small:

100mm arm.
50mm head/burner.

Large:

500mm arm.
50mm head/burner.



Code	Description	Sale Price
GRU7	GRÜN SMALL TITANIUM TORCH	£225.00
GRU8	GRÜN LARGE TITANIUM TORCH	£251.50

**The handgrip with solid brass workmanship to withstand the workload.
The controls give graduated adjustable working flame.
Extra strong screw threads.**



GRÜN GAS TORCHES

Code	Description	Sale Price
GRU62	GRÜN 2 HEADED TORCH/HANDLE/NECK TUBE	£176.00
GRU62COMP	GRÜN 2 HEADED TORCH KIT INCLUDING TORCH/HANDLE/NECK TUBE/HOSE/REGULATOR	£200.00
GRU64	GRÜN 4 HEADED TORCH/HANDLE/NECK TUBE	£233.33
GRU64COMP	GRÜN 4 HEADED TORCH KIT INCLUDING TORCH/HANDLE/NECK TUBE/HOSE/REGULATOR	£279.00



GRÜN NECK TUBE



Code	Description	Sale Price
GRU0101	GRÜN 100mm NECK TUBE	£18.25
GRU20	GRÜN 200mm NECK TUBE	£18.90
GRU35	GRÜN 350mm NECK TUBE	£21.00
GRU60	GRÜN 600mm NECK TUBE	£24.99

GRÜN TORCH HANDLE



Code	Description	Sale Price
GRU01	GRÜN TORCH HANDLE	£62.95
GRUREPAIR	GRÜN TORCH HANDLE REPAIR KIT	£9.85

Torch handle made with high quality brass fittings.

GRÜN BURNER HEAD



Code	Description	Sale Price
GRU06	GRÜN 35mm BURNER HEAD	£27.75
GRU07	GRÜN 45mm BURNER HEAD	£29.99
GRU08	GRÜN 55mm BURNER HEAD	£33.95
GRU09	GRÜN 65mm BURNER HEAD	£38.90

GRÜN BURNER BOX EXCLUSIV



Code	Sale Price
GRUNBOX	£1250.00

- 1 Universal burner U 55, 72,2 kW complete with handle and burner pipe 500mm long = 800mm total length and spring support
- 1 Burner head St 65mm Ø, 119,4 kW with burner pipe 500mm and spring support
- 1 Burner head S 45mm Ø, 44,6 kW with burner pipe 200mm and spring support
- 1 Burner head A 25mm Ø, 9,2 kW with burner pipe 100mm and spring support
- 1 Wide beam burner head K 35, 13,3 kW for seam weldings
- 1 Handle with fast-switch-automatics
- 1 High-pressure hose 6,3 x 5mm, 5 m long, bilateral 3/8" left
- 1 Medium pressure regulator 4 bar with integrated hose failure valve
- 1 Gas lighter, 1 can spare-flints
- 1 Hose connector bilateral 3/8" left
- 1 Felt puller
- Face spanner each SW 30, SW 19/22, SW 17/19, SW 14/15
- 1 Screwdriver, 1 pair working gloves

SIEVERT®

SIEVERT TORCH COMPLETE KIT

A professional and powerful torch kit, ideal for soft soldering, brazing, melting, metalworks, paintstripping and other heating jobs. Includes 5m hose and 0-4 bar regulator.



Code	Description	Sale Price
HA180/44COMP	SIEVERT DETAIL TORCH COMPLETE KIT	£187.00
HA350/44COMP	SIEVERT MEDIUM TORCH COMPLETE KIT	£206.00
HA500/44COMP	SIEVERT LARGE TORCH COMPLETE KIT	£216.00
HA180/44	SIEVERT DETAIL TORCH	£155.69
HA350/44	SIEVERT MEDIUM TORCH	£166.00
HA500/44	SIEVERT LARGE TORCH	£171.00

SIEVERT®



Code	Description	Sale Price
HA3509	SIEVERT 180mm NECK TUBE	£27.00

SIEVERT®



Code	Description	Sale Price
HA3510	SIEVERT 350mm NECK TUBE	£39.02

SIEVERT®



Code	Description	Sale Price
HA3507	SIEVERT 500mm NECK TUBE	£45.67

SIEVERT®



Code	Description	Sale Price
HA3444	SIEVERT SMALL TORCH ECONOMY	£70.83
HA3460	SIEVERT LARGE TORCH ECONOMY	£74.17

SIEVERT®



Code	Description	Sale Price
HA2960	SIEVERT 60mm LARGE BURNER	£57.48

SIEVERT®



Code	Description	Sale Price
HA2944	SIEVERT 42mm MEDIUM BURNER	£38.48

SIEVERT®

SIEVERT TORCH COMPLETE KIT ECONOMY

A professional and powerful torch kit, ideal for soft soldering, brazing, melting, metalworks, paintstripping and other heating jobs. Includes 5m hose and 0-4 bar regulator.

Please note these are factory assembled and parts are non-interchangeable.



Code	Description	Sale Price
HA3444COMP	SIEVERT SMALL TORCH COMPLETE KIT ECONOMY	£114.00
HA3460COMP	SIEVERT LARGE TORCH COMPLETE KIT ECONOMY	£117.00
HA3444	SIEVERT SMALL TORCH ECONOMY	£70.83
HA3460	SIEVERT LARGE TORCH ECONOMY	£74.17



Code	Description	Sale Price
1811	TORCH STANDS	£5.50

SIEVERT®



Code	Description	Sale Price
HA3488	SIEVERT HANDLE C/W VALVE	£95.83



Code	Description	Sale Price
1812	2 PRONG TORCH ADAPTOR	£27.00



Code	Description	Sale Price
1813	4 PRONG TORCH ADAPTOR	£43.50

SIEVERT SAFE2TORCH KIT

Code	Description	Sale Price
HA336630	SIEVERT SAFE2TORCH KIT	£440.00

Includes

- 1x Sievert Promatic handle
- 1x Promatic 600mm neck (60mm burner)
- 1x Promatic 250mm neck (40mm burner)
- 1x Regulator
- 1x 4m hose
- 1x Torch stand
- 1x Tool bag





Code	Description	Sale Price
1822	10" ADJUSTABLE SPANNER	£9.44
1825	FULLY FORGED GAS SPANNER	£8.67



Code	Description	Sale Price
1816B	0-4bar CROWN TOP REGULATOR	£20.22
1816E	0-2 bar REGULATOR	£22.21
1816A	IRISH FIT PROPANE REGULATOR	£25.33



Code	Description	Sale Price
1821	SPARE FLINTS PER 10	£4.42
1820	FLINT LIGHTER	£4.67



Code	Description	Sale Price
1802	NUT AND TAIL	£5.22



Code	Description	Sale Price
1819	PIGTAIL	£17.99
1818	'T' MANIFOLD	£18.93



Code	Description	Sale Price
830	9KG PRESSURE SEAM ROLLER	£178.33



Code	Description	Sale Price
1823	7/16" & 1/2" SCAFFOLD SPANNER	£21.99



Code	Description	Sale Price
1816D	PROPANE FLASHBACK ARRESTOR	£45.72



Code	Description	Sale Price
1817	EXCESS FLOW VALVE	£48.50



Code	Description	Sale Price
1707	HOSE CLIPS BOX QUANTITY 10	£1.03 Each



Code	Description	Sale Price
GRUROLLPLUS	FELT PULLER EXTENDABLE	£111.67

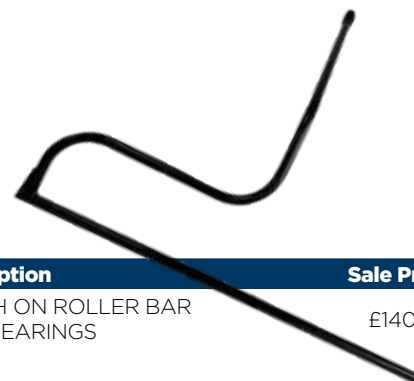

Code	Description	Sale Price
3208	TORCH ON ROLLER BAR C/W BEARINGS	£140.00

GRÜN



Code	Description	Sale Price
QR01GRU	GRÜN QUICK RELEASE HOSE CONNECTOR	£48.33



Code	Description	Sale Price
GEMSTEEL	STEEL SEAM ROLLER RADIUS EDGE	£49.15
GEMSTEEL100	STEEL SEAM ROLLER 100mm	£49.15



Code	Description	Sale Price
829	SEAM ROLLER	£9.58



Code	Description	Sale Price
GEMVEE	NYLON VEE ROLLER	£34.00



Code	Description	Sale Price
EDM134655	90mm SILICONE SEAM ROLLER	£73.68



Code	Description	Sale Price
GEMTEFLON	28mm TEFLON SEAM ROLLER	£49.15



Code	Description	Sale Price
GEMCOMBI	45mm SILICONE/6mm BRASS PENNY COMBINATION ROLLER	£49.15
GEMPEN	SINGLE PLY PENNY ROLLER 5mm	£34.00



Code	Description	Sale Price
1824	HOSE REPAIR KIT	£5.59



Code	Description	Sale Price
SILRUBSEAM90	SILICONE RUBBER SEAM ROLLER 90mm	£49.15
SILRUBSEAM	SILICONE RUBBER SEAM ROLLER	£49.15



Code	Description	Sale Price
EDM134755	STEEL PRESSURE ROLLER 40mm WIDE	£55.95
EDM134855	STEEL PRESSURE ROLLER 60mm WIDE	£61.57



LEISTER TRIAC 'AT' HOT AIR GUN

The TRIAC AT is an intelligent hot-air hand tool for welding and shrinking plastics that is suitable for on-site use. It is designed for the needs of even the most demanding professional. Every tool undergoes stringent quality checks prior to leaving the factory in Switzerland. This high-quality hot-air hand tool is equipped for all situations. Its universal areas of application are virtually unlimited. The TRIAC AT will continue to prove its merit in any weather condition and is just as effective outside as it is indoors - all during continuous operation.

Key Features

- Suitable for the work site.
- Closed loop controlled temperature.
- Open loop controlled air volume.
- Intelligent «e-Drive» operating unit.
- Ergonomic handling.
- Modern design.
- Swiss made.

Code	Description	Sale Price
TRIAC"S"	LEISTER TRIAC "AT" HOT AIR GUN	£822.17



Code	Description	Sale Price
ELE1	REPLACEMENT ELEMENT (AT/ST)	£100.17



Code	Description	Sale Price
GEM40mm	HOT AIR 40mm WELDING NOZZLE	£49.15
GEM40ANGLE	HOT AIR 40mm ANGLED NOZZLE	£49.15



Code	Description	Sale Price
REEL25M	25M EXTENSION REEL - 2 OUTLET 110V	£57.50
REEL25M13	25M EXTENSION REEL - 2 OUTLET 240V	£57.50



Code	Description	Sale Price
GEM20mm	HOT AIR 20mm WELDING NOZZLE	£49.15
GEM20ANGLE	HOT AIR 20mm WELDING NOZZLE	£49.15



Code	Description	Sale Price
GEM20-90ANGLE	20mm 90deg ANGLE WELDING NOZZLE	£49.15



Code	Description	Sale Price
HA238101	SIEVERT JET ANTI-FLARE BLOW TORCH (NO GAS)	£38.33
HA220383	SIEVERT BUTANE/PROPANE GAS CARTRIDGE EN417 175g	£4.92



Code	Description	Sale Price
TAYBLO	TH2000 BLOW LAMP BOX QUANTITY 10	£42.50 Each
TAYREF	REFILL BOX QUANTITY 12	£7.50 Each



Code	Description	Sale Price
MAPPTORCH	MAPP QUICK PRO AUTO START POWER TORCH	£53.33



Code	Description	Sale Price
MAPPGAS	MAPP PROMAX GAS - YELLOW HIGH PERFORMANCE - 1600°C	£23.92
MAPPRO	MAPP PROPANE - BLUE	£16.92

WILL FIT ON EXTENDING POLE



Code	Description	Sale Price
GEMPR1	PRO SEAM TESTER RETRACTABLE	£34.00



Code	Description	Sale Price
GEMPR	SINGLE PLY SEAM TESTING PROBE	£34.00



Code	Description	Sale Price
GEMDEC	DECORATORS SCISSORS	£8.50
GEMSCISSOR	10" MEMBRANE SHEARS	£25.82



NEW

Code	Description	Sale Price
GEMSLIT	ROOF MEMBRANE SLITTING TOOL	£10.83



ABOUT GRÜN AND GRÜN BOILERS

Grün began business in 1919 with basic bitumen pump boilers to meet the needs of roofers. Grün has since developed a comprehensive range of best in class specialised machinery and devices for flat roof construction, roof renovations and the construction sector. The products use state-of-the-art technology that is practical and user-friendly; of high quality, safe and

efficient - allowing craftsmen to work quickly, safely and reliably at all times.

Their aim is to provide contractors with efficient and safe products that reduce costs and keep people safe.

For these reasons we have re-launched our Bitumen Boiler range with these exceptional products.

SAFE RELIABLE EFFICIENT

Grün propane bitumen boilers are the product of years of experience in the manufacture of bitumen boilers. The construction and fitting of the equipment represents the latest technology:

- **Robust design** - built to withstand the rigours of building sites.
- **Heating system** - without internal heating tubes to ensure a high melting capacity using only small amounts of gas.

- **Cost efficiency** - a high degree of firing efficiency and double casing insulation is safe and clean. Both the energy-saving heating technique and the cleanliness of combustion have been confirmed by a State approved testing institution in W. Germany.
- **Modular construction** ensures easy deconstruction without any tools and exchange of parts within boilers of the same size without any problems (also reducing transporting difficulties).

GRÜN BITUMEN BOILER WITH TAP & INSULATION

ADVANTAGES:

- **Unique heating system** provides high melting capacity and efficient gas consumption.
- **Modular construction** enables easy breakdown; boiler part exchange and transport.
- **Rigid construction** and strong, long lasting steelplate for building site use.
- **Even heat distribution** with windshielded vortex beam and row burners.
- **Hand-operated burners** as standard.
- No heating tubes for easy cleaning.
- **30+ gallon capacity** can be fitted with a dial thermometer if required.
- **Automatic control** of thermostatic burner via adjustable valve to regulate gas discharge.



Code	Description	Sale Price
GRU30	33 GALLON PRIMAT 150 BITUMEN BOILER & BURNER	£2834.00
GRU50	55 GALLON PRIMAT 250 BITUMEN BOILER & BURNER	£3169.00

GRU30 PRIMAT 150 BOILER	
Capacity	approx. 150 ltr (33 gal)
Bitumen through-put	200 ltr (44 gal/h)
Max. propane consumption	approx. max. 2.5kg/h
Operating pressure	1.5 bar
Weight	136kg

GRU50 PRIMAT 250 BOILER	
Capacity	approx. 250 ltr (55 gal)
Bitumen through-put	300 ltr (66 gal/h)
Max. propane consumption	approx. max. 3.9kg/h
Operating pressure	1.5 bar
Weight	162kg

Optional thermostatic control unit and hose and regulator separate.

GRÜN ROUND BITUMEN BOILER WITH TAP

This round bitumen boiler is an especially sturdy design.

ADVANTAGES:

- **Wind shielded, manually operate propane vortex beam burner** guarantees high melting efficiency.
- **Fitted with Grün automatic thermostatic control** for regulation of the burner (upon request).
- **Automatic temperature control** of the melting material by thermometer built into the control attachment.
- **Further engineering features** include the special exhaust gas chimney, double jacket insulation, and removable tub without internal heating tubes.
- Bitumen is removed with the built-in lockable drain tap.



1.5 BAR FUEL EFFICIENT

Code	Description	Sale Price
GRU119	119 LITRE/26 GALLON ROUND BITUMEN BOILER AND BURNER - REKORD 119	£2453.33

GRU119 REKORD 119	
Capacity	approx. 119 ltr (26 gal)
Bitumen through-put	180 ltr (40 gal/h)
Max. propane consumption	approx. max. 2.5kg/h
Operating pressure	1.5 bar
Weight	86kg

Optional thermostatic control unit and hose and regulator separate.

A similarly designed 50 gallon round boiler with throughput of 62 gallon per hour is available - pricing on request - REKORD 229.

HAND AND MECHANICAL AGITATING BOILERS

REKORD DIN 119HR, DIN 229HR and DIN 229MR

The DIN 119HR and 229HR special bitumen boilers are supplied with manual agitator incl. flame shield, excl. hose and regulator.

The DIN 229MR special bitumen boiler is supplied with electric motor agitator including flame shield, excluding hose and regulator. **With indirect heating and the agitator, these modified boilers are particularly suitable for polymer bitumen.**

CALL US FOR FURTHER INFORMATION AND PRICES

REKORD DIN 119HR with manual agitator	
Capacity	approx. 119 ltr (26 gal)
Burner heat output	32 kW
Weight	102kg

REKORD DIN 229HR with manual agitator	
Capacity	approx. 229 ltr (50 gal)
Burner heat output	50 kW
Weight	145kg

REKORD DIN 229MR with electric motor	
Capacity	approx. 229 ltr (50 gal)
Burner heat output	50 kW
Weight	200kg



IDEAL FOR POLYMER BITUMEN

1.5 BAR FUEL EFFICIENT

GRÜN 4.2 GALLON BUCKET HEATER & BUCKET

GRÜN REKORD 19

High-performance small bitumen boilers with removable bucket.

ADVANTAGES:

- Estimated to run at 100% more efficiency than the older style boilers.
- Heating via a windshielded propane vortex beam burner.
- Construction and fitting comply with the regulations of the German Bau-Berufsgenossenschaft (construction liability insurance).
- Bucket can be easily pulled out and used as a separate bucket and replacements are sold separately.
- Can be used for safe carrying of hot melt liquids with the lid covering the bucket and pouring lid for extra safety.
- The bucket can be locked in place to the boiler base for extra safety.



Code	Description	Sale Price
GRU19	19 LITRE/4.2 GALLON SAFETY FIRST BUCKET HEATER & BUCKET (COMES WITH BURNER)	£491.67
GRU19BUCKET	BUCKET	£160.00
GRU19LID	BUCKET LID	£50.00
GRU19B	BURNER	£160.00

GRU19 REKORD 19

Capacity	approx. 19 ltr (4.2 gal)
Bitumen through-put	40 ltr (9 gal/h)
Max. propane consumption	approx. max. 0.6kg/h
Operating pressure	1.5 bar
Weight	13kg

GRÜN 11 GALLON BOILER WITH TAP & THERMOMETER

GRÜN REKORD 49

High-performance small bitumen boiler with tap of 11 gallon capacity.

ADVANTAGES:

- Estimated to run at 100% more efficiency than the older style boilers.
- Heated via windshielded propane vortex beam burner.
- Construction and fitting comply with the regulations of the German Bau-Berufsgenossenschaft (construction liability insurance).
- Features include lockable hinged lid, lockable drain cock, double jacket insulation and a dial thermometer for temperature control.
- Many safety features supporting site risk assessment and reduced liability.
- Burners are reliable and not prone to any part or complete replacement
- Tested and certified and comes with operating instructions and product liability cover.



Code	Description	Sale Price
GRU49	49 LITRE/11 GALLON BITUMEN BOILER WITH TAP - REKORD 49 (COMES WITH BURNER)	£1082.34
GRU49B	BURNER FOR REKORD 49	£208.34

GRU49 REKORD 49

Capacity	approx. 49 ltr (11 gal)
Bitumen through-put	100 ltr (22 gal/h)
Max. propane consumption	approx. max. 0.6kg/h
Operating pressure	1.5 bar
Weight	49kg

GRÜN 11 GALLON TILT BOILER GRÜN KIPP 50

A small manageable boiler with lockable lid fits through almost any roof-hole and is excellently suited for repair work and small jobs as well as hot melt work.

ADVANTAGES:

- Estimated to run at 100% more efficiency than the older style boilers.
- **High powered propane** beam burner for rapid heating up period.
- Can be fitted with a dial thermometer for temperature control.
- Bitumen/Hot Melt is poured by tilting the boiler in the tilting frame.
- Many safety features supporting site risk assessment and reduced liability.
- Burners are reliable and not prone to part or complete replacement.
- Tested and certified and comes with operating instructions and product liability cover.



1.5 BAR FUEL EFFICIENT

IDEAL FOR VISCOUS HOT MELT

Code	Description	Sale Price
GRUNKIPP	50 LITRE/11 GALLON TILT BOILER - KIPP 50 (WITHOUT THERMOMETER), COMES WITH BURNER	£1084.00
GRUKIPP THERM	50 LITRE/11 GALLON TILT BOILER - KIPP 50 COMES WITH THERMOMETER AND BURNER	£1167.33

GRUKIPP 50	
Capacity	approx. 50 ltr (11 gal)
Bitumen through-put	100 ltr (22 gal/h)
Max. propane consumption	approx. max. 0.8kg/h
Operating pressure	1.5 bar
Weight	38kg

GRÜN THERMOSTATIC CONTROL UNIT (ONLY 30/50 GALLON)

Automatic thermostatic control that is durable and does not require batteries or mains supply.



1.5 BAR FUEL EFFICIENT

Code	Description	Sale Price
GRUTHE	THERMOSTATIC CONTROL UNIT	£1610.00

GRÜN BURNER ONLY

Burner only for use with a GRÜN boiler.



Code	Description	Sale Price
GRU30B	BURNER FOR THE 33 GALLON PRIMAT 150	£305.00
GRU50B	BURNER FOR THE 55 GALLON PRIMAT 250	£401.00
GRU119B	BURNER FOR THE 26 GALLON REKORD 119	£267.00



Simple and effective thanks to a highly absorbent foam roller.

The DRYING ROLL absorbs moisture over large areas and is ready for the next rolling run without releasing the liquid already absorbed. Its ergonomic shape allows for easy emptying by squeezing the foam.

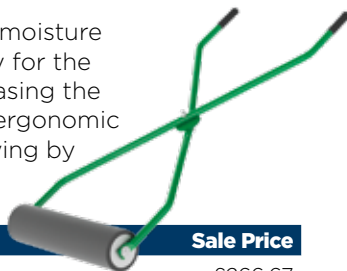

Code	Description	Sale Price
GRUNPUD	DRYING ROLL	£266.67
GRUNPUDREFIL	DRYING ROLL REFILL	£35.00

Code	Description	Sale Price
1510	SMALL TAR LADLE	£33.32
1511	LARGE TAR LADLE	£36.65

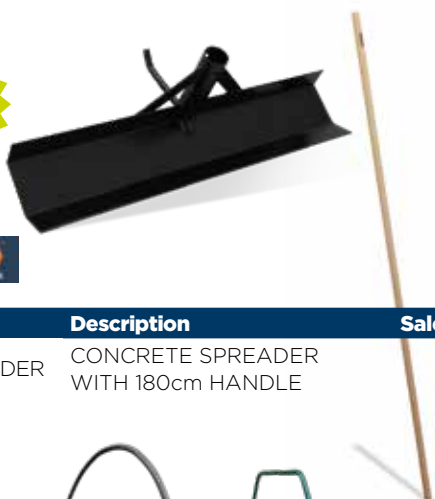

Code	Description	Sale Price
EDMSPREADER	CONCRETE SPREADER WITH 180cm HANDLE	£37.34



Code	Description	Sale Price
1512	ASPHALT BUCKET - DESIGNED TO FIT IN THE GRU19 BUCKET HEATER	£58.33
GRU19BUCKET	GRÜN 19LV LIP BUCKET + LID (INNER BUCKET FOR BUCKET HEATER PAGE 38)	£160.00



Code	Description	Sale Price
1504	LARGE SPOUT POURING CAN	£41.25
1501	V LIP BUCKET	£36.50

Used for taking the temperature of the bitumen in the pot - simple to use and read.



Code	Description	Sale Price
3290	BITUMEN TEMPERATURE PROBE	£241.67



Code	Description	Sale Price
RING	BOILER RING	£69.72



Code	Description	Sale Price
3206	IMPACT BOILER BURNER	£200.00



Code	Description	Sale Price
GRUTRAY1	OVERSPILL TRAY 660mm x 660mm - FOR BITUMEN BOILER UP TO 49 LITRES (NOT SUITABLE FOR KIPP 50)	£242.00
GRUTRAY2	OVERSPILL TRAY 1,300mm x 850mm - FOR BITUMEN BOILERS UP TO 150 LITRES	£325.00
GRUTRAY3	OVERSPILL TRAY 1,700mm x 1000mm - FOR BITUMEN BOILERS UP TO 250 LITRES	£566.67

TRAYS ARE GALVANISED WITH HANDLES



Code	Description	Sale Price
GASCAGE	GAS CAGE (4ft x 4ft x 6ft)	£955.69
GASCAGES	SMALL GAS CAGE 3.3w x 1.7d x 4.7h ft	£565.00
EXTING	1kg FIRE EXTINGUISHER POWDER	£52.40
EXTING2	2kg FIRE EXTINGUISHER POWDER	£59.99



Code	Description	Sale Price
T100	ROOFER BITUMEN REMOVER 1000ml	£29.90



Code	Description	Sale Price
102	CLAW HAMMER 16oz STEEL SHAFT BOX QUANTITY 6	£8.25 Each



Code	Description	Sale Price
103	CLAW HAMMER FULLY FORGED 20oz BOX QUANTITY 6	£14.85 Each



Code	Description	Sale Price
114	ESTWING CLAW HAMMER 16oz BLUE GRIP	£58.84 Each
114E320C	ESTWING CLAW HAMMER 20oz BLUE GRIP	£64.32 Each
114E324C	ESTWING CLAW HAMMER 24oz BLUE GRIP BOX QUANTITY 2	£78.65 Each



Code	Description	Sale Price
117	ESTWING SLATERS PICK BOX QUANTITY 2	£72.99 Each



Code	Description	Sale Price
114E16C	ESTWING CLAW HAMMER 16oz LEATHER GRIP	£71.28
114E20C	ESTWING CLAW HAMMER 20oz LEATHER GRIP	£81.61



Code	Description	Sale Price
102F	CLAW HAMMER - 16oz FIBREGLASS SHAFT	£7.85



Code	Description	Sale Price
108	SLATERS HAMMER STEEL SHAFT	£26.19
107	SLATERS HAMMER WOODEN SHAFT	£33.99



Code	Description	Sale Price
127	PICK HEAD CHISEL & POINT	£13.11



Code	Description	Sale Price
128	MATTOCK HEAD	£14.59



Code	Description	Sale Price
129	PICK/MATTOCK SHAFT	£9.83



Code	Description	Sale Price
104	CLUB HAMMER 2.5lb BOX QUANTITY 4	£11.12 Each



Code	Description	Sale Price
601	3" BOLSTER CHISEL	£7.00
602	4" BOLSTER CHISEL	£7.67



Code	Description	Sale Price
604	PLUGGING CHISEL	£5.33



Code	Description	Sale Price
802	COTTON BRICK LINE	£1.78



Code	Description	Sale Price
0609	EDMA MAX LINE 50m	£37.50 Each



Code	Description	Sale Price
0318	EDMA HAMMER TACKER (10/12/14mm STAPLES). BOX QUANTITY 5	£47.95 Each
1301ARR	ARROW HT50P HEAVY DUTY HAMMER TACKER. BOX QUANTITY 6	£65.54 Each
1301G	HEAVY DUTY HAMMER TACKER	£42.50 Each



Code	Description	Sale Price
1304A	10mm ECO STAPLES PER 1000	£3.07 Each
1304	12mm ECO STAPLE PER 1000 BOX QUANTITY 5	£3.07 Each



Code	Description	Sale Price
607	18" WRECKING BAR	£5.90
608	24" WRECKING BAR	£7.35
609	30" WRECKING BAR	£7.99
PRYBAR	16" UTILITY BAR	£8.49



Code	Description	Sale Price
804L	LONGO CHALK LINE (30mtrs) BOX QUANTITY 12	£9.17 Each



Code	Description	Sale Price
804R	MAXI LINE BOX QUANTITY 12	£19.08 Each



Code	Description	Sale Price
806MB	BLUE CHALK FLASK	£6.20 Each
806MR	RED CHALK FLASK	£6.20 Each
806MW	WHITE CHALK FLASK	£6.20 Each
806F	FLUORESCENT ORANGE CHALK FLASK BOX QUANTITY 12	£6.20 Each



Code	Description	Sale Price
1303A	10mm TACWISE STAPLES PER 2000	£5.37 Each
1303	12mm TACWISE STAPLES PER 2000 BOX QUANTITY 10	£5.37 Each



Code	Description	Sale Price
805	ROOFER MARKING PENCILS PER 3 BOX QUANTITY 12	£2.00 Each



Code	Description	Sale Price
1302	STAPLE GUN	£15.25



Code	Description	Sale Price
420	7.5m ROOFER TAPE MEASURE HI-VIS BOX QUANTITY 6	£7.27 Each



Code	Description	Sale Price
402F	5m ROOFER TAPE MEASURE HI-VIS BOX QUANTITY 12	£3.99 Each



Code	Description	Sale Price
402A	STANLEY POCKET TAPE 5m/16ft BOX QUANTITY 2	£10.25 Each



Code	Description	Sale Price
410	1m FOLDING RULE PLASTIC BOX QUANTITY 12	£7.85 Each



Code	Description	Sale Price
01F	FLAT SCREWDRIVER BOX QUANTITY 6	£2.92 Each



Code	Description	Sale Price
400	24" SPIRIT LEVEL	£16.01



Code	Description	Sale Price
01X	CROSS DRIVER BOX QUANTITY 6	£2.92 Each



Code	Description	Sale Price
205	GAUGING TROWEL ECONOMY BOX QUANTITY 12	£4.58 Each



Code	Description	Sale Price
200	RST TILING TROWEL	£5.50



Code	Description	Sale Price
208	MASTIC TROWEL BOX QUANTITY 12	£3.03 Each



Code	Description	Sale Price
201	BRICK TROWEL ECONOMY BOX QUANTITY 12	£4.98 Each



Code	Description	Sale Price
210	ASPHALT POT TROWEL	£20.19



Code	Description	Sale Price
202	TYZACK GAUGING TROWEL (WHS) BOX QUANTITY 10	£25.75 Each



Code	Description	Sale Price
211	ASPHALT MARGIN TROWEL	£13.08



Code	Description	Sale Price
203	POINTING TROWEL ECONOMY BOX QUANTITY 12	£4.42 Each



Code	Description	Sale Price
209TYZ	TYZACK ASPHALT TROWEL	£31.28



Code	Description	Sale Price
820	3" PRO SCRAPER STANDARD	£8.28 Each
821	4" PRO SCRAPER STANDARD	£9.36 Each
BOX QUANTITY 6		



Code	Description	Sale Price
EDM276755	EDMA STAINLESS STEEL BUCKET SCOOP KNIFE	£8.50



Code	Description	Sale Price
823	1.5" (38mm) FILLING / PUTTY KNIFE	£3.10



SCRAPER & CUTTING TOOL RANGE



Code	Description	Sale Price
EDM164355	EDMA MULTI PURPOSE TOOL	£8.92



Code	Description	Sale Price
EDM164555	EDMA HEAVY DUTY SCRAPER	£10.85

CROCOPLAC II

EDMA JAB SAW WITH TEETH ON BOTH SIDES



Holster included

To cut plasterboard, cellular concrete, wooden panels, etc.. Triple bezel blade and teeth on both sides for multidirectional cutting.

8 teeth per inch.

Trident head to make the pre-holes or metal anchor installation.

Light and easy to handle.

Ergonomic bi-material handle.



Code	Size	Sale Price
EDM067055	150mm	£17.48

EDMA SAFETY KNIFE

Safety carton and plastic film opener.

Double blade not replaceable.



Code	Sale Price
EDM170655	£2.92

EDMA UTILITY KNIFE

With 25mm snap-off blades

3 spare blades included.

Security locking blade action.

Ergonomic and heavy duty design.



Code	Sale Price
EDM160655	£14.63

EDMA SNAP OFF KNIFE WITH ZINC-ALLOY BODY

Available in 2 dimensions:

Code	Size	Sale Price
EDM170355	9mm	£2.90
EDM170455	18mm	£5.08



EDMA FOLDABLE KNIFE

Ergonomic design.

Security locking system.

Quick blade-changing system.

Code	Sale Price
EDM170255	£7.53



EDMA FOLDABLE KNIFE WITH HOLSTER

Foldable knife for trapeze blades and hook blades.

4 blades storage compartment.

Holster included.

Code	Sale Price
EDM060655	£20.01



EDMA DUAL-SYSTEM KNIFE

Cut string integrated.

4 blades in the storage compartment + 1 on the cutter.

Quick blade-changing system.

Soft-touch grip.

Code	Sale Price
EDM170155	£11.31





Code	Description	Sale Price
810	F/B TRIMMING KNIFE - STANLEY BOX QUANTITY 12	£7.08 Each



Code	Description	Sale Price
812	R/B TRIMMING KNIFE - STANLEY BOX QUANTITY 12	£9.80 Each



**FOLDS INTO
COMPACT
SIZE FOR
CONVENIENT
STORAGE**

Code	Description	Sale Price
822	STANLEY FATMAX FOLDING TWIN-BLADE KNIFE BOX QUANTITY 6	£25.94 Each



Code	Description	Sale Price
818	TITAN KNIFE - STANLEY BOX QUANTITY 12	£21.69 Each



Code	Description	Sale Price
819	FISH TAIL TRIMMING KNIFE BOX QUANTITY 6	£6.25 Each



Code	Description	Sale Price
813	STRAIGHT BLADES - PER 10	£2.01 Each
813DISP	100 PACK STRAIGHT BLADE DISPENSER	£18.42 Each
813992	STANLEY STRAIGHT BLADES - PER 5 BOX QUANTITY 20	£2.60 Each



Code	Description	Sale Price
811	R/B TRIMMING KNIFE - ROOFER BOX QUANTITY 12	£4.00 Each



**SET CUTTING
DEPTH
PRECISION
FOR CUTTING
EDGES**

Code	Description	Sale Price
803	PRECISION ROOFING KNIFE	£6.23
816	BOW TIE BLADES - PER 5	£2.58



Code	Description	Sale Price
814	HOOKED BLADES - PER 10	£2.20 Each
814DISP	100 PACK HOOKED BLADE DISPENSER	£18.42 Each
813996	STANLEY HOOKED BLADES - PER 5 BOX QUANTITY 20	£2.60 Each



Code	Description	Sale Price
815	FOLDING KNIFE BOX QUANTITY 12	£10.33 Each

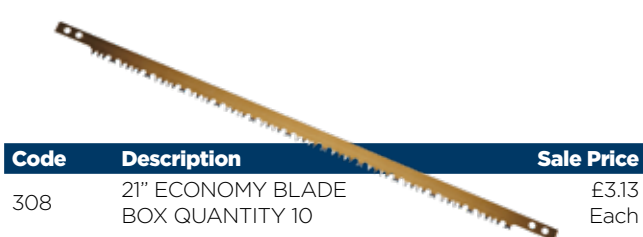

Code	Description	Sale Price
308	21" ECONOMY BLADE BOX QUANTITY 10	£3.13 Each



Code	Description	Sale Price
302	21" BAHCO (SANDVIK) BLADE BOX QUANTITY 10	£7.61 Each



Code	Description	Sale Price
3029	21" BAHCO (SANDVIK) BOWSAW	£20.95

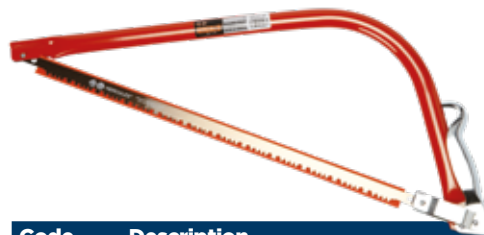

Code	Description	Sale Price
307	21" BOWSAW - ROOFER	£9.33



Code	Description	Sale Price
311	ROOFER HARDPOINT HAND SAW BOX QUANTITY 6	£7.42 Each



Code	Description	Sale Price
306A	JACKSAW - PROFESSIONAL HANDPOINT SAW BOX QUANTITY 10	£12.42 Each



Code	Description	Sale Price
306B	S&J PREDATOR HAND SAW BOX QUANTITY 10	£14.74 Each



Code	Description	Sale Price
306C	S&J 22" PREDATOR HAND SAW FOR UPVC AND FACIA BOX QUANTITY 10	£14.74 Each



Code	Description	Sale Price
306D	S&J 22" PREDATOR HAND SAW TRIPLE CUT BOX QUANTITY 10	£14.74 Each

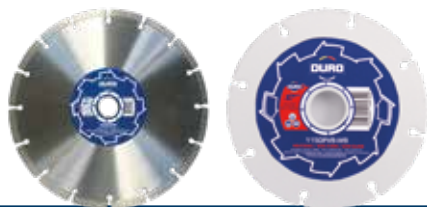

Code	Description	Sale Price
115SPEC	4.5" DIAMOND CUTTING DISC	£8.75
230SPEC	9" DIAMOND CUTTING DISC BOX QUANTITY 10	£16.25 Each
300SPEC	12" DIAMOND CUTTING DISC	£22.92
2109RAKE	4.5" MORTAR RAKING PREMIUM BLADE	£22.50
115CARB	115mm x 22mm CARBIDE WOOD/PVC CUTTING DISC	£11.65
230CARB	230 x 22mm CARBIDE WOOD/PVC CUTTING DISC	£22.92

Code	Description	Sale Price
2109M	FLAT METAL CUTTING DISC 115mm x 22mm	£1.50
2103M	FLAT METAL CUTTING DISC 230mm x 22mm	£3.13
2109	FLAT STONE CUTTING DISC 115mm x 22mm	£1.47
2103	FLAT STONE CUTTING DISC 230mm x 22mm	£3.22



Code	Description	Sale Price
SDS2106	SDS PLUS HAMMER DRILL 6mm x 210mm	£2.10
SDS16065	SDS PLUS HAMMER DRILL 6.5mm x 210mm	£2.20
SDS1607	SDS PLUS HAMMER DRILL 7mm x 210mm	£2.30



Code	Description	Sale Price
TORX	TORX FORGEFIX S2T20 (3 PIECE)	£1.99



Code	Description	Sale Price
PLASPACK	PLASTIC PACKERS ASSORTED (5x10 SHIMS 1mm, 2mm, 3mm, 4mm & 5mm)	£9.15
PLUGRED	RAWL PLUG RED 6mm	£3.75
PLUGBROWN	RAWL PLUG BROWN 7mm	£3.75



Code	Description	Sale Price
001	2 STROKE OIL BOX QUANTITY 10	£4.98 Each

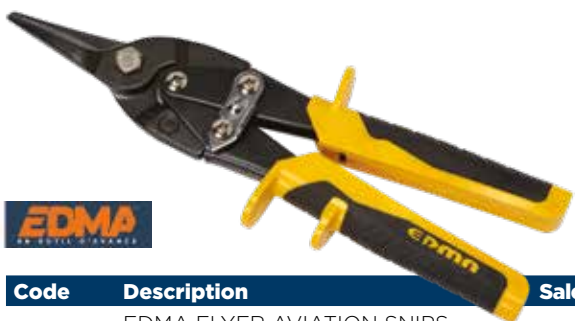

Code	Description	Sale Price
0107	EDMA FLYER AVIATION SNIPS BOX QUANTITY 5	£27.92 Each



Code	Description	Sale Price
502	10" TINSNIPS	£12.67 Each
503	ECLIPSE 10" TINSNIPS BOX QUANTITY 6	£18.92 Each



Code	Description	Sale Price
504	8" GILBOW TINSNIP	£27.42 Each
505	10" GILBOW TINSNIP	£35.55 Each
506	12" GILBOW TINSNIP BOX QUANTITY 6	£38.50 Each



Code	Description	Sale Price
507	LEFT H. GILBOW G67 TINSNIP	£62.40 Each
508	RIGHT H. GILBOW G69 TINSNIP BOX QUANTITY 6	£62.40 Each



Code	Description	Sale Price
SC	STRAPPING CLIPS PER BOX - 2000	£30.83



Code	Description	Sale Price
SE	SEAL APPLY TOOL	£65.83



Code	Description	Sale Price
TE	TENSION TOOL	£99.98



Code	Description	Sale Price
ST	STRAPPING PER 1500m	£58.50



Code	Description	Sale Price
STAND	STRAPPING DISP STAND	£83.32



Code	Description	Sale Price
TAPE	HEAVY DUTY ADHESIVE TAPE	£3.08 Each
2067	DUCT TAPE	£3.80 Each
2068	MASKING TAPE	£2.94 Each
BOX QUANTITY 6		



Code	Description	Sale Price
P100BLACK	HEAVY DUTY BLACK PALLET WRAP 25 MICRON 250m x 580mm BOX QUANTITY 6	£19.27 Each



Code	Description	Sale Price
P100	PALLET WRAP 17 MICRON 300m x 400mm BOX QUANTITY 6	£14.17 Each



Code	Description	Sale Price
2020	No 12 COTTON MOP BAG QUANTITY 10	£1.23 Each



Code	Description	Sale Price
2022	No 14 COTTON MOP BAG QUANTITY 10	£1.74 Each



Code	Description	Sale Price
2008S	10" BASSINE BRUSH HEAD BOX QUANTITY 20	£2.33 Each



Code	Description	Sale Price
2005	10" COCO BRUSH HEAD BOX QUANTITY 20	£2.35 Each



Code	Description	Sale Price
200818	18" BASSINE BRUSH C/W HANDLE	£12.84
2007A	24" BASSINE BRUSH C/W HANDLE	£16.09



Code	Description	Sale Price
200512	12" COCO BRUSH C/W HANDLE	£7.25
200518	18" COCO BRUSH C/W HANDLE	£12.00
2007	24" COCO BRUSH C/W HANDLE	£15.75



Code	Description	Sale Price
2009A	36" BASSINE BRUSH C/W HANDLE	£25.92



Code	Description	Sale Price
2009	36" COCO BRUSH C/W HANDLE	£25.92



Code	Description	Sale Price
2008	BASS YARD BRUSH	£6.58



Code	Description	Sale Price
2041	COCO HAND BRUSH	£2.60 Each
2041A	BASSINE HAND BRUSH BOX QUANTITY 24	£2.90 Each



Code	Description	Sale Price
2028	9" 2-ARM ROLLER FRAME	£8.10
2029	12" 2-ARM ROLLER FRAME	£8.50
2030	9" ROLLER REFILL	£4.40
2031	12" ROLLER REFILL	£5.50



Code	Description	Sale Price
2013	10" HOT MELT SQUEEGEE	£21.33
2014	22" HOT MELT SQUEEGEE	£24.83



Code	Description	Sale Price
2017	18" WATER DOZER BOX QUANTITY 10	£9.56 Each
EDM259955	30" WATER DOZER	£9.66

Code	Description	Sale Price
2018	4FT-15/16" BRUSH STALES	£1.61 Each
2019	4FT-1 1/8 BRUSH STALES	£2.25 Each

BULK QUANTITY 25



Code	Description	Sale Price
POLE	METAL POLE FOR SANDER 1200mm	£5.89



Code	Description	Sale Price
2042	DUST PAN & BRUSH	£4.70



Code	Description	Sale Price
2040	4 ROW WIRE BRUSH BOX QUANTITY 10	£2.25 Each



Code	Description	Sale Price
20001	GORILLA BROOM 500mm C/W SCREW HANDLE AND BUILT IN SCRAPER	£26.47



Code	Description	Sale Price
SPONGE	JUMBO SPONGE BOX QUANTITY 6	£1.50 Each



Code	Description	Sale Price
2015	18" SQUEEGEE C/W HANDLE	£14.09
2016	24" SQUEEGEE C/W HANDLE	£14.67



Code	Description	Sale Price
2033	ROLLER FRAME 230 x 45mm	£2.52



Code	Description	Sale Price
2053	4" MINI ROLLER & TRAY KIT	£3.47



Code	Description	Sale Price
2039	9" PAINT ROLLER C/W FRAME BOX QUANTITY 48	£3.32 Each



Code	Description	Sale Price
2039TRAY	9" PAINT ROLLER C/W TRAY BOX QUANTITY 12	£3.88 Each



Code	Description	Sale Price
2078	4" VELOUR TOPCOAT ROLLER REFILL	£1.15 Each
2080	10" GRP SLEEVE (VELOUR) FOR STRONG ARM	£3.42 Each



Code	Description	Sale Price
2034	ROLLER FRAME FLEECE SLEEVE 230mm BOX QUANTITY 12	£3.08 Each



Code	Description	Sale Price
2010	TURKS HEAD BRUSH	£2.75



Code	Description	Sale Price
2001	PAINTBRUSH 1"	£0.43 Each
2002	PAINTBRUSH 2"	£0.90 Each
2003	PAINTBRUSH 3"	£1.07 Each
2004	PAINTBRUSH 4"	£1.71 Each

BOX QUANTITY 12



Code	Description	Sale Price
2035	12" PAINT SKUTTLE	£6.68
2036	GRP MINI SKUTTLE	£2.78



Code	Description	Sale Price
SAND60	DECORATORS ROLLS 115mm x 5m 60 GRIT	£5.99 Each
SAND80	DECORATORS ROLLS 115mm x 5m 80 GRIT	£5.99 Each
SAND120	DECORATORS ROLLS 115mm x 5m 120 GRIT	£5.99 Each

BOX QUANTITY 6



Code	Description	Sale Price
EDM277955	EDMA PRECISION SCRAPER + 7 BLADES	£27.12



Code	Description	Sale Price
EDM164555	EDMA HEAVY DUTY SCRAPER	£10.85



Code	Description	Sale Price
EDM164355	EDMA MULTI PURPOSE TOOL	£8.92



Code	Description	Sale Price
EDM276755	EDMA STAINLESS STEEL BUCKET SCOOP KNIFE	£8.50



Code	Description	Sale Price
EDM610161	EDMA SET OF PREMIUM JOINT KNIVES + STORAGE POUCH	£95.31



Code	Description	Sale Price
EDM610160	EDMA SET OF JOINT KNIVES + STORAGE POUCH	£82.41



Code	Description	Sale Price
1513	FLEXITUB	£10.67



Code	Description	Sale Price
1507	PLASTIC BUCKET	£2.09
1522	YELLOW BUCKET	£2.99



Code	Description	Sale Price
1512	ASPHALT BUCKET - DESIGNED TO FIT IN THE GRU19 BUCKET HEATER	£58.33
GRU19BUCKET	GRÜN 19LV LIP BUCKET + LID (INNER BUCKET FOR BUCKET HEATER PAGE 38)	£160.00



Code	Description	Sale Price
1521	REAL RUBBER BUCKET	£20.83



Code	Description	Sale Price
1514	RUBBER 4 HAND TRUG	£33.32



Code	Description	Sale Price
1520	ROOFER RIDGE BUCKET	£13.71



Code	Description	Sale Price
FS	EDMA 300mm SCRAPER INC HANDLE	£21.67



Code	Description	Sale Price
1517	TUFSPOT MIXING TRAY	£26.58



Code	Description	Sale Price
B100	PNE WHEELBARROW STOCKS HELD BUT CARRIAGE MAY APPLY	£73.34



Code	Description	Sale Price
SACK	ROBUST TUBULAR FRAME, PNEUMATIC ALL TERRAIN WHEELS WITH SEALED BEARINGS. MAX CAPACITY 315kg	£85.00



Code	Description	Sale Price
2069	POWER WHISK	£3.74



Code	Description	Sale Price
2700	ZEBRA TAPE	£15.83



Code	Description	Sale Price
2706	10mm COIL ROPE 220m LONG	£50.81
2708	6mm COIL ROPE 220m LONG	£31.50



Code	Description	Sale Price
2704	LORRY ROPE 90ft APPROX 10mm DIA	£7.79



Code	Description	Sale Price
1601	BULLDOG 5SM2AM SHOVEL	£38.34
1603	GENERAL PURPOSE SHOVEL O/S	£19.92
1604A	CARTER ALL STEEL STRIPPING SPADE	£32.50
1605	CARTER WIDE BLADE STRIPPING SPADE	£40.83



Code	Description	Sale Price
2705	LORRY ROPE 90ft APPROX 6mm DIA	£6.20



Code	Description	Sale Price
SI01	HEAVY DUTY REFUSE SACKS PER 100	£39.20



Code	Description	Sale Price
2703	5.4m x 3.6m TARPAULIN PLASTIC	£14.37
2707	5.5m x 7.0m TARPAULIN PLASTIC	£21.75



Code	Description	Sale Price
SHEET	COTTON DUST SHEET 2.7m x 3.6m	£8.33
SHEETPLAS	PLASTIC BACKED DUST SHEET 2.7m x 3.6m	£12.25



Code	Description	Sale Price
STOCKIN	STOCKINETTE (400g)	£5.17



Code	Description	Sale Price
SI02	1 TONNE BAG	£6.65



Code	Description	Sale Price
RATCH25	25mm X 4m HEAVY DUTY RATCHET (800kg CAPACITY)	£5.99



Code	Description	Sale Price
RATCHET	2" RATCHET LORRY TIE DOWN BOX QUANTITY 4	£12.59 Each



Code	Description	Sale Price
RATSMALL	SMALL TIE DOWN STRAPS	£4.00



Code	Description	Sale Price
CT30048B	300mm x 4.8mm CABLE TIE BLACK (100s)	£3.55
CT30048	300mm x 4.8mm CABLE TIE CLEAR (100s)	£3.55



Code	Description	Sale Price
BUN	48" BUNGEE STRAP WITH HOOK	£2.61
BUNSET	4 PIECE 12mm GS/TUV BUNGEE SET	£6.00



Code	Description	Sale Price
EVER404	MOSS & MOULD REMOVER 5L	£7.99
EVERADMIX	MORTAR ADMIXTURE 5L	£3.92
FROST5	FROST PROOFER & ACCELERATOR	£6.15



Code	Description	Sale Price
MPURE	PU TILE ADHESIVE BOX QUANTITY 12	£6.10 Each



Code	Description	Sale Price
827	MASTIC/SKELETON GUN BOX QUANTITY 24	£4.12 Each



Code	Description	Sale Price
827A	POWER PLUS MASTIC GUN BOX QUANTITY 6	£10.99 Each



Code	Description	Sale Price
WIPE	100 WIPES PER TUB	£7.05



Code	Description	Sale Price
827B	TECNIC FOIL GUN FOR 600ml CARTRIDGE	£40.00



Code	Description	Sale Price
SURVEY	SURVEY SPRAY PAINT	£9.98



Code	Description	Sale Price
1402	ROOFER KNEEPAD LEATHER/RUBBER	£19.67



Code	Description	Sale Price
1406	MINERS KNEEPADS	£40.83



Code	Description	Sale Price
1403	ROOFER KNEEPAD RUBBER/RUBBER	£19.67



Code	Description	Sale Price
1413	ROOFER ASPHALTER KNEEPAD	£51.62



Code	Description	Sale Price
1401	VITREX MINI GEL	£19.17
1415	PREMIUM GEL FILLED KNEE PADS	£16.65



Code	Description	Sale Price
1400	KNEEPAD SPARE STRAP	£2.92
1400LEATHER	LEATHER QUALITY SPARE KNEEPAD STRAP	£4.22



Code	Description	Sale Price
1404	LEATHER BELT	£8.99



Code	Description	Sale Price
1405	HAMMER LOOP - STEEL	£6.77



Code	Description	Sale Price
1411	PREMIER F/F OIL TAN NAIL POUCH C/W BELT	£35.83



Code	Description	Sale Price
1407	PREMIER OIL TAN MULTI-POCKET D/COMBI C/W BELT	£45.00



Code	Description	Sale Price
1418	PREMIER 3 POCKET OIL TAN NAIL POUCH C/W BELT (MINI COMBI)	£38.34



Code	Description	Sale Price
1442	PREMIER CORDURA D/COMBI C/W LEATHER BELT (LEATHER LINED POCKETS)	£50.00



Code	Description	Sale Price
1443	PREMIER CORDURA F/F C/W LEATHER BELT	£41.67



Code	Description	Sale Price
1417	ROOFER NAIL POUCH - KANGAROO	£36.00



1408	OIL TAN NAIL MULTI POCKET D/COMBI C/W BELT	£32.50
------	--	--------

Code	Description	Sale Price
1404A	2" PREMIER LEATHER BELT	£15.84
1404B	3" PREMIER LEATHER BELT	£20.00



Code	Description	Sale Price
1410	LEATHER NAIL & TOOL POUCH	£16.94
1409	LEATHER NAIL MULTI POCKET D/COMBI C/W BELT	£13.58



Code	Description	Sale Price
1441	CORDURA POUCH FRONT TO FRONT	£20.04
1440	CORDURA MULTI POCKET D/COMBI C/W BELT	£30.65



Code	Description	Sale Price
SUITXL	DISPOSABLE OVERALL	£7.99

Code	Description	Sale Price
2610	PVC RAINSUIT	£23.25
FLO	FLO HIGH GLOW WAIST COAT (XL)	£4.30



Code	Description	Sale Price
2601	GP GOGGLES	£2.92
2603	SAFETY GLASSES	£4.50



Code	Description	Sale Price
2606	SAFETY HELMET BLUE	£7.08
2606Y	SAFETY HELMET YELLOW	£7.08
2606W	SAFETY HELMET WHITE	£7.08



Code	Description	Sale Price
2602	EAR DEFENDER	£6.85



Code	Description	Sale Price
1202	PVC KNITTED WRIST GLOVES	£1.42 Each
1206	GRIPPER GLOVES OPEN BACK	£2.56 Each

BAG QUANTITY 10



Code	Description	Sale Price
1207	THERMAL GLOVES	£4.69 Each
1208	ROOFER SKIN GLOVES	£3.15 Each

BAG QUANTITY 10

NEW PREMIUM GLOVE RANGE





Code	Description	Sale Price
1412	24" TOOLBAG	£6.58



Code	Description	Sale Price
TOOL1	28" YELLOW TROLLEY TOOLBAG	£83.33
TOOL4	24" YELLOW TROLLEY TOOLBAG	£58.33
TOOL5	16" YELLOW TROLLEY TOOLBAG	£40.00



Code	Description	Sale Price
EDM743006	EDMA STACKABLE STORAGE BOX	£85.65



Code	Description	Sale Price
2620	FFP3 RESPIRATOR	£2.50 Each



Code	Description	Sale Price
1200	SURETOUCH GLOVES 100 PER BOX	£13.75



Code	Description	Sale Price
TOOL2	28" BROWN LEATHER TROLLEY TOOLBAG	£100.00
TOOL3	24" BROWN LEATHER TROLLEY TOOLBAG	£91.67



Code	Description	Sale Price
EDM743032	EDMA TOOL TOTE BAG (EDM743006 COMPATIBLE)	£146.18



OSCILOCUT

VIBRATING WIRE CUTTING TABLE FOR INSULATION MATERIALS

Clean cut of insulation materials such as rock wool, mineral polystyrene (E.P.S. and X.P.S.), phenolic foam, glass foam, rubber foam.

Battery operated for greater freedom of work. Delivered assembled, compact for easy storage and transport. CE certified.



SPECIAL ORDER



Code	Description	Sale Price
EDM368355	WITH ALUMINIUM AND WOOD CARRYING CASE	£1949.10

OSCILOCUT	
Max. cutting height	650mm
Max. cutting thickness	270mm
Motor	18 V, brushless = longer life
Lithium battery	18V - 2 Ah
Vibration frequency	1500 times/min

Accessories included:

- Motor
- Battery + battery charger
- 1 mounted cutting wire + 5 spare wires

Possible cutting shapes:

- Motor
- Battery + battery charger
- 1 mounted cutting wire + 5 spare wires

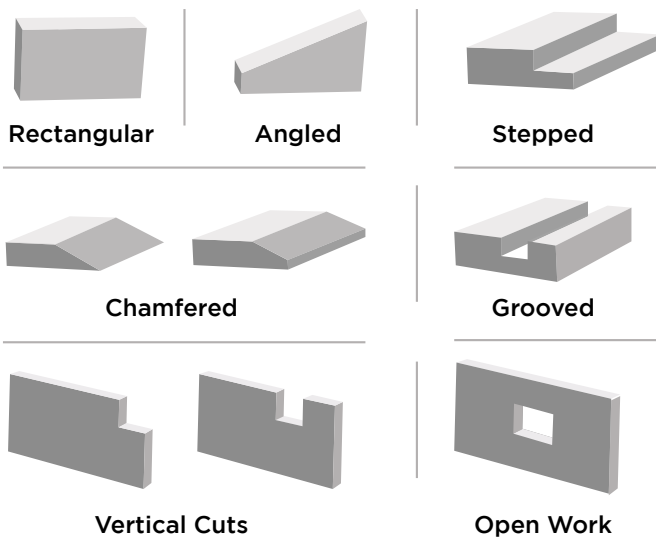

Code	Description	Sale Price
EDM536830	SPARE WIRE	£22.41
EDM536831	SPARE BATTERY (BATTERIES LITHIUM 18V - 2 AH.)	£65.04
EDM536832	BATTERY CHARGER	£39.95

COVERSMART

EXPANDABLE AND ADJUSTABLE SELF-ADHESIVE PROTECTIVE FILM

Waterproof. Resistant, 40 micron thickness. Easy installation even for one person. Protects from projections. Repositionable adhesive edges.

Can be used horizontally or vertically. 25 m roll



Code	Description	Sale Price
EDM179055	FILM 120cm EXTENDABLE WIDTH: FROM 45 TO 120cm	£37.07

MINERAL WOOL CUTTING TABLE

Special for rock wool panels.
Ideal to cut sheep wool, glass wool, cellulose wadding.
Allows accurate and clean cuts.
Made of aluminium.

SPECIFICATIONS

Max. cutting height	1200mm
Max. cutting thickness	260mm
Chamfered cut	up to 45°
Angle cut	up to 50°

Possible cutting shapes:



Rectangular



Angled



Chamfered

Accessories included:

- 300mm knife for insulation material
- Carrying case with wheels.



SPECIAL
ORDER

Code	Sale Price
EDM366955	POA

OSCILOCUT

RECIPROCATING ELECTRIC SAW FOR MINERAL INSULATION MATERIAL

Effortless.

accurate and clean cut.

Special for mineral insulation material such as rock wool.

14.4V - 1.5 Ah Li-ion battery and charger included.

Blade length: 300mm.

CE certified.



Code	Description	Sale Price
EDM366255	BOX SET AS ABOVE	£210.53

INSULATION CUTTER

2 different tooth shapes.

Holster included.

Symmetrical bi-material handle.

To cut without any effort rock wool, glass, wool, wood wool or hemp insulating panels, flax, cellulose wadding panels, etc... from 3 to 20cm thick.



Code	Size	Sale Price
0664	300mm	£30.32



FOLDABLE HOT WIRE CUTTING TABLE

SPECIAL ORDER

For styrofoam panel, especially for E.T.I.C.S. applications

Clean cut without polystyrene beads projection.

For expanded and extruded polystyrene (E.P.S. and X.P.S.).

Transformer: 42V / 240W / 230 V.

CE certified.



Code	Sale Price
EDM367155	£1231.80

SPECIFICATIONS	
Adjustable cutting height	from 810 to 1400mm
Max. depth	320mm

Possible cutting shapes:

- Motor
- Battery + battery charger
- 1 mounted cutting wire + 5 spare wires

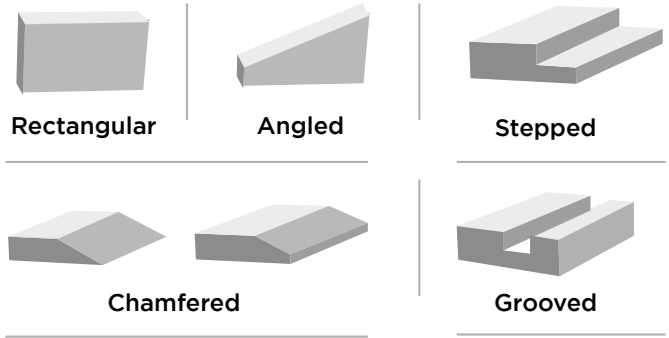

Accessories included:

- Motor
- Battery + battery charger
- 1 mounted cutting wire + 5 spare wires

CORDLESS HOT WIRE CUTTING BOW for styrofoam

Clean cut without polystyrene beads projection.

For expanded and extruded polystyrene (E.P.S. and X.P.S.).

Li-ion battery: 36V - 2 Ah.

CE certified.



Code	Sale Price
EDM267955	£346.05

SPECIFICATIONS	
Max. depth	330mm
Max. width	1370mm

Possible cutting shapes:

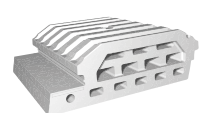
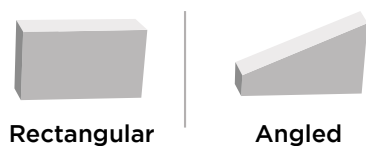

Ideal for cutting polystyrene slabs

Code	Description	Sale Price
EDM266855	SPARE WIRE - 1370mm	£13.08

HOT WIRE CUTTING TABLE

SPECIAL ORDER

For styrofoam panel, especially for E.T.I.C.S. applications

Clean cut without polystyrene beads projection.

For expanded and extruded polystyrene (E.P.S. and X.P.S.).

Transformer: 40V / 200W / 230 V.

CE certified.



Code	Sale Price
EDM266555	£1038.43

SPECIFICATIONS	
Max. cutting height	1200mm
Max. cutting thickness	260mm
Chamfered cut	up to 45°
Angle cut	up to 50°
Chamfered cut	up to 45°
Angle cut	up to 50°

Accessories included:

- Carrying case with wheels
- Scaffold hanging accessory
- Folding feet
- 2 cutting wires

Code	Description	Sale Price
EDM366855	SPARE WIRE - 1500mm	£13.09

Possible cutting shapes:



Rectangular



Angled

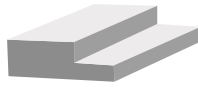

Stepped



Chamfered



Grooved



FOR STYROFOAM

HOT WIRE CORNER CUTTER

Cutting accessory for expanded polystyrene (E.P.S.) and extruded polystyrene (X.P.S.) to adapt on a hot wire cutting table. Allows multiple vertical cutting possibilities.



Code	Sale Price
EDM366655	£596.39

SPECIFICATIONS	
Max. cutting depth	500mm
Max. cutting thickness	310mm

Possible cutting shapes:

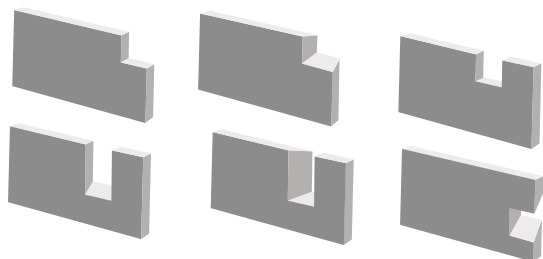

On the Table

2 possible positions depending on the height of the panels to be cut:

- High position: for panels up to 1000mm high
- Low position: for panels up to 600mm high

On the Table

3 possible positions depending on the height of the panels to be cut:

- High position: for panels up to 1015mm high
- Intermediate position: for panels up to 815mm high
- Low position: for panels up to 615mm high

Accessories included:

- Carrying case
- Li-ion battery and charger

Code	Description	Sale Price
EDM466855	SPARE WIRE - 610mm	£7.10

ABRASIVE SANDER SPECIAL FOR E.T.I.C.S.

Special for external insulation and cellular concrete.



Code	Size	Sale Price
EDM164955	380 x 160mm	£31.20

FOR STYROFOAM

HORIZONTAL HOT WIRE CUTTING TABLE

Clean cut without polystyrene beads projection.

For expanded and extruded polystyrene (E.P.S. and X.P.S.).

Transformer: 40V / 200W / 230V.

CE certified.

SPECIAL ORDER

NEW



Code	Sale Price
EDM260155	£536.38

SPECIFICATIONS

Max. depth	330mm
Max. width	1320mm
Angle cuts	from 0 to 90°
Chamfered cuts	from 90 to 15°

Possible cutting shapes:



Rectangular



Angled



Chamfered



Ideal for cutting polystyrene Slabs

Code	Description	Sale Price
EDM266855	SPARE WIRE - 1370mm	£13.08

EDMAFOAM

HOT KNIFE WITH AIR-COOLING SYSTEM

Faster clean and effortless cutting of styrofoam panels (E.P.S./X.P.S.).

No dust.

Air-cooling system enabling to be continuously operated.

Power: 320W.

CE certified.

Available in 2 versions:

Starting kit - Delivered in a plastic case including:

- 200mm blade
- Metallic brush
- Blade fixing key

Hot-knife + 3 blades set - Delivered in a plastic case including:

- 200mm blade
- 250mm blade
- 30mm groove cutter
- Metallic brush
- Blade fixing key

NEW



Code	Description	Sale Price
3675	HOT-KNIFE + 3 BLADES SET	£270.90

CUTTING GUIDE



Code	Description	Sale Price
4666	CUTTING GUIDE 210mm	£54.42



PROFILCUT® MEGA

GUILLOTINE FOR METAL PROFILES UP TO 100MM WIDE

Fast and clean cut without burrs.

Compact ergonomic design wire cutting table. Allows multiple vertical cutting possibilities. Time-saving, noise free, no sparks and no steel filings. Double non-sharp cutting blade to adapt to the width of the profile, from 40 to 100mm:

- Narrow blade: from 40 to 60mm + F530 profile
 - Wide blade: from 60 to 100mm
- Max. height of studs and tracks: 60mm.

Width of dies easily adjustable to fit the profile.

Also cuts corner angles. Integrated F530 die.

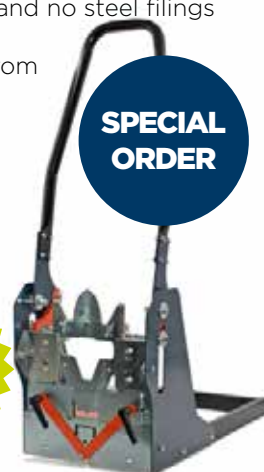

Code	Description	Sale Price
065855	GUILLOTINE FOR METAL PROFILES UP TO 100mm WIDE	£384.53

SUPER TACK-TICK

PULLING BAR FOR LAMINATE FLOORING INSTALLATION

Fast and effortless cutting.

No breathable dust. No noise. No sharpening required ever on blade.

With crowbar system.

Wide head for larger pulling surface.

Soft-touch material covers the base of the pulling bar to protect the laminate flooring.

For click-together laminate flooring.



Code	Sale Price
EDM087255	£28.10

STRATICUT® 230 LVT

LAMINATE AND VINYL FLOORING GUILLOTINE

Fast and effortless cutting.

No breathable dust. No noise. No sharpening required ever on blade.



Removable stoppers to make angle cuts, cuts in length and wider than 230mm planks.

Max. width with stoppers: 230mm overall.

Cutting die with 2 positions:

Position 1 (narrow die): to cut LVT (Luxury Vinyl Tile), HD vinyl and PVC floorings up to 12mm thick.

Position 2 (wide die): to cut laminate floorings up to 12mm thick.

Code	Sale Price
EDM089355	£117.17

CAMELEON 130

MITRE GUILLOTINE

130mm stainless steel blade.

Clean cut without any dust: wooden skirting boards, parquet flooring boards, panelling, battens, door frame mouldings, etc...

Perfect cut up to 28mm height and 130mm length with a range of angles from 45 to 90°.

Long handle for a fast and easy cut.

Ideal for cutting european woods (oak, beech...), american woods (cherry, southern yellow pine...), northern pine, PVC panelling, MDF panelling...



Code	Sale Price
EDM085055	£121.64

TRANSPLAC

HEAVY DUTY BOARD/DOOR LIFTER

Allows to carry boards and panels by one person.
New wide base for better stability.



Code	Sale Price
EDM064555	£23.08

DUOPLAC

BOARD/DOOR CARRIER HANDLES

Set of 2 pieces.
Steel handles to carry boards and panels by 2 persons.
Anti-slip grips.



Code	Sale Price
EDM064055	£22.85

FOOTPLAC

BOARD/DOOR LEVER WITH STEEL STIRRUP

To lift panels for an accurate positioning thanks to its rocker system.
Wide base for better balance.
Also ideal to unhinge doors.
Extra wide loop suitable for most safety footwear.



Code	Sale Price
EDM066055	£20.88

BLOCKPLAC

BOARD/DOOR HOLDER

Durable tool and easy to use

Allows to work alone thanks to the moveable block.
To lift and to hold the board or insulation panel in position while screwing it to the metal framing.
Offset handle.
Beveled edge to avoid damaging the plasterboard.

Code	Sale Price
EDM066555	£37.78



ROLL PLAC

MINI TROLLEY FOR BOARD/DOOR CARRYING

Effortless and autonomous plasterboard carrying.

Allows to carry up to 2 boards by one person.
2 built-in wheels for a fast, effortless movement in a comfortable position.
The wide base allows a better stability and prevents from damaging the plasterboard.
Steel frame = strong.
Bi-material handle for an optimum comfort.
Light and compact tool = very easy to store.



Code	Sale Price
EDM064655	£64.42

COVERSMART

EXPANDABLE AND ADJUSTABLE SELF-ADHESIVE PROTECTIVE FILM

Waterproof.
Resistant, 40 micron thickness.
Easy installation even for one person. Protects from projections.
Repositionable adhesive edges.

Can be used horizontally or vertically. 25m roll.



Code	Description	Sale Price
EDM179055	FILM 120cm EXTENDABLE WIDTH: FROM 45 TO 120cm	£37.07



EDMAPLAC CABLE

WINCH PANEL LIFTER

SPECIAL ORDER

360° free rotating head.

Lifts the plasterboard in horizontal and angled position.

Double cable for lifting and raising = safety.

Ball bearing pulleys for less effort.

Winch with bi-material handle.

Ergonomic tilting handle for easy loading of the plasterboard.

Smaller size, lighter, less bulky.

Easy door passage thanks to its folding side feet.

Equipped with 3 wheels, 2 with brake and 2 stabilization/transport wheels.

Delivered assembled except for the head.

CE certification.

Complies with European directive «MACHINERY» - 2006/42/CE.

Approved by the VERITAS conformity report #10673478-1.



SPECIFICATIONS

Max. load.	60kg
Max. board dimensions	1,20 x 3,60m
Min. board dimensions	0,15 x 0,60m
Max. height	3,50m
Min. height	1,60m
Board loading height	80cm
Dimensions in moving/storage position (length x width x depth)	131 x 85 x 25cm

Code	Description	Sale Price
EDM268655	WINCH PANEL LIFTER	£599.66



Ceiling installation



Sloping ceiling installation

MULTI PURPOSE TOOL

Stainless steel blade.

Bottle opener, nail puller and hammer, paint can opener, roller cleaner, scraper, joint knife, unmasking knife, filling knife/crack cleaner, rasp, cutter, 11mm (1/4") wrench, 14mm (3/8") wrench.

Bi-material handle with metal head.



Code	Description	Sale Price
EDM164355	MULTI PURPOSE TOOL	£8.92

HEAVY DUTY SCRAPER

Striking scraper, adjustable to a pole.

Stainless steel blade.

Bi-material handle with metal head.

Compatible with EDMA telescopic poles (not included).



Code	Description	Sale Price
EDM164555	HEAVY DUTY SCRAPER 8cm	£10.85

EDMAPLAC 450

RACK AND PINION PANEL LIFTER

SPECIAL ORDER

Power drill assistance available.

To lift plasterboard in every positions: horizontal (ceiling installation), angled (sloping ceiling installation) and vertical (wall installation).

Innovative braking system with 2 handles (main brake + safety brake) to lower the panel quickly under control.

Automatic operation thanks to power drill assistance.

Its rack and pinion system allows to lift plasterboards with less effort.

Ergonomic design with bi-material handle to tilt the top rack up to vertical position.

Tool carrier wooden board included.

Easy to pass through doorway thanks to its foldable feet.

3 wheels including 2 wheels with brake.

No noise while lifting on job sites.

CE certification.

Complies with European directive «MACHINERY» - 2006/42/CE. .

Approved by the VERITAS conformity report #628 8214-1.



MAX LOAD
80KG

MAX HEIGHT
4,50 M

MAX HEIGHT IN A VERTICAL POSITION
5,75 M

with 2,50m height panel



Assembly



Operation



Ceiling installation



Sloping ceiling installation



Wall installation

SPECIFICATIONS

Max. load.	80kg
Max. board dimensions	1,20 x 3,60m
Min. board dimensions	0,15 x 0,60m
Max. height with extension part	4,50m
Max. height without extension part	3,50m
Min. height	1,61m
Max. height for vertical lifting with 2,50 m height board	5,75m
Board loading height without extension part	84cm
Min. width in moving/storage position	63cm

Code	Description	Sale Price
EDM267355	RACK AND PINION PANEL LIFTER	£985.28

BUCKET SCOOP KNIFE

Allows to scrape/clean to the bottom of the bucket = avoids waste.

Curved stainless steel blade facilitates the taking of compound, in quantity.

Blade with a 13cm radius and 16,5cm width adapted to large buckets of compound.

Equipped with a hook to put the knife on the bucket.

Suitable for filling the EDMAPLIC or other drywall taper.

Bi-material handle with metal head.



Code	Description	Sale Price
EDM276755	STAINLESS STEEL BUCKET SCOOP KNIFE	£8.50

PAVING SUPPORTS WITH FIXED HEIGHT

eternoivica

Paver support with non-adjustable, fixed height.

ADVANTAGES:

- Quick and cheap solution.
- Three sizes (12mm, 15mm, 20mm).
- Can be placed on top or under the support.
- LGH2 and LGH3 Levelling discs - available in 2mm and 3mm.

EXTENDABLE PAVING SLAB LIFTER
280mm to 665mm
(tile not included)

2690
£56.67

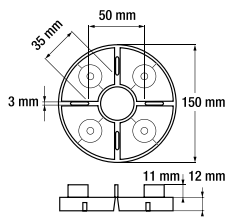

PS20

£0.70

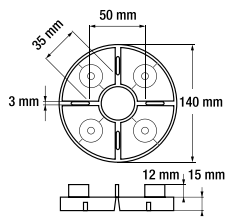

PS15

£0.70

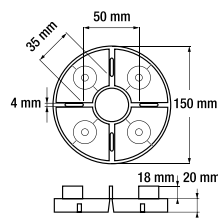

PS20 SPEC

£0.70

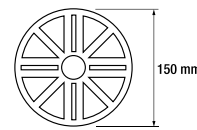

PS20LEV shim

£0.65

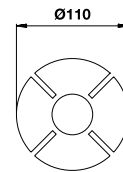

LGH2

£0.68

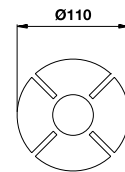

LGH3

£0.76

NEW RUBBER FIXED HEIGHT PAVING SUPPORT

SOUND SUPPRESSION PAD
210x210x6mm

£1.65 RUB6PAD

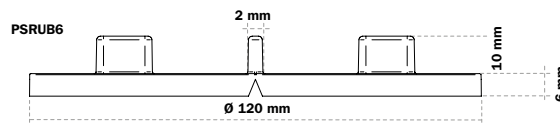

Code	Description	Sale Price
PSRUB6	RUBBER FIXED HEIGHT PAVING SUPPORT 6mm	£1.95



STAR.T PAVING SUPPORT

eternoivica

Adjustable support for exact levelling adjustments from 10mm - 30mm.

ADVANTAGES:

- **Enables exact level paving** - 10mm adjustable up to 30mm.
- **Strong composition** - formed from high quality moulded plastic for strength.
- **Highly flexible** - suitable for raising any type of ceramic, concrete or composite material floor of any size and weight.
- **Quick installation** - for a precise finish.
- **Easy stacking** - various depths for exact heights (10mm + 5mm).

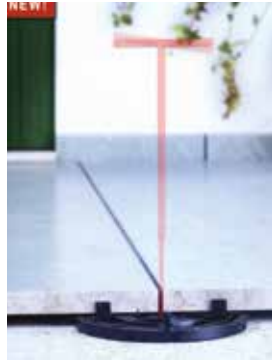

10 15
STAR.T

NM Star T Top

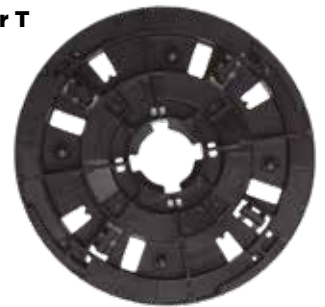

NM Star T Base



NM Star B Extension



Code	Description	Sale Price
NMSTART	ADJUSTABLE PAVING SUPPORT TOP & BASE 10-15mm	£1.90
NMSTARB	5mm EXTENSION FOR STAR SUPPORT	£1.53

NMSTART	NMSTARB	Achievable Height
1	-	10-15mm
1	1	15-20mm
1	2	20-25mm
1	3	25-30mm

SOUND SUPPRESSION PAD

210x210x6mm

£1.65

RUB6PAD



'SE' SELF-LEVELLING ADJUSTABLE WITH BI-MATERIAL HEAD

eternoivica

An adjustable self-levelling paving support.

ADVANTAGES:

- Integrated system that automatically accommodates roofing slopes to 5% variance.
- Adjustable heights from 28 - 550mm.
- Resistant to temperatures between -40°C to 120°C.
- Smooth support base of 205mm diameter.
- Easily removable tabs.
- Anti-noise and anti-slip bi-material head.
- Suitable for any self-supporting outdoor paving system.
- Fully recyclable.

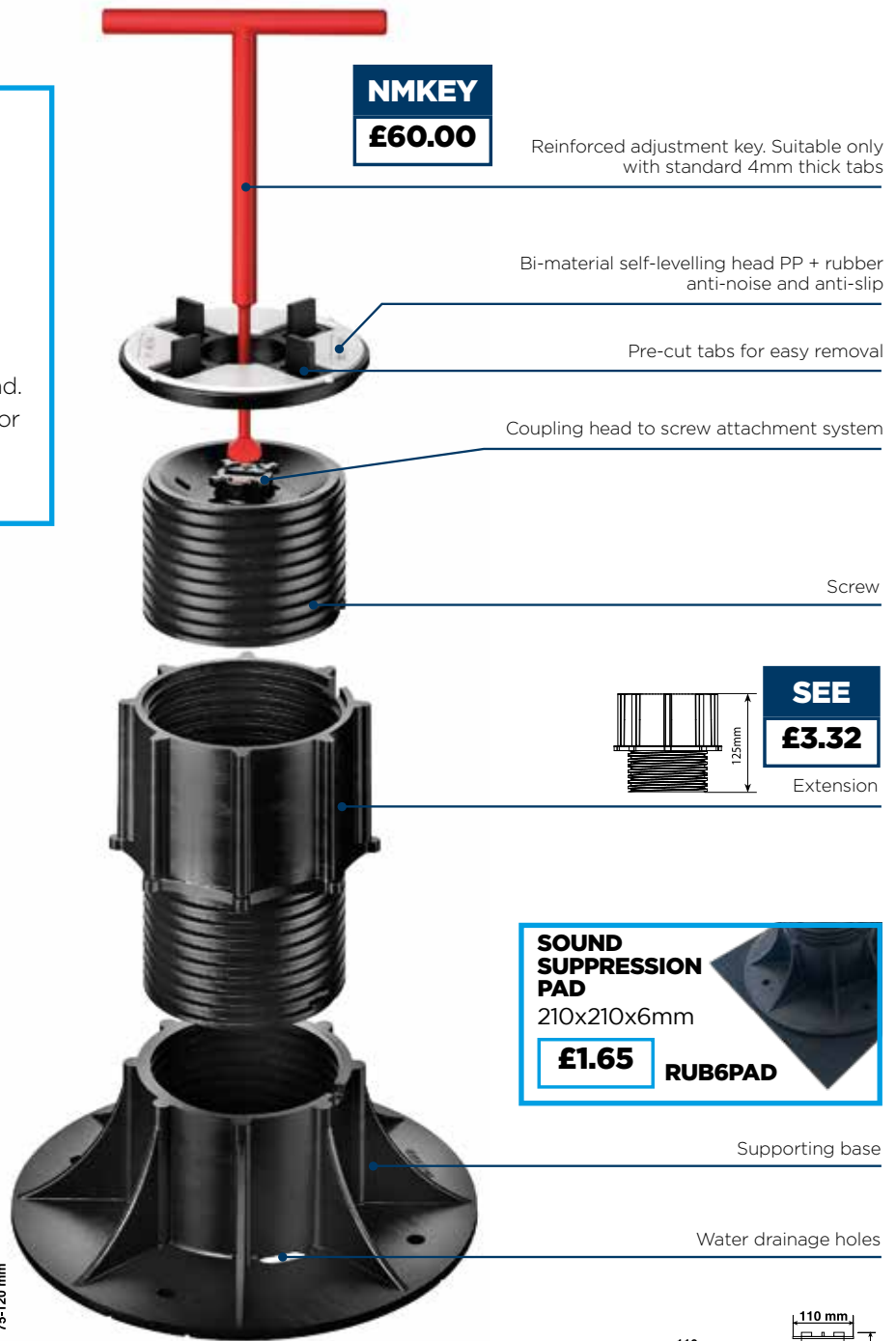

SE0 SE1 SE2
SE3 SE4 SE5
supplied 25
per box

SE 0	SE 1	SE 2	SE 3	SE 4	SE 5	SE 6	SE 7	SE 8	SE 9	SE 10	SE 11	SE 12	SE 13	SE 14
£5.67	£6.25	£6.67	£7.08	£7.92	£8.17	£10.40	£11.23	£11.48	£13.72	£14.55	£14.80	£17.03	£17.87	£18.12

'NM' FIXED HEAD ADJUSTABLE PAVING SUPPORT WITH BI-MATERIAL HEAD

eternoivica

An adjustable system enabling floor height adjustment after fitting.

Can be used in conjunction with any outdoor flooring.

ADVANTAGES:

- **Precision adjustment** from 25 to 935mm.
- **Easy adjustment** - refine the height once the floor is laid with exclusive adjustment key.
- **Noise-reducing** anti-slip rubber.
- **Smooth support** base of 320cm².
- **Long-lasting** - resistant to weathering, acids, UV rays and wear and tear.
- **Highly durable** - resistant to temperatures between -40° to 120°C.
- **Fully recyclable.**
- **Quick to fit** - easily removable tabs.

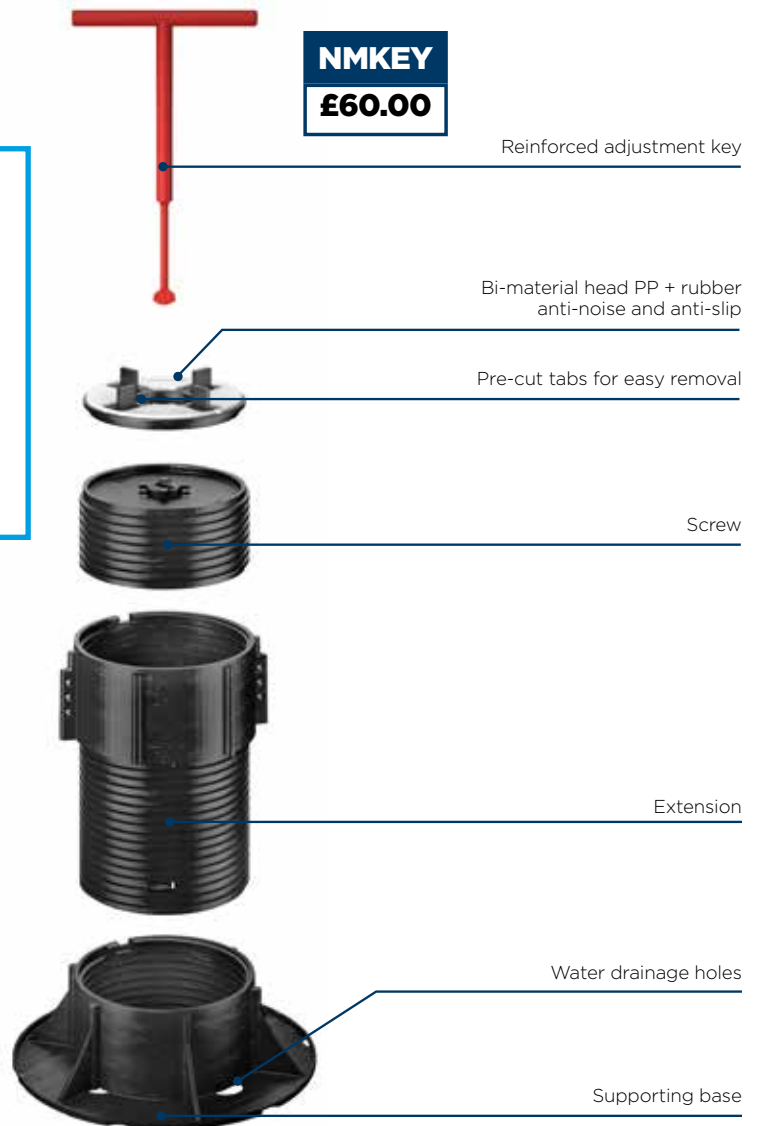
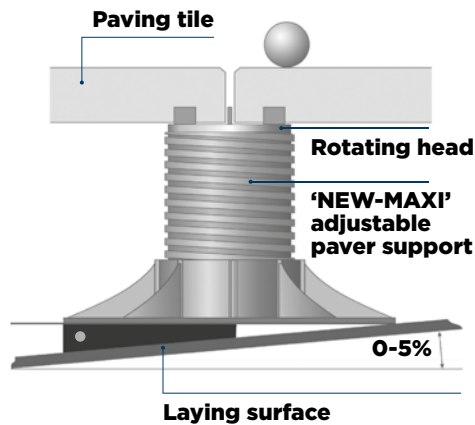

Code	Height Min-Max	Height +1 NME	Height +2 NME	Height +3 NME	Height +4 NME	Height +5 NME
NM 1	25-40	-	-	-	-	-
NM 2	40-70	-	-	-	-	-
NM 3	60-100	165-200	275-365	385-500	495-635	605-770
NM 4	90-160	195-280	305-415	415-550	525-685	635-820
NM 5	150-270	300-390	410-530	520-665	630-800	740-935

SOUND SUPPRESSION PAD
210x210x6mm
£1.65 RUB6PAD

NM1 NM2
NM3 NM4 NM5
supplied 20
per box

NM 1	NM 2	NM 3	NM 4	NM 5	NME	LGH2	LGH3
£4.55	£4.70	£5.20	£6.00	£6.83	£3.90	£0.68	£0.76

FIRE RETARDANT PEDESTALS

Class A1 Fire Rated.

Commercial use Paving Pedestals: Non-combustible, fully adjustable, Class A1 pedestal commercial grade high-rise balconies, terraces and flat roofs.

ADVANTAGES:

- **Non-combustible** to BS EN 13501-1 Fire classification of construction products & building elements.
- **Suitable for interior and exterior** applications and suspended paving.
- **A1 galvanised steel**. 100% metallic - no plastic or rubber components.
- Only product providing **both tilting/self-levelling** and fixed head options to ensure completely flat surface.
- **Ultimate flexibility** 360° tilting crisscross head for aluminium joist and decking options.
- **Precision heights** - from 28mm up to 458mm.

Key Features

- Easy-to-bend tabs
 - Fixed head with tabs for tiles
 - 180° and 360° tilting head with tabs for tiles
 - Fixed head for decking
 - 180° and 360° tilting head for decking
 - Fixed and 180° tilting crisscross head for aluminium joist
 - 180° tilting crisscross head for aluminium joist
- Complies fully with British Standard BS 8579**

SPECIAL ORDER

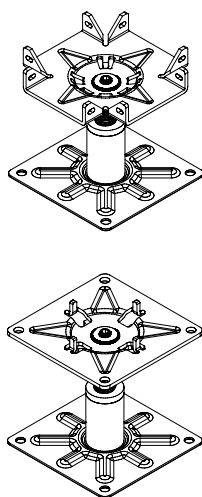
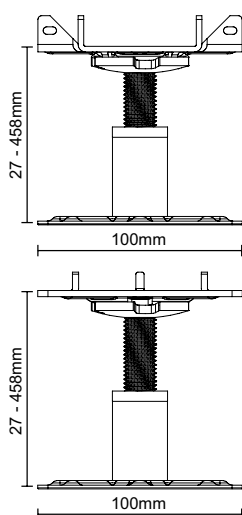

General support



Support for joists

Code	Description	Height Min-Max	Box Qty	Individual Sale Price
SMA1	SUPPORT	27-35mm	50	£11.15
SMAT1	SUPPORT HEAD FOR JOISTS	27-35mm	50	£11.65
SMA2	SUPPORT	34-46mm	50	£11.60
SMAT2	SUPPORT HEAD FOR JOISTS	34-46mm	50	£12.00
SMA3	SUPPORT	44-62mm	25	£13.15
SMAT3	SUPPORT HEAD FOR JOISTS	44-62mm	25	£13.65
SMA4	SUPPORT	61-97mm	25	£13.85
SMAT4	SUPPORT HEAD FOR JOISTS	61-97mm	25	£14.20
SMA5	SUPPORT	95-165mm	25	£15.20
SMAT5	SUPPORT HEAD FOR JOISTS	95-165mm	25	£15.75
SMA6	SUPPORT	163-300mm	20	£19.85
SMAT6	SUPPORT HEAD FOR JOISTS	163-300mm	20	£20.50
SMA7	SUPPORT	298-458mm	10	£22.95
SMAT7	SUPPORT HEAD FOR JOISTS	298-458mm	10	£23.55



UNIVERSAL EDGE CLIP

eternoivica

The perfect join, attractive and functional.

The universal edge clip for stability around a perimeter wall. The stainless steel clip stabilizes the pavers whether situated on whole or part (cut) pedestals. A polypropylene alternative is also available.

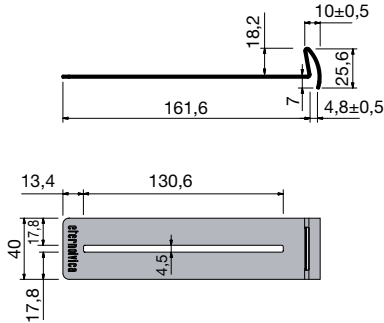

PSCLIPPP
£1.21



PSCLIP
£3.95



NMKEY
£60.00

Adjustable support installation

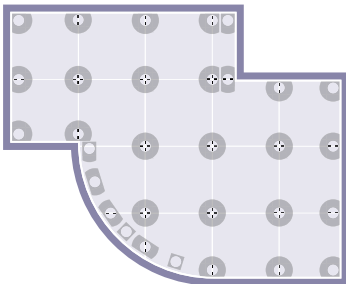

Fixed height support installation

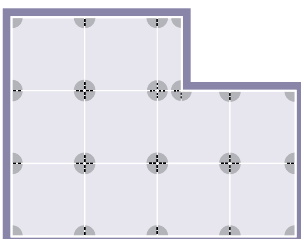

For pavers or tiles that are larger than 500x500mm, it is recommended that an extra paving support (with flat head) should be placed in the centre of the tile.

CONSUMPTION PER m ²	
Tile size	Supports per m ²
30 x 30cm	11,2
30 x 35cm	9,5
30 x 40cm	8,3
40 x 40cm	6,25
45 x 45cm	5
50 x 50cm	4
60 x 60cm	2,8

CLIP FOR VERTICAL CLOSURE

eternoivica

Innovative finishing to eliminate edging gaps and horizontal movement.

ADVANTAGES:

- **Wide ranges** - available in 20mm, 30mm or 40mm to suit tile widths.
- **Discrete** - concealed clip does not interfere with the finish.
- **Strong** - 100% stainless steel.
- **Flexible** - allows natural slab expansion movement.
- **Supporting** - wide wall support surface, spreads the slab pressure evenly.
- **Compatible** - works with the whole Pedestal range.

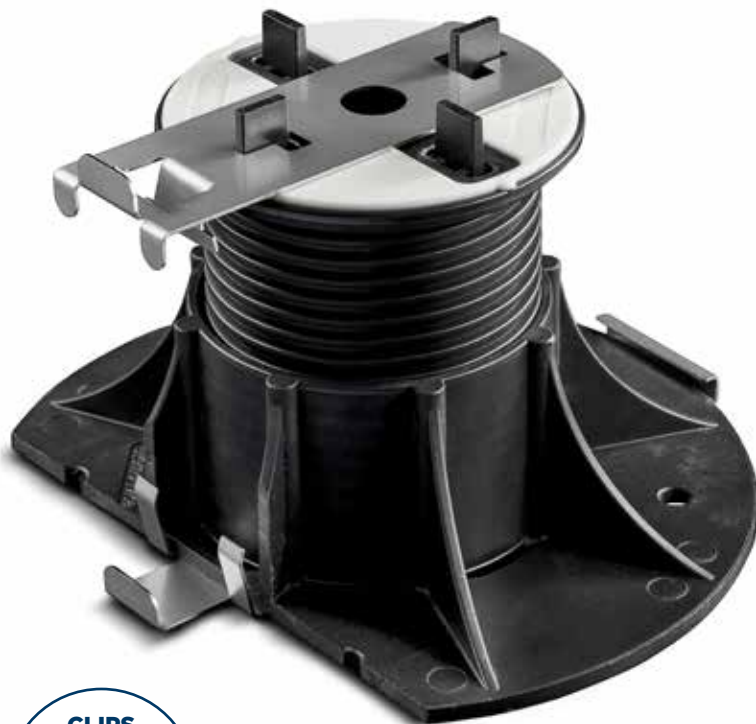

PSCLIPUV £9.98

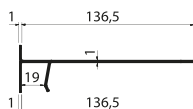

PSCLIPLC £8.50



CLIPS FOR 30MM AND 40MM TILES ARE AVAILABLE TO ORDER



'DS' DECKING SUPPORTS

eternoivica

The universal head is designed for all fastening needs and joist types. The slots on the head enable coupling of the joists from 18mm high.

The universal head is designed to accommodate and permit the fastening of all types of existing joists on the market. The slots on the head enable coupling of the joists from 18mm high.



NME **£3.90**

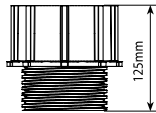

DS1 DS2
DS3 DS4 DS5
supplied
20 per box

Code	Size	Sale Price	Height Min-Max	Height +1 NME	Height +2 NME	Height +3 NME	Height +4 NME	Height +5 NME
DS1	25-40mm	£4.55	25-40	-	-	-	-	-
DS2	40-70mm	£4.70	40-70	-	-	-	-	-
DS3	60-100mm	£5.20	60-100	165-200	275-365	385-500	495-635	605-770
DS4	90-160mm	£6.00	90-160	195-280	305-415	415-550	525-685	635-820
DS5	150-270mm	£6.70	150-270	300-390	410-530	520-665	630-800	740-935

SOUND SUPPRESSION PAD
210x210x6mm

£1.65 RUB6PAD

RECYCLED RUBBER GRANULAR PROMENADE TILES

SPECIFICATION

Granular rubber tiles designed for installation on roof terrace, balconys, patios and walkways, they are free draining and manufactured to exacting standards using top quality SBR granular rubber combined with polymer binders to provide an attractive anti slip protective surface.

MAINTENANCE

All tiles should be cleaned on a regular basis. All tiles contain Carbon Black which may leach and rise to the tile surface and over time fading the green tiles.



Code	Description	Sale Price
GRANBLK	FLEXIBLE RUBBER TILE - BLACK 1000x1000x25mm	£59.99 Each
Weight	Fixing	Flammability
17.25kg m ²	Bonded to substrate using 5mm expansion spacing	Conforms to BS 7188:1998



Code	Description	Sale Price
MPURE	PU TILE ADHESIVE	£6.10
GRANSPACER	TILE SPACER - 5mm	£0.15



CMS

TOOLS LTD

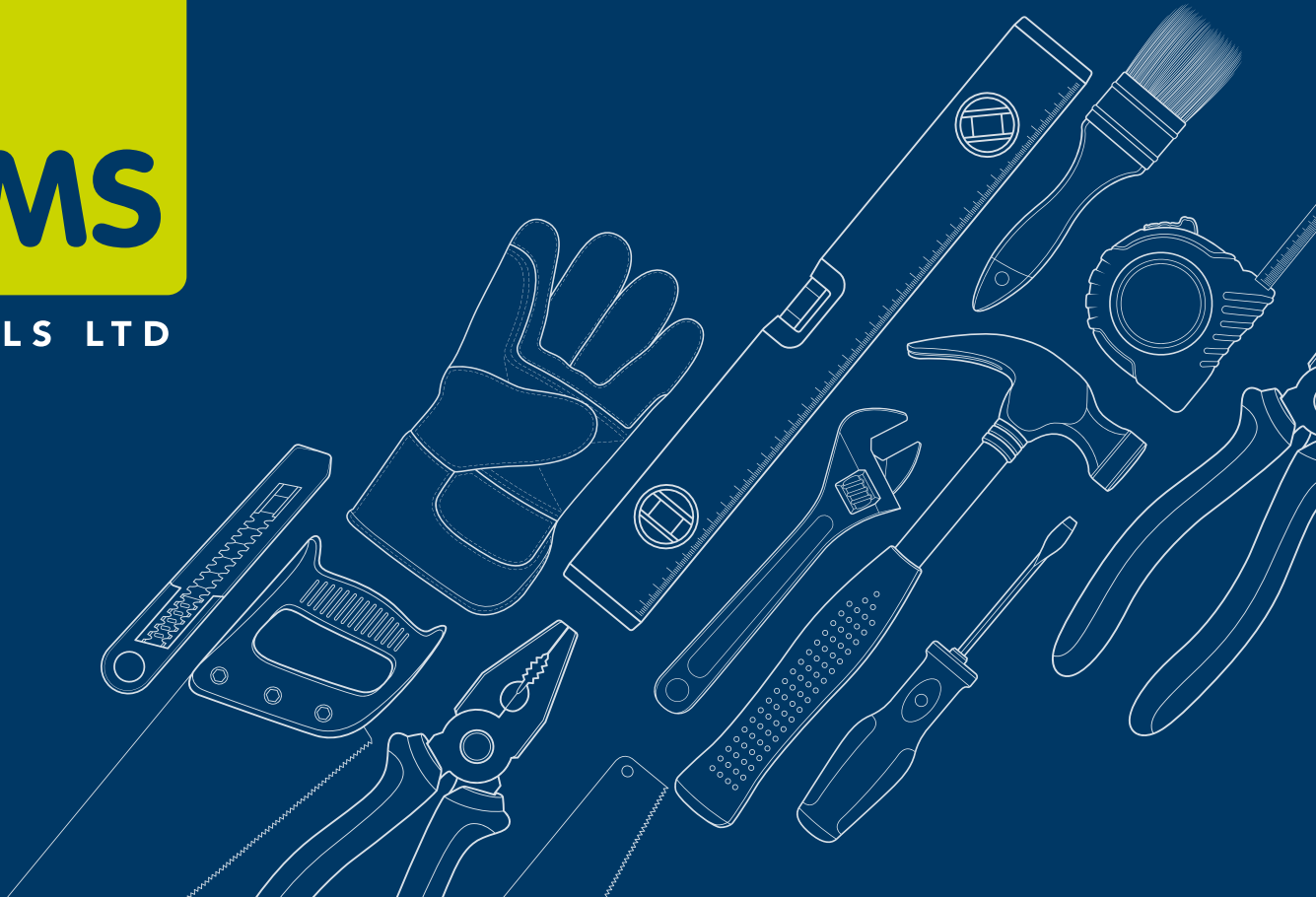

**CMS TOOLS Limited, Don Pedro Close,
Normanton Industrial Estate, Normanton,
West Yorkshire WF6 1TD**

**ORDER LINE:
01924 895999**

**EMAIL:
info@cmstools.co.uk**

**FAX:
01924 896999**

**WEBSITE:
www.cmstools.co.uk**

**PEDESTALS & PAVING SUPPORTS:
www.pavingsupports.co.uk**



eternoivica

GRÜN

