



THE BRICK PRODUCT GUIDE

WE ARE
Bricks and more.

IMAGE: LONG FORMAT NATURAL BLUE RIVEN,
APARTMENTS, UPTON, CHESTER, CHESHIRE

Click the blocks below to jump to relevant page.



WE ARE

at the heart of building.

We offer a diverse range of building products, solutions and expert technical and design services that enable our customers to create inspirational spaces and places.

Everything we do revolves around our valued customers and we continuously strive to exceed their expectations. We pride ourselves on leading for new, innovative and sustainable products and solutions, both for today and for a new era of building.

WE ARE at the heart of building. WE ARE Istock.



Staircases and Lift Shafts

Facade Systems

Roofing

Flooring and Lintels

Fencing and Landscaping

Retaining Walls

Rail and Infrastructure

Design and Technical Services

We are committed to providing the best possible design and technical support to our customers. From expert advice to a sector-leading training and CPD provision, Istock's range of design and technical services are especially configured to give architects and specifiers the access to the support they need at every stage on their project journey – from concept to build.

IMAGE: BERKSHIRE ORANGE BRICKS,
WELLINGTON HOUSE, LONDON

IBSTOCK – PROUD TO BE THE NUMBER 1 BRICK MAKER IN THE UK

Ibstock is the largest brick manufacturer in the UK.

With over **200 years of brickmaking heritage** and the widest range of UK produced bricks available, we are able to offer the ideal product whatever the project. This, coupled with our unparalleled technical and design expertise, is why we are the **UK's number 1 brick maker**.



OVER 200 YEARS OF
BRICKMAKING HERITAGE
AND EXPERTISE



PROUD TO BE THE
NO. 1 BRICK MAKER IN
THE UNITED KINGDOM

KNOW YOUR BRICKS: **CLAY VS CONCRETE**

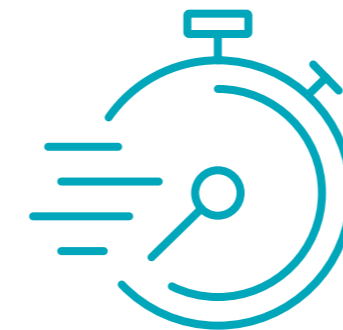

Building with clay brick is 30% quicker

than concrete brick – equivalent
to a **saving of 8 working days**
for an average house.



Comparable full lifecycle CO² emissions

when a like for like analysis
compares **concrete and clay brick**
over a buildings lifetime.



IMAGE: IVANHOE CREAM BRICKS,
BOW RIVER VILLAGE, LONDON

GET TO KNOW YOUR BRICKS: WHY CLAY?

The UK as we know it today was built on brick. The literal foundation of our contemporary built environment, and the material which overwhelmingly comprises not just our homes and places of work, but also some of our most iconic landmarks.

It is the simplicity of brick that is perhaps the key to its endurance. There is a latent power in a product made from **earth, fire and water**; a product that is at once ancient and yet, increasingly, applied in new and exciting ways. It is also that durability that has seen brick become the building material of choice for British architects, and why the UK manufactured **1.9 billion bricks in 2019 alone**.

The figures on this page are taken from the Brick Development Association's 'Know Your Bricks' findings and infographic. For more information, [click here](#).

DURABLE

150 years life expectancy



FLEXIBLE

12 metre movement joint spacing for clay brick façades



DIVERSE

1000's of colours, textures and finishes available



LOCALLY MADE

68 miles average delivery distance



FAMILIAR

77% of new homes are built with Clay Bricks



RELIABLE

150,000 UK homes built with Clay brick in 2019



THE FACE OF THE UK

1.9 billion clay bricks manufactured in the UK in 2019

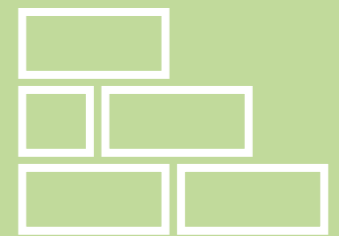

IMAGE: SOUTHWARK MULTI STOCK,
PRIVATE HOUSING, HAMPSHIRE

BRICKMAKERS QUALITY CHARTER: TOP MARKS FOR IBSTOCK BRICK

We are incredibly proud to be a founding signatory of the BDA's Brickmakers Quality Charter.

It was with significant honour that we became one of the first brickmakers nationwide to achieve accreditation from this new charter, securing a **three-star rating** – the highest possible level of accreditation.

This certification bears testament to the robustness of both our supply chain and manufacturing processes, and demonstrates our continued commitment to ensuring the ethical manufacture of best quality bricks.

ACHIEVING THE HIGHEST LEVEL OF ACCREDITATION

Securing this accreditation was a uniquely involved process, in which we had to demonstrate our adherence with eight globally recognised Critical Assessment Points (CAP). These included the Responsible Sourcing Systems (BES 6001), Health & Safety Management Systems (ISO 45001) and the Anti-Modern Slavery Policy and Procedures, in line with existing national standards.



BES 6001

Responsible Sourcing Systems



ISO 45001

Health & Safety Management Systems



Anti-Slavery Policy



SECURING CHARTER ACCREDITATION IS AN IMPORTANT STEP FORWARD FOR OUR BUSINESS, AND SIGNALS OUR ONGOING COMMITMENT TO LEADING THE WAY ON QUALITY.

IBSTOCK'S SUSTAINABILITY ACHIEVEMENTS

Sustainability is a key strategic driver for Istock plc.

Our products have been central to the creation of new homes and workspaces enabling people to live in comfort and safety for almost **200 years**. We are proud of our role in shaping the look and feel of our built environment. We know that we are facing some big challenges not least the loss of natural habitats and the impacts of climate change.

Our ambition is to be the **most sustainable manufacturer** of clay and concrete building products in the UK. As a market leader it is our responsibility to be at the **forefront** in this vital area, a responsibility we take very seriously.

ibstockplc.co.uk/sustainability

IBSTOCK IS 'A GOOD EMPLOYER TO WORK FOR' BASED ON A RECENT EMPLOYEE SURVEY

ONE TO WATCH
GOOD TO WORK FOR
2021
ceribonus

IBSTOCK CONTINUED TO SUPPORT ITS CHARITY PARTNER SHELTER THROUGHOUT 2021

SHELTER

WE ONLY USE
100%
GREEN ELECTRICITY

WE REMOVED **200 TONNES** OF PLASTIC PACKAGING IN 2021

WE DEVELOPED A NEW **ECOHABITAT RANGE** SUPPORTING OUR CUSTOMERS TO BUILD **BIODIVERSITY** INTO THEIR PROJECTS

GROWTH TO **13%** OF OUR SALES TURNOVER FROM PRODUCTS THAT ARE NEW AND SUSTAINABLE, ON TRACK FOR **OUR TARGET OF 20%**

IBSTOCK'S SUSTAINABILITY COMMITMENTS



**OUR OPERATIONS
WILL BE NET ZERO
CARBON BY 2040.**



**ATLAS.
WORLD'S
FIRST NET
ZERO BRICK
FACTORY**

COMING IN 2023

**LAUNCH OF
IBSTOCK FUTURES
WITH FOCUS ON
SUSTAINABILITY AND
INDUSTRIALISATION.**

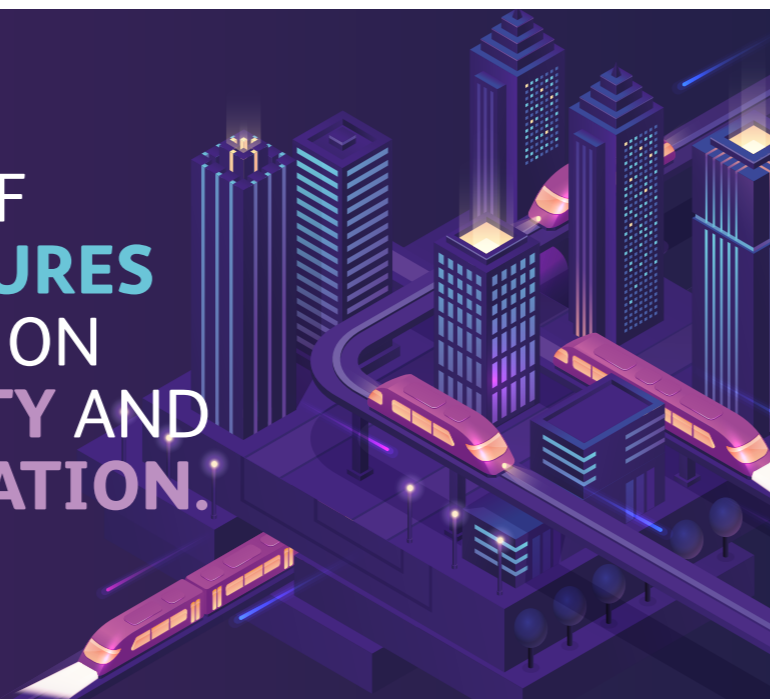

**CONSTRUCTION OF THE
UK'S FIRST AUTOMATED
BRICK SLIP SYSTEMS
FACTORY, NOSTELL, IS
UNDERWAY AND WILL
PRODUCE NET ZERO
CARBON PRODUCTS.**



IMAGE: KILCREGGAN MULTI WIRECUT,
GORBALS GLASGOW

YOUR COMPREHENSIVE GUIDE TO THE UK'S LARGEST BRICK RANGE

1

Brick texture



Close up shots of each of our bricks to demonstrate the texture of the product.

2

Special shapes



How these products can be used to get the details perfect.

3

Brick matching



A guide to brick matching, helping you to choose the correct product for your project.

4

Handy hints



Our Get it Right section, with reminders about how to get those most important tasks right.

www.ibstockbrick.co.uk

IMAGE: STAFFORDSHIRE SLATE BLUE
SMOOTH, APARTMENTS, LONDON

HOW TO CHOOSE THE RIGHT BRICK FOR YOU: USING THE BRICK SELECTOR

We have arranged our bricks throughout this brick selector in order of colour, type of manufacture and texture.

1

Brick type

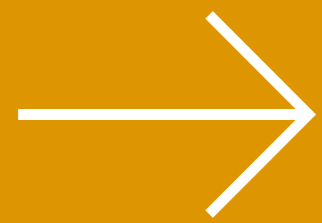

Produced using a variety of manufacturing techniques to suit any project.

2

Brick size

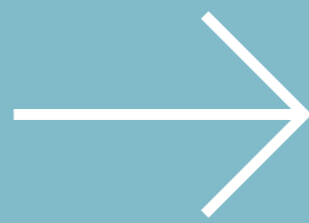

Where bricks are available in different sizes we have indicated this by a simple table.

3

Colour & texture

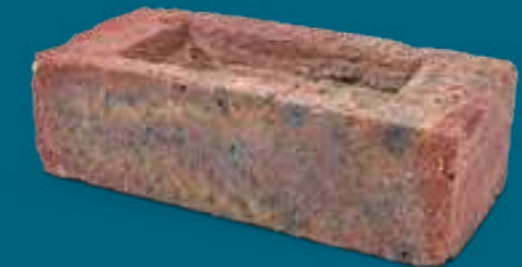
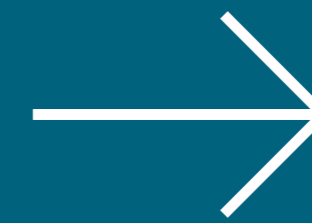

Look closely at the brick you are matching to establish the type, colour and texture.

HOW TO CHOOSE THE RIGHT BRICK FOR YOU:

BRICK TYPES

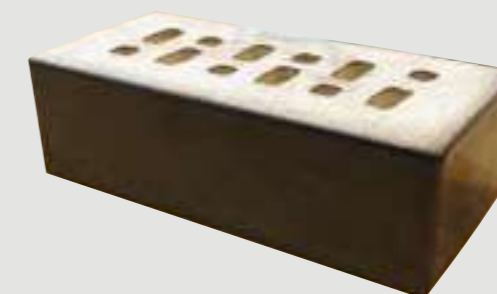
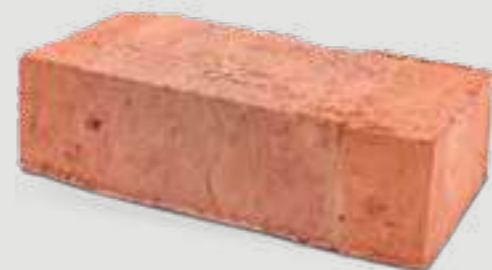

Wirecut

Defined edges are formed within the manufacturing process although a softer edge can be achieved by rumbling; perforations through the body of the brick easily identify if the brick is wirecut. Can also be a solid brick.



Waterstruck

Often a solid brick, although a few products are made frogged. Commonly a lip is evident at the bottom of the face.



Stock

Commonly has soft edges, **ALWAYS a frogged body.**
(Indent in the top of the brick).



Handmade

Commonly has soft edges, **OFTEN a frogged body.**
(Indent in the top of the brick).



Glazed

Smooth textured with a gloss face and header, glazed bricks are typically wirecut and come in a variety of high impact colours.



Long format

Long format bricks come in a variety of lengths, colours and textures – the majority of our long format bricks are solid or wirecut.

IMAGE: NEUXS SOFFIT AND LINTEL SYSTEMS AND A MIX OF GLAZED BRICKS

HOW TO CHOOSE THE RIGHT BRICK FOR YOU: BRICK SIZES

CHOOSING THE RIGHT BRICK

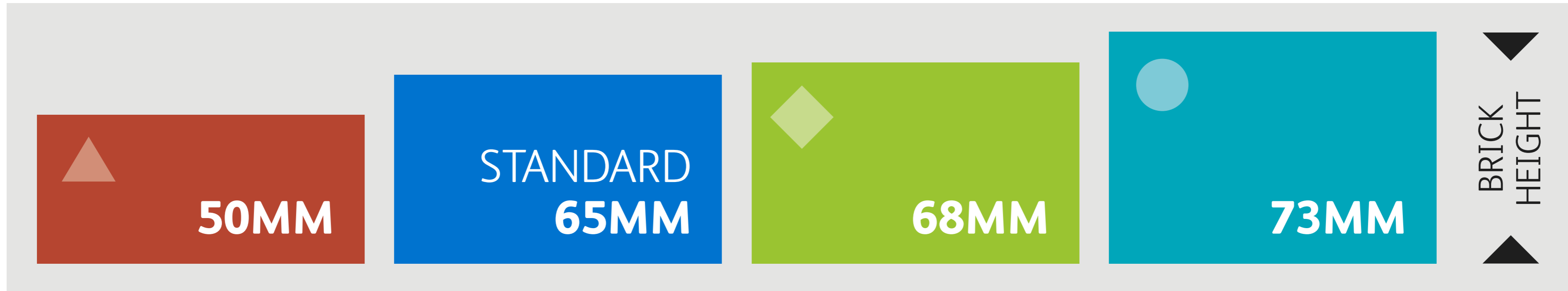

Bricks are made in a number of sizes, the **standard being 215mm x 102mm x 65mm**. Matching the height to existing brickwork creates a more continuous appearance. A selection of products are also available in **50mm, 68mm** and **73mm**. We have indicated which of our bricks come in alternative sizes throughout the brochure using the symbols shown above. We also have a range of **longer format bricks** from **240mm to 490mm long**.

IMAGE: NEW CHAILEY RUSTIC STOCK,
LONG FARM, REYDON

HOW TO CHOOSE THE RIGHT BRICK FOR YOU: COLOUR AND TEXTURE

Colours

There are eight basic body colours to choose from. We then add variations of darker and lighter shades to create a wider choice.

NOTE: Bricks are made from natural materials so colours will vary slightly from batch to batch.

1



Textures

Bricks are available in several textures. Identifying the texture of the brickwork you are matching to will help to narrow down your choices.

2



IMAGE: IVANHOE OLDE VILLAGE,
ALDERWOOD, PRESTBURY

COMMONLY USED JOINT PROFILES

Choosing the correct mortar joint profile

One of the factors that influence the long term performance of brickwork is the correct mortar joint profile for efficient shedding of rainwater.

MORTAR COLOURS

Consideration should be given to mortar colour, as this will influence the appearance of the completed brickwork. The mortar colour will help new brickwork blend in to existing brickwork, as the colour of the bricks can appear to change depending upon mortar colour. The bricks shown here are all the same colour, **only the mortar colour is different.**

IMAGE: MIX OF BIRTLEY OLDE ENGLISH BUFF & WHITE ENGOBE, STUDENT ACCOMMODATION, MAYNOOTH UNIVERSITY, IRELAND

BRICKWORK BONDING PATTERNS

Bonding in brickwork refers to the pattern in which they are laid. They usually overlap between courses in order to distribute load and provide stability. Bonding can also be used for decorative purposes.

1

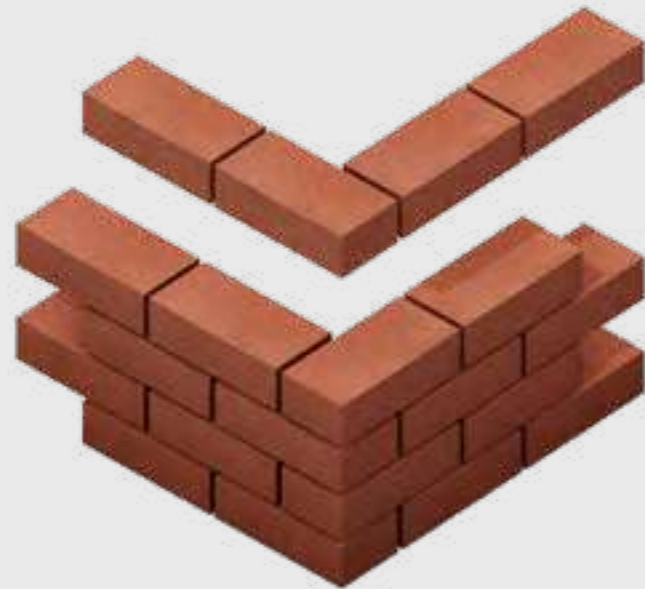

Stretcher bond

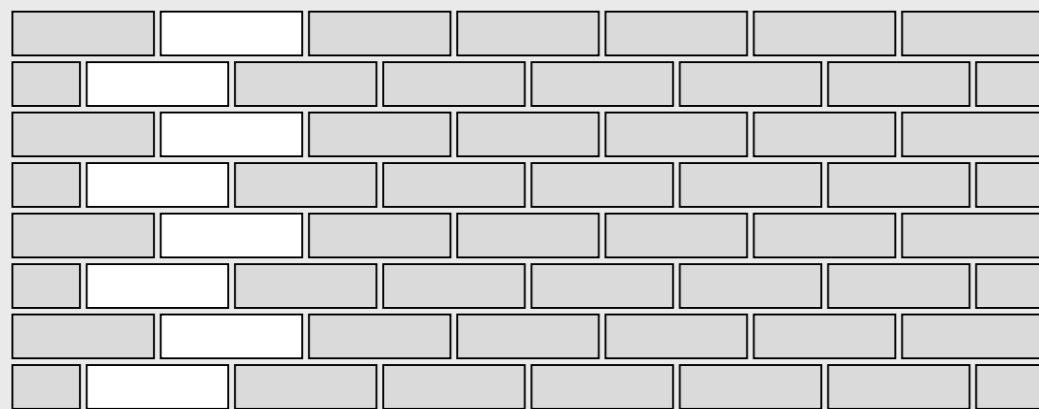

2



English bond

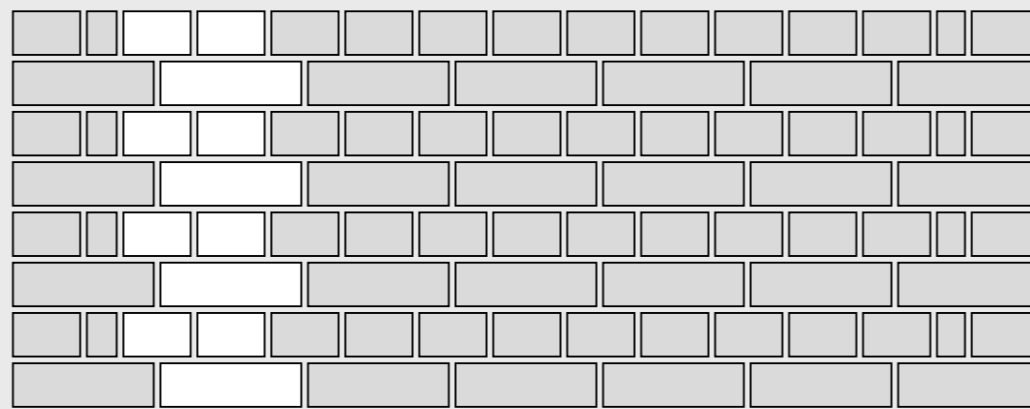

3

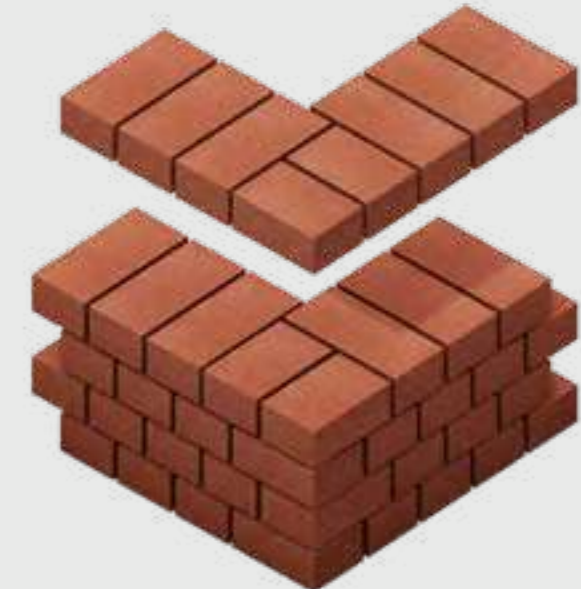

Header bond

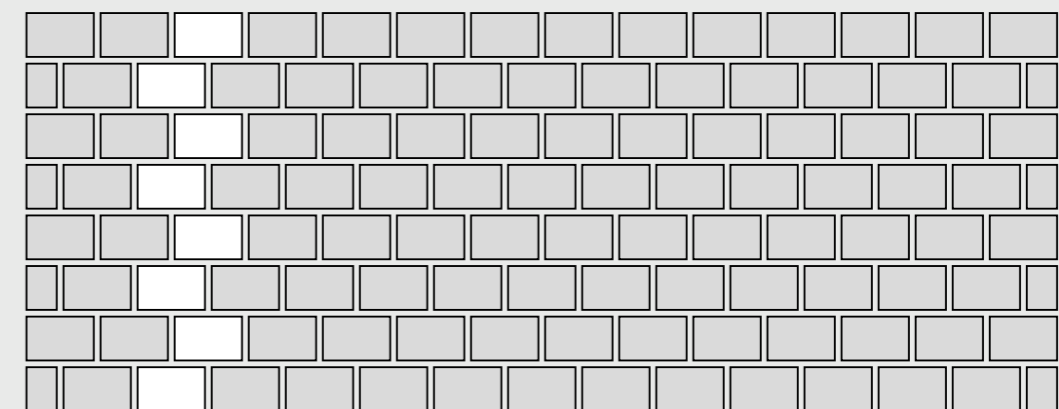

IMAGE: MIX OF BIRTLEY OLDE ENGLISH BUFF & WHITE ENGOBE, STUDENT ACCOMMODATION, MAYNOOTH UNIVERSITY, IRELAND

BRICKWORK BONDING PATTERNS

Bonding in brickwork refers to the pattern in which they are laid. They usually overlap between courses in order to distribute load and provide stability. Bonding can also be used for decorative purposes.

4



Flemish bond

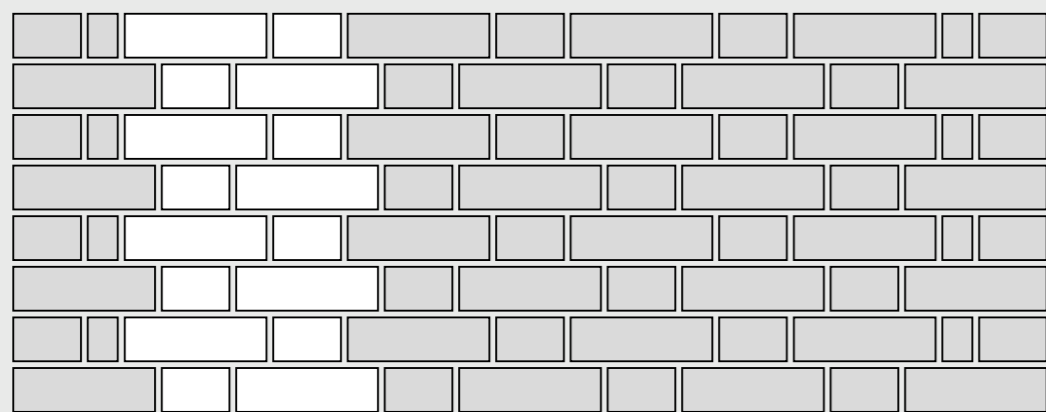

5



Flemish garden wall

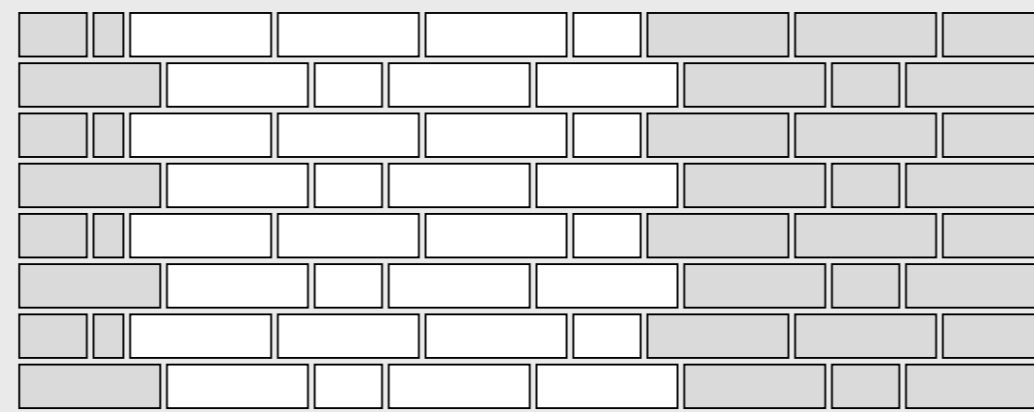

6



English garden wall

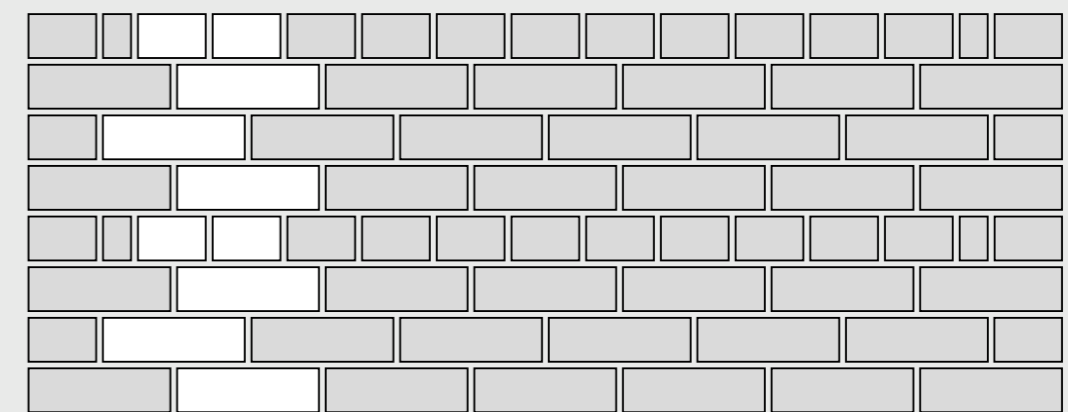

IMAGE: CHESTER RED BLEND,
OFFICES, SOVEREIGN STREET, LEEDS

GOOD PRACTICE AND SAFE STORAGE FOR YOUR IBSTOCK BRICKS

1 Brick storage and protection

Bricks should be inspected on delivery. They should be unloaded directly onto a hard standing that is:

- ✓ Firm and level
- ✓ Well drained
- ✓ Puddle free



IMPORTANT!
ALWAYS COVER
OPEN PACKS



2 Mix bricks from THREE different packs to achieve a consistent appearance

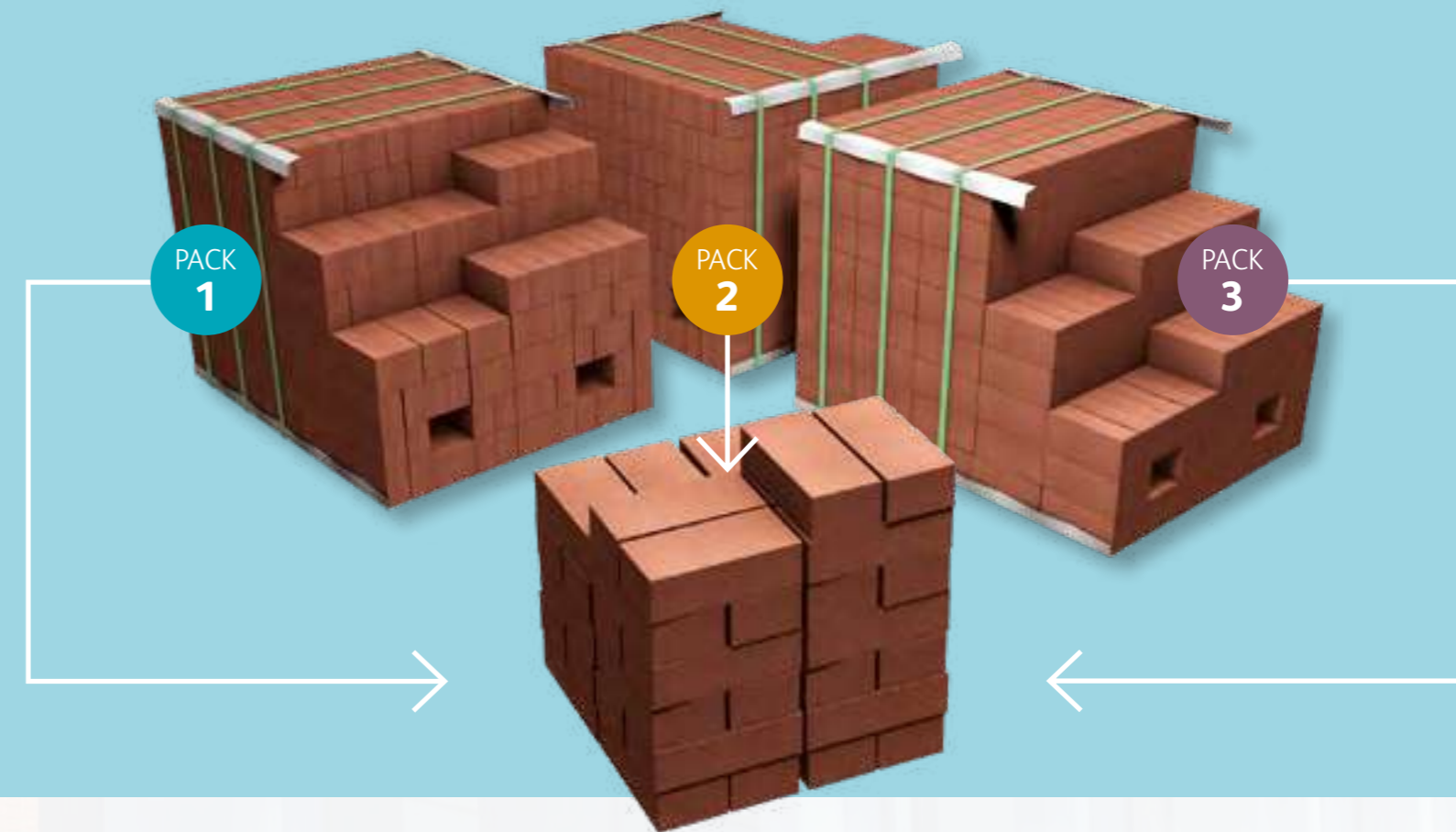

IMAGE: CHESTER RED BLEND,
OFFICES, SOVEREIGN STREET, LEEDS

GOOD PRACTICE AND SAFE STORAGE FOR YOUR IBSTOCK BRICKS

3

Protection of newly built brickwork

All walls must be covered when work stops. Rain on new work can cause:

- ✗ Colour change of mortar
- ✗ Lime stains
- ✗ Saturation
- ✗ Efflorescence

REMEMBER

- Cover your brickwork!
- In rain, snow and frost use a water resistant cover
- In dry weather, use hessian or a similar product



4

Design and technical advice

Design and technical teams offer advice on the performance and properties of all products within the Brick Selector including British Standards and Codes of Practice.

Our team of Design Advisors can offer creative and cost-effective solutions to any design project. Quality assured to ISO 9001, they can offer practical advice on a diverse range of issues including movement joints, brick and mortar specification through to architectural details involving special shapes.

FOR MORE INFORMATION AND ADVICE VISIT
www.ibstockbrick.co.uk/literature

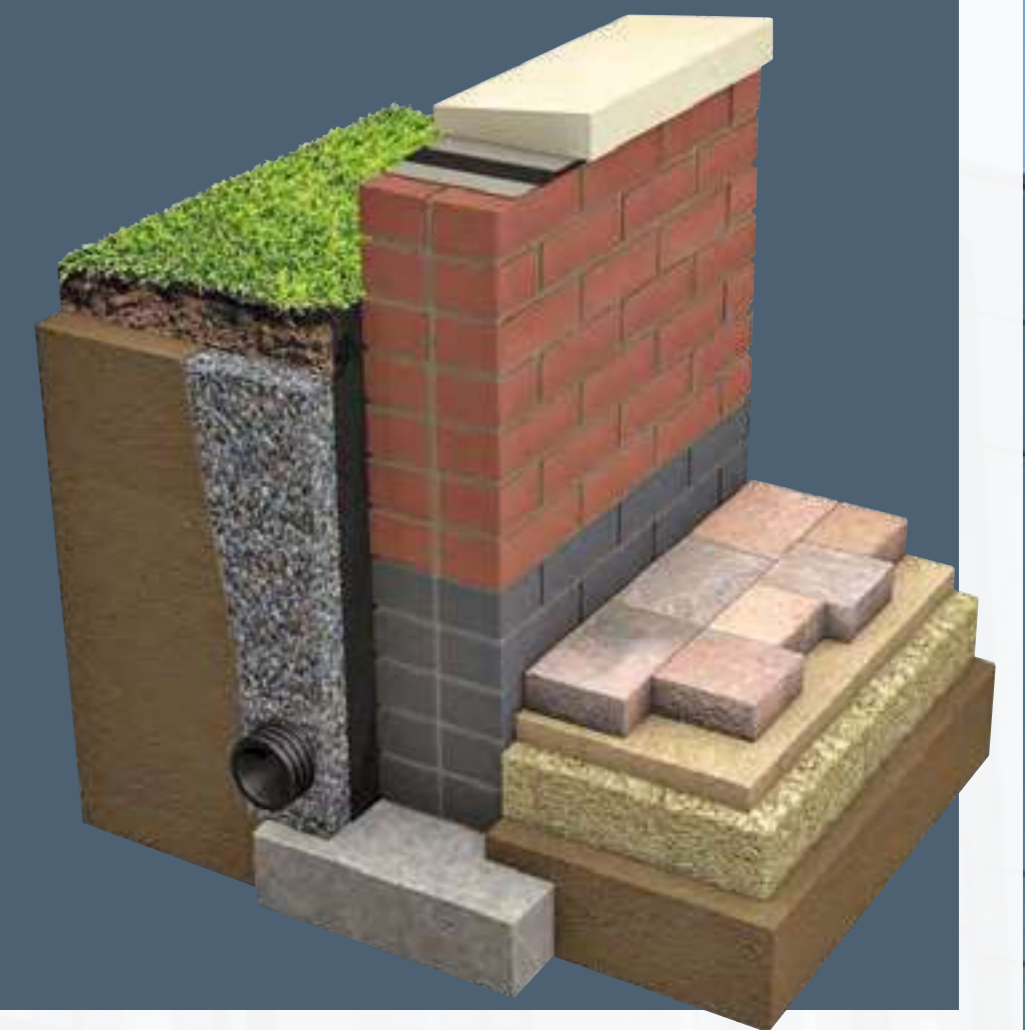

DESIGN AND TECHNICAL SERVICES

We are committed to providing the best possible design and technical support to our customers.

From expert advice to a sector-leading training and CPD provision, Istock's range of Design & Technical services have been especially configured to ensure architects and specifiers have access to the **support** they need at every stage of their project journey – from Concept to Build.

Our design and technical offering comprises a range of services designed to provide complete, **end-to-end** support throughout the project lifecycle.

ibstockbrick.co.uk/technical-services



MEET THE TEAM



CONCEPT TO BUILD CASE STUDIES

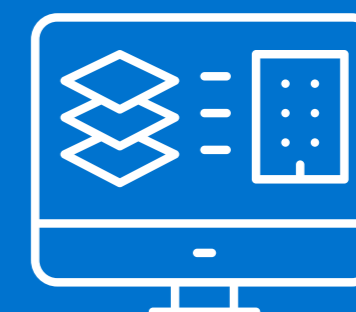

TECHNICAL INFORMATION



CPDS



BIM LIBRARY



BBA ACCREDITATION

IMAGE: KINGSTON HANDMADE RESTORATION RED,
HOUSING REFURBISHMENT, BUXMEAD, LONDON

RED BRICKS

RED BRICKS

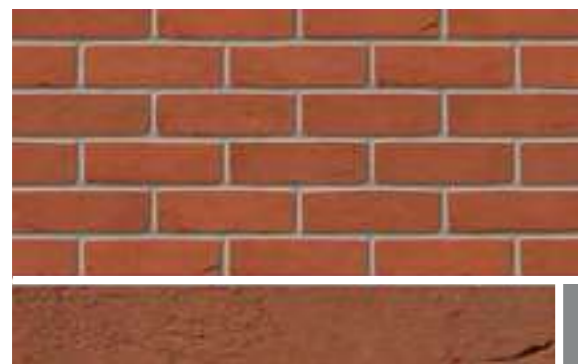

Kingston H/M Heather Red* Swanage 4355
HANDMADE

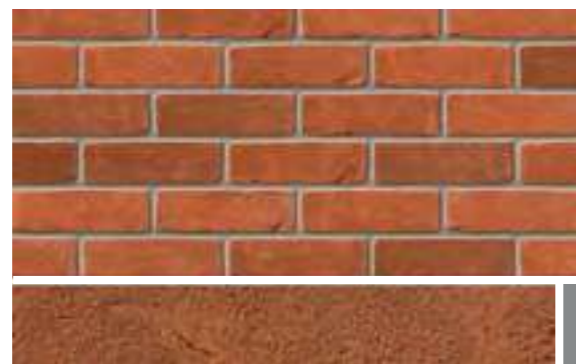

Swanage H/M Heather Red Swanage 4301
HANDMADE

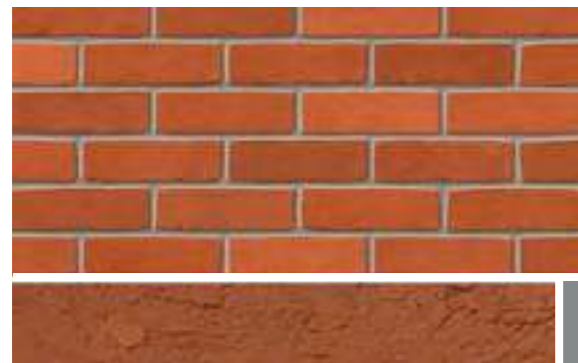

Kingston H/M Restoration Red* Swanage 4354
HANDMADE

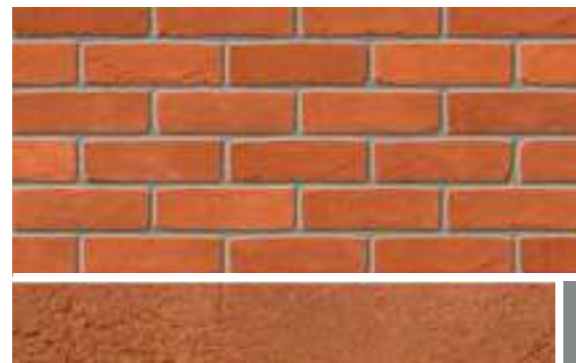

Swanage H/M Restoration Red Swanage 4312
HANDMADE

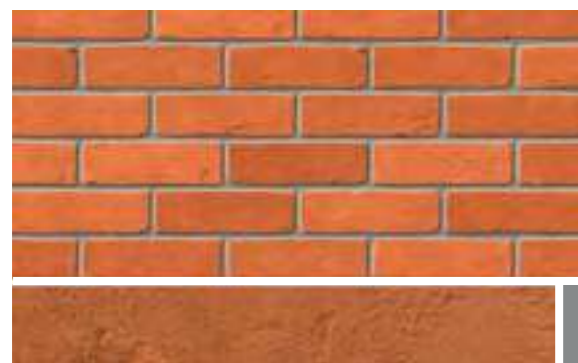

Kingston H/M Light Red* Swanage 4357
HANDMADE

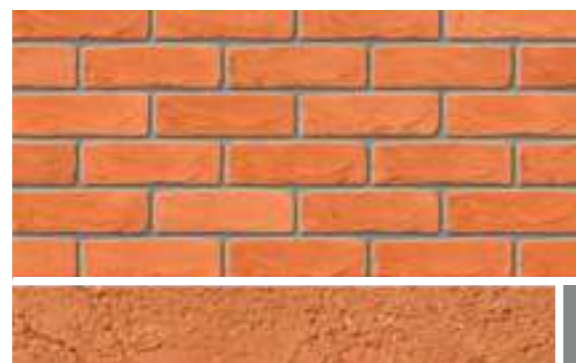

Swanage H/M Light Red Swanage 4302
HANDMADE



Northumbrian Cottage Birtley 2622
WATERSTRUCK

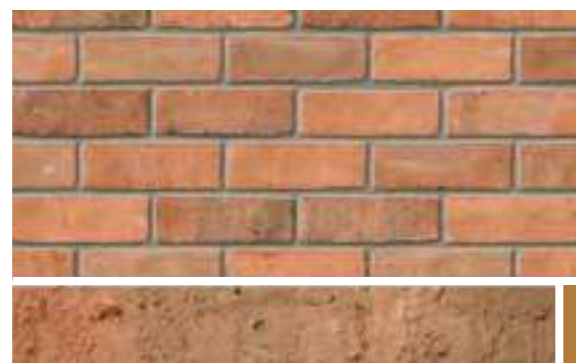

Commercial Red Birtley 2611
WATERSTRUCK



SWANAGE HANDMADE RESTORATION RED: COOMBE ABBEY HOTEL, COVENTRY



BRADGATE RED: MORE MUSIC EAST COURTYARD PROJECT

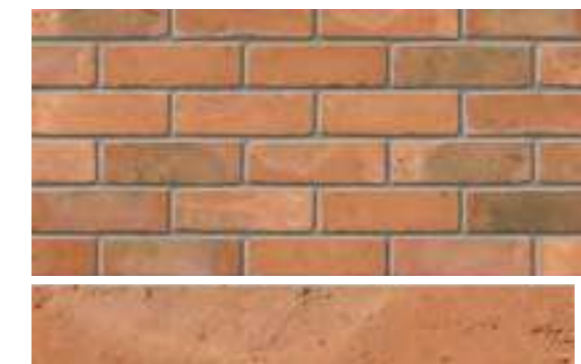

Otterburn Antique Birtley 2621
WATERSTRUCK



Warwickshire Olde English Birtley 2613
WATERSTRUCK

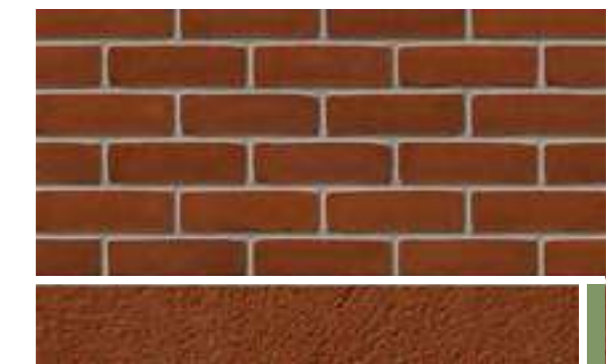

Parham Red Stock Laybrook 0708
STOCK

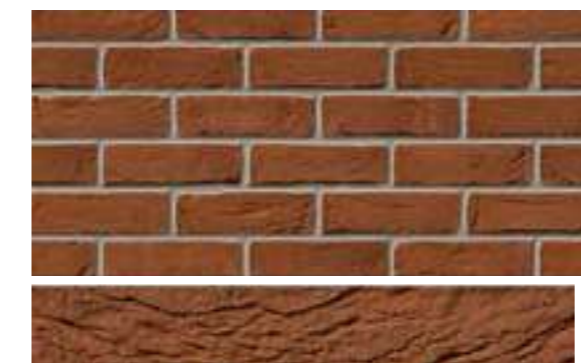

Bradgate Red Leicester 0020
STOCK

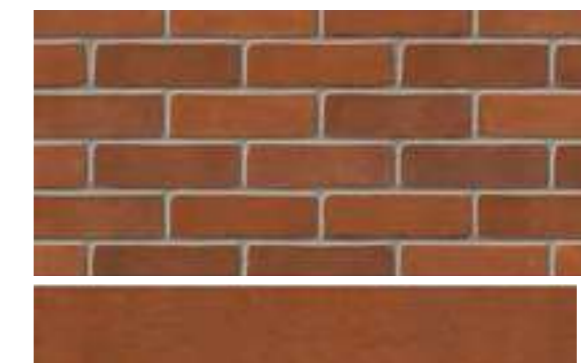

Swanage Imperial Red Stock 68mm Swanage 4316
STOCK

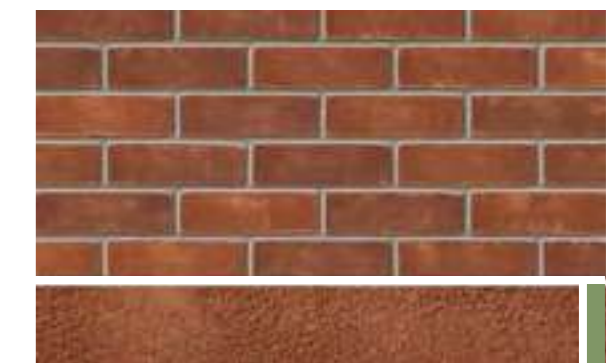

Heritage Red Blend Ellistown 4986
STOCK

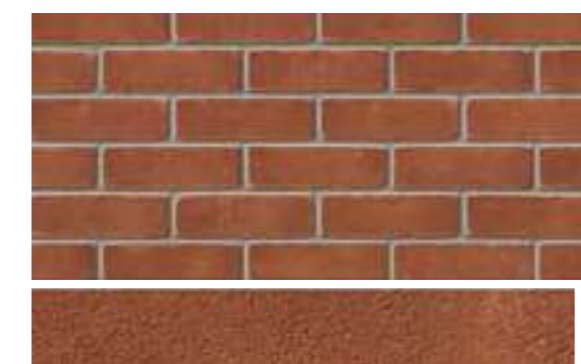

Dorset Red Stock Ellistown 4932
STOCK



New Sandhurst Stock Parkhouse 3057
STOCK



New Cavendish Stock Parkhouse 3018
STOCK

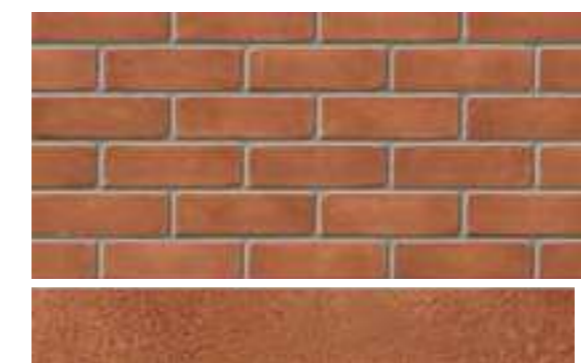

Leicester Red Stock Eclipse 0802
STOCK

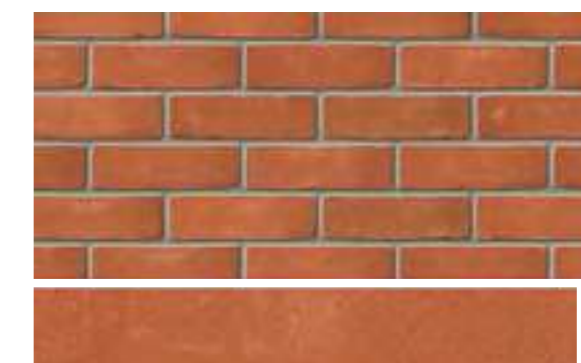

Laybrook Imperial Red Stock Laybrook 0756
STOCK



Swanage Imperial Light Stock 68mm Swanage 4317
STOCK

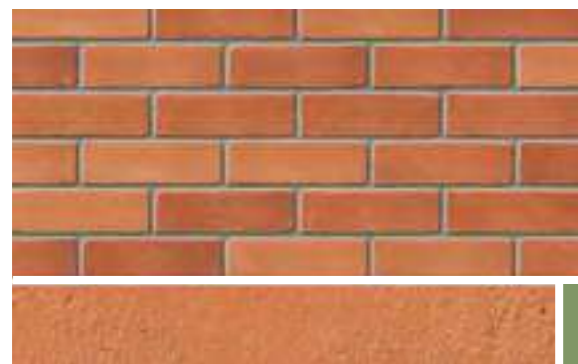

Heritage County Blend
STOCK Ellistown 4989

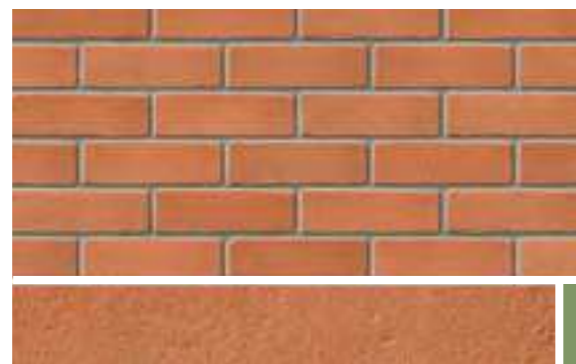

Leicester Orange Stock
STOCK Ellistown 4946

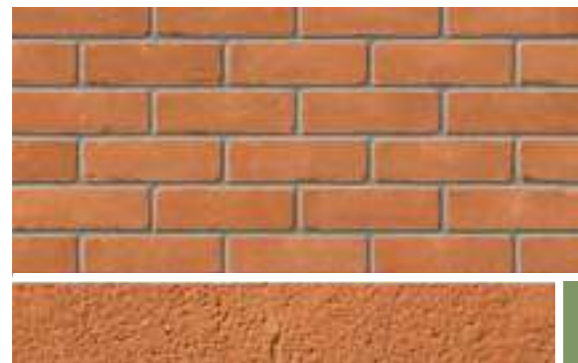

Berkshire Orange Stock
STOCK Laybrook 0771

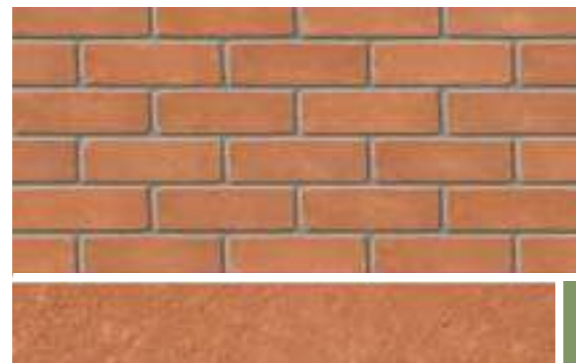

Mellow Regent Stock
STOCK Parkhouse 3010

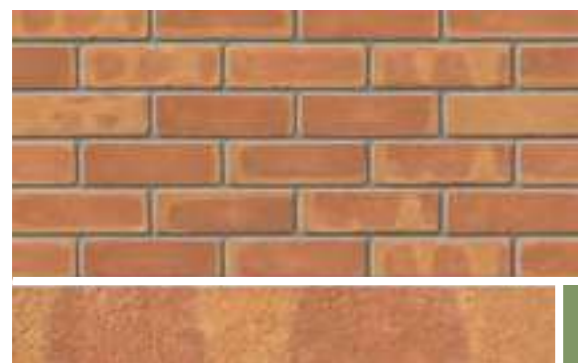

Mellow Ashridge Stock
STOCK Parkhouse 3025



Arden Olde Farmhouse Original
STOCK Ellistown 4985

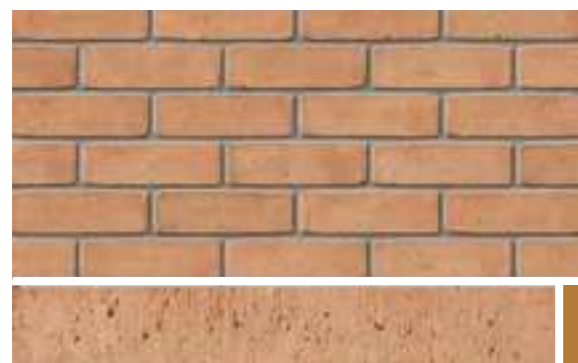

Arden Red
STOCK Ellistown 4980

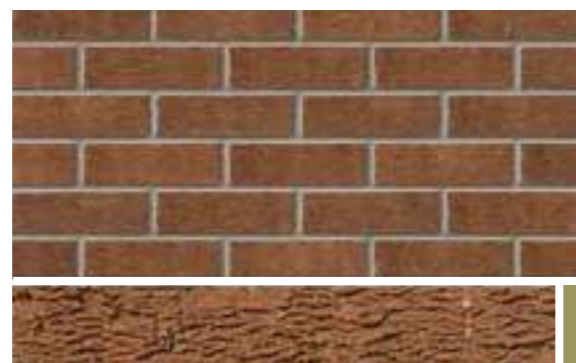

Aldridge Multi Rustic ●
WIRECUT Aldridge 0270



HERITAGE COUNTY BLEND:
BRENTWOOD PREPARATORY SCHOOL



MELLOW REGENT STOCK:
HOUSING, CROXLEY GREEN



ARDEN OLDE FARMHOUSE ORIGINAL:
TOWN HOUSES, WORDSLEY, WEST MIDLANDS



Brunswick Antique Red Cattybrook 0635
WIRECUT

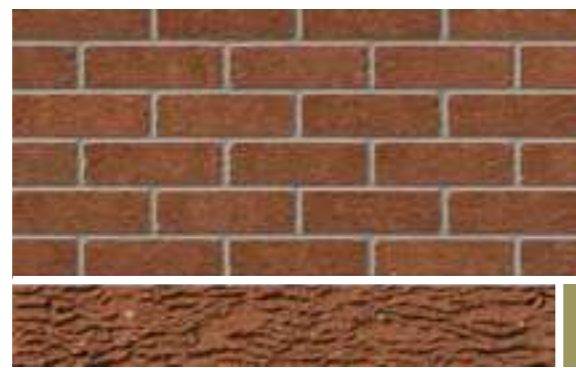

Anglian Red Rustic ● Aldridge 0352
WIRECUT

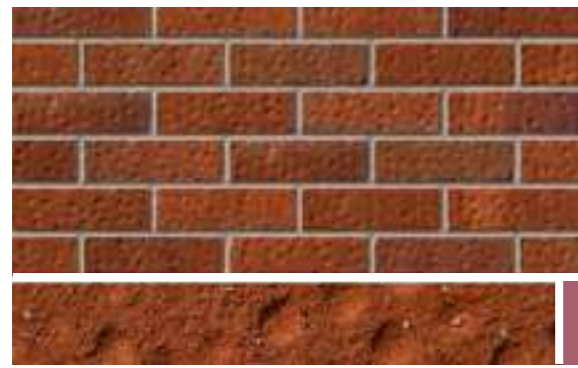

Tradesman Tudor Regent Cattybrook 0605
WIRECUT

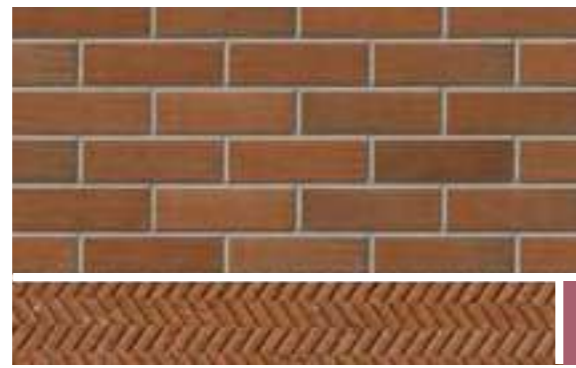

Tradesman Rustic Blend Cattybrook 0618
WIRECUT

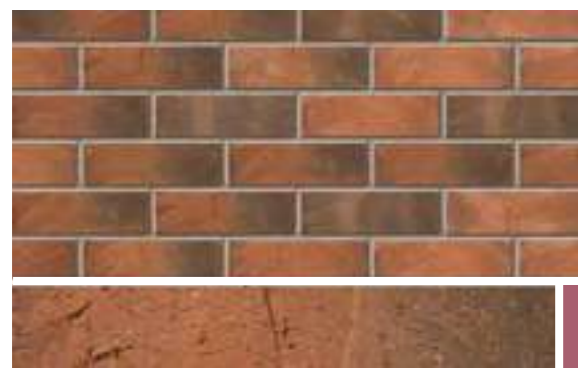

Grainger Antique Throckley 2769
WIRECUT

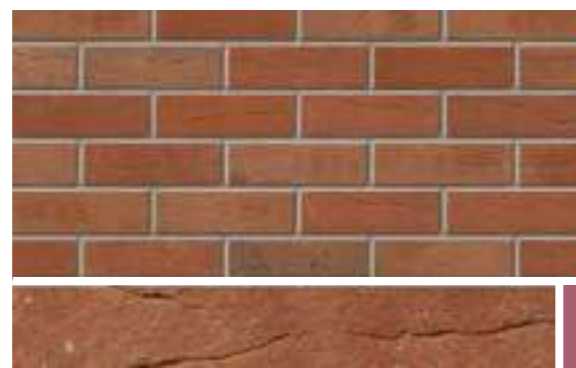

Brunswick Farmhouse Mixture Cattybrook 0636
WIRECUT

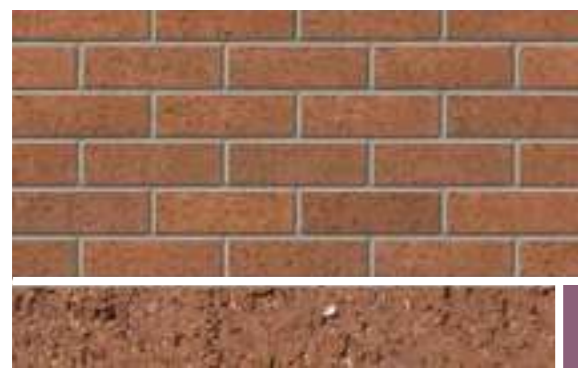

Bristol Red Cattybrook 0630
WIRECUT

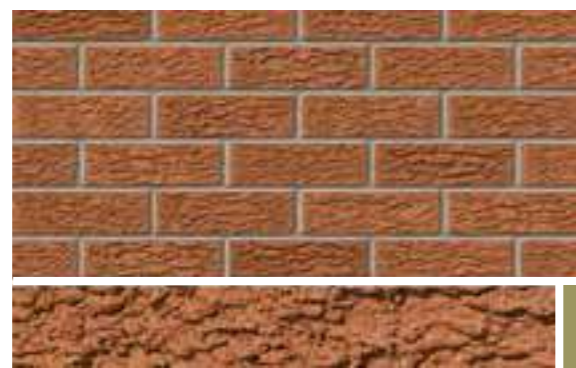

Manorial Red Chesterton 2902
WIRECUT

■ DRAGFACED ■ ROLLED ■ RUSTICATED ● ALSO AVAILABLE IN 73MM



BRUNSWICK FARMHOUSE MIXTURE:
POOLE GRAMMAR SCHOOL



BRIDGWATER WEATHERED RED:
NURSING HOME, CHESSINGTON

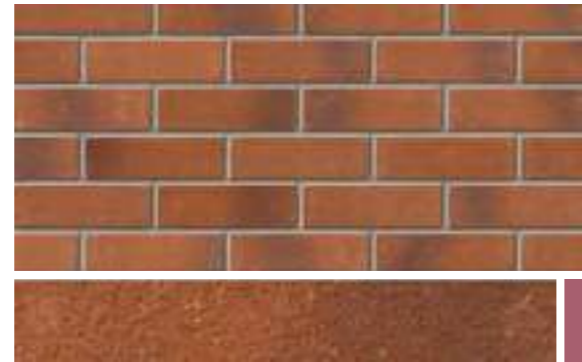

Bridgwater Weathered Red
WIRECUT Cattybrook 0661

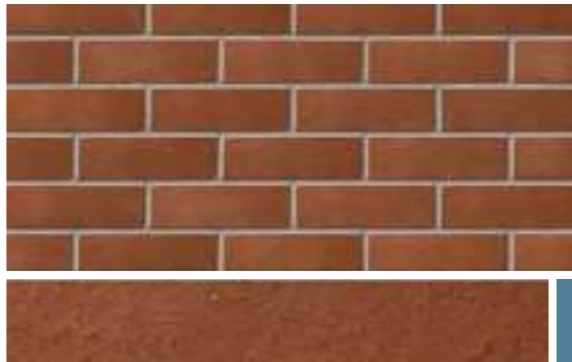

Aldridge Smooth Red ●
WIRECUT Aldridge 0272

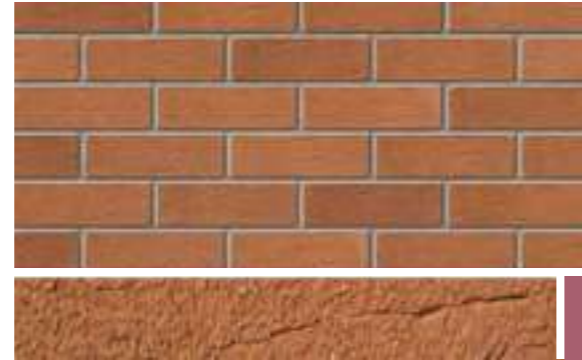

Grampian Red
WIRECUT Chesterton 2965

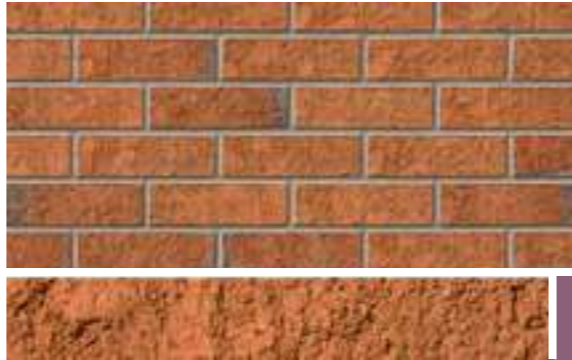

Calderstone Russett
WIRECUT Ravenhead 3578

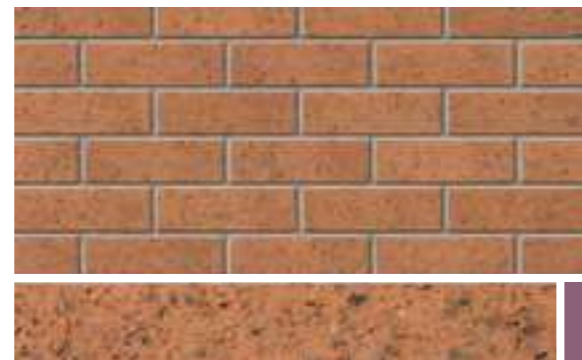

Throckley Old English
WIRECUT Throckley 2724

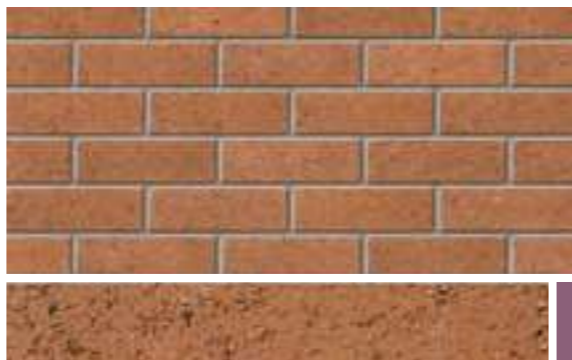

Mixed Red Textured
WIRECUT Throckley 2703

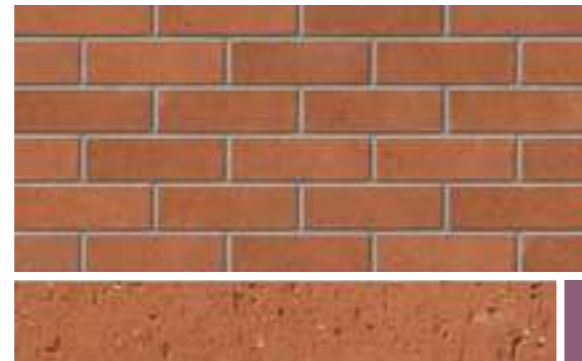

Hollington Blend
WIRECUT Chesterton 2916

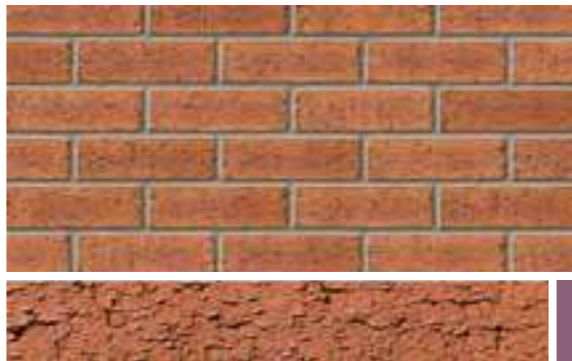

Hearted Red Rustic
WIRECUT Ravenhead 3516



ALDRIDGE SMOOTH RED: 19 WOLVERHAMPTON



THROCKLEY OLD ENGLISH: WEYMOUTH HOUSE,
NEWCASTLE-UPON-TYNE

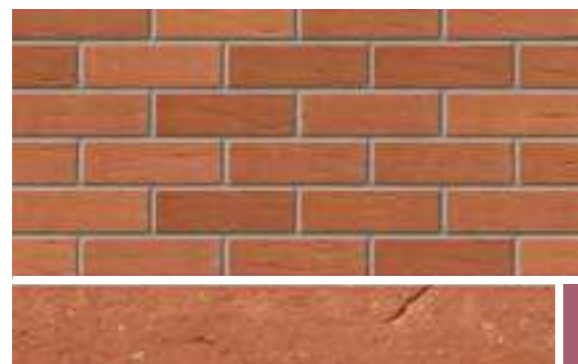

Brunswick Red
WIRECUT Cattybrook 0637

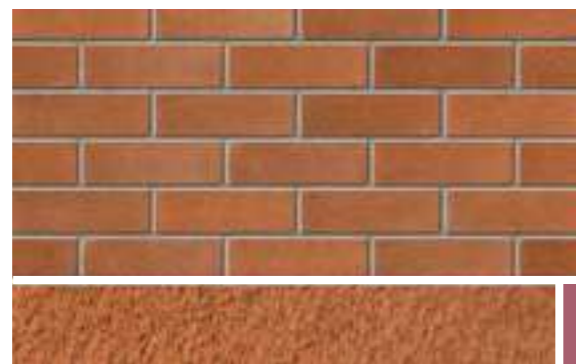

Alderley Orange
WIRECUT Chesterton 2946

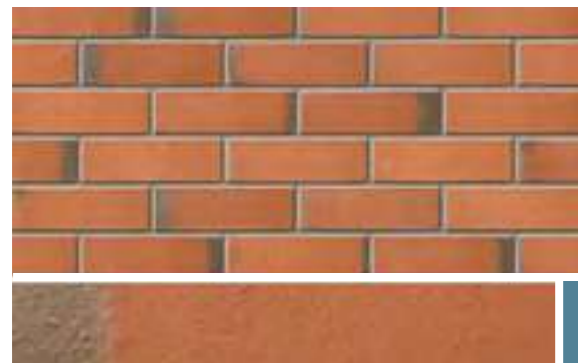

Chester Red Blend
WIRECUT Ravenhead 3596

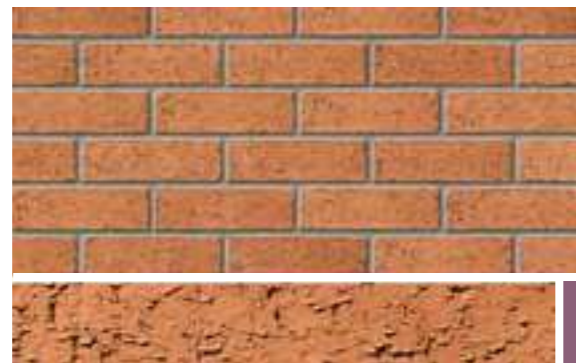

Ravenhead Red Rustic
WIRECUT Ravenhead 3502

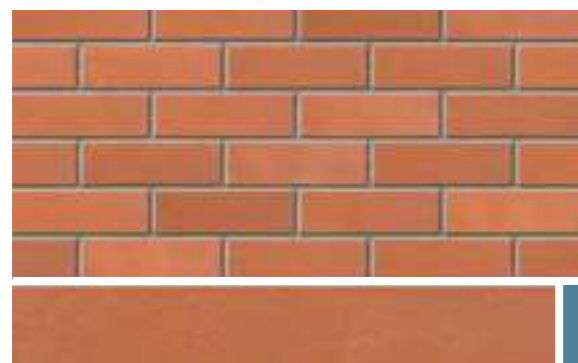

Cheddar Red
WIRECUT Cattybrook 0610

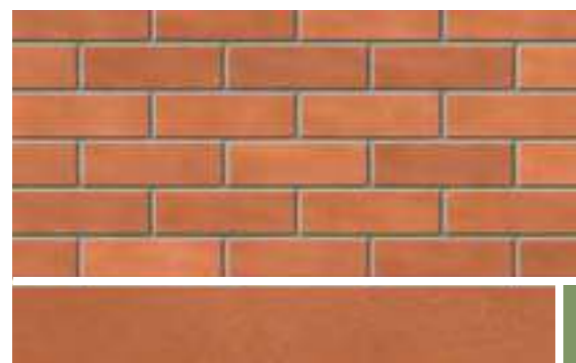

Dorking Red
WIRECUT South Holmwood 4125

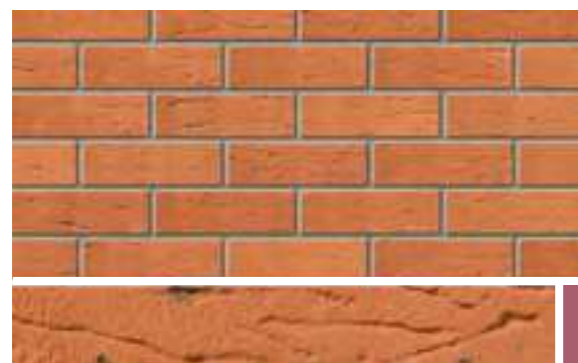

Surrey County Red
WIRECUT South Holmwood 4132

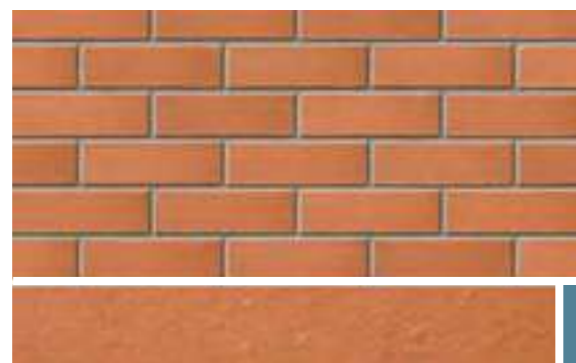

Ravenhead Red Smooth ●
WIRECUT Ravenhead 3501

■ SMOOTH ■ ROLLED ■ SANDCREASED ■ SANDFACED ● ALSO AVAILABLE IN 73MM



CHESTER RED BLEND: OLD TRAFFORD
CRICKET GROUND, MANCHESTER



GRAINGER AUTUMN: SHELTERED ACCOMODATION, PONTELAND

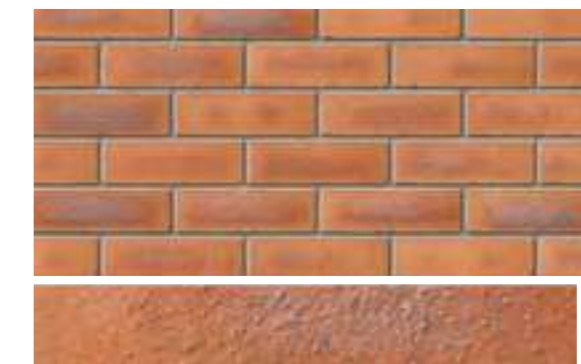

Smooth Village Mixture
WIRECUT Ravenhead 3536

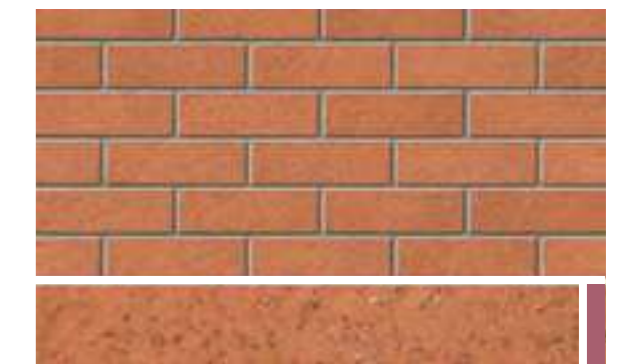

Mercia Orange
WIRECUT Chesterton 2974

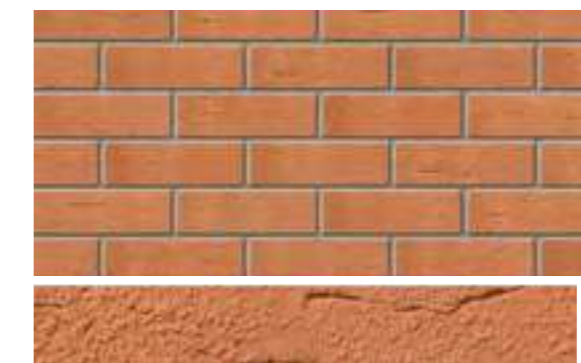

Surrey Orange
WIRECUT South Holmwood 4131

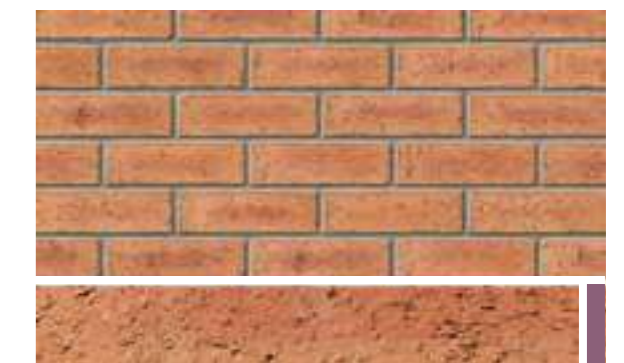

Oldcott Rustic
WIRECUT Ravenhead 3532

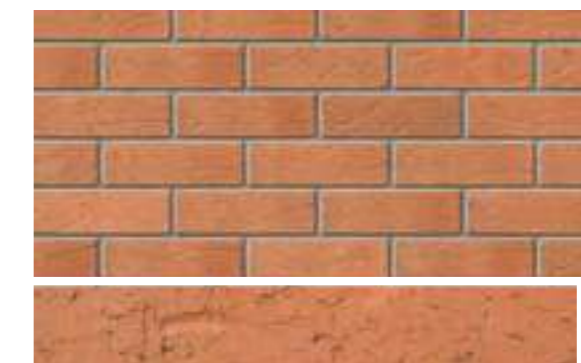

Hadrian Red
WIRECUT Throckley 2709



Grainger Autumn
WIRECUT Throckley 2770

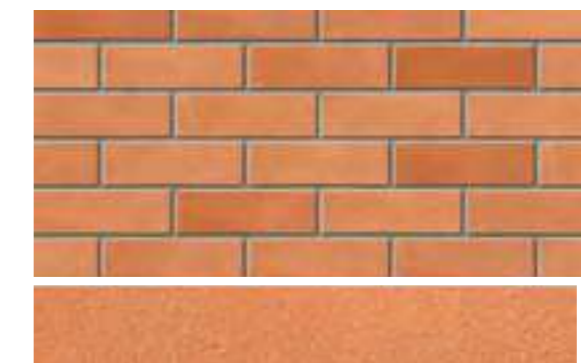

Holmwood Natural
WIRECUT South Holmwood 4157

IMAGE: KILCREGGAN MULTI WIRECUT,
PRIVATE APARTMENTS, GORBALS, GLASGOW

RED MULTI BRICKS

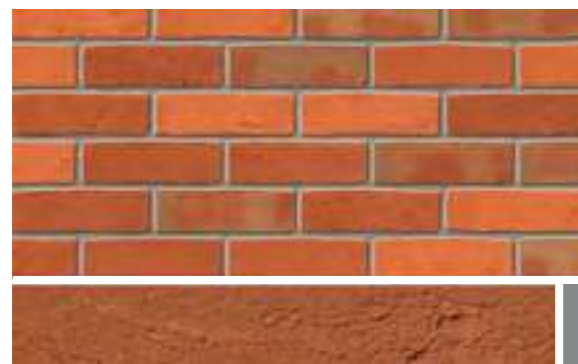

Kingston H/M Light Red Multi Swanage 4356
HANDMADE



Swanage H/M Light Red Multi Swanage 4303
HANDMADE

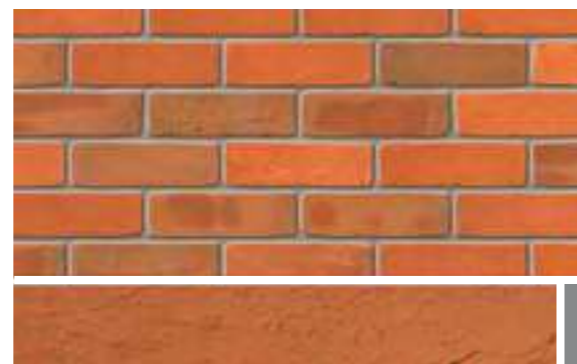

Kingston H/M Light Red Multi Imperial Swanage 4356
HANDMADE



Borrowdale Blend Birtley 2631
WATERSTRUCK



Beamish Blend Birtley 2601
WATERSTRUCK

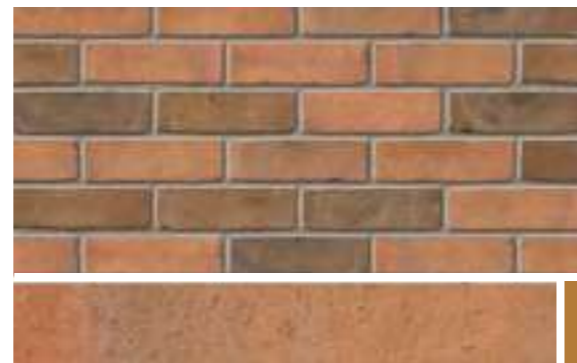

Cumberland Blend Birtley 2629
WATERSTRUCK

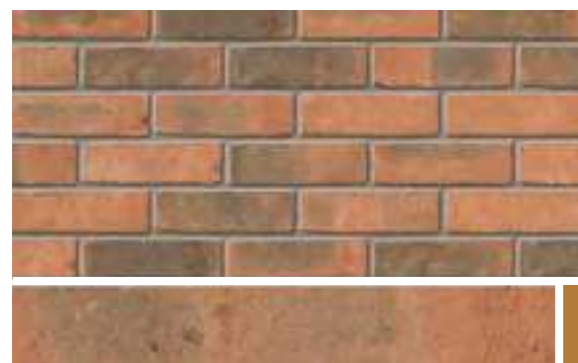

Birtley Olde English Birtley 2602
WATERSTRUCK



Townhouse Blend Birtley 2623
WATERSTRUCK

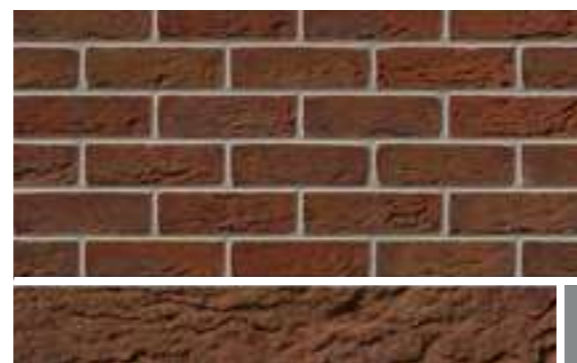

Bradgate Claret Leicester 0031
STOCK



Bexhill Purple Multi Ashdown 4033
STOCK

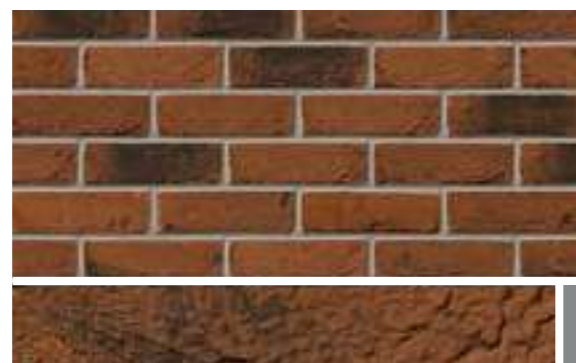

Ivanhoe Antique Leicester 0060
STOCK



Ivanhoe Katrina Multi Leicester 0059
STOCK



BEAMISH BLEND: ARLEY HOMES, ATHERTON



CUMBERLAND BLEND: JOHN MORDEN CENTRE



THAKEHAM RED MULTI STOCK: APARTMENTS, BATH ROAD, MAIDENHEAD

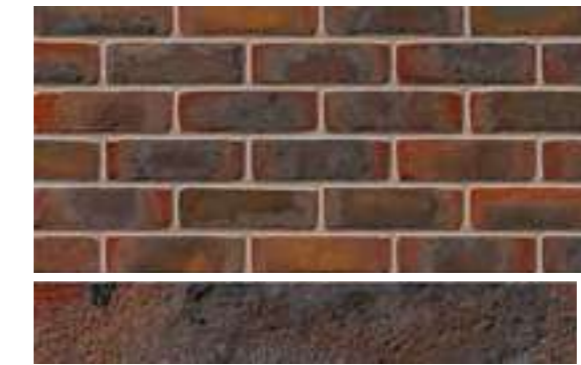

Chailey Medium Multi Stock Chailey 4528
STOCK

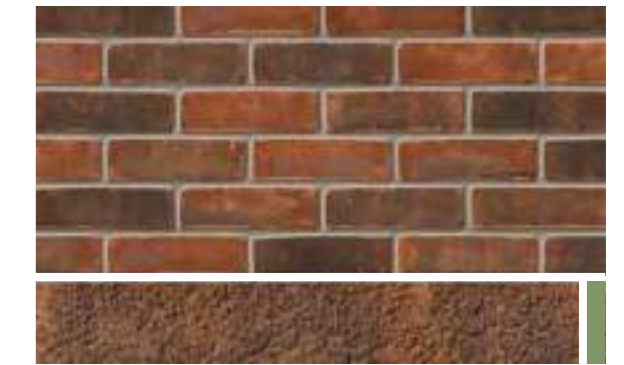

Cissbury Red Multi Stock Laybrook 0767
STOCK

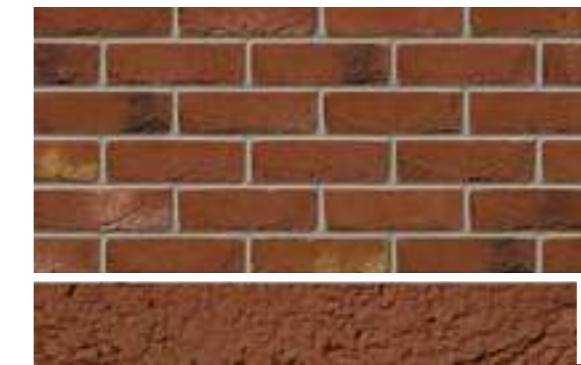

Ivanhoe Cottage Blend Leicester 0055
STOCK

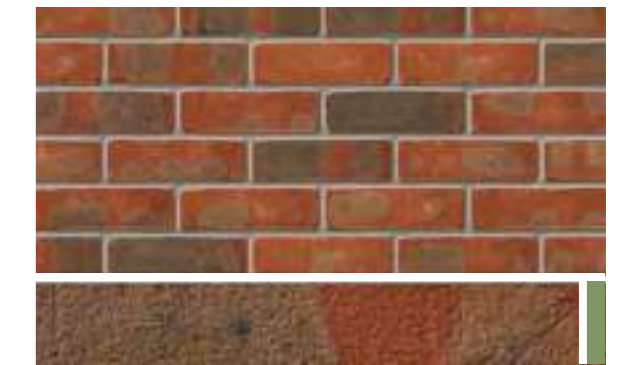

Thakeham Red Multi Stock Laybrook 0709
STOCK

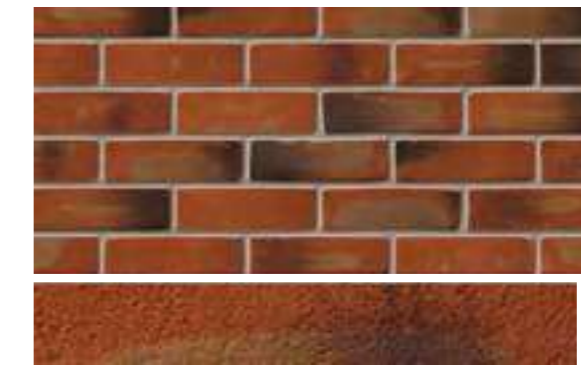

Leicester Weathered Multi Ellistown 4935
STOCK

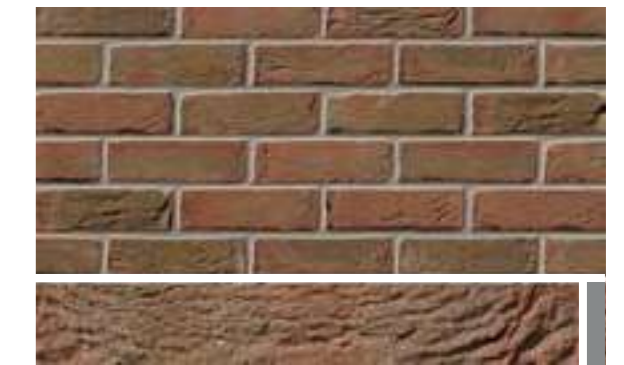

Bradgate Regal Leicester 0021
STOCK



Leicester Weathered Red Stock Eclipse 0813
STOCK



Cottage Mixture Ashdown 4001
STOCK



Bexhill Dark Stock Ashdown 4009

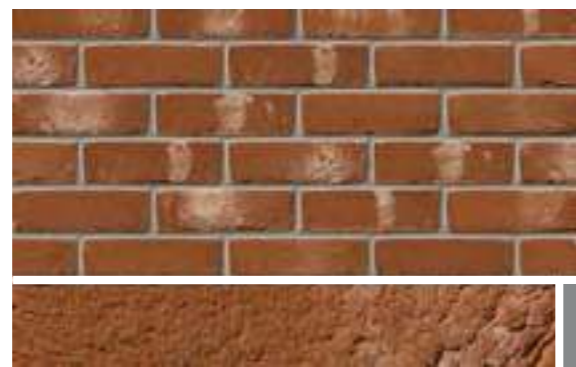

Ivanhoe Mellow Red Stock Leicester 0058

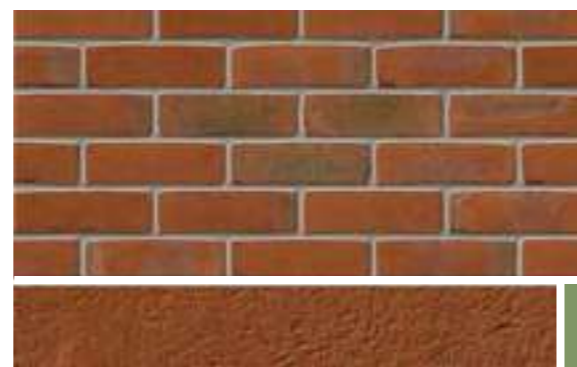

Laybrook Multi Orange Stock Laybrook 0772



Ramian Red Stock Blend Stock Ravenhead 3613



Ramian Red Multi Stock Stock Ravenhead 3615

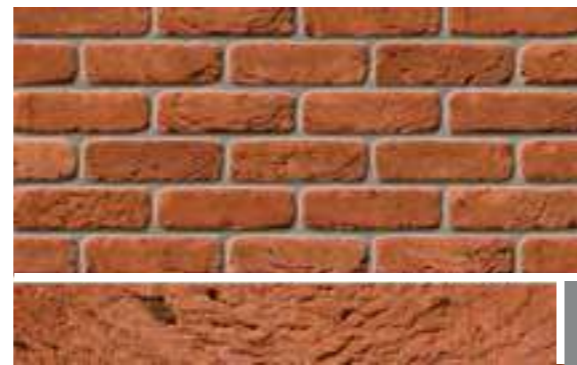

Ramian Red Stock Stock Ravenhead 3616

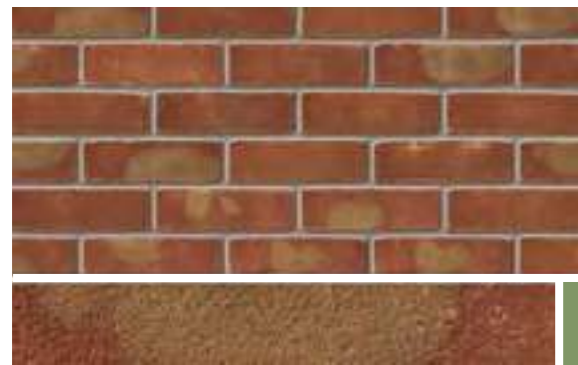

Dorset Multi Red Stock Stock Ellistown 4941



Leicester Autumn Multi Stock Ellistown 4937

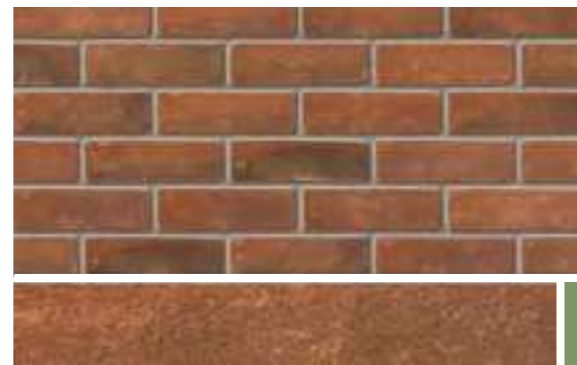

Audley Red Mixture Stock Stock Parkhouse 3022



Weston Red Multi Stock Stock Parkhouse 3055



New Chailey Stock Stock Chailey 4501



IVANHOE MELLOW RED: LAURELS, BOLTON



SANDFACED

BEXHILL RED: SUNRISE SENIOR LIVING, HALE BARNS



Hamsey Mixed Stock
STOCK Chailey 4517

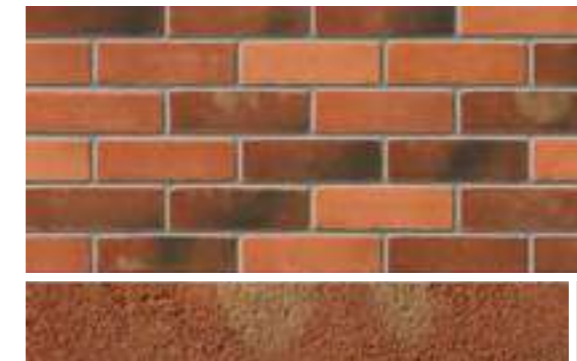

Rustique Blend
STOCK Ellistown 4947



Betley Cottage Blend
STOCK Parkhouse 3058



Ivanhoe Westminster
STOCK Eclipse 0825



Ivanhoe Olde Village
STOCK Leicester 0062

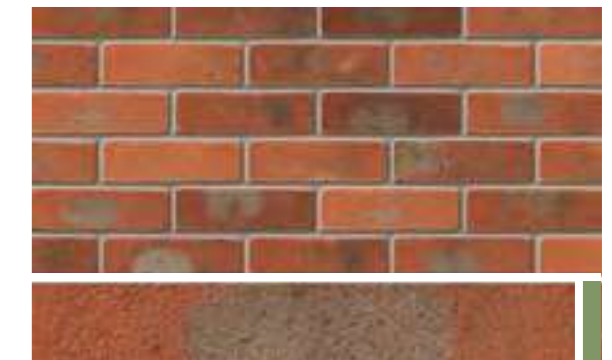

Heritage Light Red Multi
STOCK Ellistown 4977

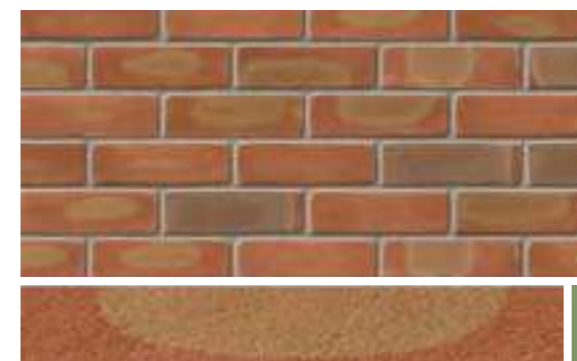

Leicester Multi Red Stock
STOCK Eclipse 0812



Grosvenor Autumn Flame
STOCK Leicester 0176

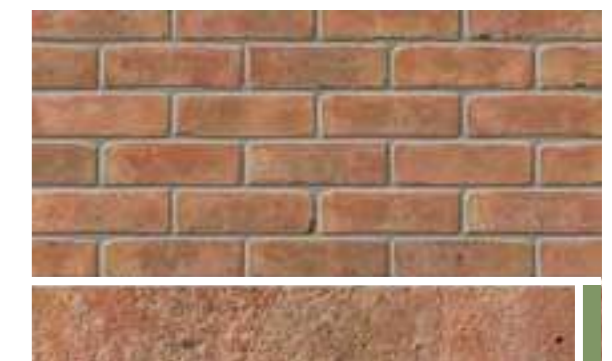

Petworth Multi Stock
STOCK Laybrook 0700



Arden Weathered Red
STOCK Ellistown 4982



Bexhill Red
STOCK Ashdown 4010



Lambourn Orange Multi Stock
STOCK Parkhouse 3035



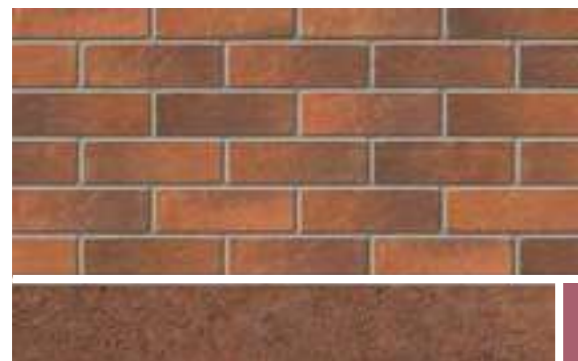

Mercia Orange Multi Chesterton 2976
WIRECUT

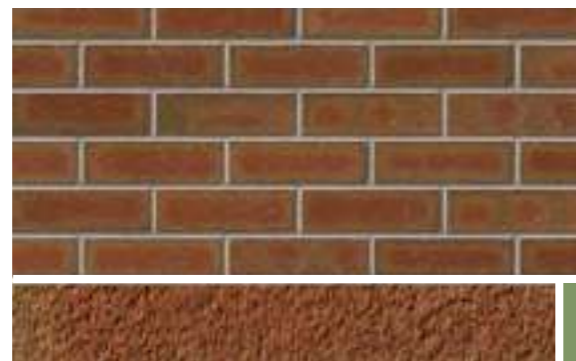

Alderley Mixture Chesterton 2948
WIRECUT

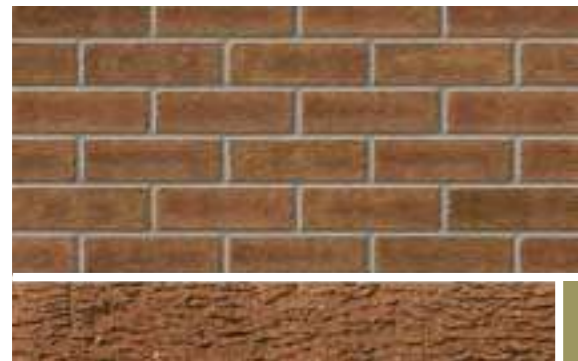

Staffordshire Multi Rustic Aldridge 0289
WIRECUT

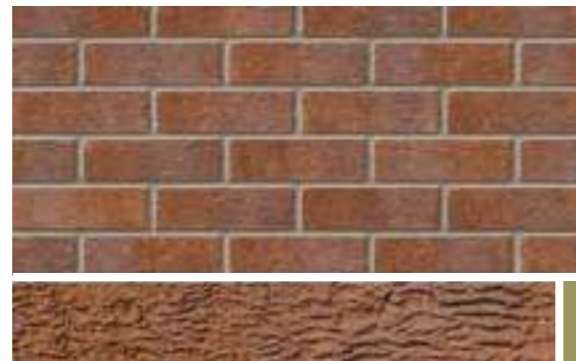

Anglian Red Multi Rustic Aldridge 0257
WIRECUT



Oakleigh Red Blend Ravenhead 3527
WIRECUT

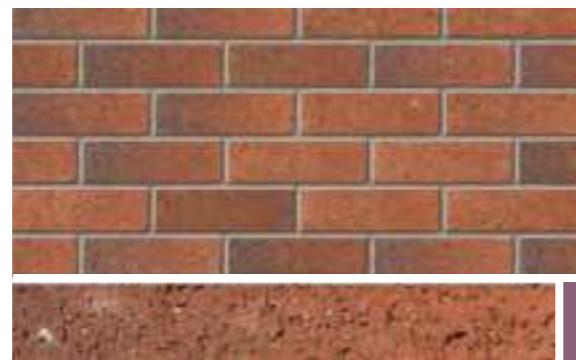

Bristol Mixed Red Cattybrook 0655
WIRECUT

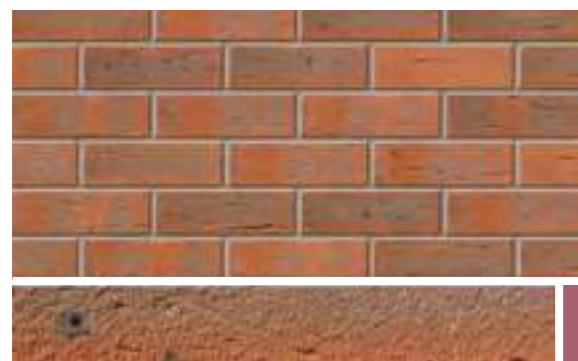

Surrey Russet South Holmwood 4136
WIRECUT

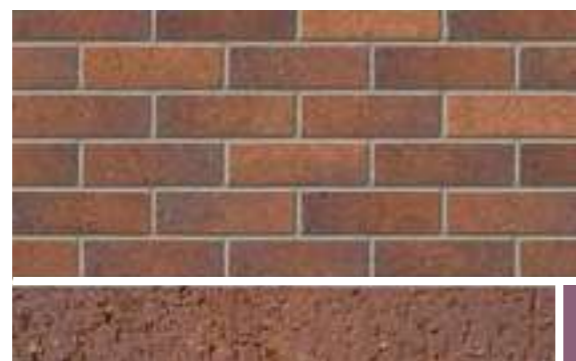

Westbrick Red Purple Multi Cattybrook 0662
WIRECUT



HANCHURCH MIXTURE: WATERSIDE, HARPENDEN



Tradesman Heather Mixture Chesterton 2949
WIRECUT

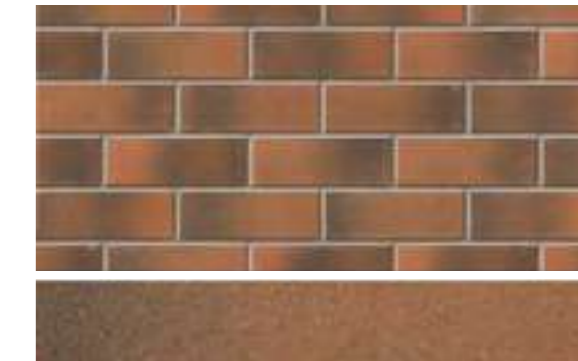

Callerton Weathered Red 73mm Throckley 2764
WIRECUT

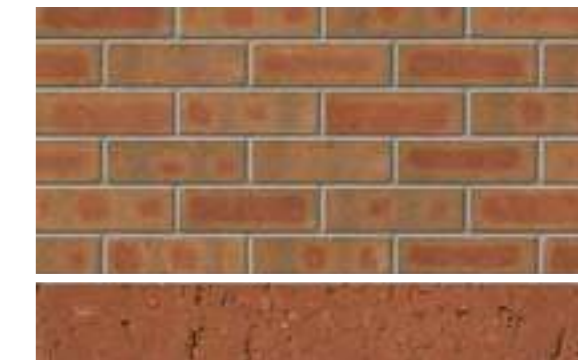

Hanchurch Mixture Chesterton 2922
WIRECUT



Alderley Cottage Blend Chesterton 2977
WIRECUT



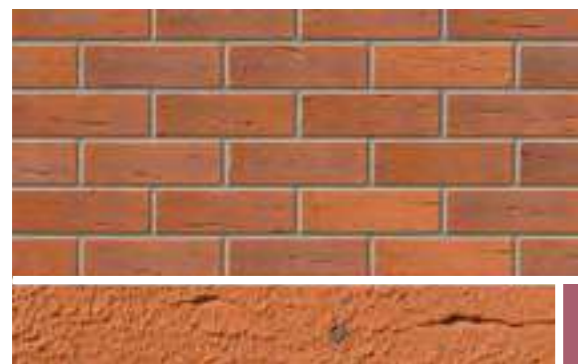

Surrey Red Multi
WIRECUT South Holmwood 4133

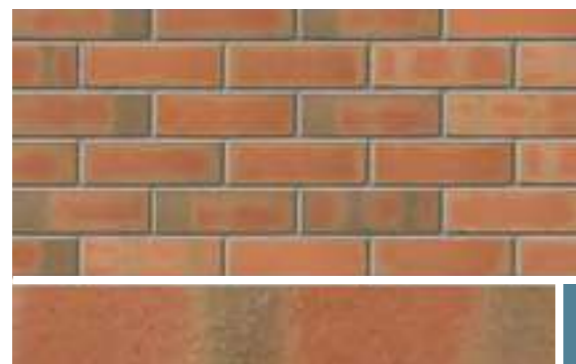

Multi Red Smooth
WIRECUT Chesterton 2934

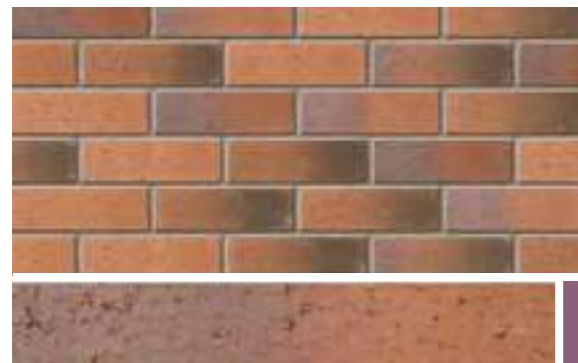

Kilreggan Multi Wirecut
WIRECUT Throckley 2767

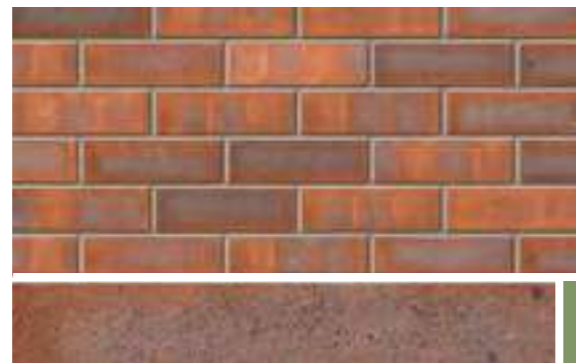

Reigate Purple
WIRECUT South Holmwood 4148

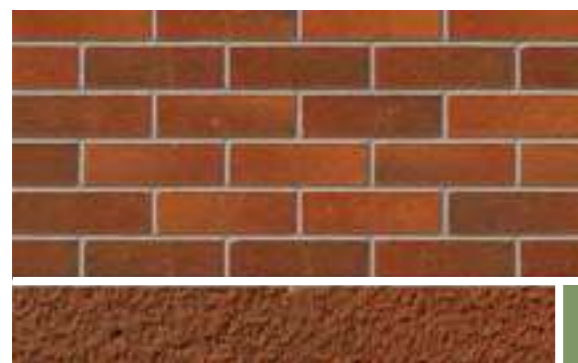

Alderley Russet Blend
WIRECUT Chesterton 2978

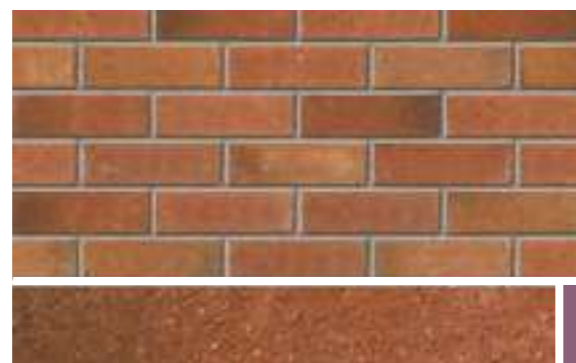

Bristol Orange Blend
WIRECUT Cattybrook 0656

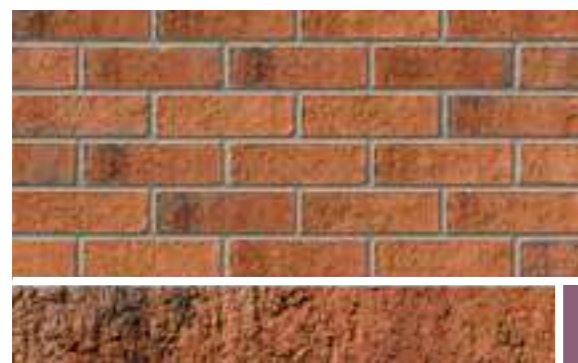

Calderstone Claret
WIRECUT Ravenhead 3577

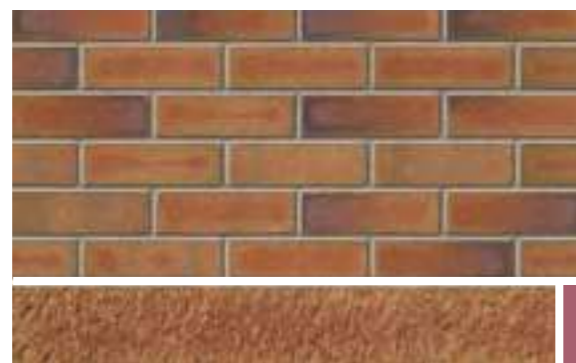

Alderley Burgundy
WIRECUT Chesterton 2947



KILREGGAN MULTI WIRECUT: STRAND ST, KILMARNOCK



REIGATE PURPLE: CATHERINE HUGHES BUILDING, OXFORD



CALDERSTONE CLARET: BOVIS-NETHER HALL PARK

SMOOTH DRAGFACED ROLLED SANDFACED

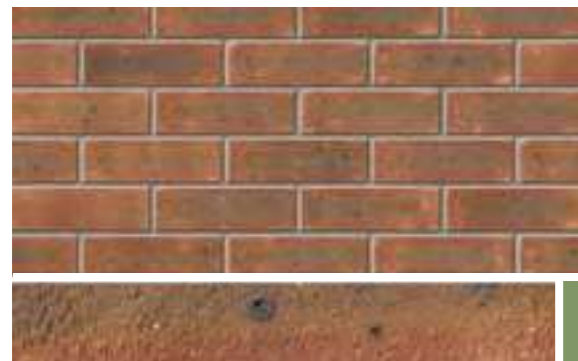

Balmoral Dorket Head 2405
WIRECUT



Tradesman Light Rustic Blend Ravenhead 3542
WIRECUT



Wylam Olde Blend Throckley 2800
WIRECUT

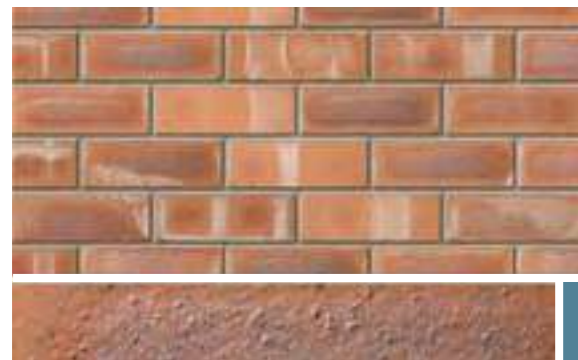

Pre War Common Ravenhead 3594
WIRECUT



CHESHIRE WEATHERED: PRIVATE HOME CAUGHALL ROAD, CHESTER

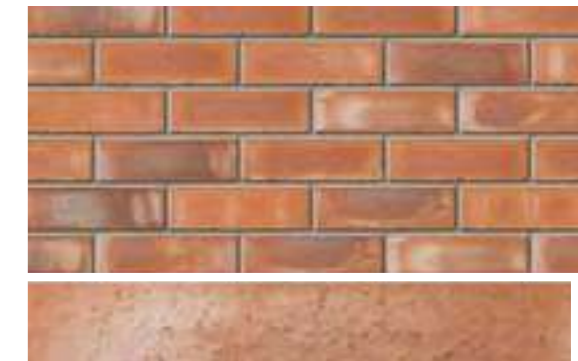

Tradesman Common Ravenhead 3598
WIRECUT



Cheshire Weathered Ravenhead 3541
WIRECUT



Alnwick Blend Throckley 2801
WIRECUT

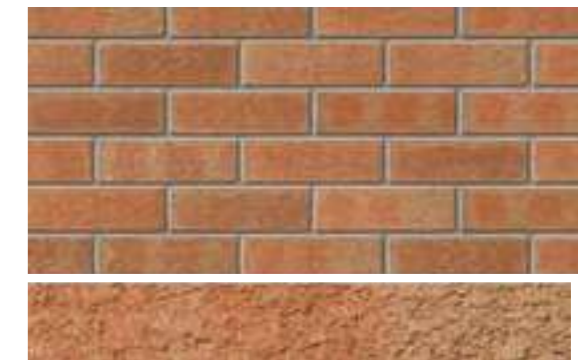

Chillingham Blend Throckley 2802
WIRECUT

SMOOTH DRAGFACED ROLLED SANDFACED



HARDWICKE SHERWOOD BLAZE: HOUSING, CHEQUERFIELD



WORSLEY WEATHERED: HOUSING, SOUTHPORT, MERSEYSIDE



TRAFFORD MULTI RUSTIC: IMAGING UNIT, HOSPITAL, BEBINGTON, WIRRAL



Roughdales Red Multi Rustic Ravenhead 3579
WIRECUT



Windsor Dorket Head 2407
WIRECUT



Hardwicke Sherwood Blaze Dorket Head 2417
WIRECUT

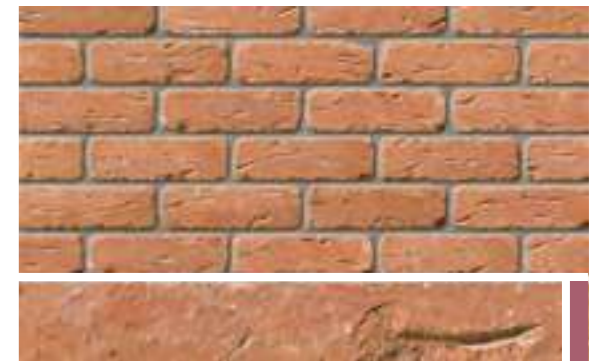

Worsley Weathered Ravenhead 3509
WIRECUT

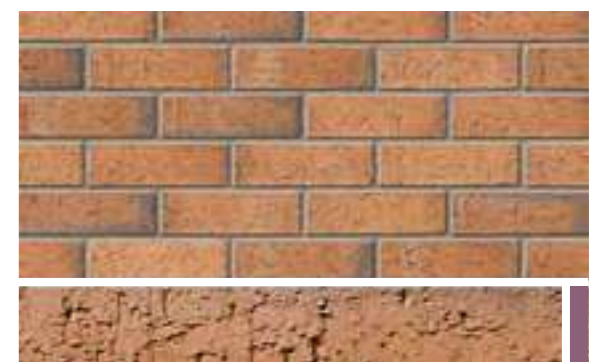

Trafford Multi Rustic Ravenhead 3576
WIRECUT

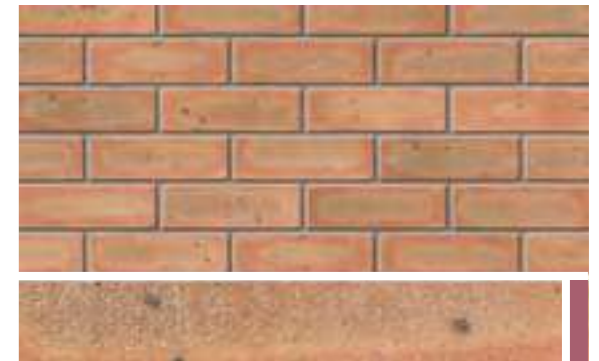

Hardwicke Welbeck Red Mixture Dorket Head 2423
WIRECUT

IMAGE: MIX OF BIRTLEY OLDE ENGLISH BUFF & WHITE ENGOBE,
STUDENT ACCOMMODATION, MAYNOOTH UNIVERSITY, IRELAND

BUFF, YELLOW AND WHITE BRICKS

BRADGATE MULTI CREAM: MUGDOCK HOUSE, GLASGOW



Marlborough Stock Stock Parkhouse 3016



Bradgate Multi Cream Stock Leicester 0030



Bradgate Light Buff Stock Leicester 0025



Bristol Gold Wirecut Cattybrook 0634



Brunswick Buff Wirecut Cattybrook 0640



Romsey Wirecut Clerkenwell A5172A



Gault Cream Stock Stock Eclipse 0803



Moseley Wirecut Clerkenwell A5162A



Hadrian Buff Wirecut Throckley 2708



Sandalwood Wirecut Throckley 2731



Mixed Buff Rustic Wirecut Throckley 2760

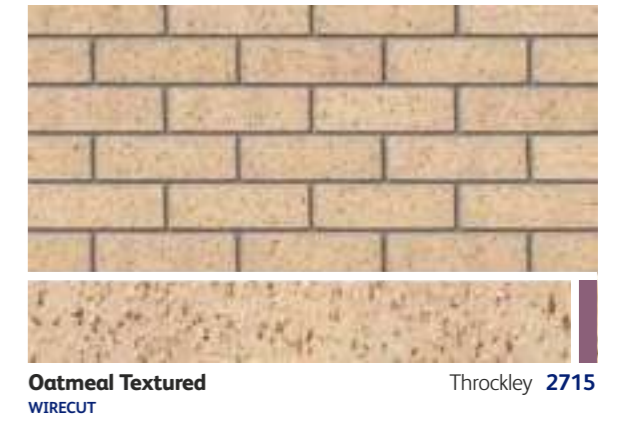

Oatmeal Textured Wirecut Throckley 2715

CHEDDAR GOLDEN: MOSQUE, READING



Continental Buff Clerkenwell **A5149A**
WIRECUT



Hardwicke Minster Cream Blend Dorket Head **2419**
WIRECUT



Cheddar Golden Cattybrook **0611**
WIRECUT



Sandringham Dorket Head **2406**
WIRECUT



Stuart Buff Throckley **2738**
WIRECUT

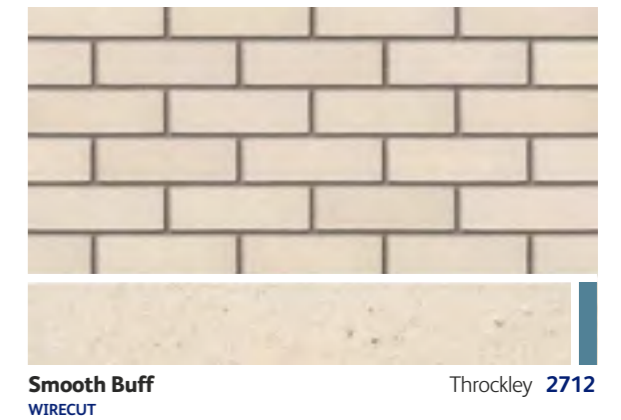

Smooth Buff Throckley **2712**
WIRECUT



Chorlton Clerkenwell **A5168A**
WIRECUT



Finniston Clerkenwell **A5171A**
WIRECUT



WHITE ENGOBE: THE PUMP HOUSE



Finnieston Smooth Clerkenwell **A5091A**
WIRECUT



Winstar Clerkenwell **A5084A**
WIRECUT



New Diana Clerkenwell **A5143A**
WIRECUT



White Engobe Clerkenwell **A5145A**
WIRECUT

IMAGE: IVANHOE CREAM, BROOKFIELD
SCHOOL OF BUSINESS

BUFF AND YELLOW MULTI BRICKS

BUFF AND YELLOW MULTI BRICKS



Northern Buff Birtley 2618
WATERSTRUCK



Birtley Olde English Buff Birtley 2605
WATERSTRUCK



Millhouse Blend Birtley 2630
WATERSTRUCK



Funton Old Chelsea Yellow Ashdown 4053
STOCK



Arundel Yellow Multi Stock Laybrook 0713
STOCK



Sevenoaks Yellow Stock Laybrook 0730
STOCK



Ivanhoe Athena Blend Leicester 0061
STOCK



Bradgate Harvest Antique Leicester 0028
STOCK

■ SANDCREASED ■ DISTRESSED ■ SANDFACED



FUNTON OLD CHELSEA YELLOW: THE OFFICERS' HOUSE ROYAL ARSENAL, LONDON



COLERIDGE YELLOW MULTI: PARK CENTRAL, ELEPHANT PARK



Coleridge Yellow Multi
STOCK Ashdown 4027



Bradgate Golden Purple
STOCK Leicester 0023



Cooksbridge Yellow Clamp Stock
STOCK Chailey 4512



Bruges Blend
STOCK Leicester 0101



Ivanhoe Cream Original
STOCK Leicester 0054



Niveus
STOCK Leicester A0083A



Ramian Buff Stock Blend
STOCK Ellistown 3614



Ramian Buff Multi Stock
STOCK Ravenhead 3611



Ramian Buff Stock
STOCK Ellistown 3612



New Ivanhoe Cream
STOCK Eclipse 0805



Cooksbridge Rustic Blend
STOCK Chailey 4527



Dinian Blend
STOCK Leicester 0102



Leicester Multi Cream Stock Eclipse 0189



Floriana Blend Stock Leicester 0104



Amato Blend Stock Leicester 0103



Tay Buff Multi Wirecut Throckley 2790



Dilston Blend Wirecut Throckley 2803



Tradesman Buff Multi Wirecut Cattybrook 0619



Anglian Beacon Sahara Wirecut Aldridge 0258



Brunswick Autumn Wirecut Cattybrook 0638



BRUNSWICK AUTUMN: BISHOP CHALLONER SPORTS CENTRE, BIRMINGHAM

BRUNSWICK WILTON YELLOW: KIDBROOKE VILLAGE



Bristol Buff Multi Cattybrook 0657
WIRECUT

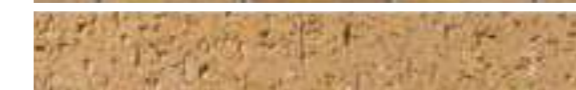

Cavendish Dorket Honeygold Dorket Head 2434
WIRECUT



Anglian Buff Multi Rustic Aldridge 0353
WIRECUT



Brunswick Wilton Yellow Cattybrook 0643
WIRECUT



Hardwicke Minster Beckstone Mixture Dorket Head 2428
WIRECUT



Tradesman Millgate Buff Cattybrook 0620
WIRECUT



Grainger Gold Throckley 2771
WIRECUT



Hardwicke Minster Sandstone Mixture Dorket Head 2418
WIRECUT

IMAGE: HIMLEY EBONY BLACK,
OLYMPIC SUB-STATION, STRATFORD

BLACK BRICKS



BLACK SMOOTH: SCHOOL ACADEMY, SCUNTHORPE, LINCOLNSHIRE



Clapton Wirecut Clerkenwell **A5170A**



Black Smooth Wirecut Clerkenwell **A5144A**



Holbrook Sandfaced Dark Wirecut South Holmwood **4120**



Holbrook Sandfaced Black Wirecut South Holmwood **4149**



HOLBROOK SANDFACED DARK: STOCKLAND GREEN SCHOOL

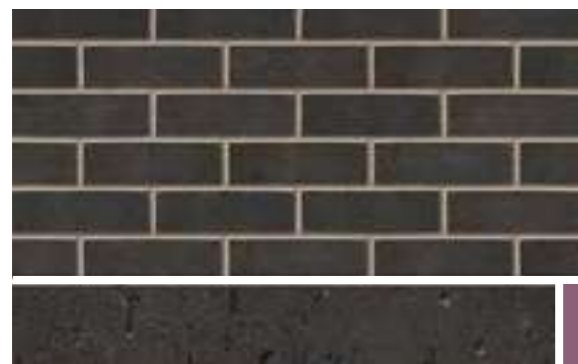

Himley Ebony Black
WIRECUT Aldridge 0354



Emral
WIRECUT Clerkenwell A5087A



Clapton Blue Black
WIRECUT Clerkenwell A5093A



Jericho Smooth
WIRECUT Clerkenwell A5166A



Jericho Textured
WIRECUT Clerkenwell A5092A



HIMLEY EBONY BLACK: OLYMPIC SUB-STATION, STRATFORD

IMAGE: STAFFORDSHIRE SLATE BLUE
SMOOTH, PRIVATE HOUSING, GLASGOW

BLUE AND BRINDLE BRICKS



Staffordshire Blue Brindle Dragface Lodge Lane **2221**
WIRECUT

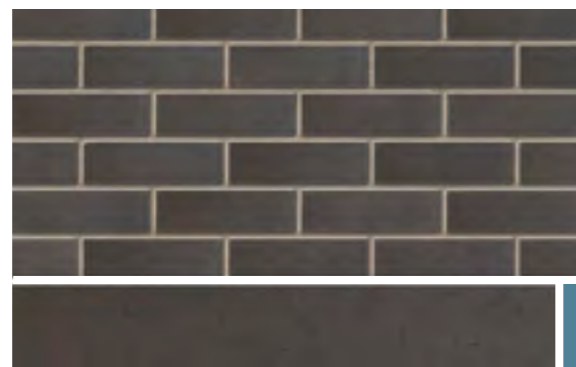

Atlas Smooth Blue Lodge Lane **2249**
WIRECUT



Staffordshire Slate Blue Smooth Lodge Lane **2232**
WIRECUT



Riven Blue Lodge Lane **A2213A**
WIRECUT



Riven Brindle Lodge Lane **A2214A**
WIRECUT



Staffordshire Blue Brindle Smooth Lodge Lane **2220**
WIRECUT



STAFFORDSHIRE SLATE BLUE: SMOOTH FERMOY ROAD, LONDON

IMAGE: CAPITAL BROWN MULTI STOCK,
BARRATTS, STONEGROVE

BROWN BRICKS

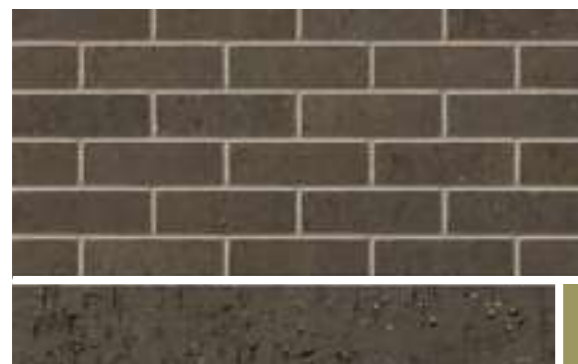

Himley Dark Brown Rustic Aldridge **0355**
WIRECUT

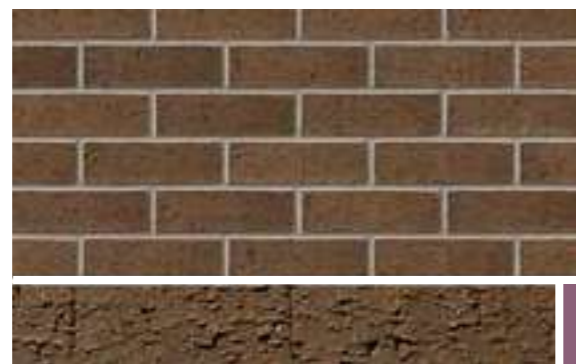

Bracken Brown Rustic Ravenhead **3505**
WIRECUT



Cheddar Brown Cattybrook **0612**
WIRECUT

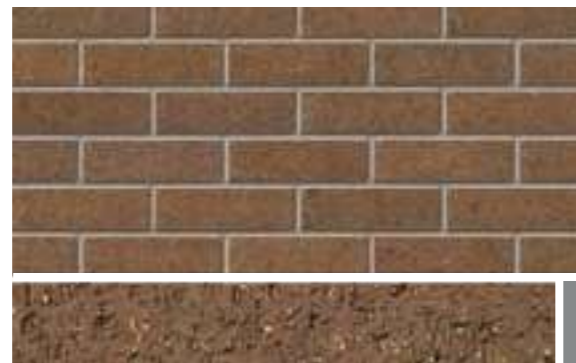

Bristol Brown Cattybrook **0628**
WIRECUT



Holbrook Sandfaced Brown South Holmwood **4119**
WIRECUT



Milburn Ashen Brown Blend Throckley **2775**
WIRECUT



Birtley Brown Birtley **2634**
WATERSTRUCK

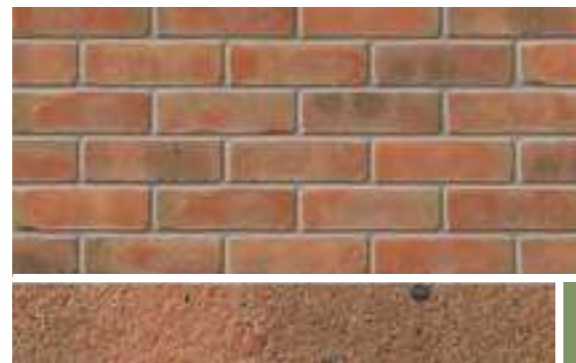

Capital Brown Multi Stock Laybrook **0714**
STOCK



MILBURN ASHEN BROWN BLEND: HERIOT WATT UNIVERSITY



HOLBROOK SANDFACED BROWN: PORTSLADE ALDRIDGE COMMUNITY ACADEMY



CAPITAL BROWN MULTI STOCK: BARRATTS, STONEGROVE

IMAGE: BRUNSWICK TRYFAN GREY,
APARTMENTS, GOVAN, GLASGOW

GREY BRICKS



Dark Grey
WIRECUT
Clerkenwell **A5146A**



Coledale
WIRECUT
Clerkenwell **A5088A**



Caldew
WIRECUT
Clerkenwell **A5089A**



Gowan
WIRECUT
Clerkenwell **A5086A**



Partick
WIRECUT
Clerkenwell **A5169A**



Light Grey
WIRECUT
Clerkenwell **A5147A**



Montpelier
WIRECUT
Clerkenwell **A5164A**

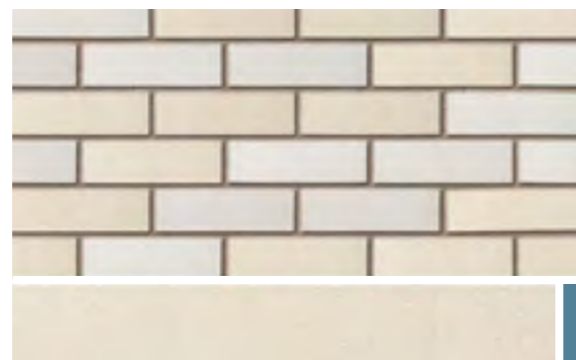

Kensey
WIRECUT
Clerkenwell **A5085A**

■ SMOOTH





Olde English Grey Birtley 2640
WATERSTRUCK



Arden Weathered Grey Ellistown 4990
STOCK



Leicester Weathered Grey Stock Ellistown 4933
STOCK

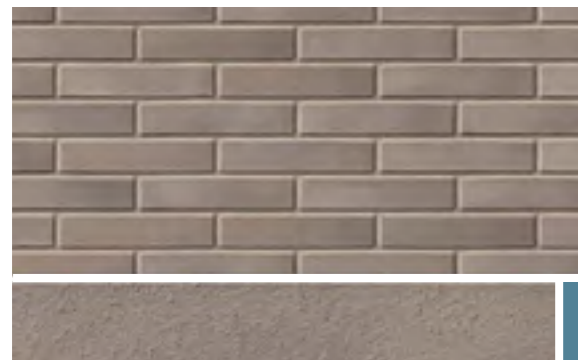

Clifton Clerkenwell A5163A
WIRECUT



CROWBOROUGH MULTICOLOURED STOCK:
FITZWILLIAM COLLEGE LIBRARY, CAMBRIDGE



Crowborough Multicoloured Stock Ashdown 4002
STOCK



Tenebris Leicester A0079A
STOCK



Leicester Grey Stock Ellistown 4978
STOCK



Bradgate Medium Grey Leicester 0032
STOCK

■ DRAGFACED ■ SANDCREASED ■ DISTRESSED ■ SANDFACED



Himley Ash Grey
WIRECUT Aldridge 0358



Tradesman Antique Grey
WIRECUT Chesterton 0314



Brunswick Tryfan Grey
WIRECUT Cattybrook 0642



Arden Grey
STOCK Ellistown 4979



Albus
STOCK Leicester A0090A



Tradesman Light
WIRECUT Chesterton 2693



HIMLEY ASH GREY BLUEBELL VIEWS, WARWICK UNIVERSITY

IMAGE: SILVER BLACK LINEAR,
UNIVERSITY OF BIRMINGHAM LIBRARY

LONG FORMAT BRICKS



Lewis
LONG FORMAT
Clerkenwell **NE5073A**



Lundy
LONG FORMAT
Clerkenwell **NE5079A**



Natural Blue Riven Textured Linear
LONG FORMAT
Lodge Lane **NA2207A**



Natural Blue Smooth Linear
LONG FORMAT
Lodge Lane **NA2206A**



Brown Waterstruck
LONG FORMAT
Birtley **NA2634A**



Barra
LONG FORMAT
Clerkenwell **NE5082A**



Parham Red Stock
LONG FORMAT
Laybrook **NA0708A**



Townhouse Blend
LONG FORMAT
Birtley **NA2623A**



NATURAL BLUE SMOOTH LINEAR:
SHEPHERDS VETS, BRIDGEND



NATURAL BLUE LINEAR: NATIONAL
HORIZONS CENTRE, DARLINGTON

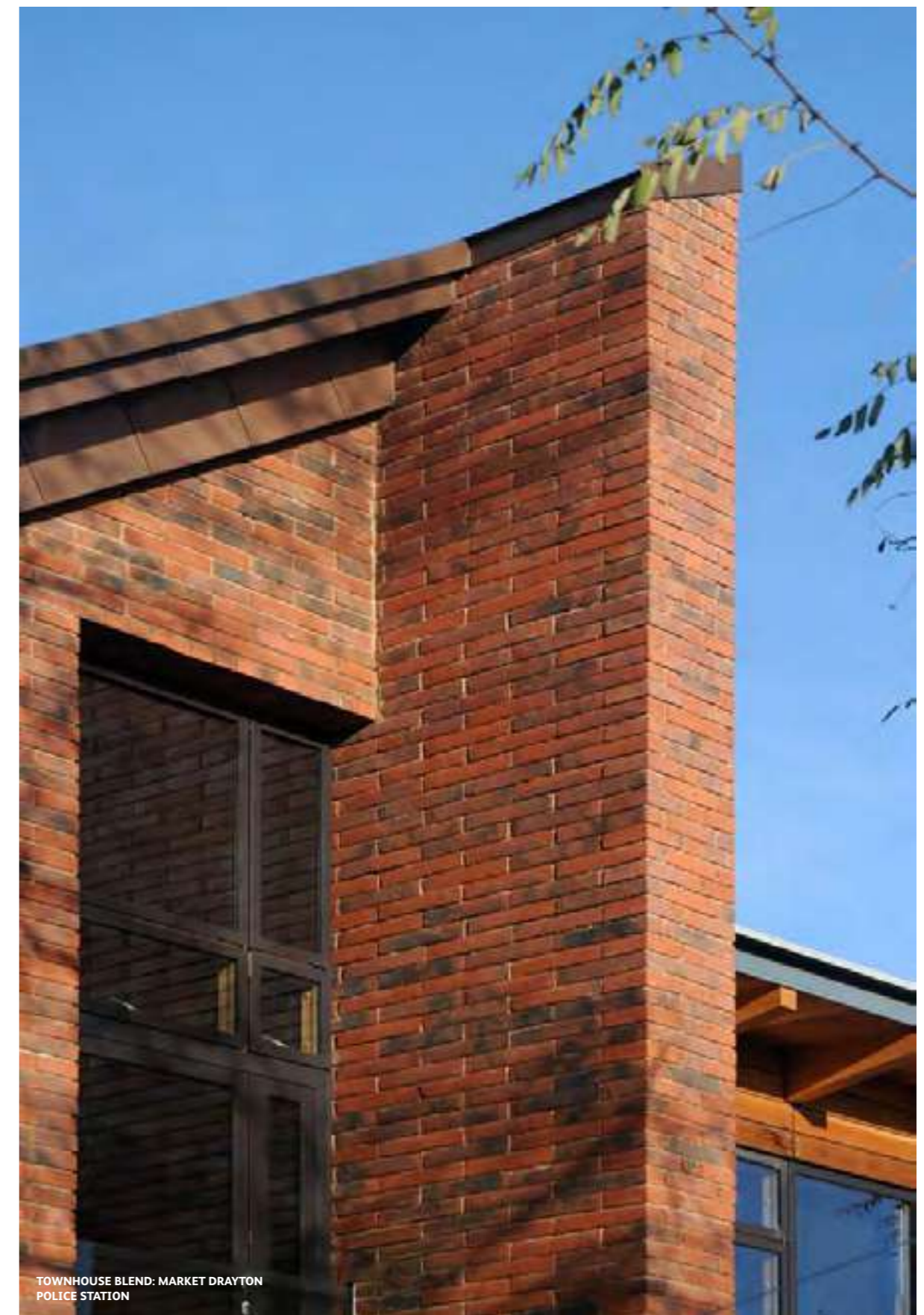

TOWNHOUSE BLEND: MARKET DRAYTON
POLICE STATION

■ DISTRESSED

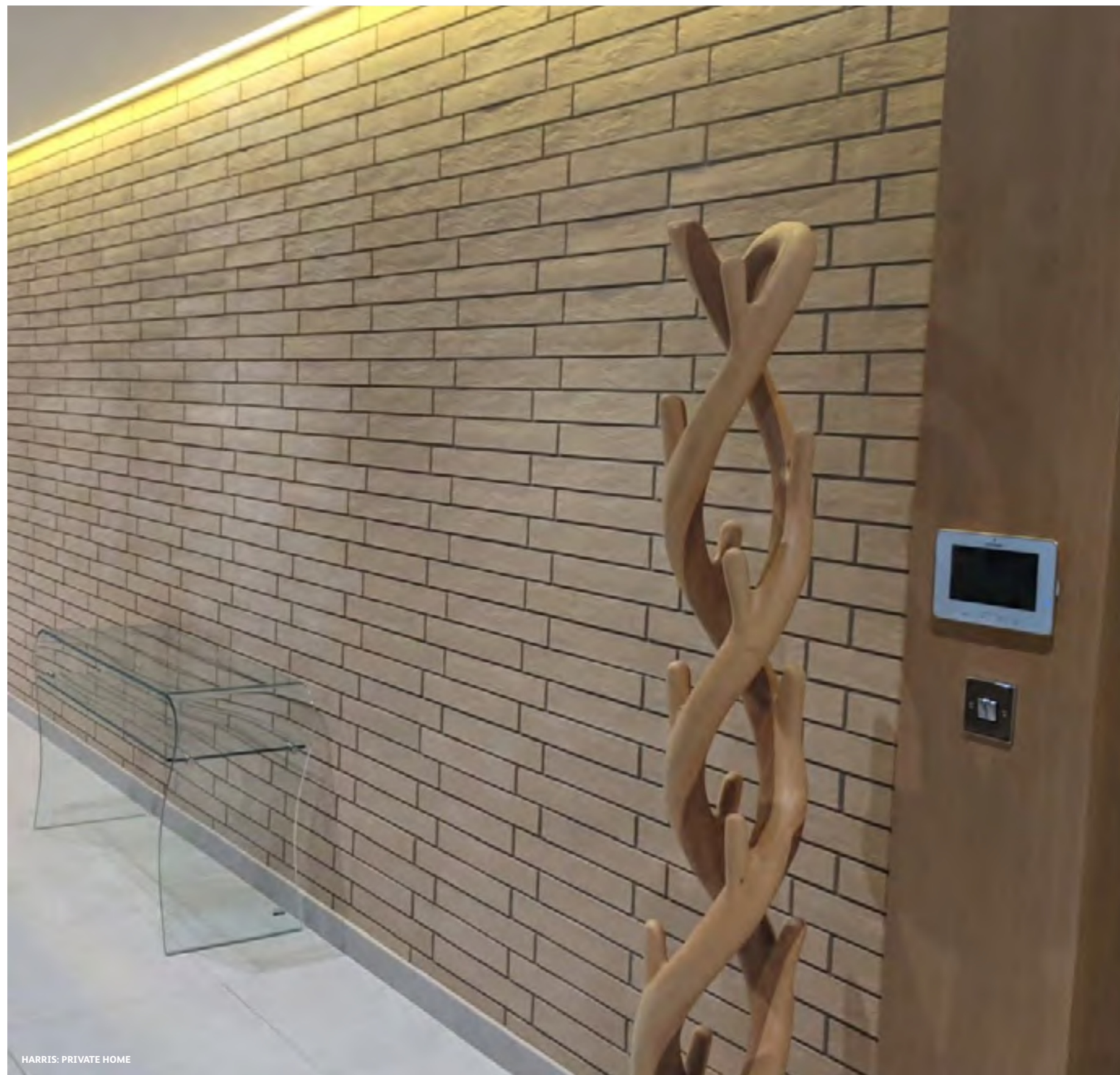

HARRIS: PRIVATE HOME



Olde English
LONG FORMAT Birtley **NA2602A**

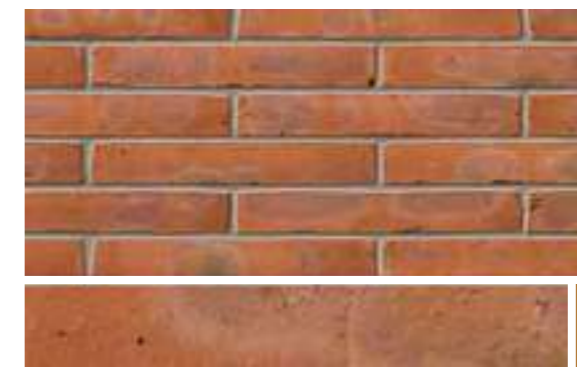

Commercial Red
LONG FORMAT Birtley **NA2611A**



Beamish Blend
LONG FORMAT Birtley **NA2601A**



Olde English Grey
LONG FORMAT Birtley **NB2640A**



Olde English Buff
LONG FORMAT Birtley **NF2605A**



Tresco
LONG FORMAT Clerkenwell **NE5081A**



Stronsay
LONG FORMAT Clerkenwell **NE5077A**



Samson
LONG FORMAT Clerkenwell **NE5078A**



Bryher
LONG FORMAT Clerkenwell **NJ5080A**



Harris
LONG FORMAT Clerkenwell **NH5076A**



Sanday
LONG FORMAT Clerkenwell **NE5072A**

IMAGE: BESPOKE BLUE GLAZED BRICKS,
BEAK STREET, LONDON

GLAZED BRICKS



White Glazed
WIRECUT Clerkenwell **WHITE**



London White Glazed
WIRECUT Clerkenwell **LONDONWHITE**



Cream Glazed
WIRECUT Clerkenwell **CREAM**



Light Grey Glazed
WIRECUT Clerkenwell **LIGHT GREY**



Yellow Glazed
WIRECUT Clerkenwell **YELLOW**



Lemon Glazed
WIRECUT Clerkenwell **LEMON**



Aqua Marine Glazed
WIRECUT Clerkenwell **AQUA MARINE**



Garland Glazed
WIRECUT Clerkenwell **GARLAND**



WHITE GLAZED: THE MUSIC BOX, LONDON



Lime Glazed
WIRECUT Clerkenwell **LIME**

BLEND OF BLUE GLAZED: THE CAMBRIDGE TRIANGLE BUILDING



Satin Sky Blue Glazed Wirecut Clerkenwell SATIN SKY BLUE

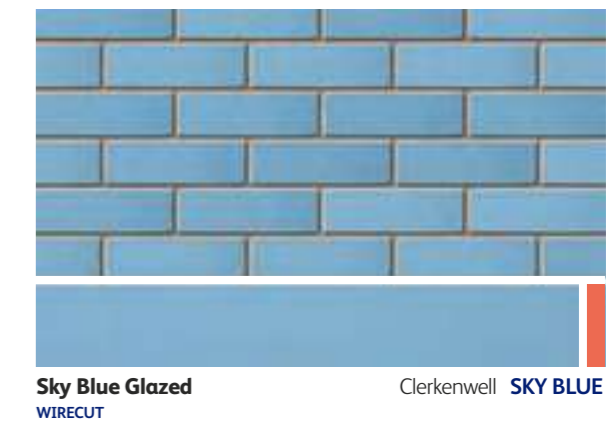

Sky Blue Glazed Wirecut Clerkenwell SKY BLUE

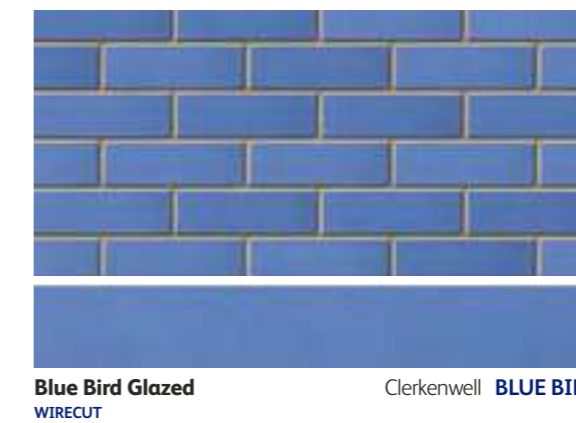

Blue Bird Glazed Wirecut Clerkenwell BLUE BIRD

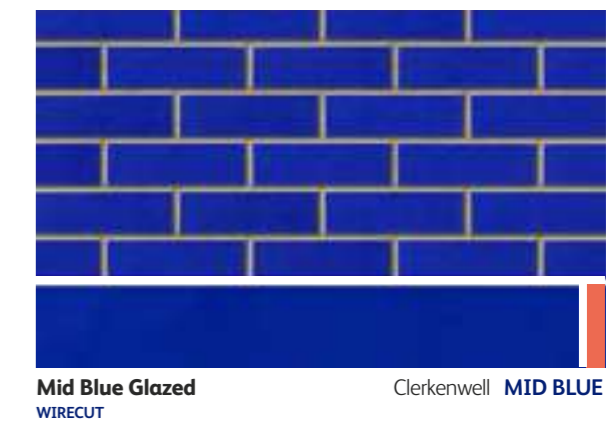

Mid Blue Glazed Wirecut Clerkenwell MID BLUE

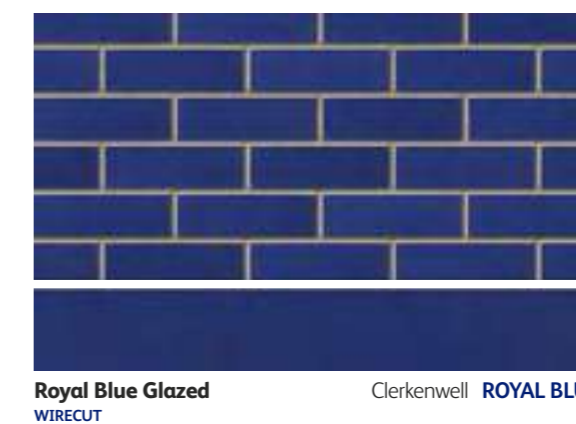

Royal Blue Glazed Wirecut Clerkenwell ROYAL BLUE

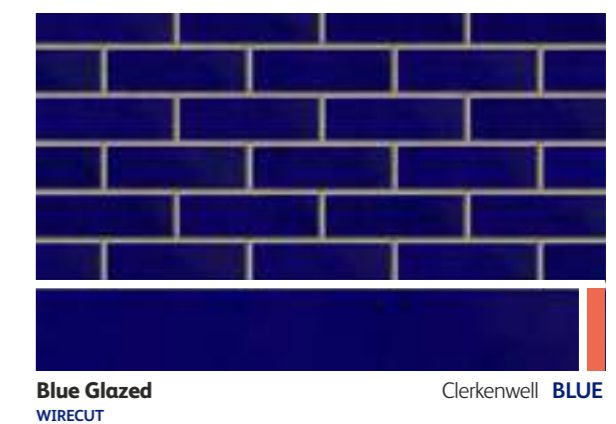

Blue Glazed Wirecut Clerkenwell BLUE



Iodine Glazed Wirecut Clerkenwell IODINE



Navy Blue Glazed Wirecut Clerkenwell NAVY BLUE



BUCKINGHAM



Mint Glazed Wirecut Clerkenwell MINT



Buckingham Glazed Wirecut Clerkenwell BUCKINGHAM



Copper Glazed Wirecut Clerkenwell COPPER



Bottle Green Glazed Wirecut Clerkenwell BOTTLE GREEN



Conifer Glazed Wirecut Clerkenwell CONIFER



Jade Glazed Wirecut Clerkenwell JADE

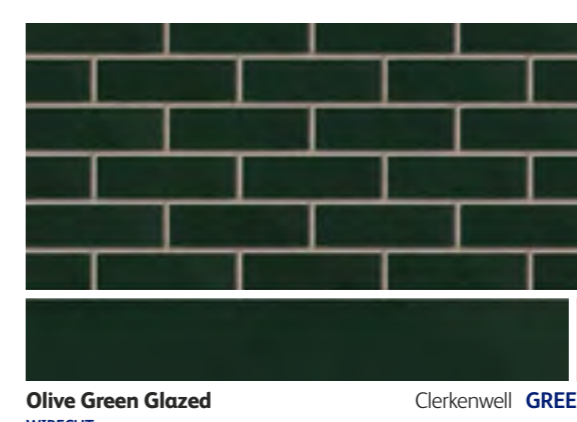

Olive Green Glazed Wirecut Clerkenwell GREEN



Dark Grey Glazed Wirecut Clerkenwell DARK GREY



Dark Salmon Glazed Wirecut Clerkenwell **DARK SALMON**



Burgundy Red Glazed Wirecut Clerkenwell **RED**



Plum Glazed Wirecut Clerkenwell **PLUM**

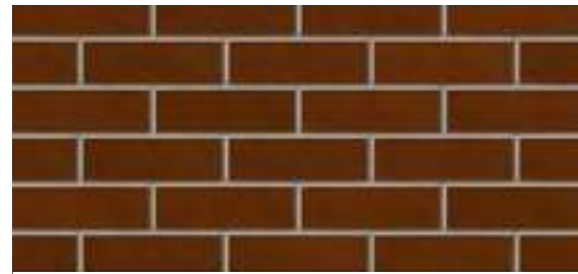

Toffee Glazed Wirecut Clerkenwell **TOFFEE**

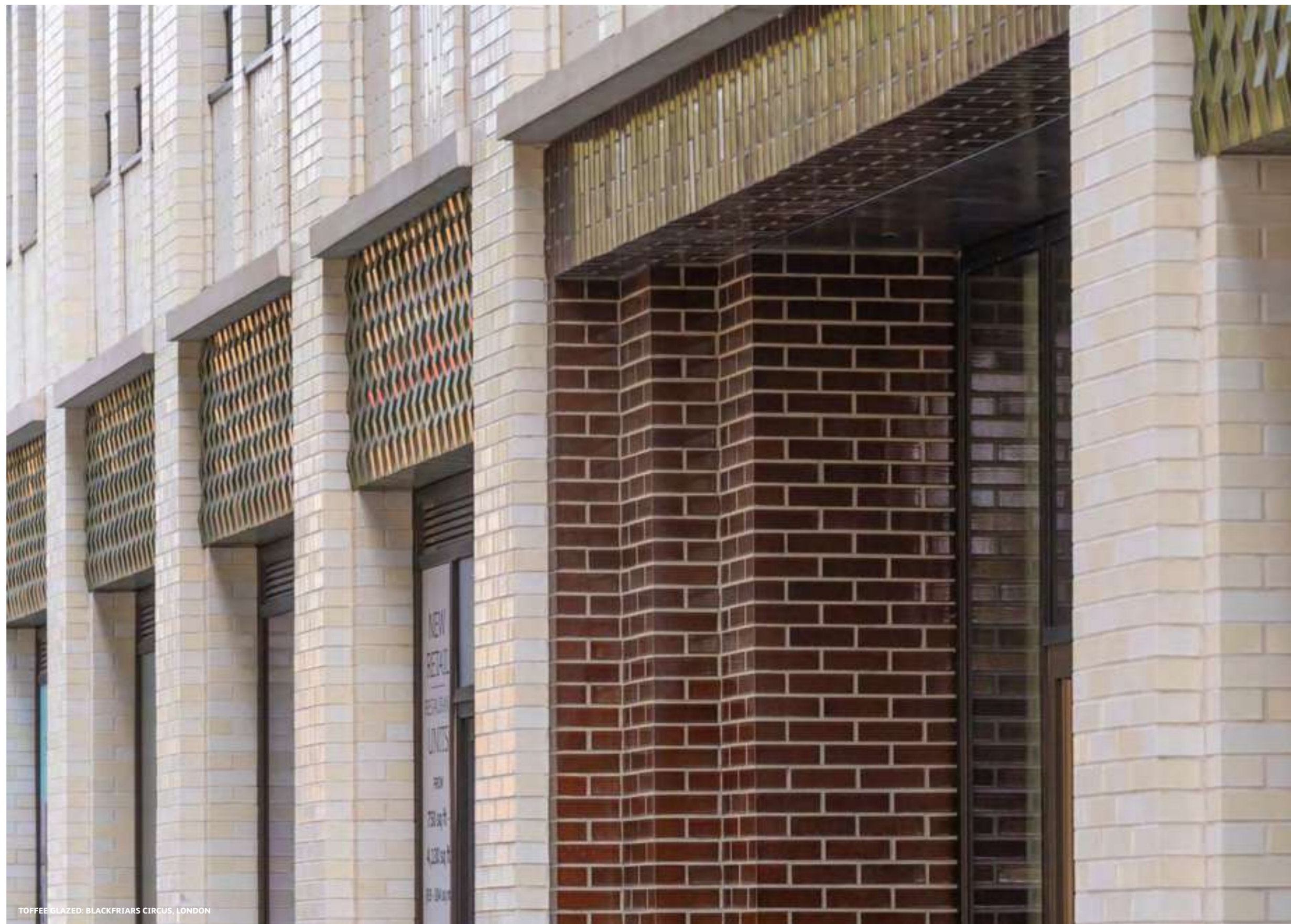

TOFFEE GLAZED: BLACKFRIARS CIRCUS, LONDON



Satin Grey Glazed Wirecut Clerkenwell **SATIN GREY**



Pewter Glazed Wirecut Clerkenwell **PEWTER**

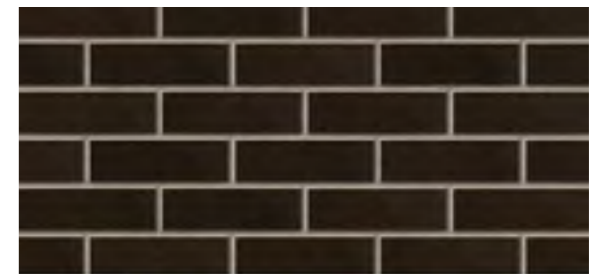

Conker Glazed Wirecut Clerkenwell **CONKER**



Black Glazed Wirecut Clerkenwell **BLACK**

IMAGE: LAYBROOK RED MULTI STOCK PAVER,
YHA, ITFORD FARM, BEDDINGHAM

PAVERS



Laybrook SUDS Red Multi Stock Paver PAVER Laybrook 0727



Laybrook Red Multi Stock Paver PAVER Laybrook 0727



Laybrook Flame Red Stock Paver PAVER Laybrook 0773



Laybrook SUDS Flame Red Stock Paver PAVER Laybrook 0773



Laybrook SUDS Multi Stock Paver PAVER Laybrook 0726



LAYBROOK RED MULTI STOCK PAVES: YHA, ITFORD FARM, BEDDINGHAM



TRADESMAN[®]

TRADITIONAL FINISHES FOR THE MODERN BUILDER

The UK's historic housing stock has been built with bricks made from distinctive Lower Oxfordshire Clay, and our Tradesman[®] Range has been meticulously designed to blend in with these bricks.

Made to exacting standards, the whole Tradesman Range is **rated F2** and therefore has a **superior durability**, along with a **high compressive strength** and **low water absorption**. This means they can be used with confidence in almost all settings and can handle the **harshest weather conditions**.

OFFERING SUPERIOR **DURABILITY AND STRENGTH**



A brick range that delivers a perfect match

Matching with extensions and refurbishments, along with new builds and boundary walls is made simple due to excellent consistency of both **colour** and **texture**, along with ease of laying, and **minimal waste**.





TRADESMAN®

WHY USE THE IBSTOCK BRICK TRADESMAN® RANGE?

1

Price



All products are competitively priced enabling our customers to compete on every project without compromising quality.

2

Durability



All products are rated F2, ensuring that they can be used in any application without fear of damage from extreme weather.

3

Range



Replicating traditional aesthetics, the Tradesman range provides high quality modern solutions for traditional builds.



TRADESMAN®

TRADITIONAL FINISHES FOR THE MODERN BUILDER

4

Mixed loads

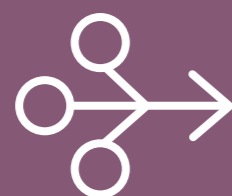

The Tradesman range can be conveniently mixed to make up a full load, making stocking easier for merchants with less yard space.

5

Product Consistency



Consistent colour, texture and quality, giving customers greater confidence in the long term, both for depot stock and sites.

6

Low breakages



With very few breakages across the entire Tradesman range, this saves our customers money with wasted products.



TRADESMAN®

TRADITIONAL FINISHES FOR THE MODERN BUILDER

7

Special shapes

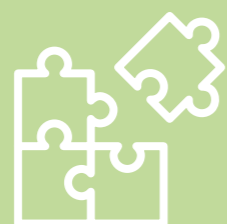

Ibstock Kevington's Cut & Bond service ensures customers can offer solutions where a non-standard brick type or size is required.

8

Support



Range supported by samples, literature and it's own website – customers have the support they need to promote the products.

9

Perforations

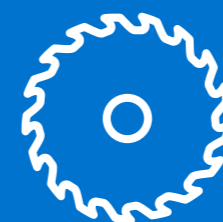

Product perforations make the product easier to lay and cut when required – ensuring projects can progress quickly.

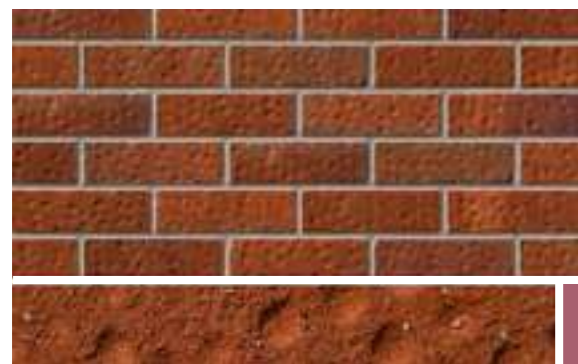

Tradesman Tudor Regent Cattybrook 0605
WIRECUT



Tradesman Heather Mixture* Chesterton 2949
WIRECUT



Tradesman Rustic Blend Cattybrook 0618
WIRECUT

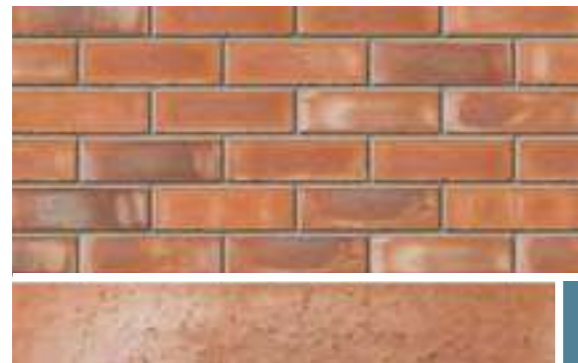

Tradesman Common Ravenhead 3598
WIRECUT



Tradesman Light Rustic Blend Ravenhead 3542
WIRECUT



Tradesman Buff Multi Cattybrook 0619
WIRECUT



Tradesman Millgate Buff Cattybrook 0620
WIRECUT



Tradesman Antique Grey Chesterton 0314
WIRECUT



Tradesman Light Chesterton 2693
WIRECUT



TRADESMAN SANDFACED RED MULTI: APARTMENTS, BYRON STREET, GLASGOW



TRADESMAN TUDOR REGENT



IMAGE: NATURAL BLUE RIVEN TEXTURED LINEAR BRICKS ON MECHSLIP, BLAKES HOTEL, LONDON

A close-up photograph of a brick chimney stack against a clear blue sky.

Faststack Chimneys

A photograph of a brick building facade featuring arched windows and decorative brickwork patterns.

Hyperlite Arches

A photograph showing a close-up of a brick surface with a small, dark, textured object, possibly a bird's nest or a piece of natural debris, set against a bright yellow background.

EcoHabitat Range

A photograph of a brick building facade with a grid of windows, showing a mix of brick and window patterns.

Nexus

A photograph of a brick building facade with a grid of windows, showing a mix of brick and window patterns.

MechSlip

KEVINGTON PRODUCTS

FASTSTACK CHIMNEYS

Ibstock's Faststack Chimneys offer a market leading, high performance, safe and beautiful alternative to traditionally constructed chimneys.

Ibstock Kevington was the first to gain **BBA Certification** for its brick-clad chimneys, giving you total confidence for in **excess of 25 years**.

ibstockbrick.co.uk/kevington

FASTSTACK CHIMNEYS TIME SAVING CHIMNEY BUILDING



Easy installation

- ✓ Can be used on timber frame buildings where traditionally constructed chimneys cannot
- ✓ Stainless steel lifting sockets and certified loops
- ✓ No descending stack to consume valuable room space



Design flexibility

- ✓ Available as both fully working or decorative chimneys
- ✓ Range of clay pots available
- ✓ Available in a wide range of finishes including brick, stone and render
- ✓ Bespoke options available
- ✓ Flashing styles including stepped can be accommodated



High quality

- ✓ Marine grade one piece GRP
- ✓ Fully waterproof sealed units
- ✓ Integrated flashing channel
- ✓ All fixings and high quality PU lead coloured sealant supplied



Approved by NHBC



Endorsed by BBA



Quality assured



We also offer a range of chimneys specifically for developers. [Click here for more information.](#)

FASTSTACK CHIMNEYS

GABLE END CHIMNEYS



Othello Gable End
550 x 440 x 965H



Aragon Gable End
777 x 552 x 965H



Hermia Gable End
890 x 777 x 965H



Silius Gable End
1002 x 777 x 965H



Shylock Gable End
1340 x 665 x 965H

MID RIDGE CHIMNEYS



Othello Mid Ridge
550 x 440 x 965H



Aragon Mid Ridge
777 x 552 x 965H



Hermia Mid Ridge
890 x 777 x 965H



Silius Mid Ridge
1002 x 777 x 965H



Shylock Mid Ridge
1340 x 665 x 965H

PARAPET CHIMNEYS



Othello Mid Ridge
550 x 440 x 965H



Aragon Mid Ridge
777 x 552 x 965H



Shylock Mid Ridge
1340 x 665 x 965H

HYPERLITE ARCHES

Ibstock's Hyperlite is a revolutionary, outstandingly light, arch system which allows quick and simple arch construction with minimal skills.

Arches are a **traditional feature** of brickwork over openings and can vary from the simple flat arch detail to the highly decorative.

ibstockbrick.co.uk/kevington

HYPERLITE ARCHES OUTSTANDINGLY LIGHT, REMARKABLY QUICK

CONSTRUCTED USING A HIGH TECH BACKING MATERIAL THIS SYSTEM ALSO INCORPORATES 20MM BRICK ARCH SLIPS WHICH ARE BONDED TO THE FACE TO FINISH. POINTED ON THE GROUND AND USED IN CONJUNCTION WITH A STANDARD STEEL CAVITY LINTEL.

They have a compressive strength in excess of 13.0N/mm². The Hyperlite arch can be produced in one piece to a maximum 2000mm span and can be sectionalised to any length. Maximum 20mm fair faced soffit.



Endorsed by BBA

High-tech

backing material construction for light weight, safety and durability



20mm

brick arch slips – bonded to the face to finish



13.0N/mm²

excess compressive strength



2000mm

maximum single span



HYPERLITE ARCHES

HYPERLITE FLAT GAUGED (NON STRUCTURAL)

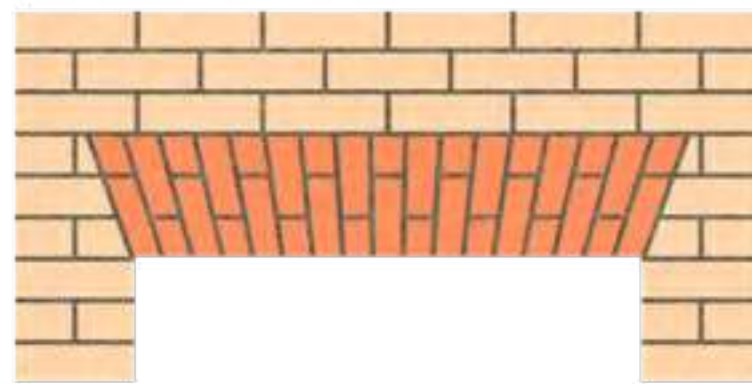

215mm High
Felbridge

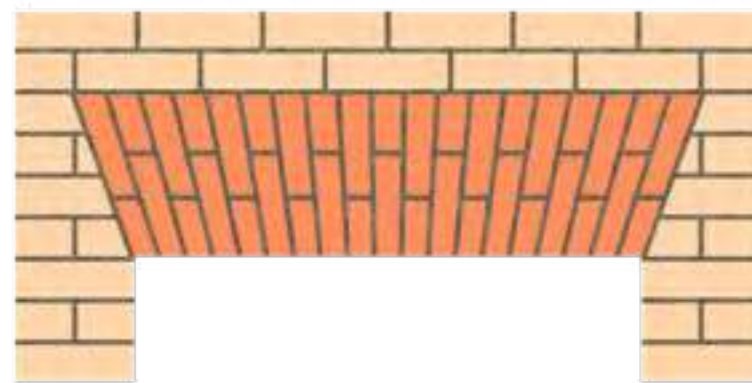

290mm High
Malvern

HYPERLITE SEGMENTAL ARCH STYLE INC RISER

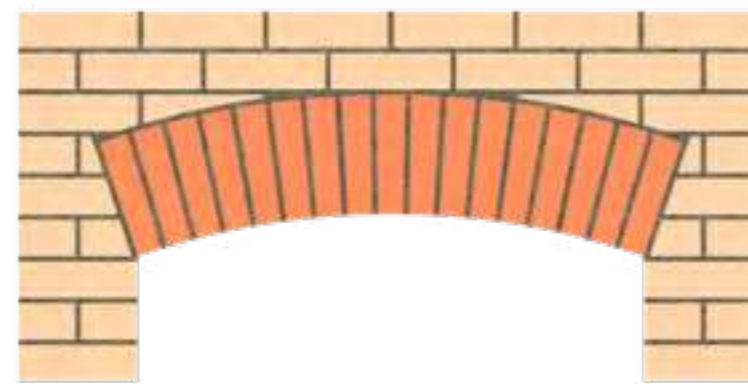

215mm High single unit
Melton

FASTWALL PANEL



Standard Panel
1115 x 590mm

ECOHABITAT RANGE

Our EcoHabitats help to encourage safe spaces for specific wildlife, allowing them to live in harmony with people.

We are passionate about supporting increased biodiversity wherever our products are used. Our range of EcoHabitat products are a great complement to any project, and can help satisfy **Special Environmental Needs** – now commonly a requirement of the planning process.



SWIFTS



VISUAL MATCH
Red, Buff or Blue

LOW MAINTENANCE
Built to last the life of the wall

SAFE
Homeowner and wildlife are safely separated

EASY
Installs like a brick

SWALLOWS & STARLINGS



VISUAL MATCH
Red, Buff or Blue

LOW MAINTENANCE
Built to last the life of the wall

SAFE
Homeowner and wildlife are safely separated

EASY
Installs like a brick

BEEES



VISUAL MATCH
All brick types

LOW MAINTENANCE
Built to last the life of the wall

SAFE
Homeowner and wildlife are safely separated

EASY
Installs like a brick

BATS

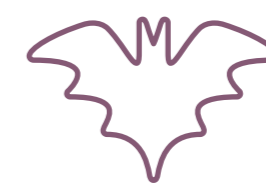

VISUAL MATCH
All brick types

LOW MAINTENANCE
Built to last the life of the wall

SAFE
Homeowner and wildlife are safely separated

EASY
Installs like a brick

HEDGEHOGS



VISUAL MATCH
Looks like a standard gravel board

PROTECTS
Fence from damp and rot

EASY
Installs like a standard gravel board

ROBUST
Concrete construction with steel inserts

NEXUS®

The perfect blend of design flexibility, aesthetic appeal, ease of installation and fire safety for all building heights.

The BBA approved family of NEXUS brick-faced soffit and lintel systems is a next **generation solution** that brings together a high integrity steel Ancon support system with engineered brick-faced units from Ibstock Kevington.

ibstockbrick.co.uk/kevington/nexus

NEXUS® UNBEATABLE INNOVATION



Mechanical fix system for additional peace of mind



Enhancement of established Nexus range



'A2' fire rated ensures highest resistance to fire



BBA approved for all building heights

x2



Both soffits and lintels available

£



Easy and cost effective installation

Free technical advice and design service is available,
e: nexus@ibstock.co.uk

IMAGE: SEVENOAKS YELLOW STOCK BRICK SLIPS
ON MECHSLIP, 30 STATION ROAD, CAMBRIDGE

MECHSLIP

Mechslip is the leading-edge brick cladding system. It is the most comprehensively tested and certified non-combustible rainscreen cladding system of its kind.

Launched in 2018, MechSlip was designed with performance and safety built in. It is already proven in projects around the UK with **more than 100,000m²** already specified. What's more, MechSlip brings you the freedom to design beautiful architecture with over 300 colours and textures to choose from.

www.mechslip.co.uk



BBA approved
for all building
heights



A1 Fire Rated



NHBC accepted

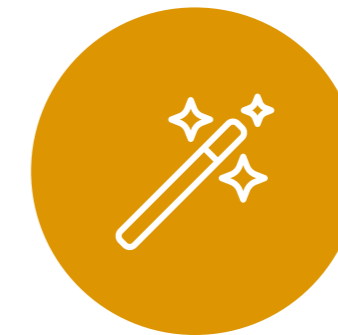

Design excellence
built in



Design advice
and practical
support

IMAGE: A BLEND OF SWANAGE HANDMADE BRICKS, KIMCOTE HALL, LUTTERWORTH

EVERYDAY SPECIAL SHAPED BRICKS

We view special shapes and fittings as those simple design elements that make good brickwork a masterpiece.

The Everyday Range includes all of the most **popular special shapes** and fittings now readily available. To help you further we have a dedicated team of experienced sales co-ordinators.

ibstockbrick.co.uk/kevington

BUILD SOMETHING **SPECIAL**

BS 4729

Compliant and compatible



Frost resistant

Guaranteed frost resistant to suit most brickwork applications



No cutting required

Specially designed for the job, no cutting is required



Specially made as standard

Special bricks, in stock



BN.10.2 Bullnose External Return On Edge

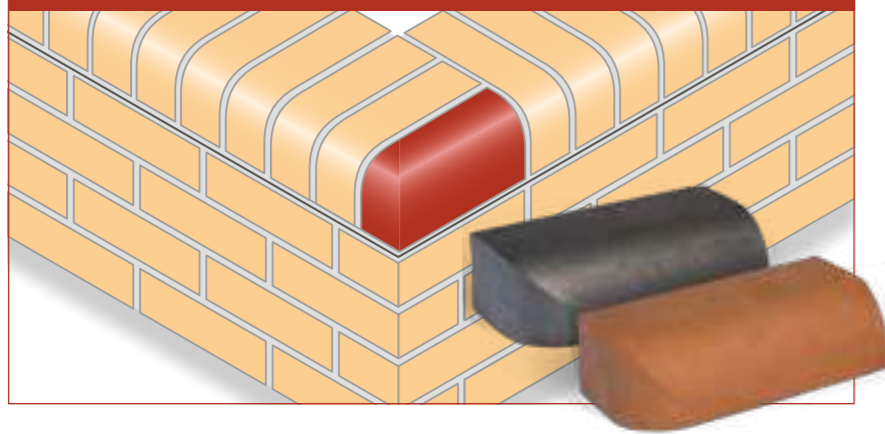

AN.6.2 Double Cant

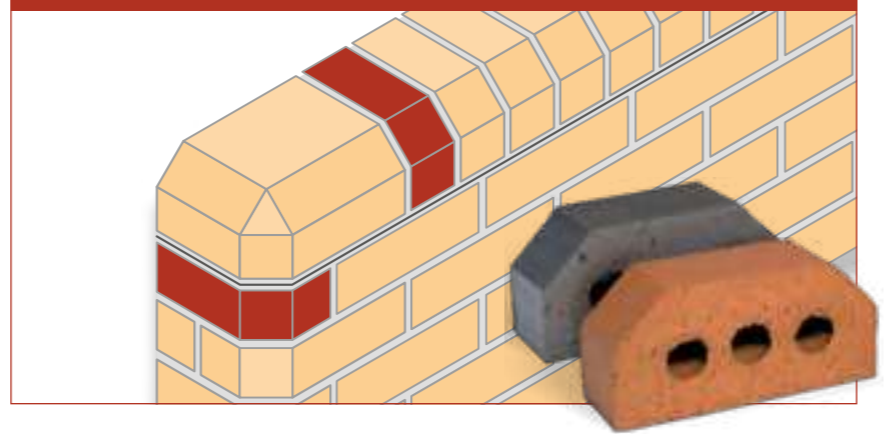

BN.2.2 Double Bullnose

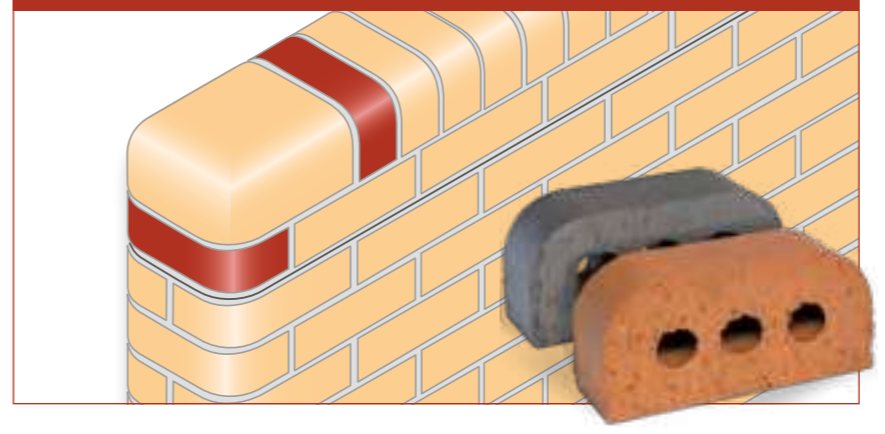

BN.1.2 Single Bullnose

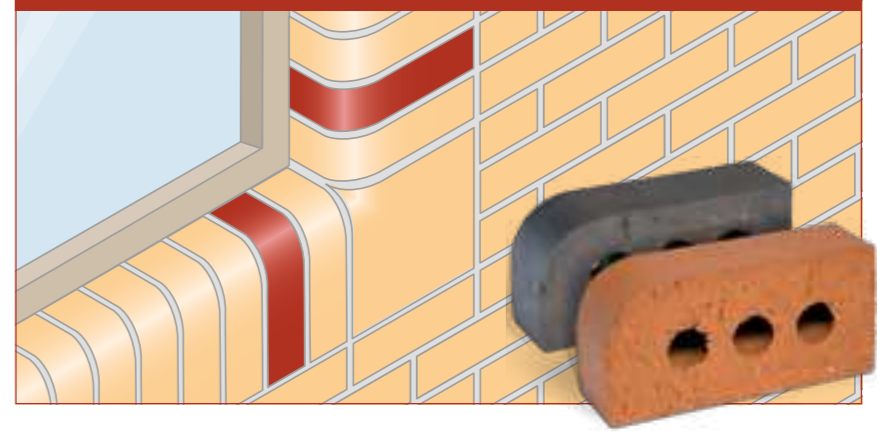

PL.7.1/PL.7.2 Plinth External Return

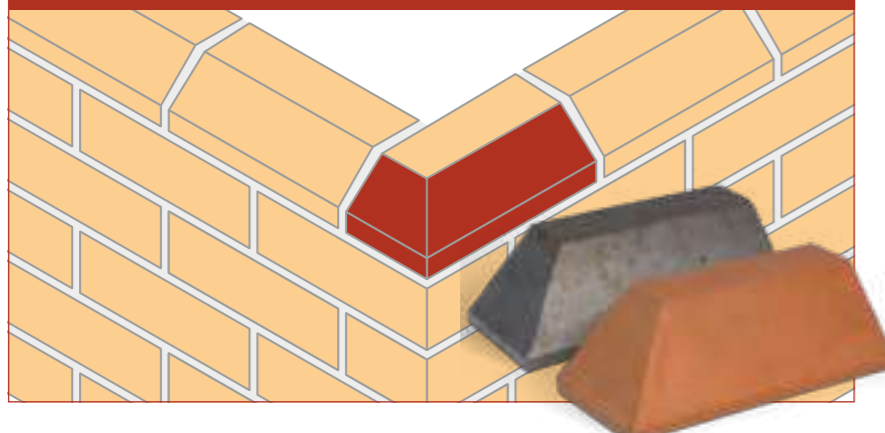

AN.1.2 45° Squint Brick



PL.4.1/PL.4.2 Plinth Internal Return

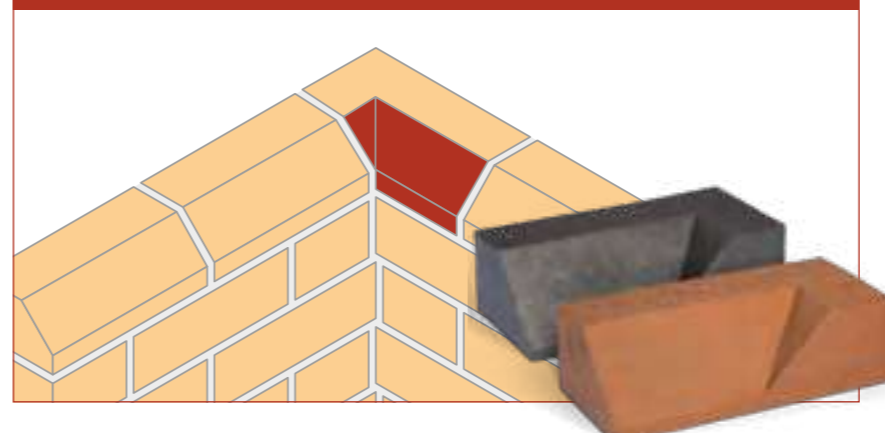

PL.3.1/PL.3.2 Plinth Stretcher

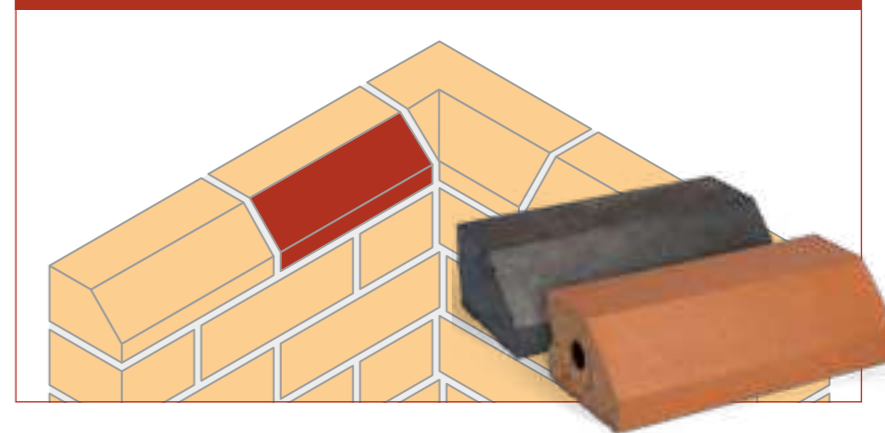

PL.2.1/PL.2.2 Plinth Header

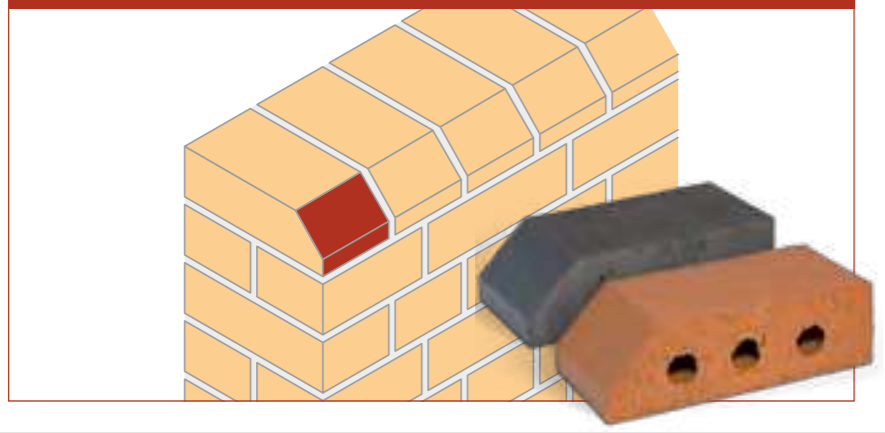

AN.5.2 Single Cant



S.SOLID Solid

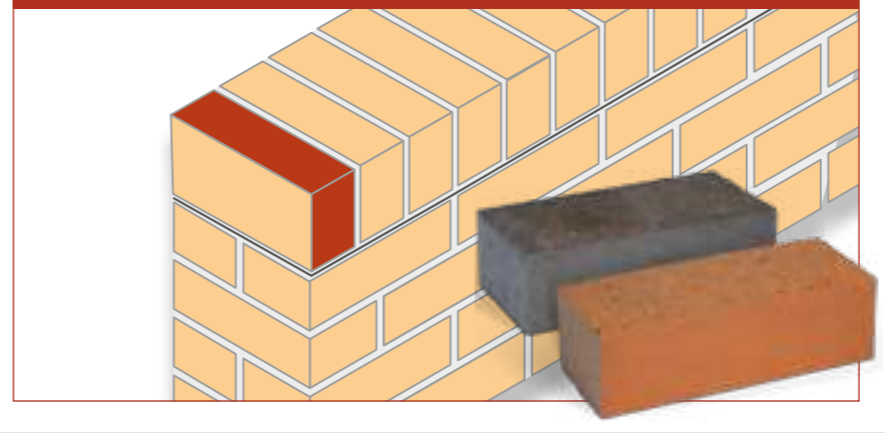

Great brickwork
made easy

ibstockbrick.co.uk/kevington



BULLNOSE BRICKS

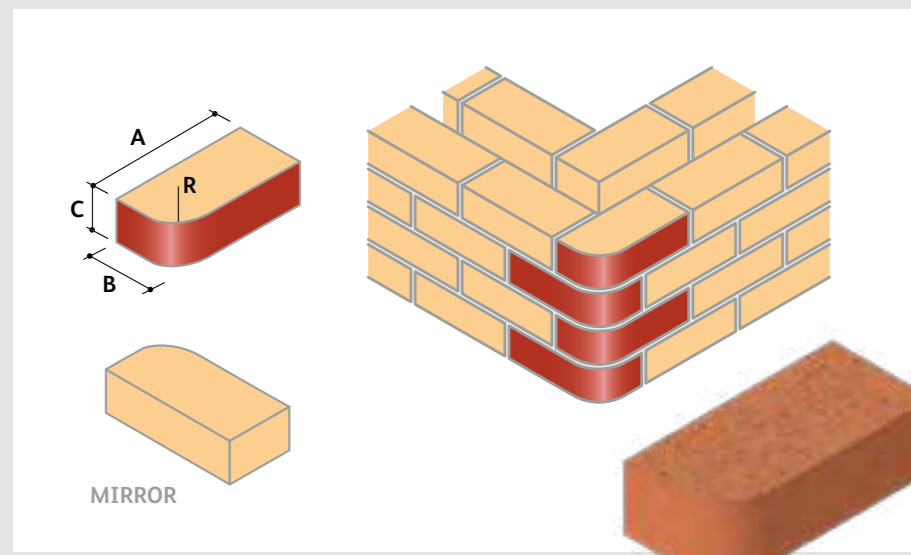

BN.1 Single Bullnose (Left & Right Hand)

TYPE NO.	A	B	C	R
BN.1.1	215	102	65	25
BN.1.2*	215	102	65	51

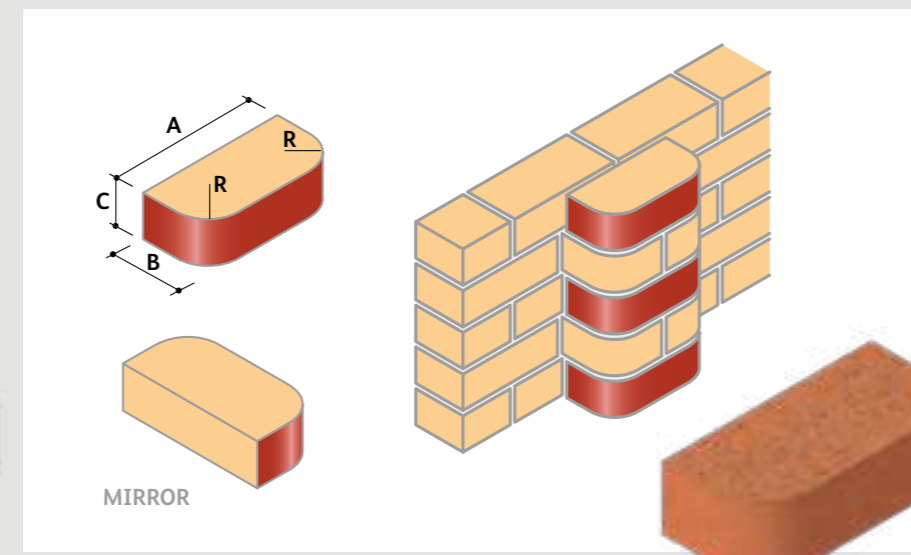

BN.2 Double Bullnose

TYPE NO.	A	B	C	R
BN.2.1	215	102	65	25
BN.2.2*	215	102	65	51

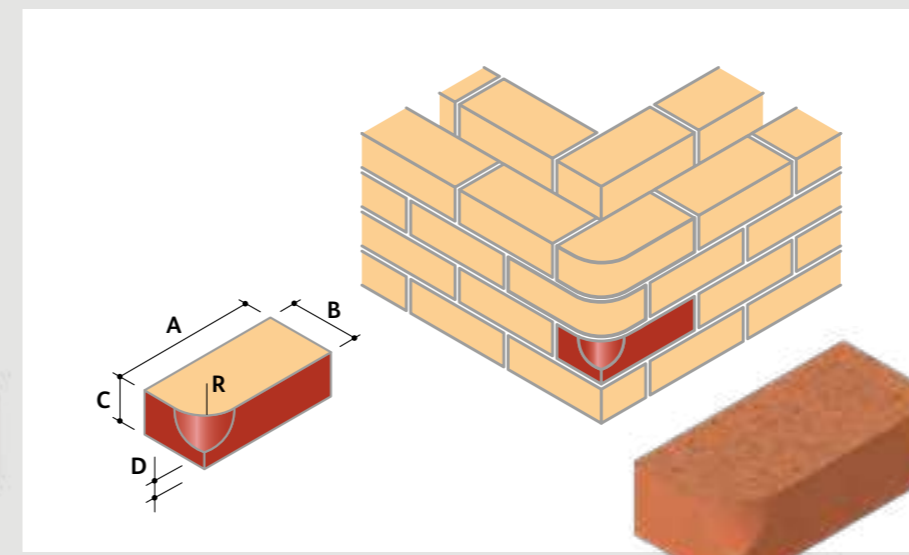

BN.3 Single Bullnose Stop (Left & Right Hand)

TYPE NO.	A	B	C	D	R
BN.3.1	215	102	65	25	25
BN.3.2	215	102	65	25	51

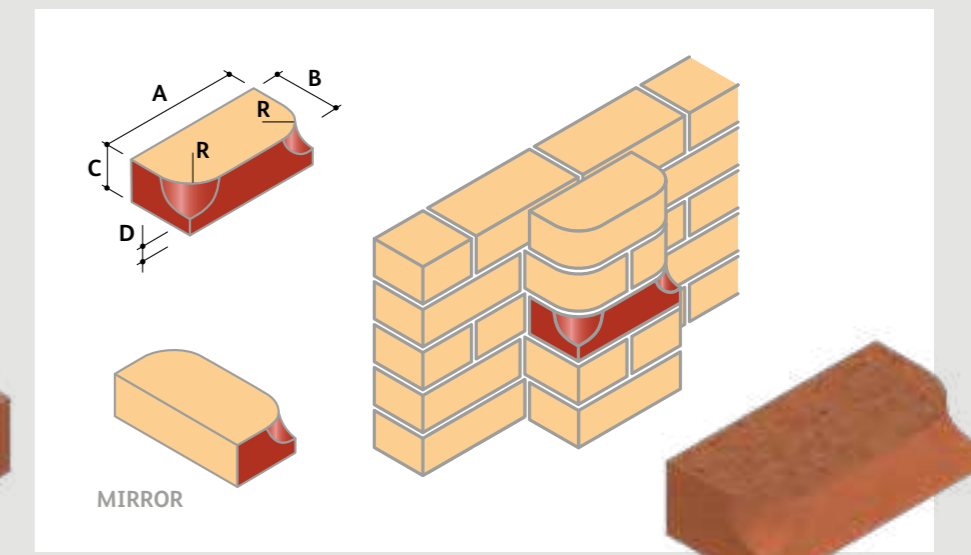

BN.4 Double Bullnose Stop

TYPE NO.	A	B	C	D	R
BN.4.1	215	102	65	25	25
BN.4.2	215	102	65	25	51

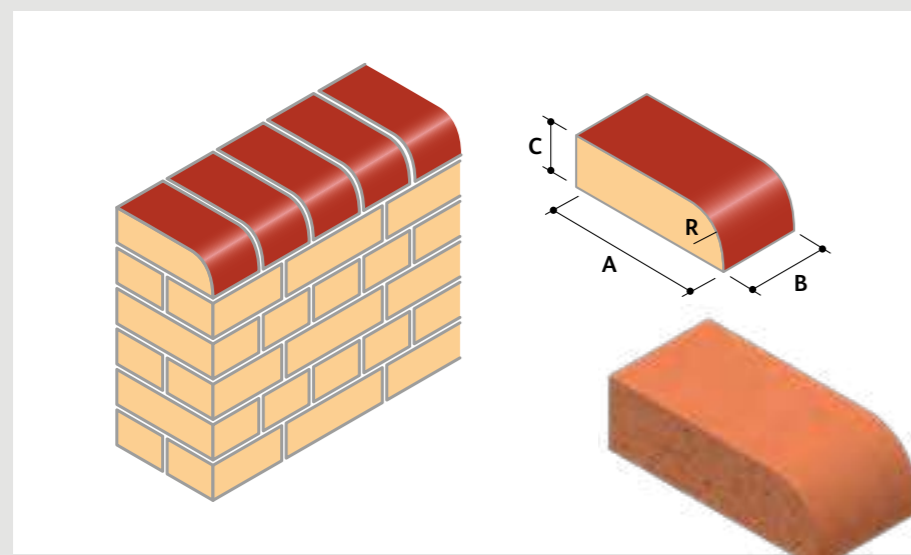

BN.5 Single Bullnose Header On Flat

TYPE NO.	A	B	C	R
BN.5.1	215	102	65	25
BN.5.2	215	102	65	51

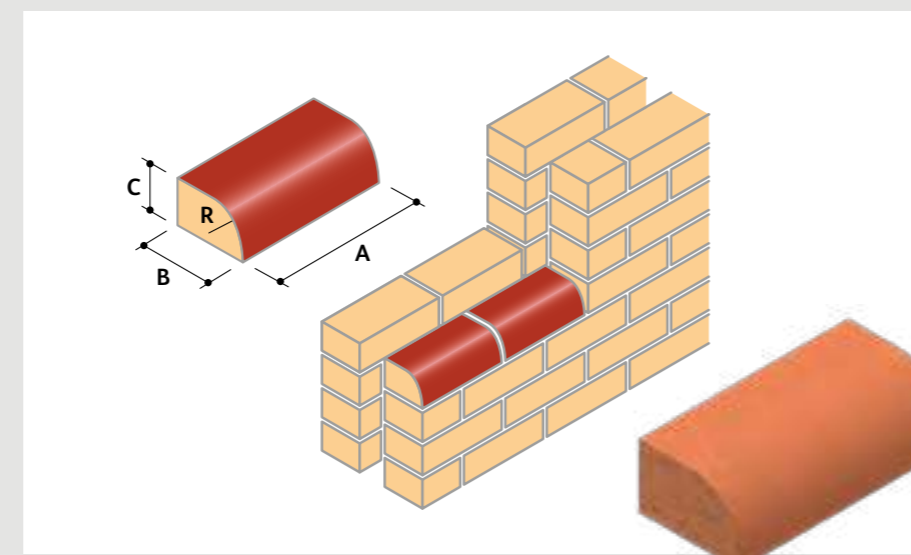

BN.6 Single Bullnose Stretcher On Flat

TYPE NO.	A	B	C	R
BN.6.1	215	102	65	25
BN.6.2	215	102	65	51

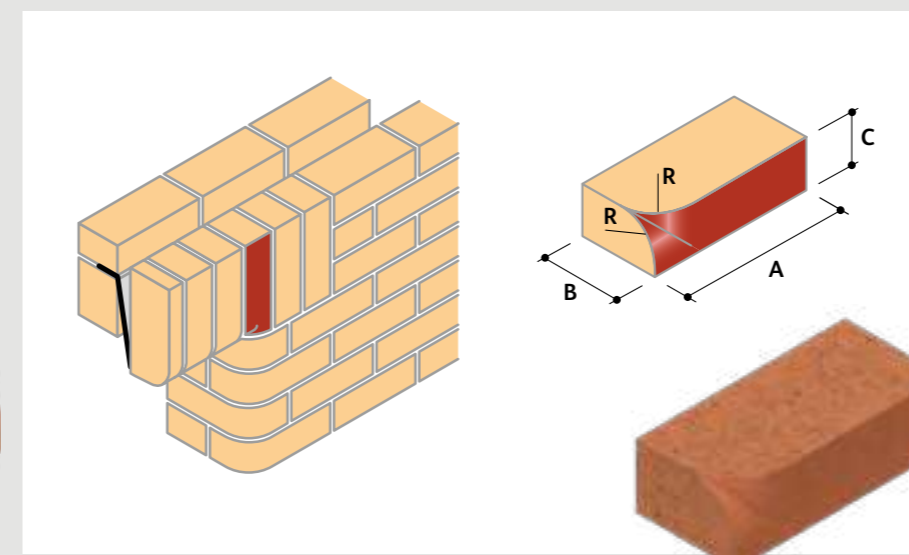

BN.7 Single Bullnose Internal Return Stretcher Faced (Left & Right Hand)

TYPE NO.	A	B	C	R
BN.7.1	215	102	65	25
BN.7.2	215	102	65	51
BN.7.3	215	102	215	25
BN.7.4	215	102	215	51

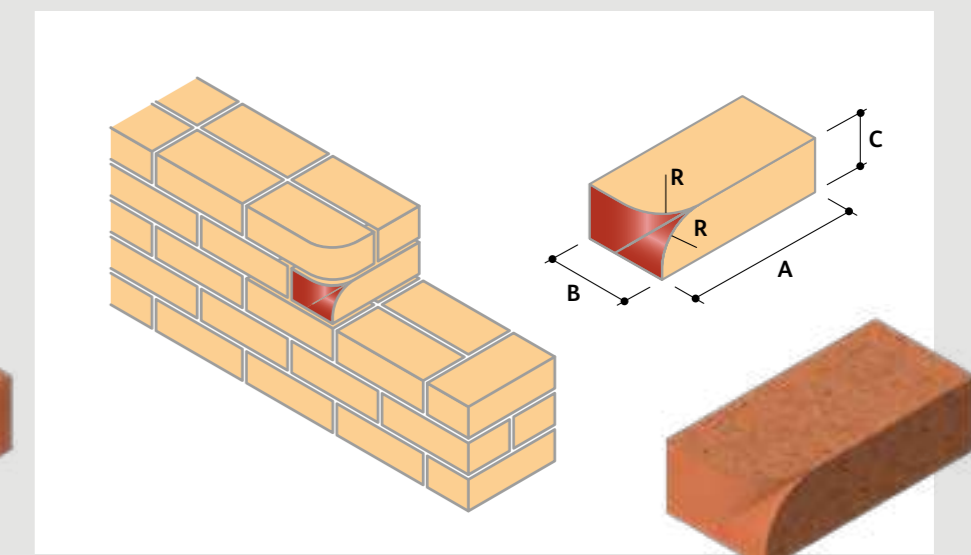

BN.8 Single Bullnose Internal Return Header Faced (Left & Right Hand)

TYPE NO.	A	B	C	R
BN.8.1	215	102	65	25
BN.8.2	215	102	65	51
BN.8.3	215	102	102	25
BN.8.4	215	102	102	51

* To complement the Everyday Range, Ibstock Kevington provides the perfect design details to finish off corners.

BULLNOSE BRICKS

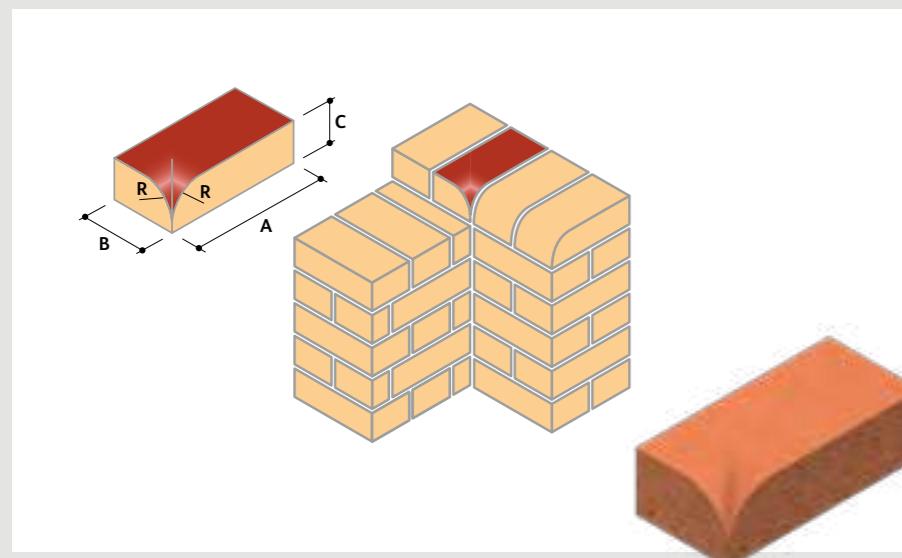

BN.9 Single Bullnose Internal Return Flat Faced (Left & Right Hand)

TYPE NO.	A	B	C	R
BN.9.1	215	102	65	25
BN.9.2	215	102	65	51

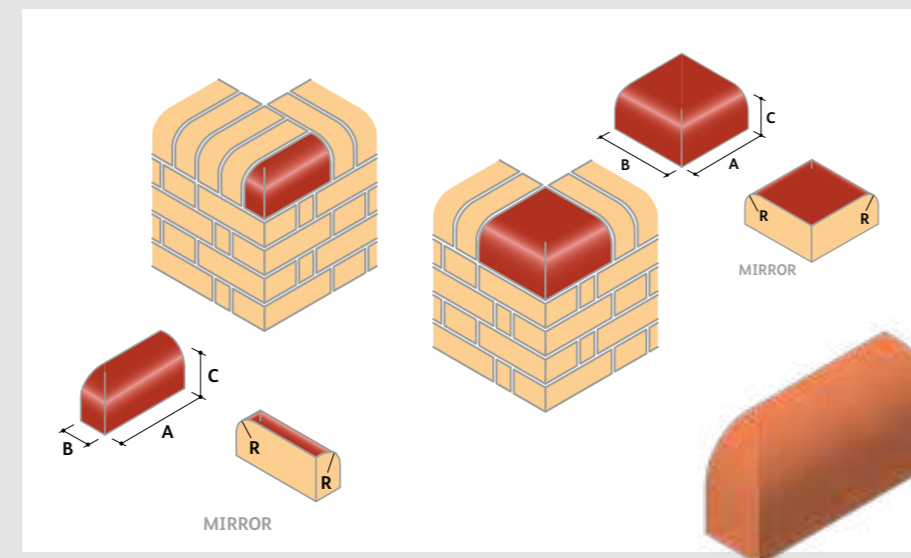

BN.10 Bullnose External Return On Edge (Left & Right Hand)

TYPE NO.	A	B	C	R
BN.10.1	215	65	102	25
BN.10.2 *	215	65	102	51
BN.10.3 ⓘ	215	215	102	25
BN.10.4 ⓘ	215	215	102	51

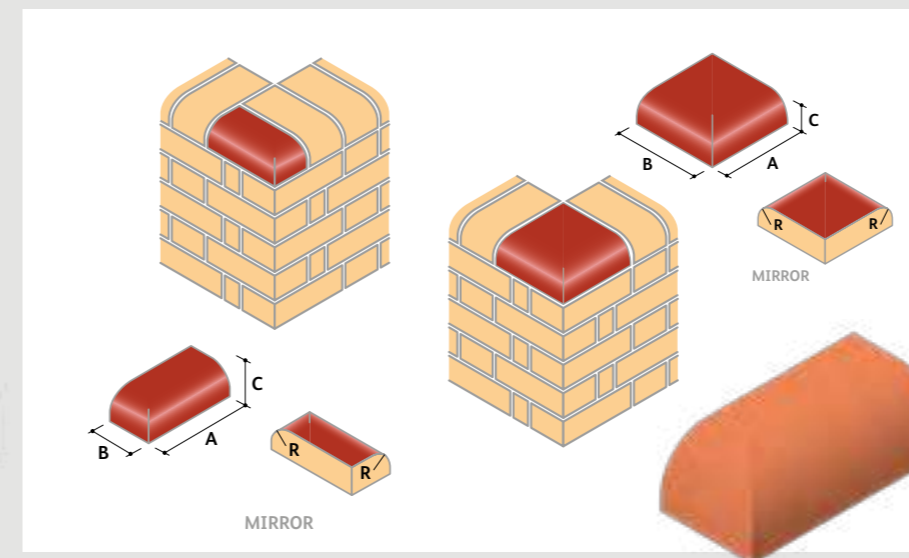

BN.11 Bullnose External Return On Flat (Left & Right Hand)

TYPE NO.	A	B	C	R
BN.11.1	215	102	65	25
BN.11.2	215	102	65	51
BN.11.3	215	215	65	25
BN.11.4	215	215	65	51

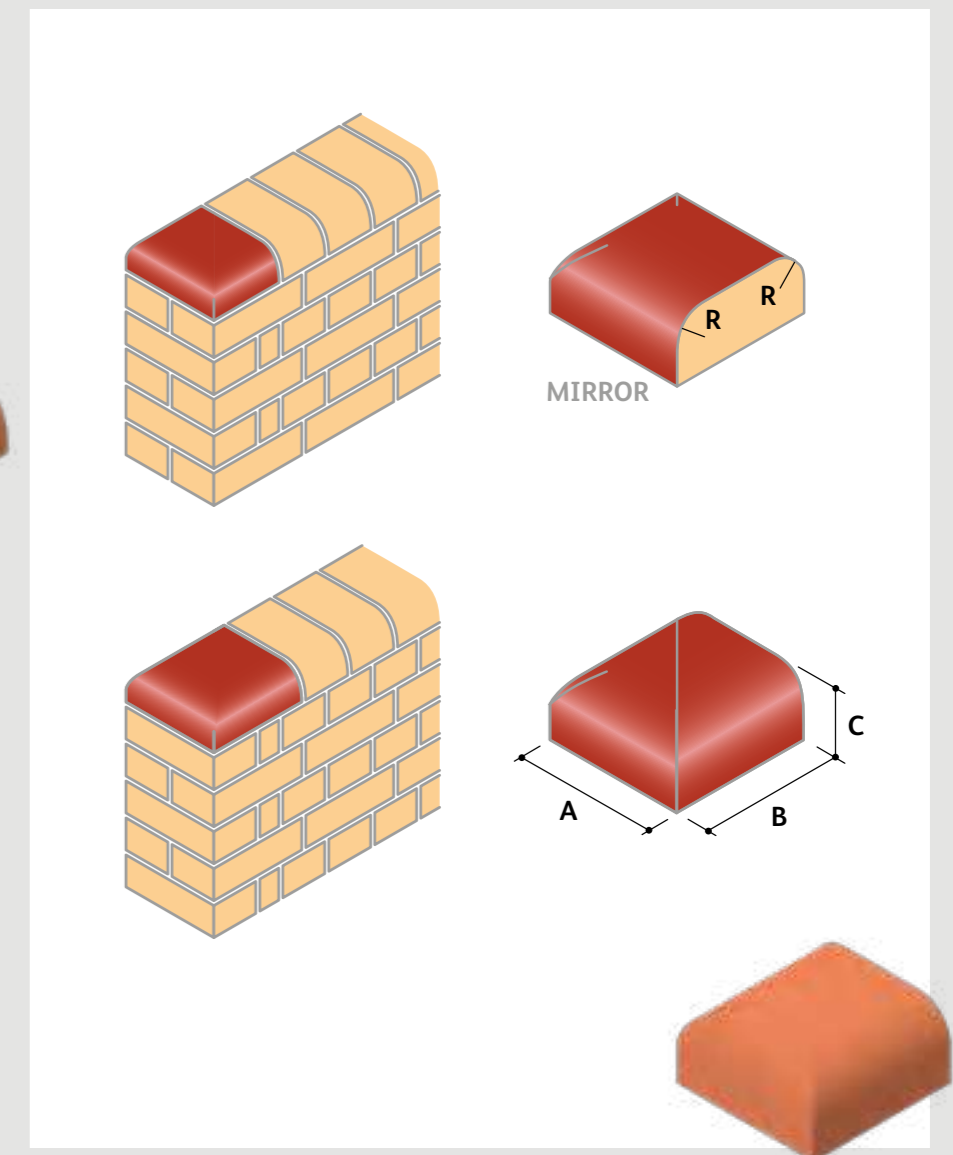

BN.15 Stop End to Double Bullnose On Edge and to Bullnose Double Header On Flat (Square Corners On Bed)

TYPE NO.	A	B	C	R
BN.15.1	215	159	102	25
BN.15.2 ●	215	159	102	51
BN.15.3 ●	215	215	102	25
BN.15.4	215	215	102	51
BN.15.5	215	159	65	25
BN.15.6	215	159	65	51
BN.15.7	215	215	65	25
BN.15.8	215	215	65	51

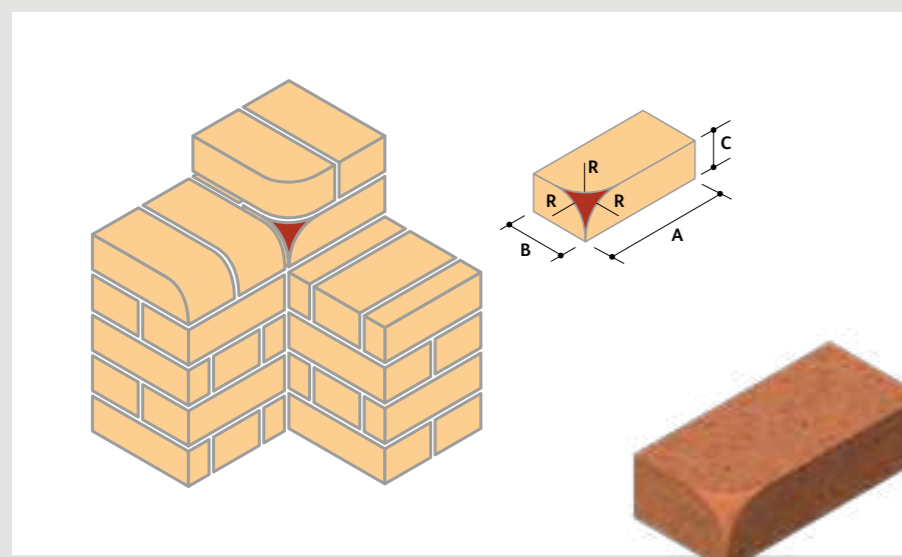

BN.12 Bullnose Mitre (Left & Right Hand)

TYPE NO.	A	B	C	R
BN.12.1	215	102	65	25
BN.12.2	215	102	65	51

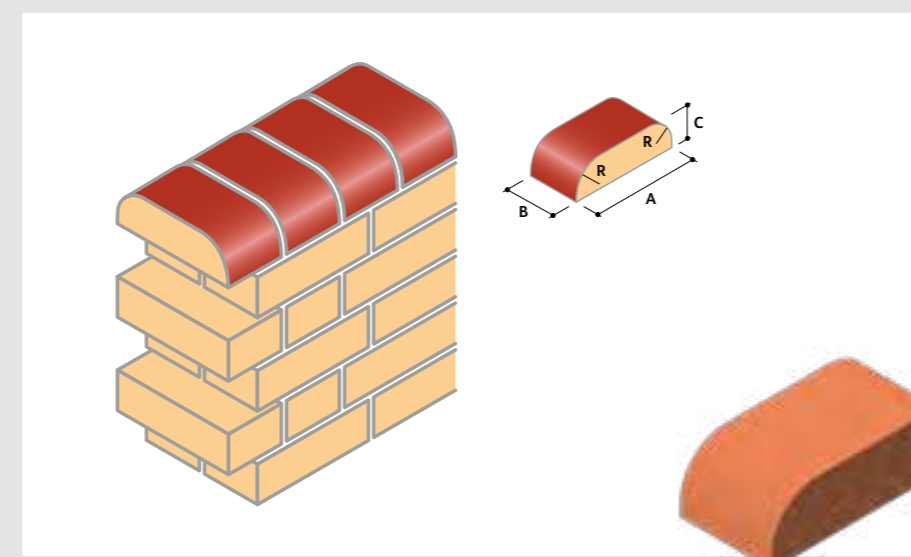

BN.13 Bullnose Double Header On Flat

TYPE NO.	A	B	C	R
BN.13.1	215	102	65	25
BN.13.2	215	102	65	51

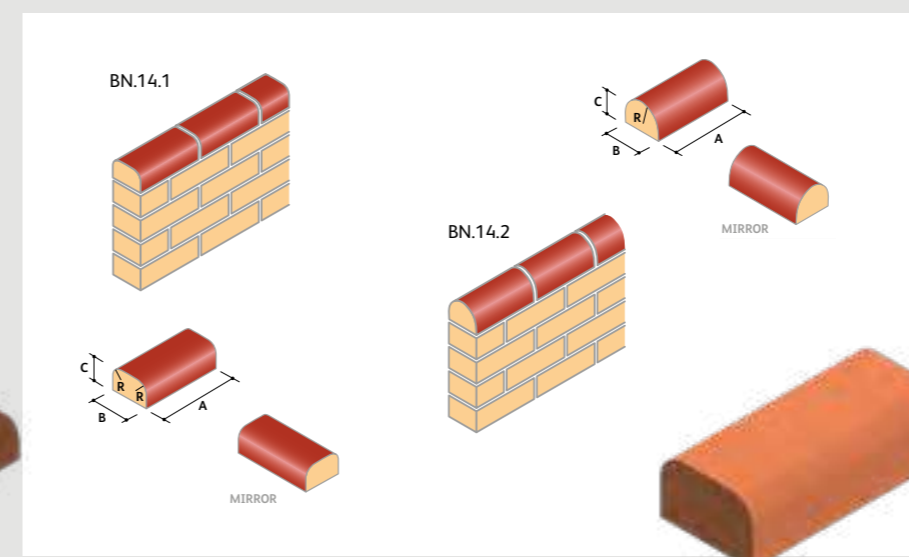

BN.14 Bullnose Double Stretcher On Flat

TYPE NO.	A	B	C	R
BN.14.1	215	102	65	25
BN.14.2	215	102	65	51

BULLNOSE BRICKS

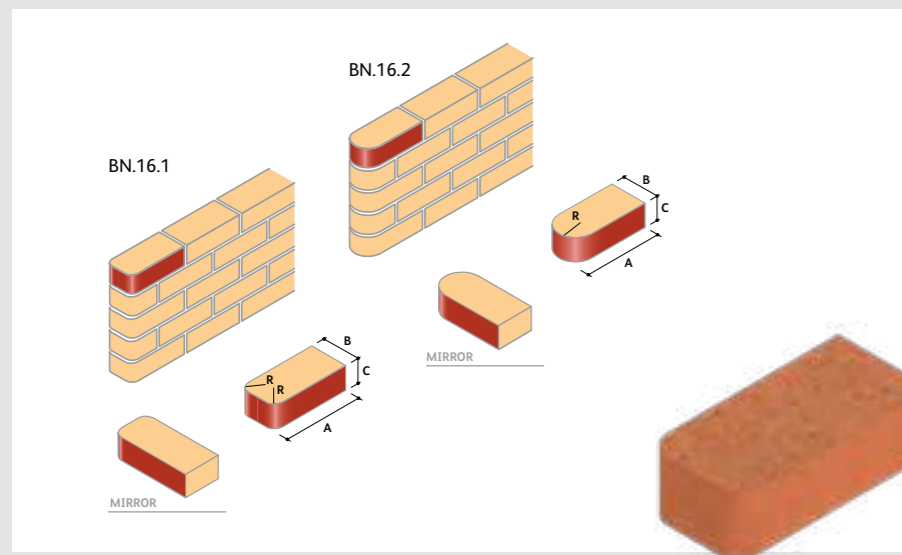

BN.16 Cownose

TYPE NO.	A	B	C	R
BN.16.1	215	102	65	25
BN.16.2	215	102	65	51

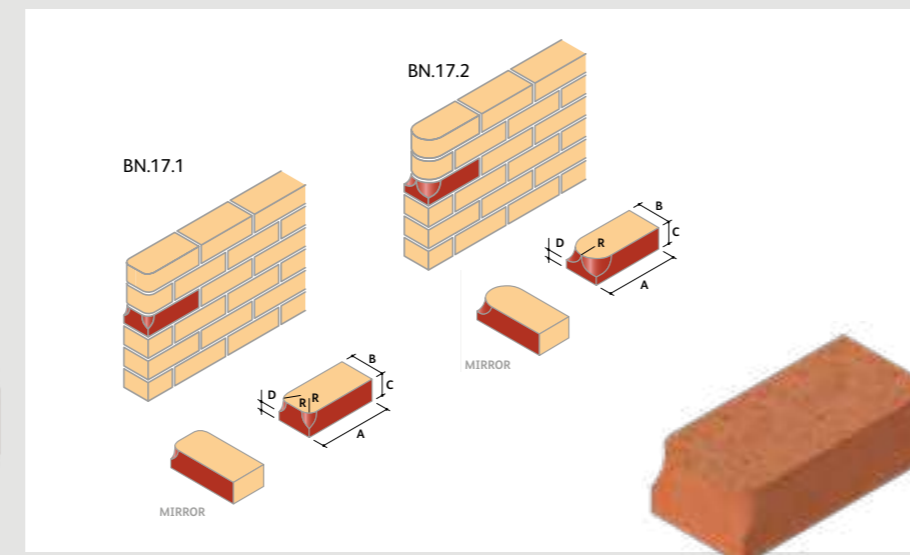

BN.17 Cownose Stop

TYPE NO.	A	B	C	D	R
BN.17.1	215	102	65	25	25
BN.17.2	215	102	65	25	51

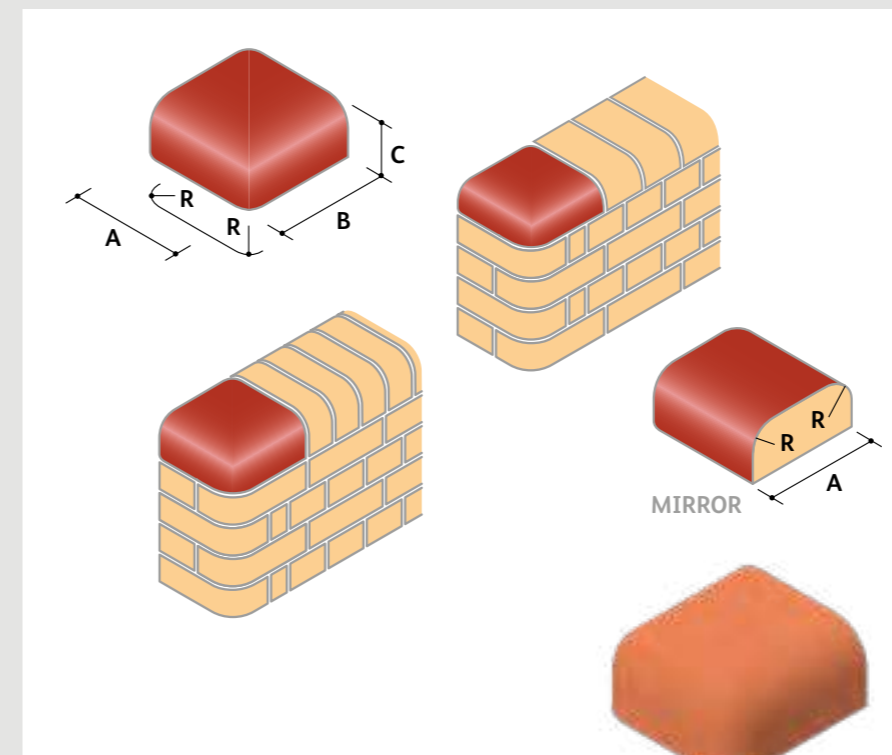

BN.18 Stop End to Double Bullnose On Edge and to Bullnose Double Header On Flat (Rounded Corners On Bed)

TYPE NO.	A	B	C	R
BN.18.1	215	159	102	25
BN.18.2	215	159	102	51
BN.18.3	215	215	102	25
BN.18.4	215	215	102	51
BN.18.5	215	159	65	25
BN.18.6	215	159	65	51
BN.18.7	215	215	65	25
BN.18.8	215	215	65	51

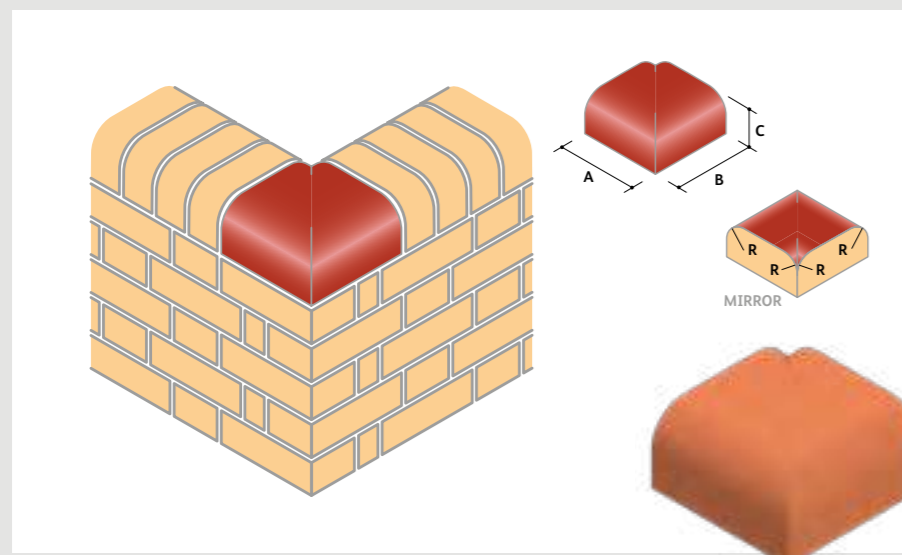

BN.19 External Return to Double Bullnose On Edge and to Bullnose Double Header On Flat (Square Corner On Bed)

TYPE NO.	A	B	C	R
BN.19.1 ●	215	215	102	25
BN.19.2 ●	215	215	102	51
BN.19.3	215	215	65	25
BN.19.4	215	215	65	51

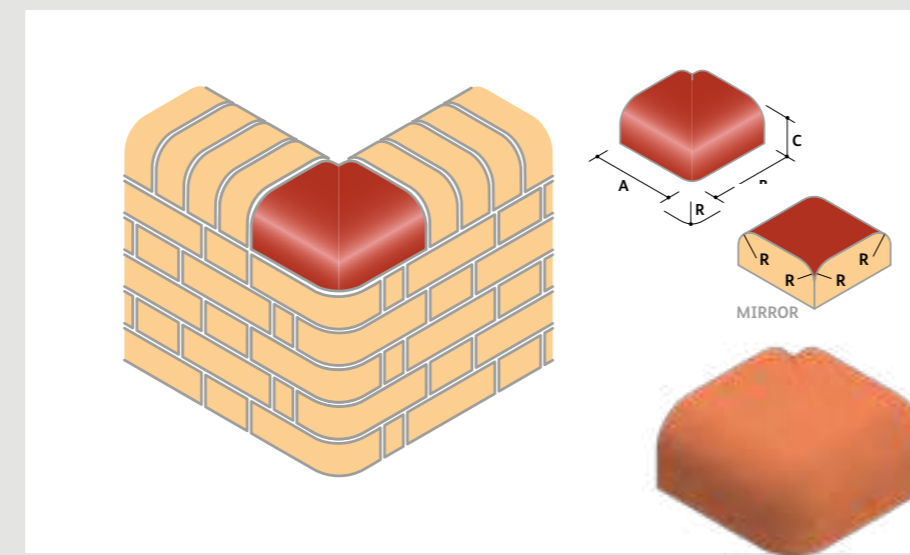

BN.20 External Return to Double Bullnose On Edge & to Bullnose Double Header On Flat (Rounded Corner On Bed)

TYPE NO.	A	B	C	R
BN.20.1	215	215	102	25
BN.20.2	215	215	102	51
BN.20.3	215	215	65	25
BN.20.4	215	215	65	51

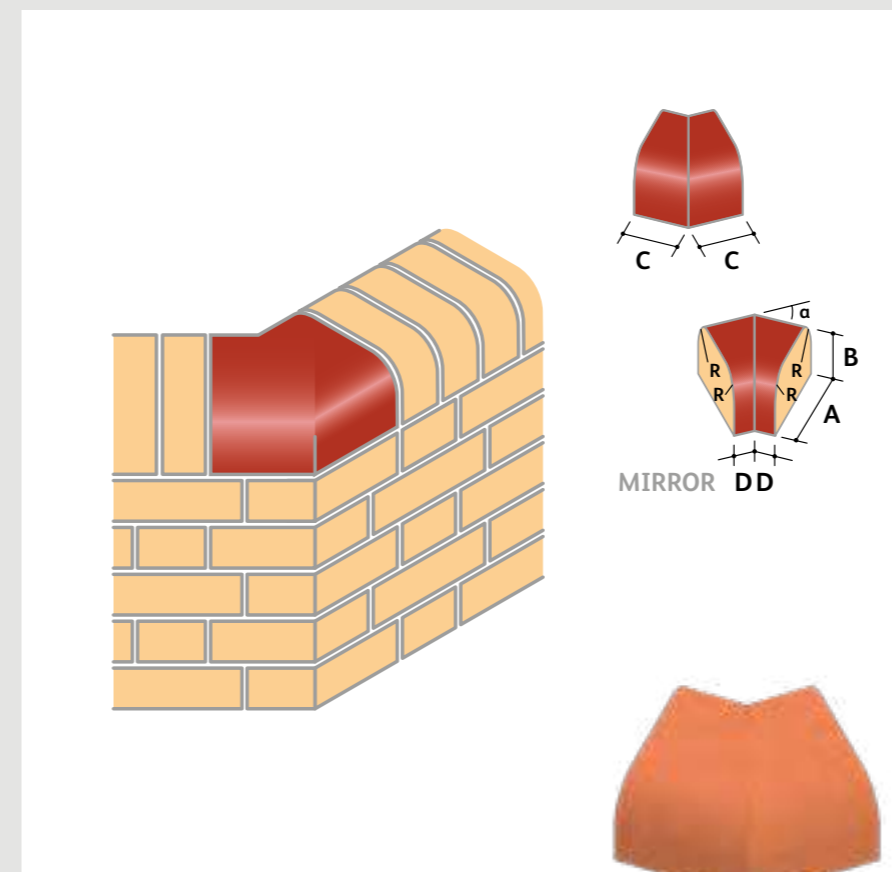

BN.21 Double Bullnose External Angle to Double Bullnose On Edge and to Bullnose Double Header On Flat

TYPE NO.	A	B	C	D	R	α
BN.21.1	215	102	159	101	25	30°
BN.21.2	215	102	159	101	51	30°
BN.21.3	215	65	159	101	25	30°
BN.21.4	215	65	159	101	51	30°
BN.21.5	215	102	159	70	25	45°
BN.21.6	215	102	159	70	51	45°
BN.21.7	215	65	159	70	25	45°
BN.21.8	215	65	159	70	51	45°
BN.21.9	215	102	159	35	25	60°
BN.21.10	215	102	159	35	51	60°
BN.21.11	215	65	159	35	25	60°
BN.21.12	215	65	159	35	51	60°

● To complement the Everyday Range, Ibstock Kevington provides the perfect design details to finish off corners.

SHELF ANGLE BRICKS

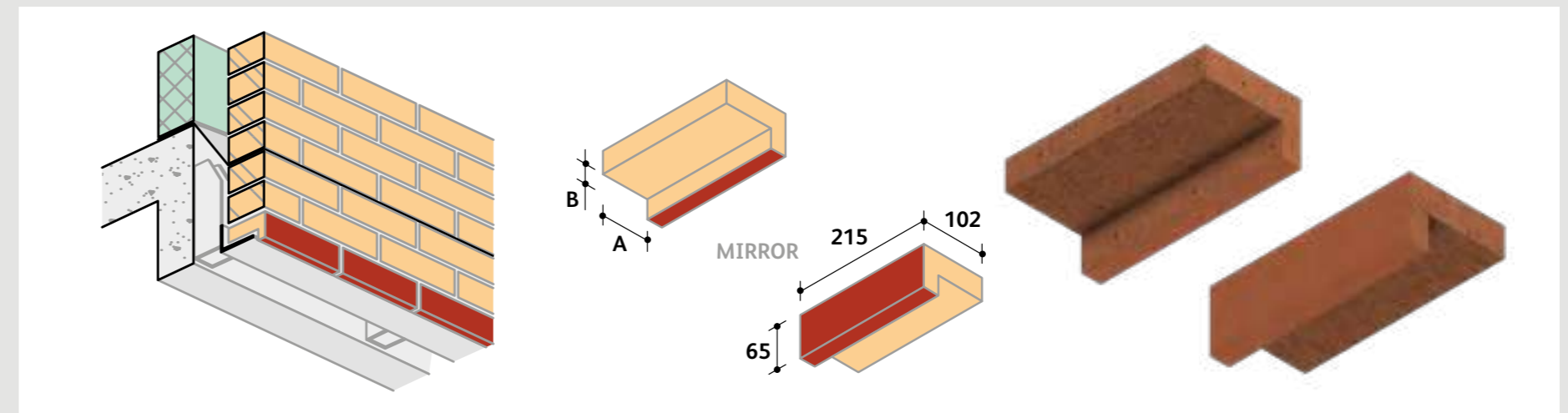
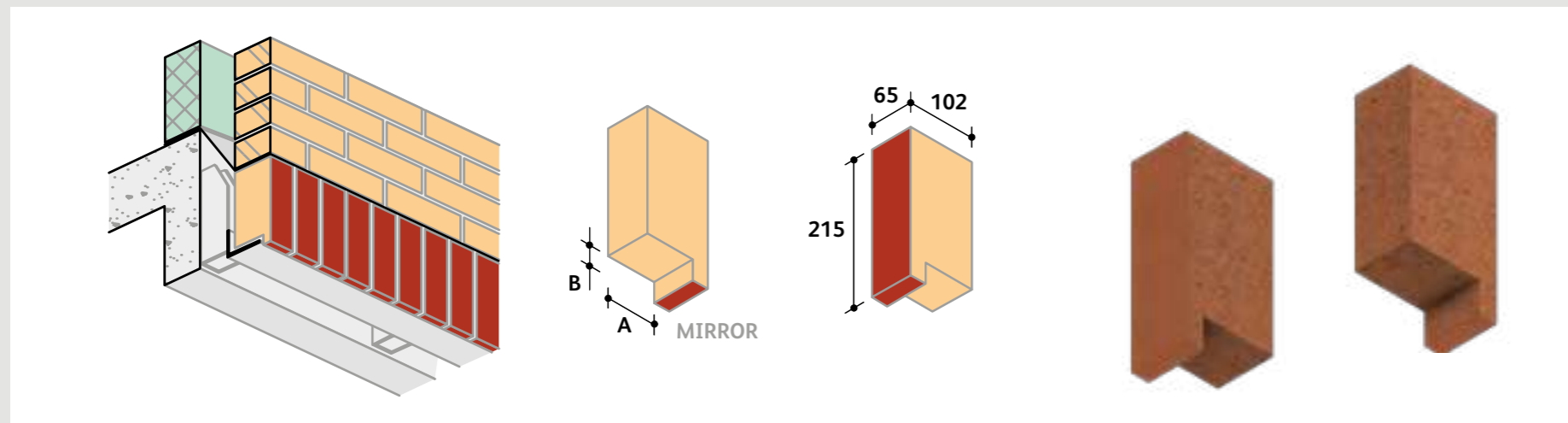

I.SA.1 Rebated Soldier

I.SA.4 Rebated Stretcher

TYPE NO.	A	B
I.SA.1.1	82	15
I.SA.1.2	82	25
I.SA.1.3	82	35
I.SA.1.4	77	15
I.SA.1.5	77	25

TYPE NO.	A	B
I.SA.1.6	77	35
I.SA.1.7	72	15
I.SA.1.8	72	25
I.SA.1.9	72	35

TYPE NO.	A	B
I.SA.4.1	82	15
I.SA.4.2	82	25
I.SA.4.3	82	35
I.SA.4.4	77	15
I.SA.4.5	77	25

TYPE NO.	A	B
I.SA.4.6	77	35
I.SA.4.7	72	15
I.SA.4.8	72	25
I.SA.4.9	72	35

SOLDIER BRICKS

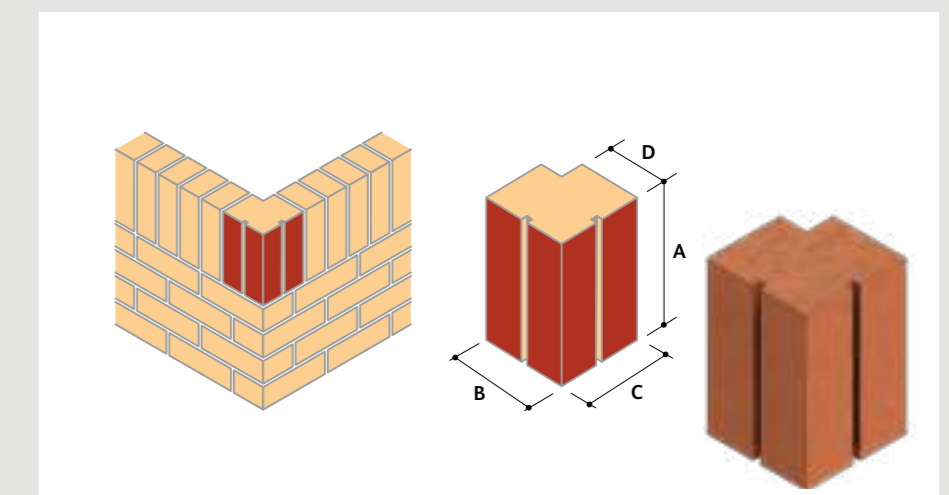
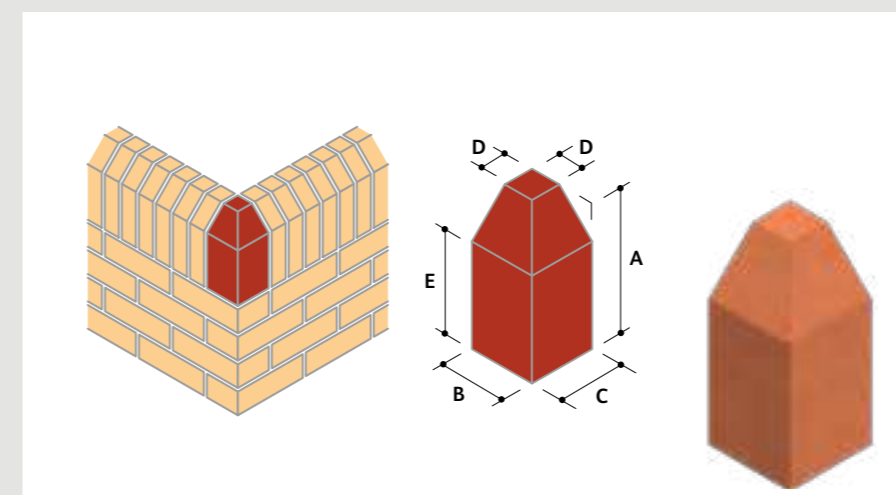
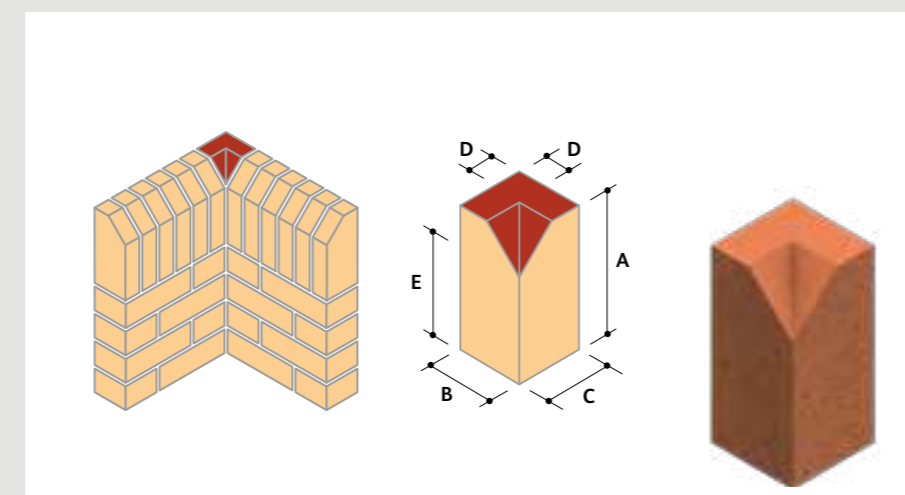
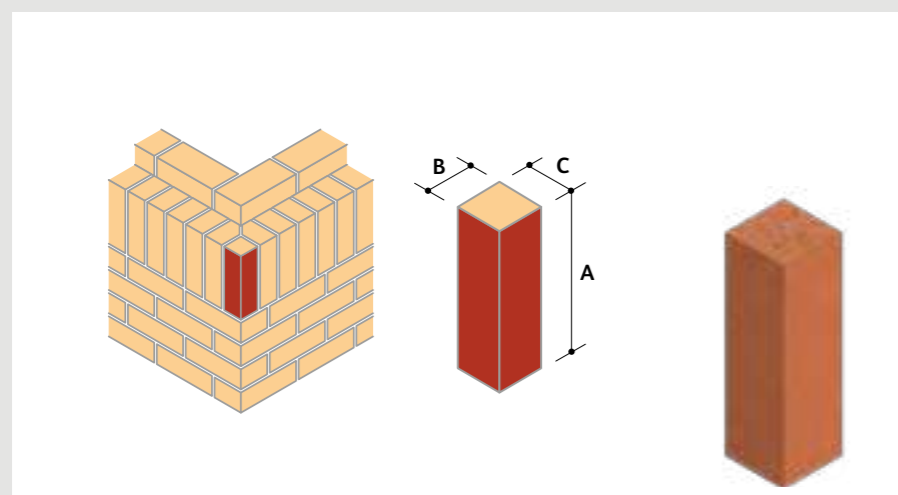

SD.1 Soldier External Return

SD.2 Soldier Internal Return To Single Cant On End*

SD.3 Soldier External Return To Single Cant On End*

I.SD.4 Soldier External Return

TYPE NO.	A	B	C
SD.1.1	215	65	65
SD.1.2	215	102	102

TYPE NO.	A	B	C	D	E
SD.2.1	215	102	102	46	159
SD.2.2	215	102	102	60	173

TYPE NO.	A	B	C	D	E
SD.3.1	215	102	102	46	159
SD.3.2	215	102	102	60	173

TYPE NO.	A	B	C	D
I.SD.4	215	140	140	102

● To complement the Everyday Range, Istock Kevington provides the perfect design details to finish off corners.
* May be used in Sill or Plinth situations.

EASYANGLE® & UNIVERSAL JOINT BRICKS

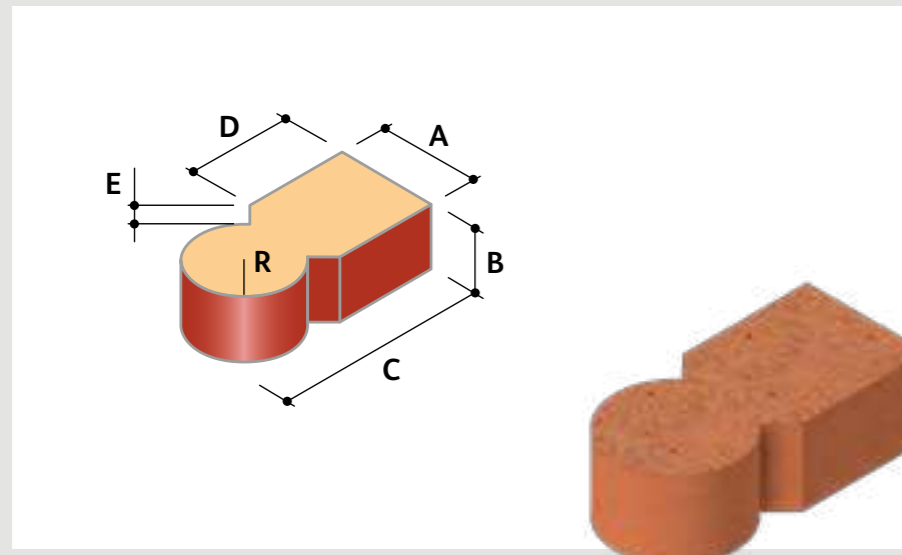

I.U.J.1 Universal Joint Male

TYPE NO.	A	B	C	D	E	R
I.U.J.1	102	65	215	106	26	51

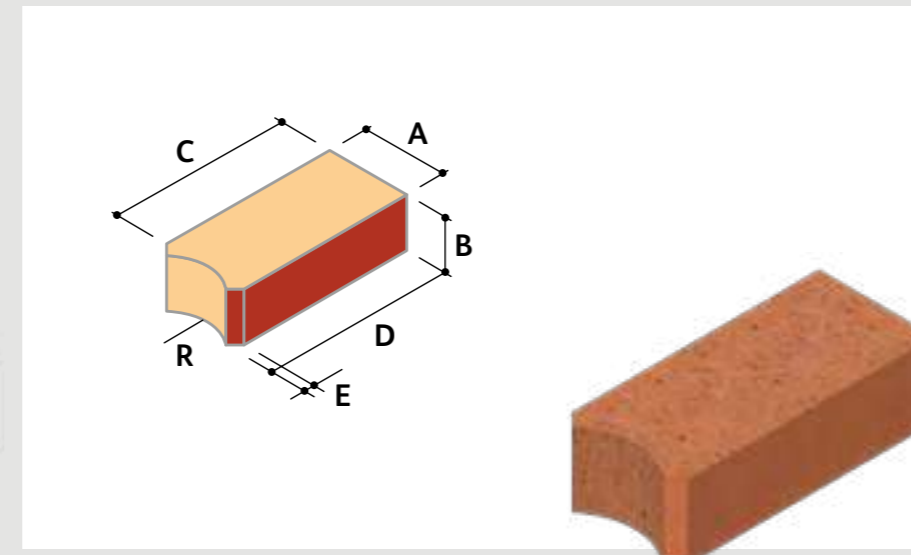

I.U.J.2 Universal Joint Female

TYPE NO.	A	B	C	D	E	R
I.U.J.2	102	65	218	230	12	61

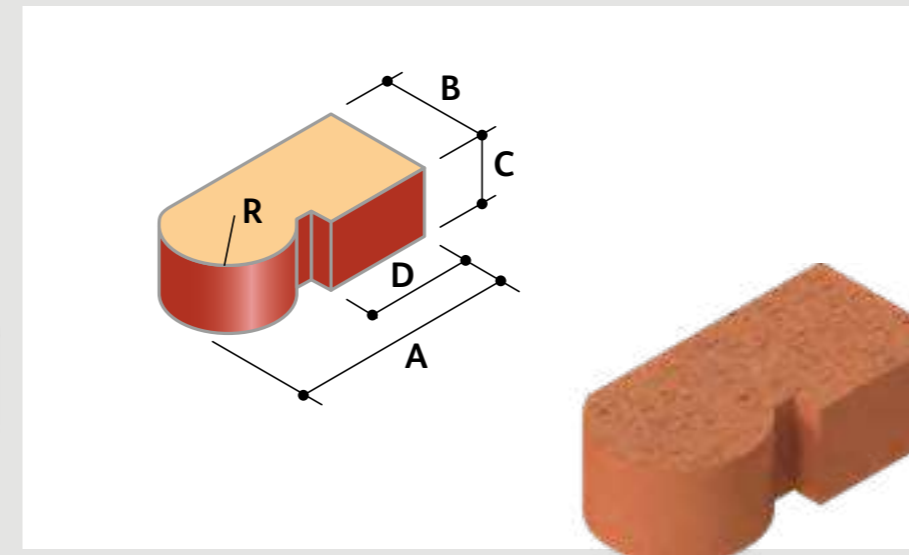

I.U.J.7 Easyangle® (Left & Right Hand)

TYPE NO.	A	B	C	D	R
I.U.J.7.1	215	102	65	102	54

SPIRAL & PINEAPPLE BRICKS

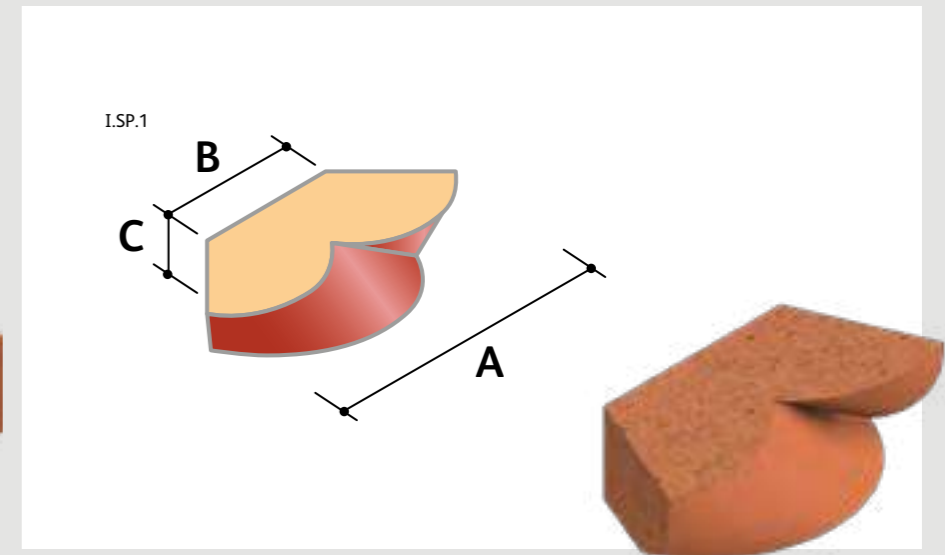

I.SP.1 Spiral Brick To 400mm Diameter Column

TYPE NO.	A	B	C	HELIX ROTATION
I.SP.1.1	275	180	65	Clockwise
I.SP.1.2	275	180	65	Anti-clockwise

I.SP.2 Spiral Brick To 600mm Diameter Column

TYPE NO.	A	B	C	HELIX ROTATION
I.SP.2.1	220	143	65	Clockwise
I.SP.2.2	220	143	65	Anti-clockwise

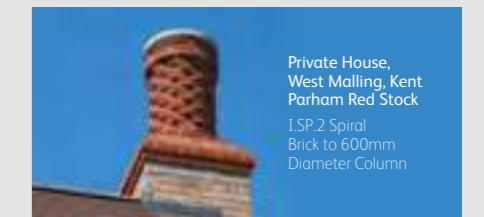
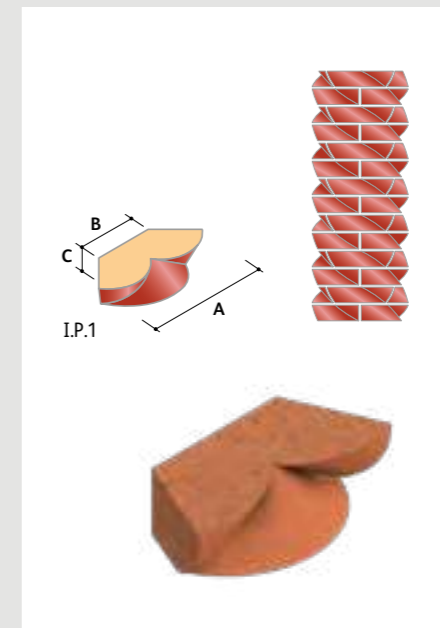
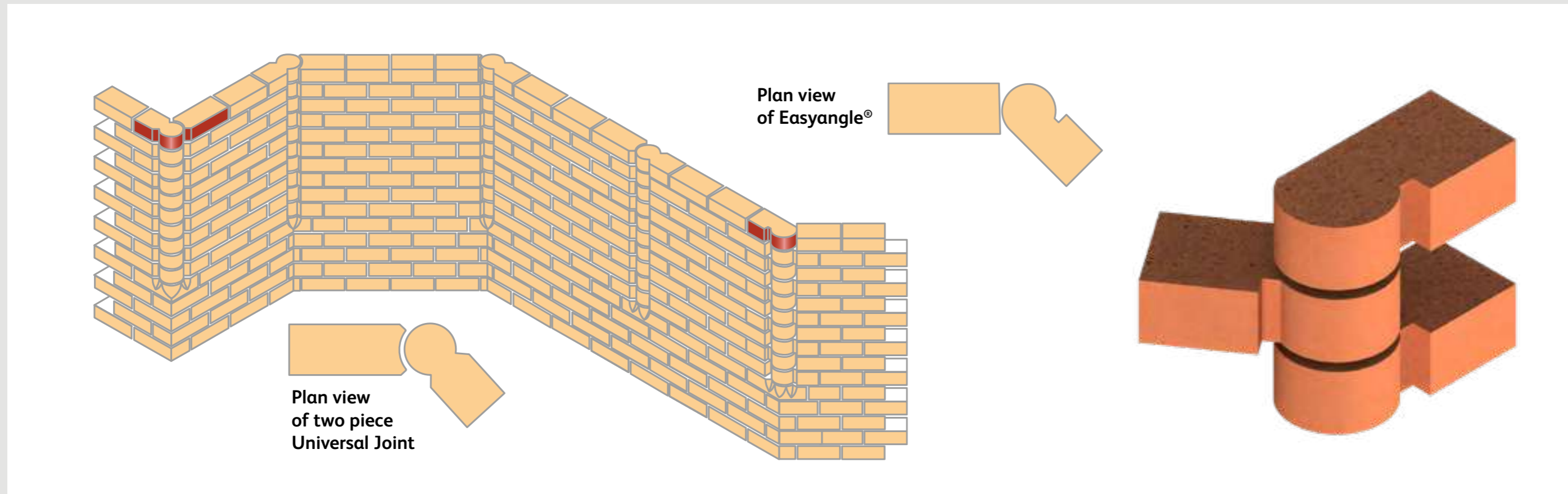

I.P.1 Pineapple Brick To 400mm Diameter Column

TYPE NO.	A	B	C
I.P.1	275	180	65

I.P.2 Pineapple Brick To 600mm Diameter Column

TYPE NO.	A	B	C
I.P.2	220	143	65

• To complement the Everyday Range, Ibstock Kevington provides the perfect design details to finish off corners.

PLINTH BRICKS

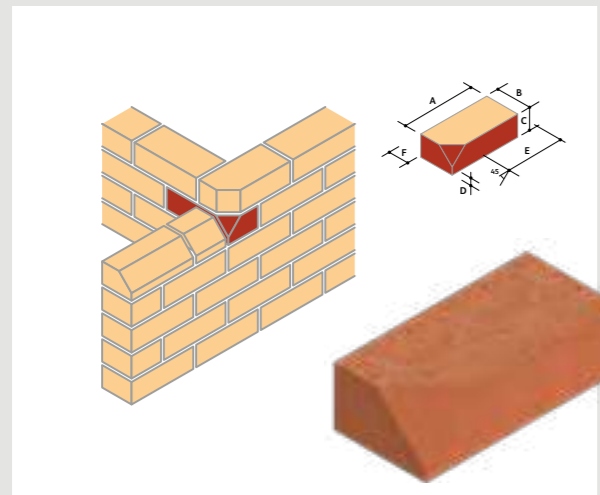

PL.1 Plinth Stop Or Cant Stop
(Left & Right Hand)*

TYPE NO.	A	B	C	D	E	F
PL.1.1 ●	215	102	65	9	159	46
PL.1.2 ●	215	102	65	23	173	60

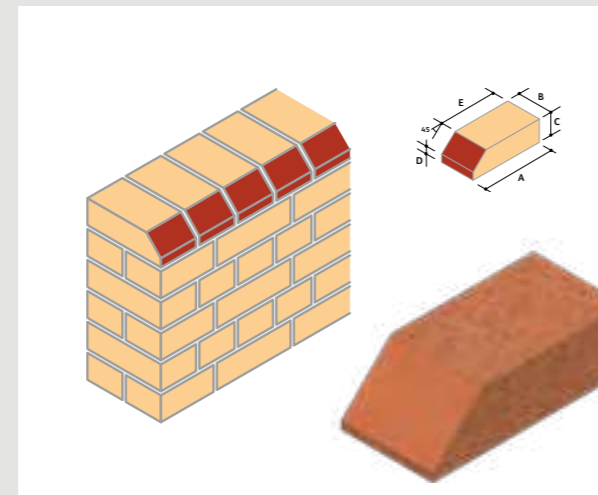

PL.2 Plinth Header*

TYPE NO.	A	B	C	D	E
PL.2.1 *	215	102	65	9	159
PL.2.2 *	215	102	65	23	173

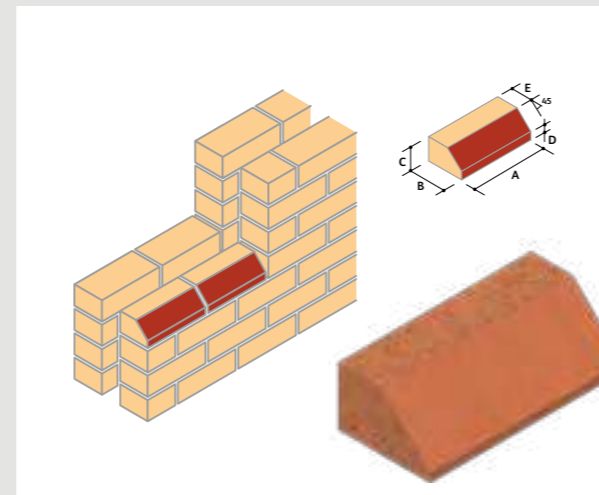

PL.3 Plinth Stretcher*

TYPE NO.	A	B	C	D	E
PL.3.1 *	215	102	65	9	46
PL.3.2 *	215	102	65	23	60

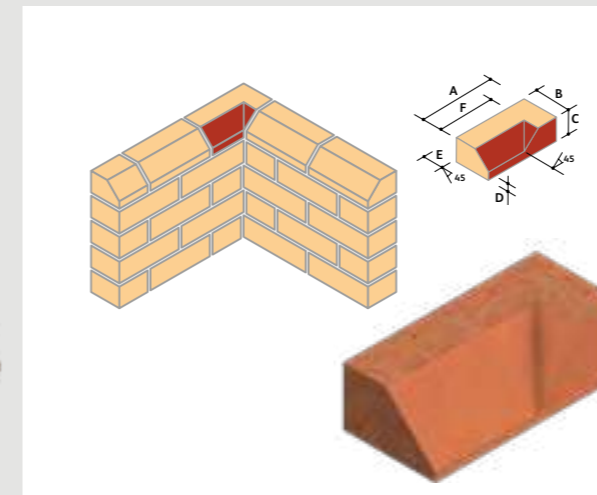

PL.4 Plinth Internal Return - long
(Left & Right Hand)*

TYPE NO.	A	B	C	D	E	F
PL.4.1 *	215	102	65	9	46	169
PL.4.2 *	215	102	65	23	60	155

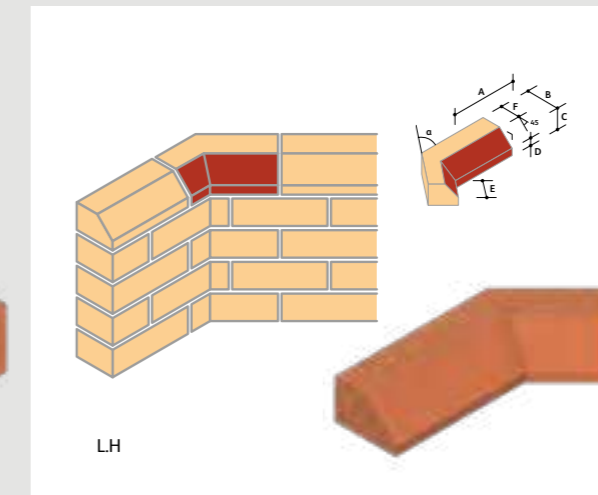

PL.6 Plinth Internal Angle
(Left & Right Hand)*

TYPE NO.	A	B	C	D	E	F	α
PL.6.1+	164	102	65	9	51	46	30°
PL.6.2+	164	102	65	23	51	60	30°
PL.6.3+	164	102	65	9	51	46	45°
PL.6.4+	164	102	65	23	51	60	45°
PL.6.5+	164	102	65	9	51	46	60°
PL.6.6+	164	102	65	23	51	60	60°
PL.6.7◆	159	102	65	9	102	46	30°
PL.6.8◆	159	102	65	23	102	60	30°
PL.6.9◆	159	102	65	9	102	46	45°
PL.6.10◆	159	102	65	23	102	60	45°
PL.6.11◆	159	102	65	9	102	46	60°
PL.6.12◆	159	102	65	23	102	60	60°
PL.6.13+	215	102	65	9	102	46	30°
PL.6.14+	215	102	65	23	102	60	30°
PL.6.15+	215	102	65	9	102	46	45°
PL.6.16+	215	102	65	23	102	60	45°
PL.6.17+	215	102	65	9	102	46	60°
PL.6.18+	215	102	65	23	102	60	60°

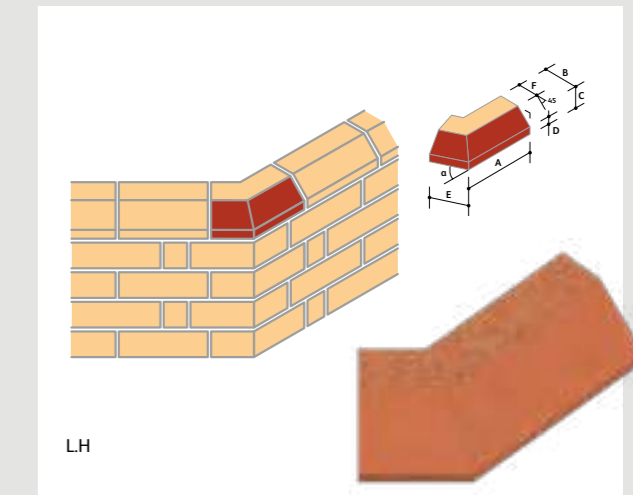

PL.8 Plinth External Angle
(Left & Right Hand)*

TYPE NO.	A	B	C	D	E	F	α
PL.8.1◆	159	102	65	9	102	46	30°
PL.8.2◆	159	102	65	23	102	60	30°
PL.8.3◆	159	102	65	9	102	46	45°
PL.8.4◆	159	102	65	23	102	60	45°
PL.8.5◆	159	102	65	9	102	46	60°
PL.8.6◆	159	102	65	23	102	60	60°
PL.8.7+	215	102	65	9	102	46	30°
PL.8.8+	215	102	65	23	102	60	30°
PL.8.9+	215	102	65	9	102	46	45°
PL.8.10+	215	102	65	23	102	60	45°
PL.8.11+	215	102	65	9	102	46	60°
PL.8.12+	215	102	65	23	102	60	60°

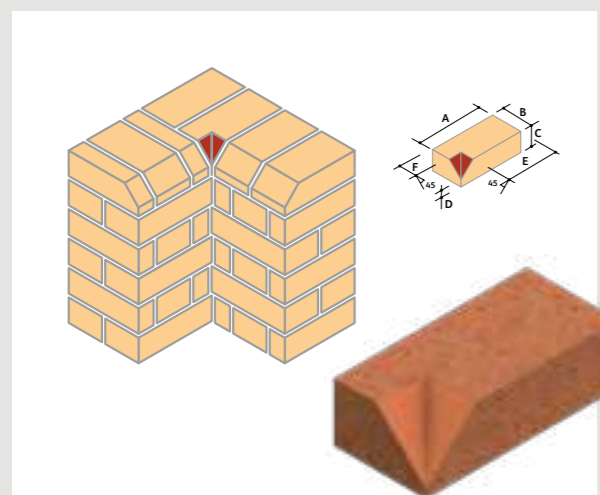

PL.5 Plinth Internal Return - short
(Left & Right Hand)*

TYPE NO.	A	B	C	D	E	F
PL.5.1	215	102	65	9	159	46
PL.5.2	215	102	65	23	173	60

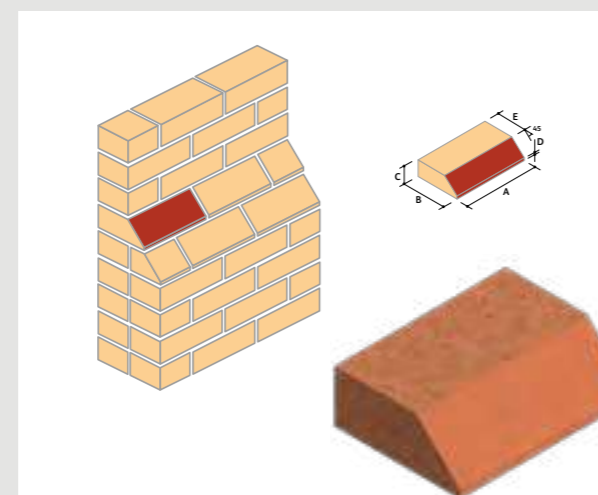

I.PL.15 Wide Bed Plinth Stretcher

TYPE NO.	A	B	C	D	E
I.PL.15.1	215	158	65	9	102

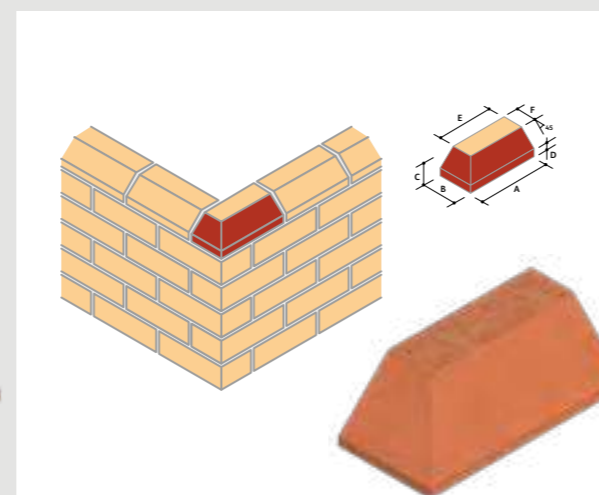

PL.7 Plinth Internal Return - short
(Left & Right Hand)*

TYPE NO.	A	B	C	D	E	F
PL.7.1	215	102	65	9	159	46
PL.7.2	215	102	65	23	173	60

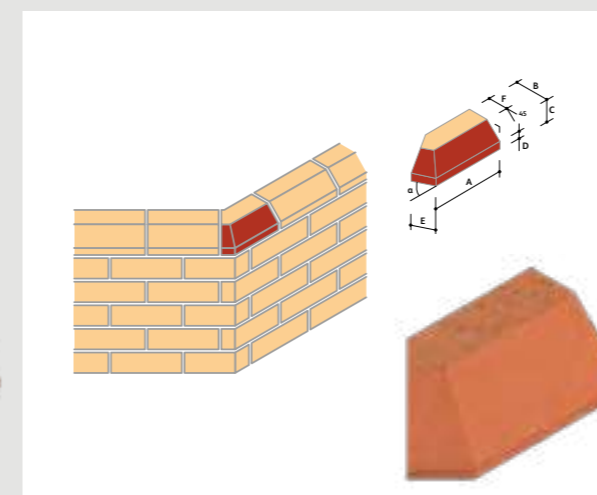

PL.9 Plinth Squint
(Left & Right Hand)*

TYPE NO.	A	B	C	D	E	F	α
PL.9.1+	164	102	65	9	51	46	30°
PL.9.2+	164	102	65	23	51	60	30°
PL.9.3+	164	102	65	9	51	46	45°
PL.9.4+	164	102	65	23	51	60	45°
PL.9.5+	164	102	65	9	51	46	60°
PL.9.6+	164	102	65	23	51	60	60°

● To complement the Everyday Range, Ibstock Kevington provides the perfect design details to finish off corners.

* Extra faces available. + Suitable for half bond without cutting. ◆ Suitable for quarter bond without cutting.

BONDING BRICKS

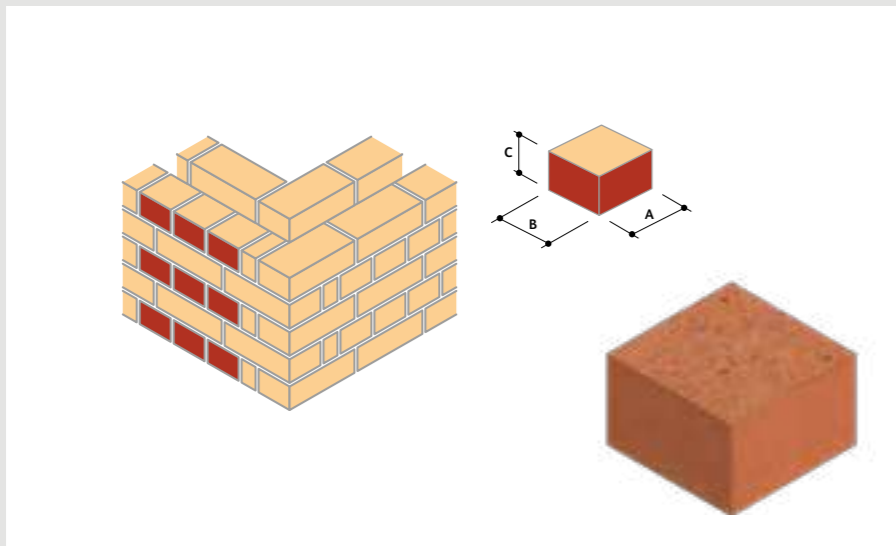

BD.1.1 Half Bat (Snap Header)

TYPE NO.	A	B	C
BD.1.1	102	102	65

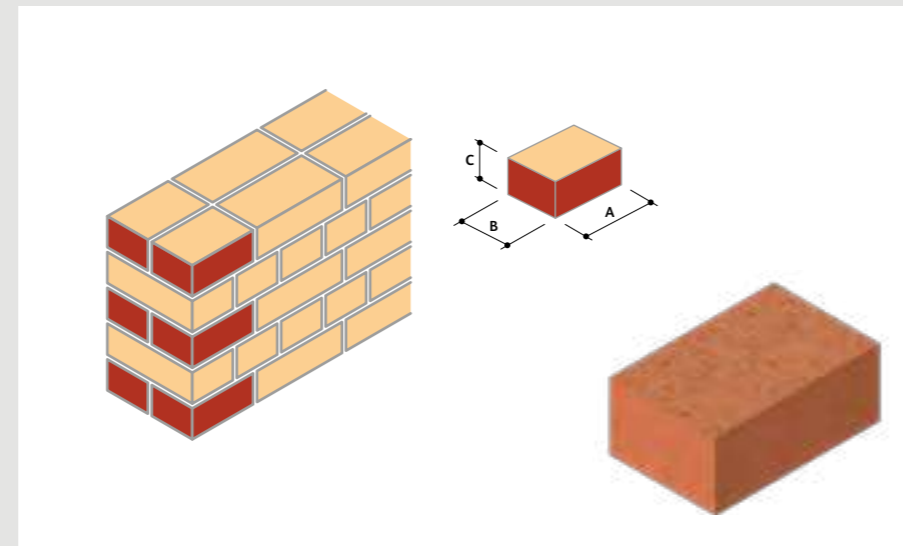

BD.1.2 Three-quarter Bat

TYPE NO.	A	B	C
BD.1.2	159	102	65

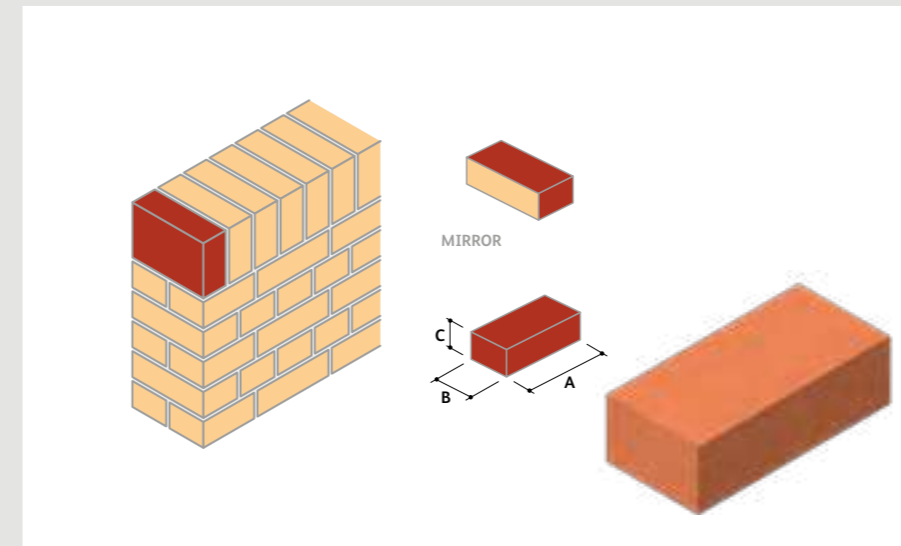

BD.1.3 Standard Brick fair-faced On Bed Surface

TYPE NO.	A	B	C
BD.1.3 *	215	102	65

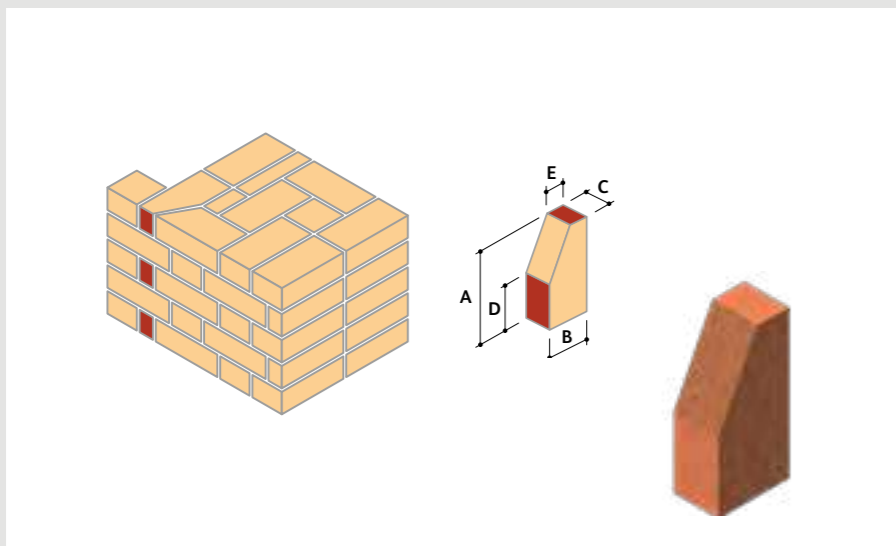

BD.2 King Closer

TYPE NO.	A	B	C	D	E
BD.2	215	102	65	102	46

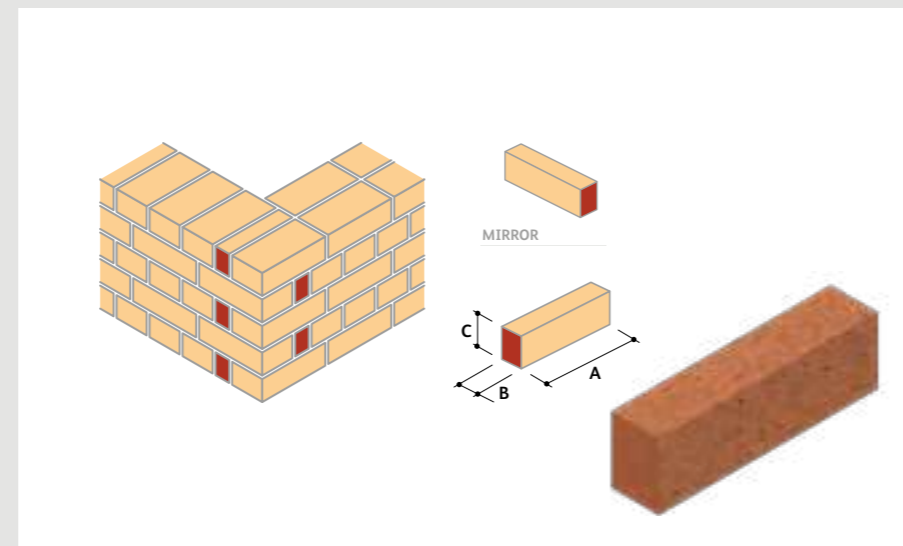

BD.3 Queen Closer

TYPE NO.	A	B	C
BD.3	215	46	65

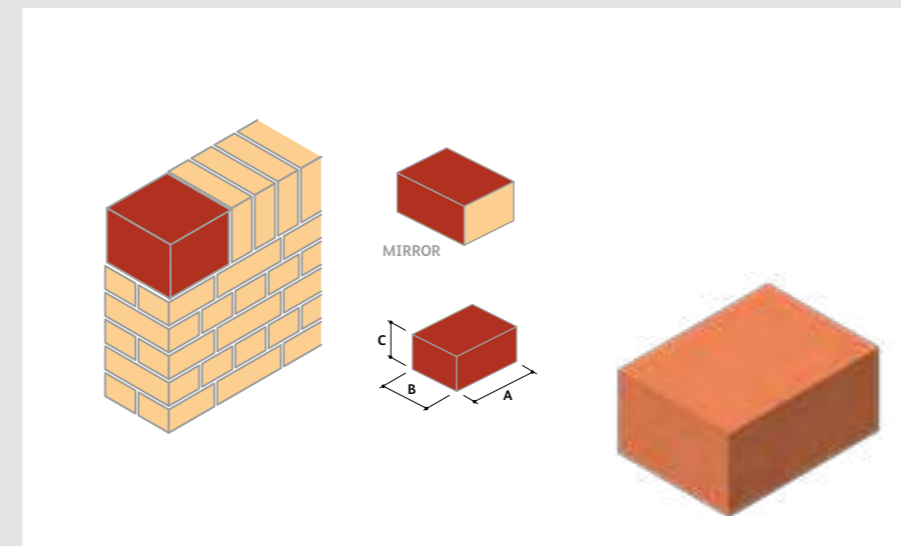

BD.4 215mm Square Stop End

TYPE NO.	A	B	C
BD.4.1	215	159	102
BD.4.2	215	159	65
BD.4.3	215	215	102
BD.4.4	215	215	65

SLIP BRICKS

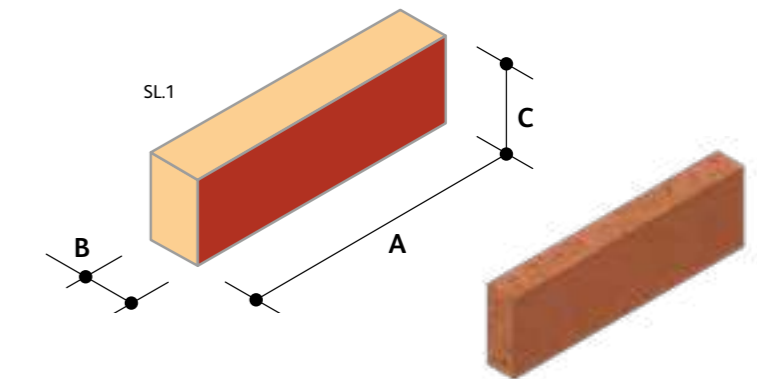

SL.1 Brick Face Slip

TYPE NO.	A	B	C
SL.1.1	215	25	65
SL.1.2	215	30	65
SL.1.3	215	40	65
SL.1.4	215	50	65

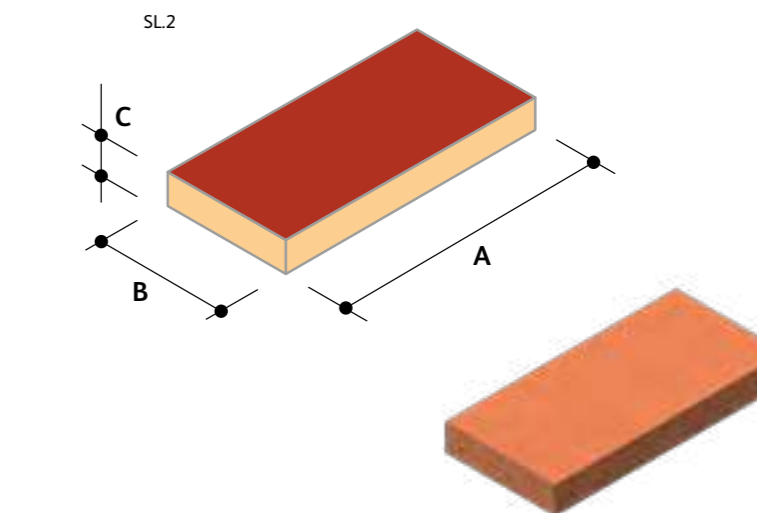

SL.2 Brick Bed Slip

TYPE NO.	A	B	C
SL.2	215	102	25

• To complement the Everyday Range, Ibstock Kevington provides the perfect design details to finish off corners.

ANGLE & CANT BRICKS

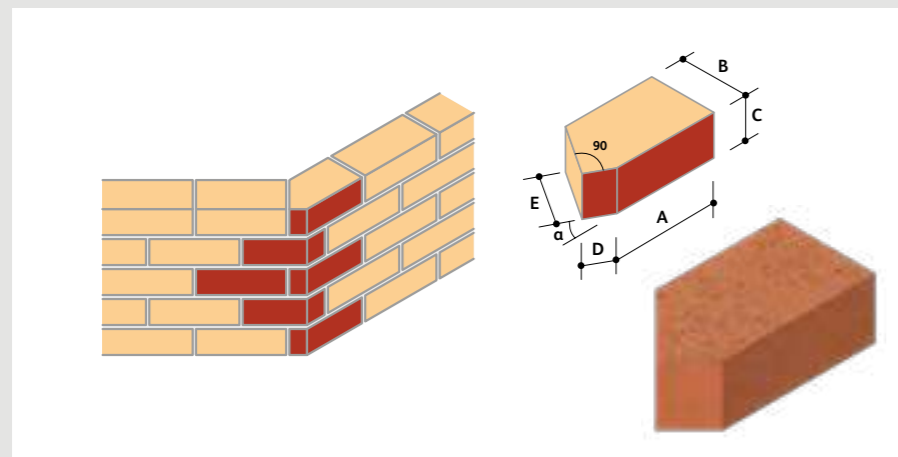

AN.1 Squint Brick (Left & Right Hand)

TYPE NO.	A	B	C	D	E	α
AN.1.1+	164	102	65	51	89	30°
AN.1.2+*	164	102	65	51	94	45°
AN.1.3+	164	102	65	51	117	60°

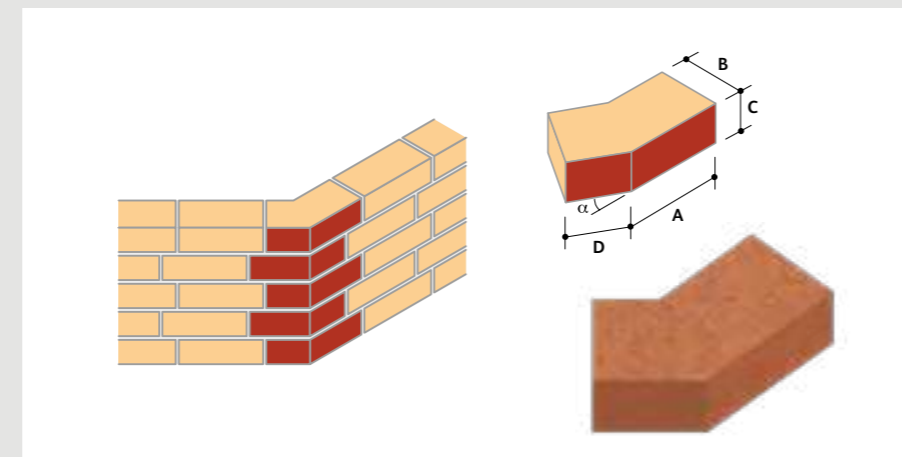

AN.2 External Angle (Left & Right Hand)

TYPE NO.	A	B	C	D	E
AN.2.1♦*	159	102	65	102	30°
AN.2.2♦	159	102	65	102	45°
AN.2.3♦	159	102	65	102	60°
AN.2.4+	215	102	65	102	30°
AN.2.5+	215	102	65	102	45°
AN.2.6+	215	102	65	102	60°

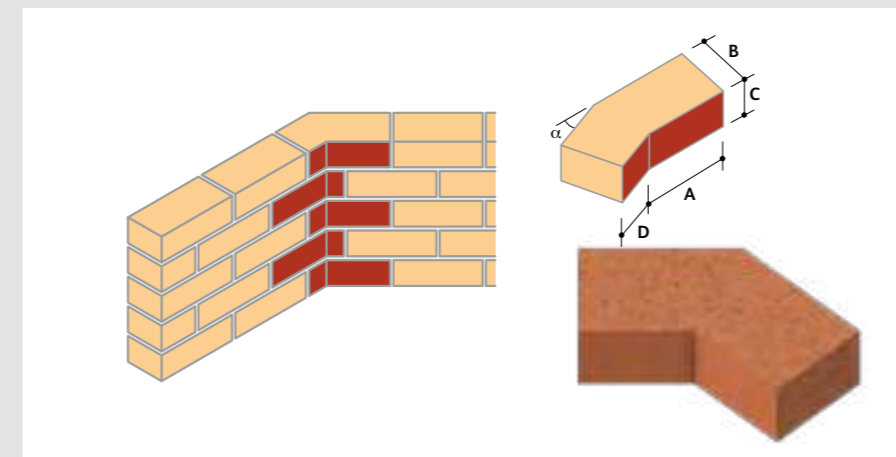

AN.3 Internal Angle (Dog Leg) (Left & Right Hand)

TYPE NO.	A	B	C	D	E
AN.3.1+*	164	102	65	51	30°
AN.3.2+	164	102	65	51	45°
AN.3.3+	164	102	65	51	60°
AN.3.4♦	159	102	65	102	30°
AN.3.5♦	159	102	65	102	45°
AN.3.6♦	159	102	65	102	60°
AN.3.7+	215	102	65	102	30°
AN.3.8+	215	102	65	102	45°
AN.3.9+	215	102	65	102	60°

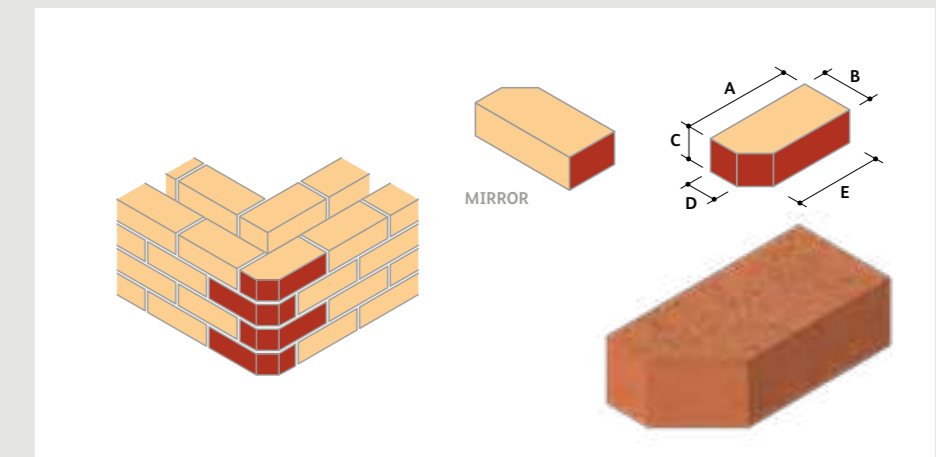

AN.5 Single Cant (Left & Right Hand) ⓘ

TYPE NO.	A	B	C	D	E
AN.5.1*	215	102	65	46	159
AN.5.2	215	102	65	60	173

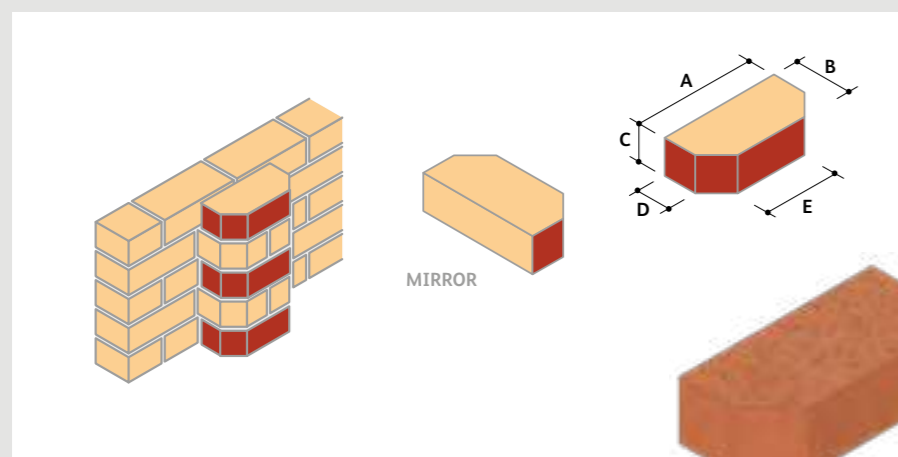

AN.6 Double Cant

TYPE NO.	A	B	C	D	E
AN.6.1*	215	102	65	46	103
AN.6.2*	215	102	65	60	131

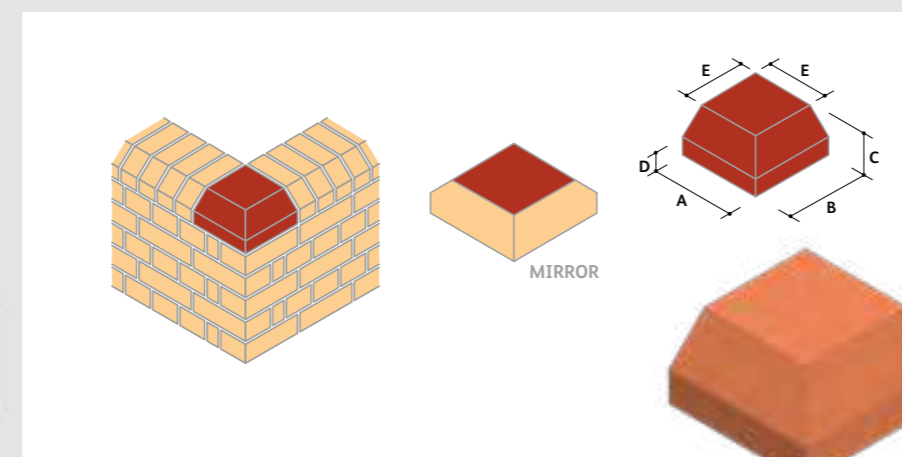

AN.7 Single Cant External Return ⓘ

TYPE NO.	A	B	C	D	E
AN.7.1●	215	215	102	46	159
AN.7.2●	215	215	102	60	173

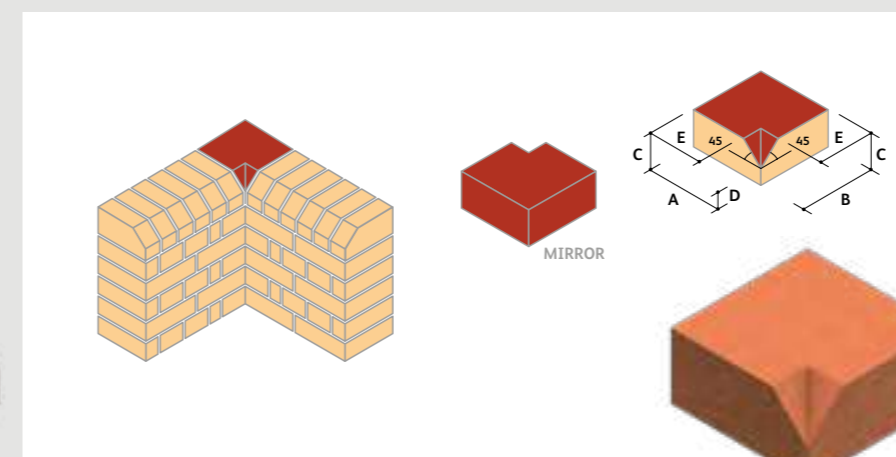

AN.8 Single Cant Internal Return w/ Int. Mitre (Sq. External Corner On Bed) ⓘ

TYPE NO.	A	B	C	D	E
AN.8.1	215	215	102	46	159
AN.8.2	215	215	102	60	173

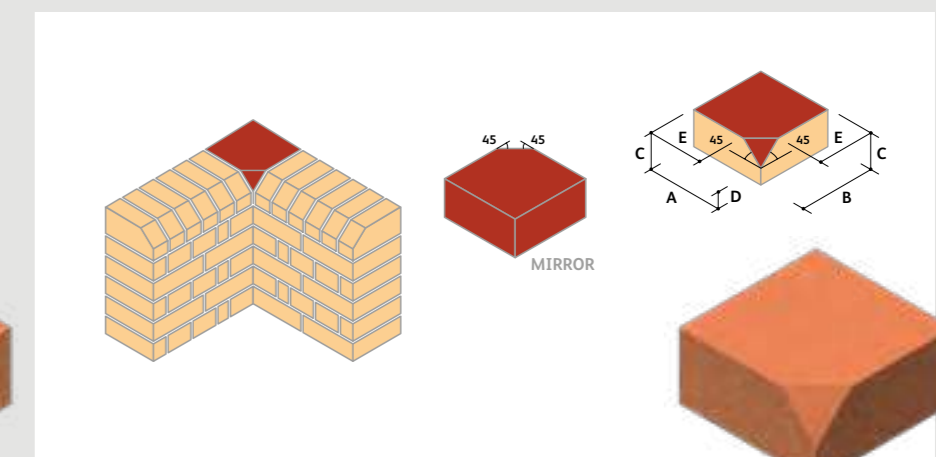

AN.9 Single Cant Internal Return w/ Int. Slope (Sq. External Corner On Bed) ⓘ

TYPE NO.	A	B	C	D	E
AN.9.1	215	215	102	46	159
AN.9.2	215	215	102	60	173

● To complement the Everyday Range, Ibstock Kevington provides the perfect design details to finish off corners.
+ Suitable for half bond without cutting; ♦ Suitable for quarter bond without cutting.

ANGLE & CANT BRICKS

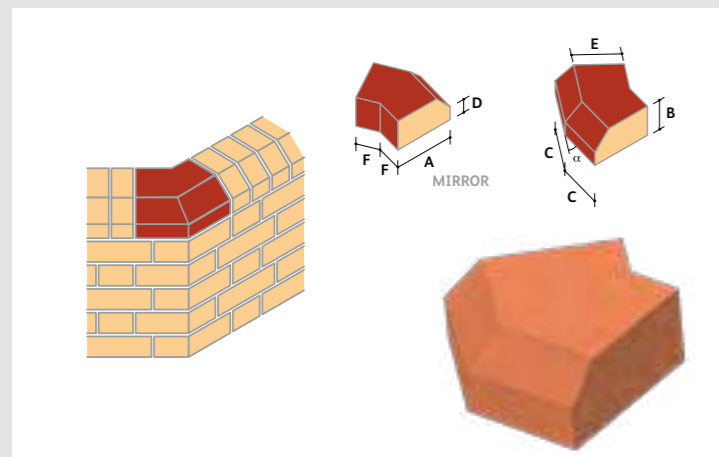

AN.10 Single Cant External Angle

TYPE NO.	A	B	C	D	E	F	α
AN.10.1	215	102	159	46	159	101	30°
AN.10.2	215	102	159	60	173	101	30°
AN.10.3	215	102	159	46	159	70	45°
AN.10.4	215	102	159	60	173	70	45°
AN.10.5	215	102	159	46	159	35	60°
AN.10.6	215	102	159	60	173	35	60°

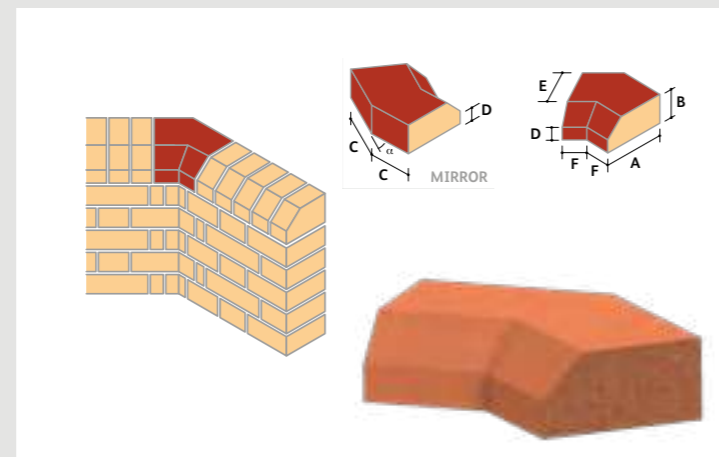

AN.11 Single Cant Internal Angle

TYPE NO.	A	B	C	D	E	F	α
AN.11.1	215	102	159	46	159	101	30°
AN.11.2	215	102	159	60	173	101	30°
AN.11.3	215	102	159	46	159	70	45°
AN.11.4	215	102	159	60	173	70	45°
AN.11.5	215	102	159	46	159	35	60°
AN.11.6	215	102	159	60	173	35	60°

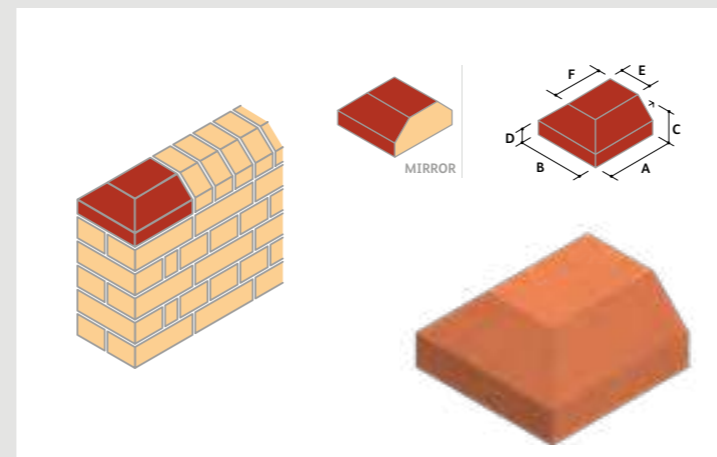

AN.12 Double Cant Stop End
(Square Corners On Bed)

TYPE NO.	A	B	C	D	E	F
AN.12.1 ●	215	215	102	46	103	159
AN.12.2 ●	215	215	102	60	131	173

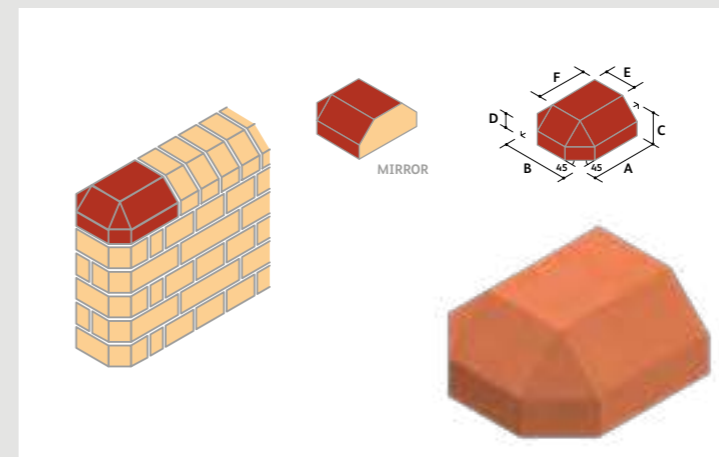

AN.13 Double Cant Stop End
(Canted Corners On Bed)

TYPE NO.	A	B	C	D	E	F
AN.13.1	215	215	102	46	103	159
AN.13.2	215	215	102	60	131	173

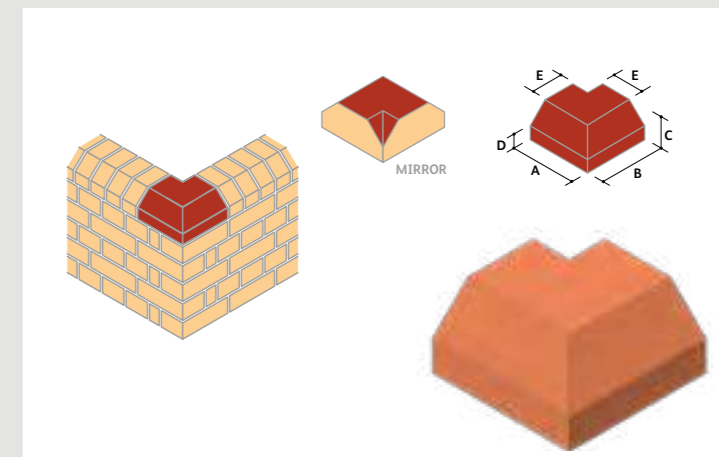

AN.14 Double Cant External Return with Internal Mitre
(Square Corner On Bed)

TYPE NO.	A	B	C	D	E
AN.14.1	215	215	102	46	103
AN.14.2	215	215	102	60	131

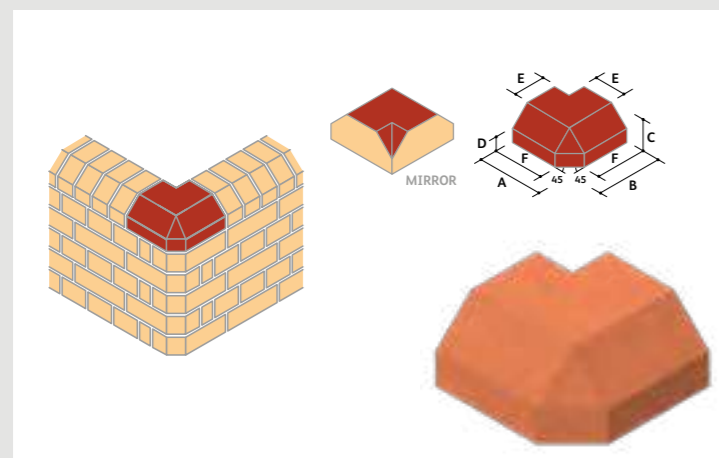

AN.15 Double Cant External Return with Internal Mitre
(Canted Corner On Bed)

TYPE NO.	A	B	C	D	E	F
AN.15.1	215	215	102	46	103	159
AN.15.2	215	215	102	60	131	173

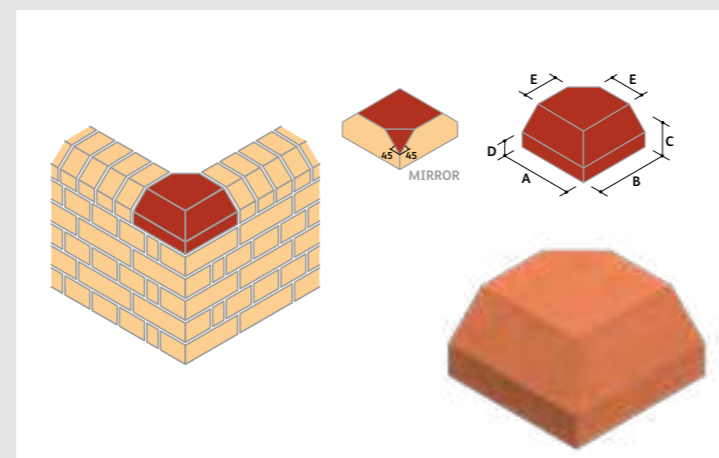

AN.16 Double Cant External Return with Internal Slope
(Square Corner On Bed)

TYPE NO.	A	B	C	D	E
AN.16.1	215	215	102	46	103
AN.16.2	215	215	102	60	131

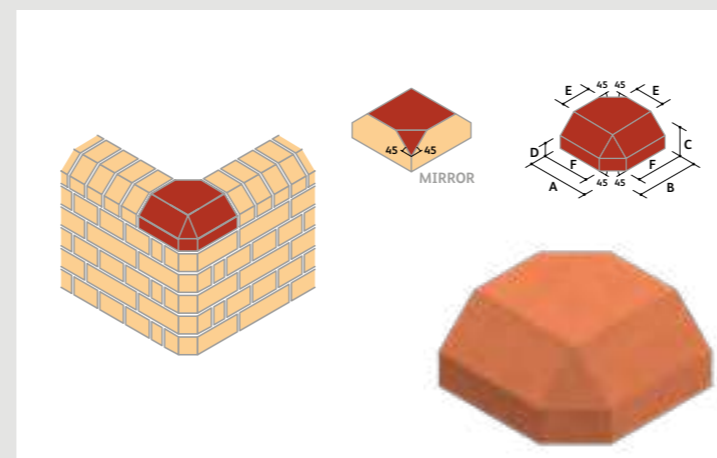

AN.17 Double Cant External Return with Internal Slope
(Canted Corners On Bed)

TYPE NO.	A	B	C	D	E	F
AN.17.1	215	215	102	46	103	159
AN.17.2	215	215	102	60	131	173

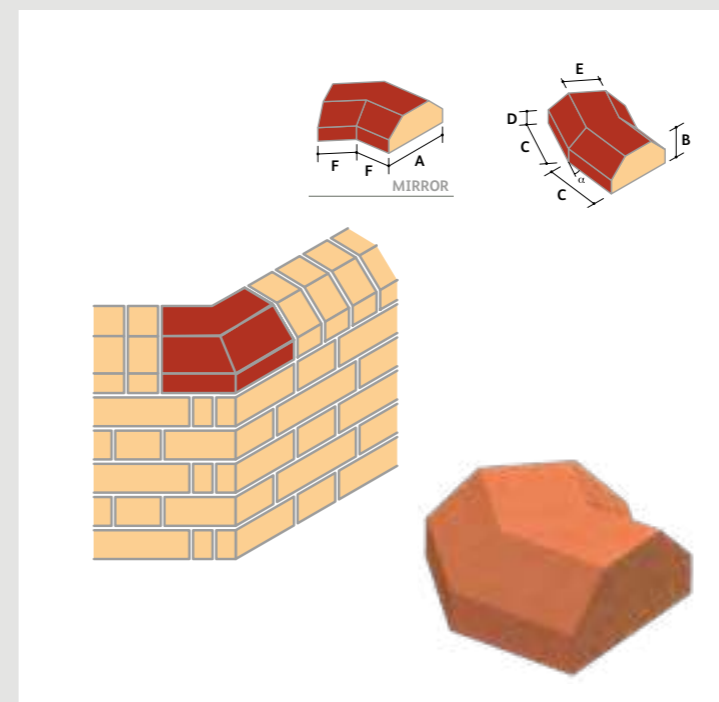

AN.18 Double Cant Angle

TYPE NO.	A	B	C	D	E	F	α
AN.18.1	215	102	159	46	103	101	30°
AN.18.2	215	102	159	60	131	101	30°
AN.18.3	215	102	159	46	103	70	45°
AN.18.4	215	102	159	60	131	70	45°
AN.18.5	215	102	159	46	103	35	60°
AN.18.6	215	102	159	60	131	35	60°

● To complement the Everyday Range, Ibstock Kevington provides the perfect design details to finish off corners.

CAPPING & COPING BRICKS

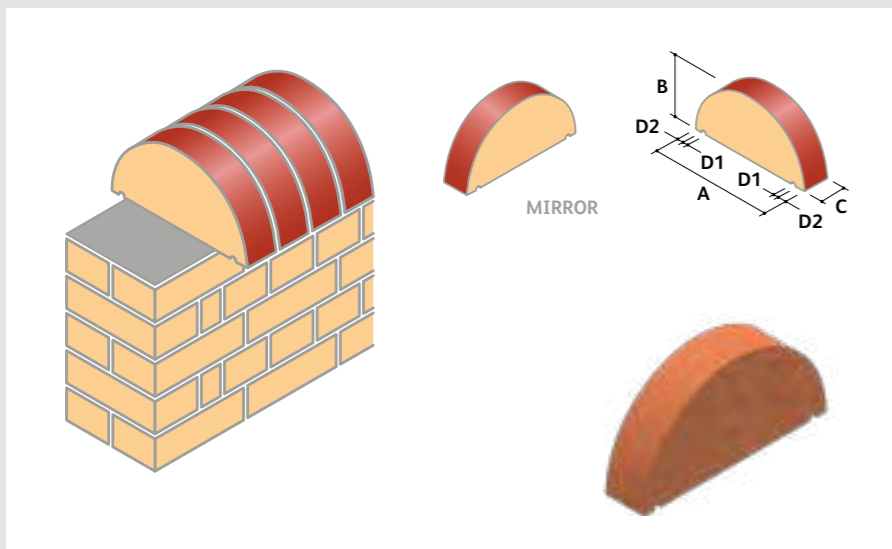

CP.1.1 Half Round Copping

TYPE NO.	A	B	C	D1	D2
CP.1.1	305	153	65	13	15

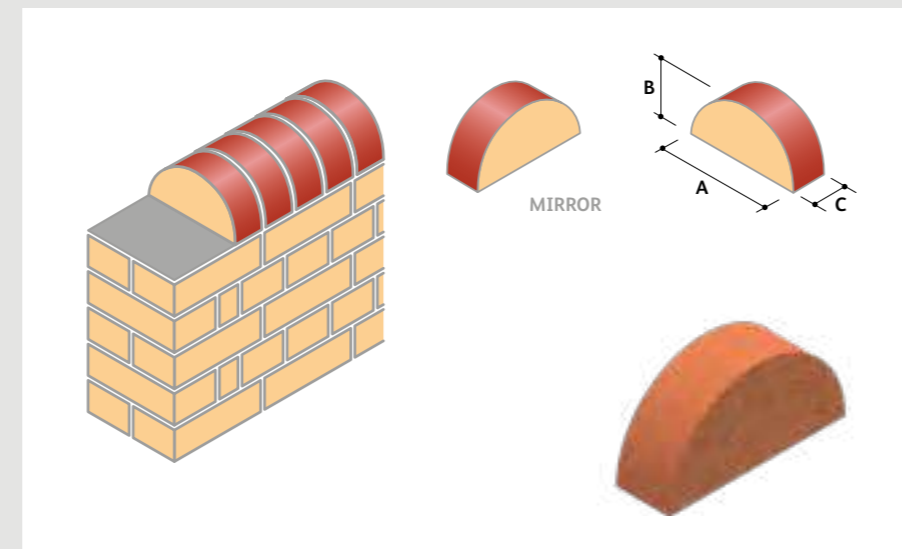

CP.1.2 Half Round Capping

TYPE NO.	A	B	C
CP.1.2	215	108	65

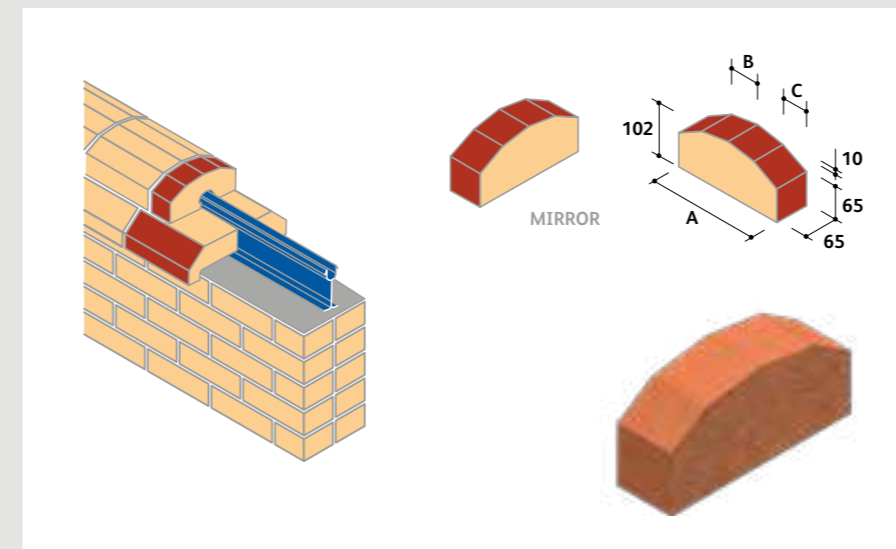

I.F.1 Faceted Capping +

TYPE NO.	A	B	C
I.F.1.1	215	65.5	42
I.F.1.2*	255	77.5	50

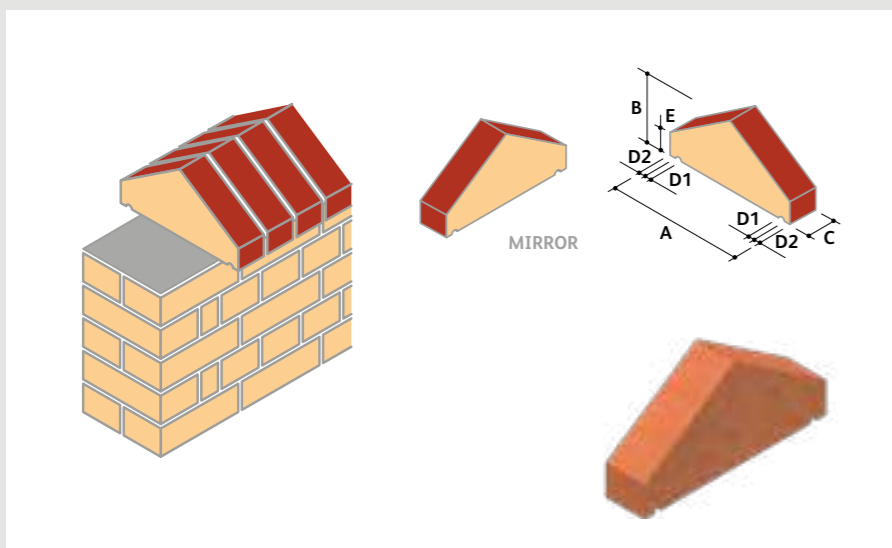

CP.2.1 Saddleback Copping

TYPE NO.	A	B	C	D1	D2	E
CP.2.1	305	153	65	13	15	15

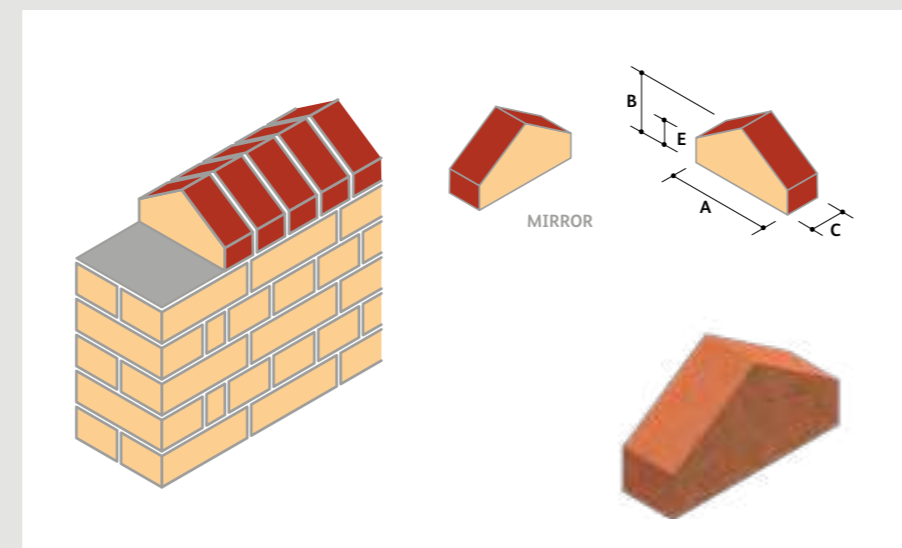

CP.2.2 Saddleback Capping

TYPE NO.	A	B	C	E
CP.2.2	215	123	65	50

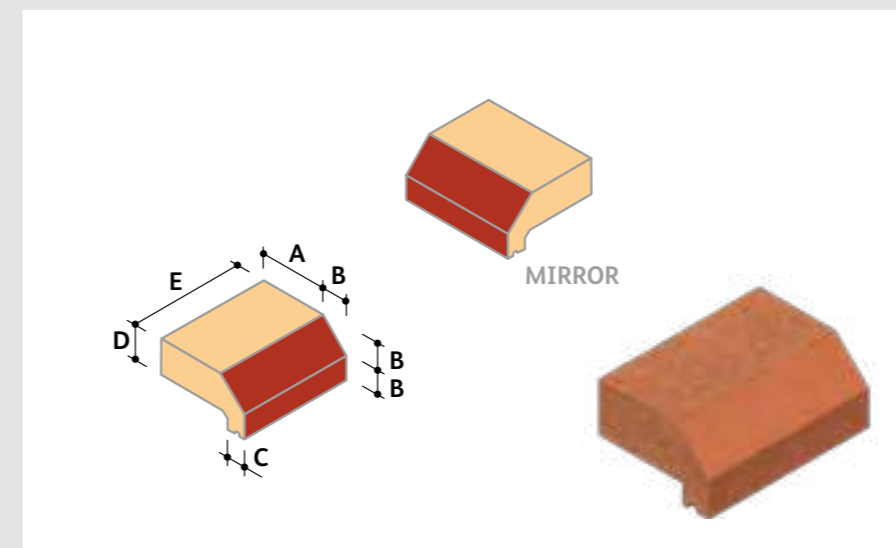

I.B.C.1 Base Copping Standard Brick**

TYPE NO.	A	B	C	D	E
I.B.C.1.1	102	45	35	65	215
I.B.C.1.2*	122	45	35	65	215

SILL BRICKS

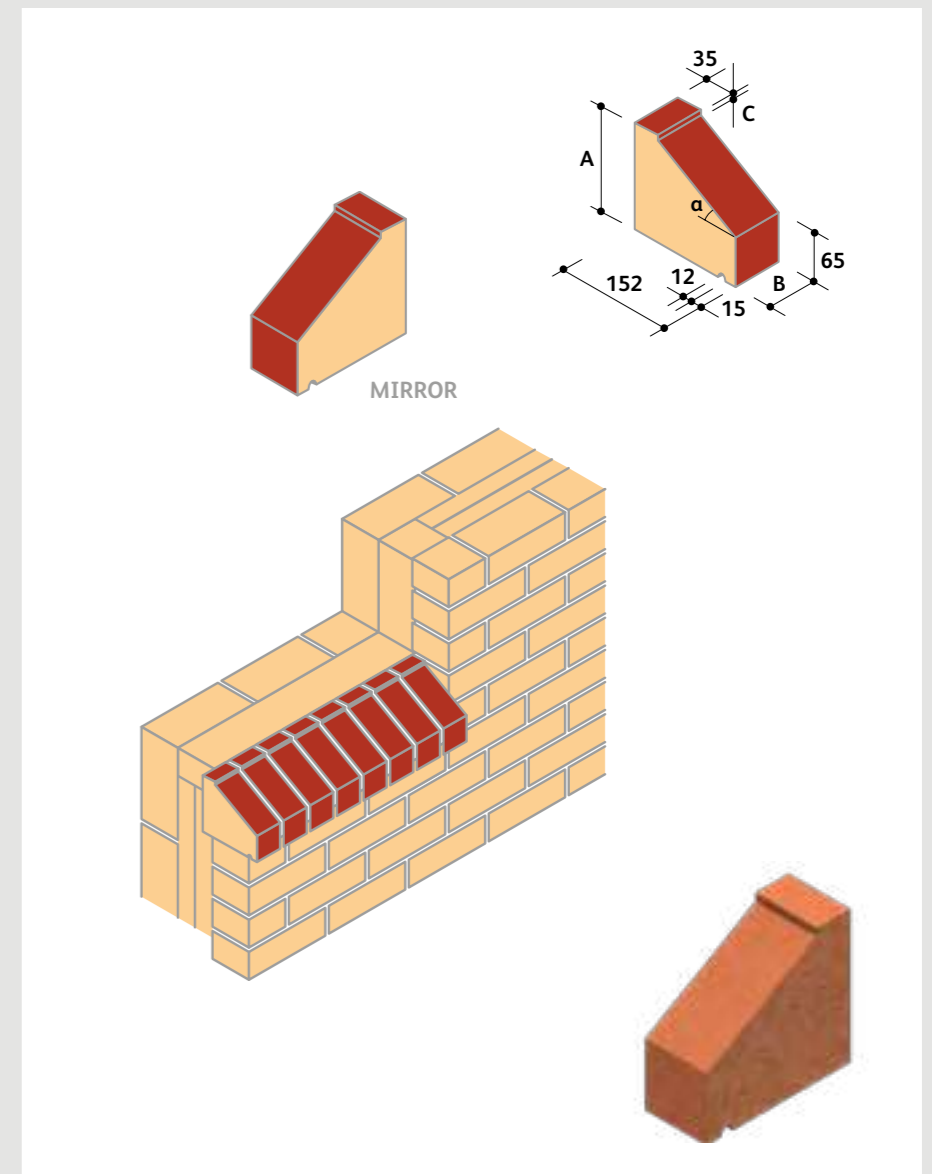

I.C.1 Overhanging Angled Sill

TYPE NO.	A	B	C	α
I.C.1.1	140	65	7.5	30°
I.C.1.2	140	102	7.5	30°
I.C.1.3	140	215	7.5	30°
I.C.1.4	215	65	10	50°
I.C.1.5	215	102	10	50°
I.C.1.6	215	215	10	50°

● To complement the Everyday Range, Istock Kevington provides the perfect design details to finish off corners.
 ■ Cavity wall. † Other widths available. * Extra faces available. ** Can be cut to form incline to transition cut.

ARCH BRICKS

AR.1 Tapered Header

TYPE NO.	UNIT DIMENSIONS				IDEAL SPAN DIMENSION	NO. OF WHOLE BRICKS (SPAN)	NO. OF BRICKS IN SEMI CIRCLE
	A	B	C	D			
AR.1.1	215	102	75	59	910	4	20 or 21
I.AR.1.1-1*	215	102	75	62	1135	5	24 or 25
AR.1.2	215	102	75	64	1360	6	28 or 29
I.AR.1.2-1*	215	102	75	65	1585	7	32 or 33
AR.1.3	215	102	75	66	1810	8	36 or 37
I.AR.1.3-1*	215	102	75	67	2260	10	45 or 46
AR.1.4	215	102	75	69	2710	12	53 or 54

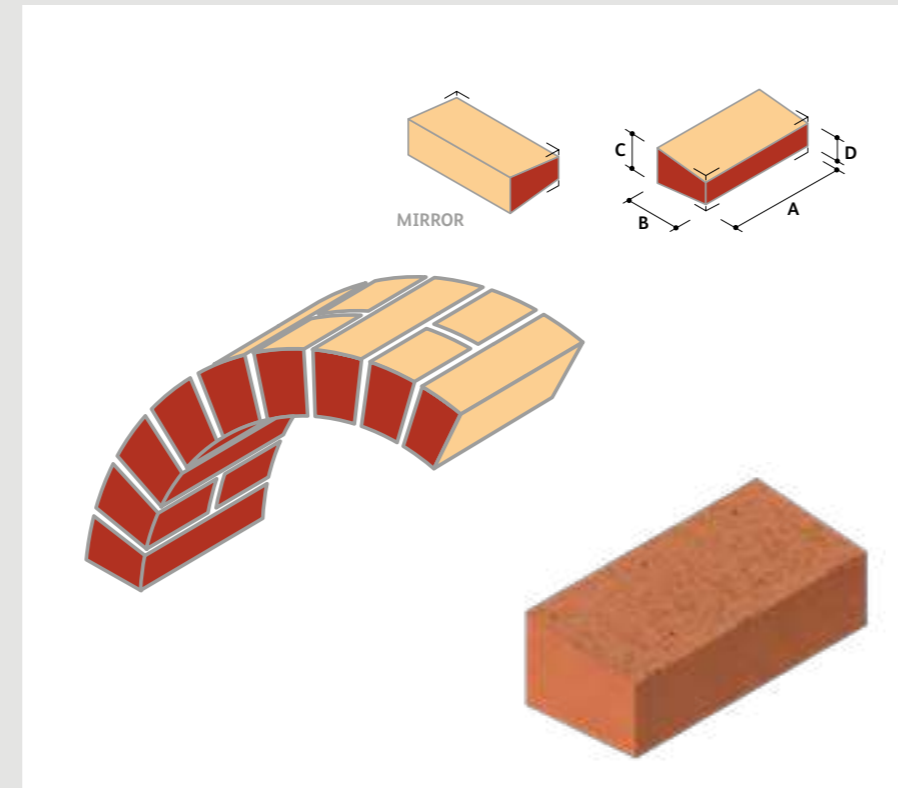

AR.2 Tapered Stretcher

TYPE NO.	UNIT DIMENSIONS				IDEAL SPAN DIMENSION	NO. OF WHOLE BRICKS (SPAN)	NO. OF BRICKS IN SEMI CIRCLE
	A	B	C	D			
AR.2.1	215	102	75	48	910	4	25
I.AR.2.1-1*	215	102	75	51	1135	5	29
AR.2.2	215	102	75	55	1360	6	33
I.AR.2.2-1*	215	102	75	57	1585	7	37
AR.2.3	215	102	75	58	1810	8	41
I.AR.2.3-1*	215	102	75	61	2260	10	50
AR.2.4	215	102	75	63	2710	12	58

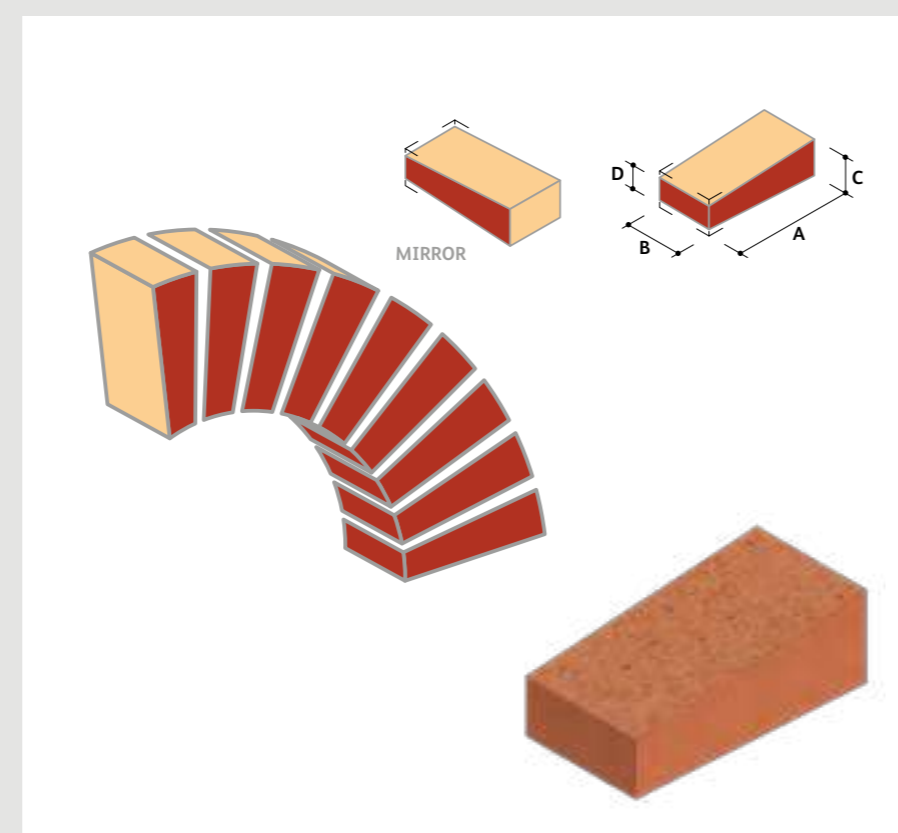

RADIAL BRICKS

RD.1 Radial Header

TYPE NO.	UNIT DIMENSIONS			IDEAL RADIUS		NO. OF BRICKS IN QUADRANT	
	A	B	C	D	OUTER		INNER
RD.1.1	215	108	65	52	450	235	6
RD.1.2	215	108	65	70	675	460	9
RD.1.3	215	108	65	80	900	685	12
I.RD.1.3-1	215	108	65	85	1125	910	15
RD.1.4	215	108	65	89	1350	1135	18
I.RD.1.4-1	215	108	65	94	1800	1585	24
RD.1.5	215	108	65	97	2250	2035	30
I.RD.1.5-1	215	108	65	101	3600	3385	48
RD.1.6	215	108	65	103	5400	5185	72

NOTE: Radial Bricks are normally manufactured flat backed unless specified otherwise.

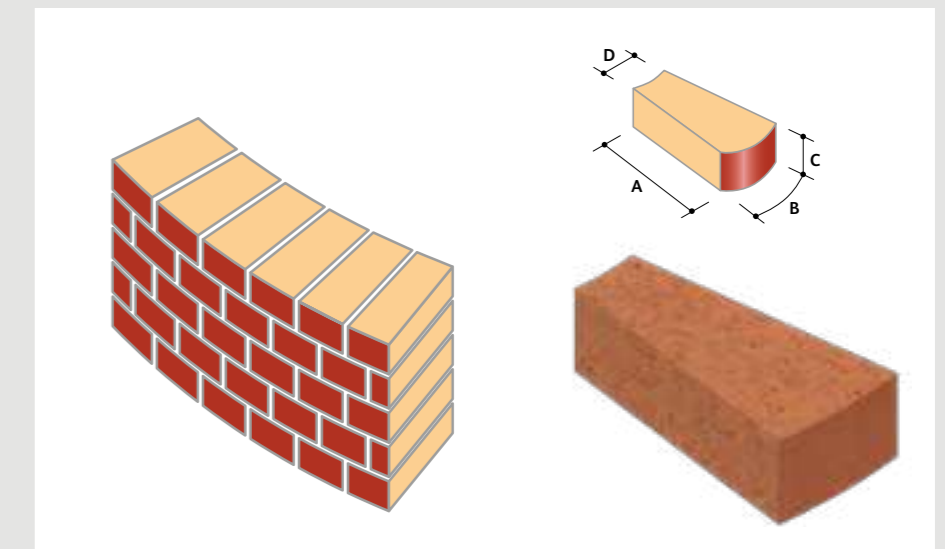

RD.2 Radial Stretcher

TYPE NO.	UNIT DIMENSIONS			IDEAL RADIUS		NO. OF BRICKS IN QUADRANT	
	A	B	C	D	OUTER		INNER
RD.2.1	226	102	65	172	450	347	3
RD.2.2	226	102	65	190	675	572	4.5
RD.2.3	226	102	65	199	900	797	6
I.RD.2.3-1	226	102	65	204	1125	1022	7.5
RD.2.4	226	102	65	208	1350	1247	9
I.RD.2.4-1	226	102	65	212	1800	1697	12
RD.2.5	226	102	65	215	2250	2147	15
I.RD.2.5-1	226	102	65	219	3600	3497	24

NOTE: To be used in conjunction with I.RD.3, radial to straight transition bricks.

NOTE: Radial Bricks are normally manufactured flat backed unless specified otherwise.

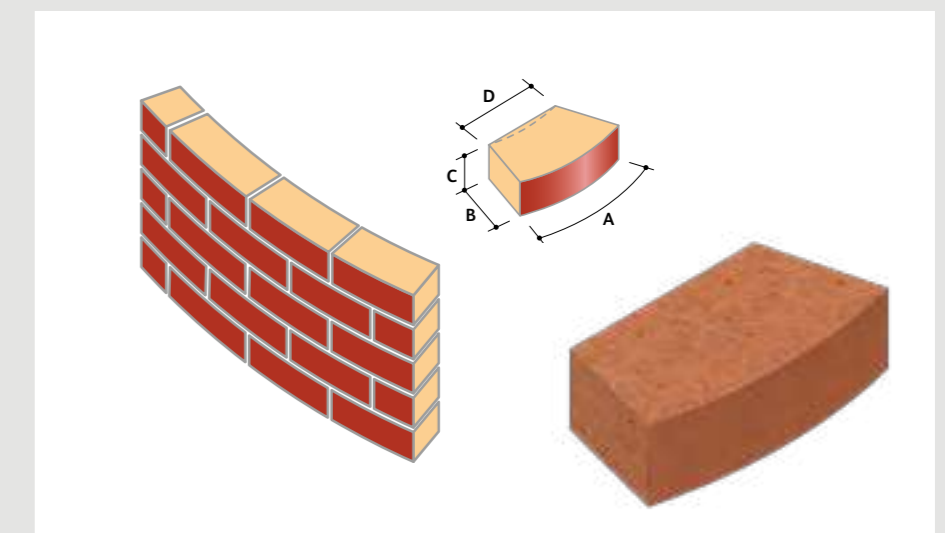

RD.3 Radial Stretcher

TYPE NO.	UNIT DIMENSIONS			IDEAL RADIUS		NO. OF BRICKS IN QUADRANT	
	A	B	C	D	OUTER		INNER
I.RD.3.1	108	102	65	198	450	347	3
I.RD.3.2	108	102	65	204	675	572	4.5
I.RD.3.3	108	102	65	208	900	797	6
I.RD.3.4	108	102	65	211	1125	1022	7.5
I.RD.3.5	108	102	65	212	1350	1247	9
I.RD.3.6	108	102	65	214	1800	1697	12
I.RD.3.7	108	102	65	215	2250	2147	15
I.RD.3.8	108	102	65	217	3600	3497	24

NOTE: To be used in conjunction with I.RD.3, radial to straight transition bricks.

NOTE: Radial Bricks are normally manufactured flat backed unless specified otherwise.

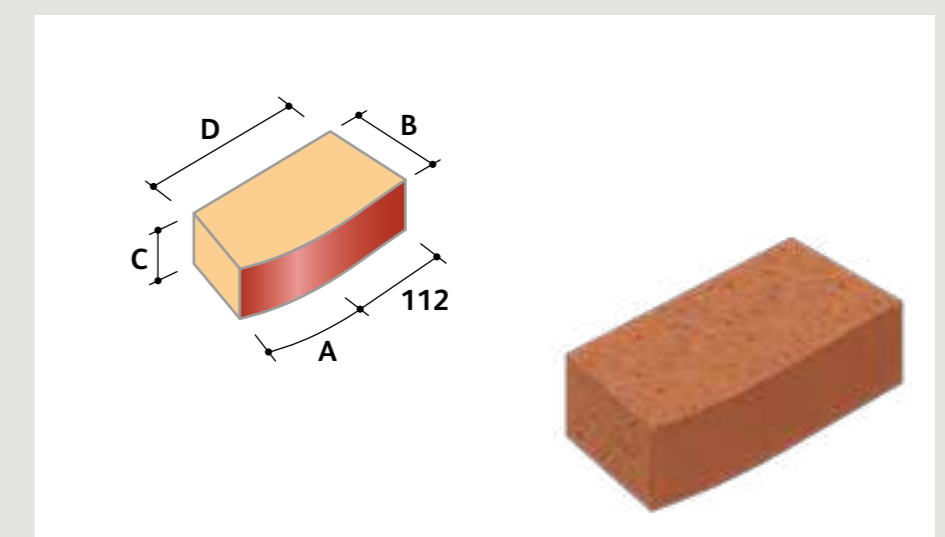

● To complement the Everyday Range, Ibstock Kevington provides the perfect design details to finish off corners.

* Ibstock Specials to create a wider choice of arch spans. Bullnose and Cant profiles are available.

IMAGE: SHEARSTONE COTSWOLD VILLAGE
COTTAGE WALLING STONE, TETBURY, COTSWOLDS

AT THE FOREFRONT OF CONCRETE BUILDING PRODUCTS

Ibstock Concrete comprises of the Forticrete, Supreme, Anderton and Longley concrete brands, covering a range of products including; fencing, roofing, flooring and rail solutions.

Ibstock is a leading manufacturer and supplier of **concrete building products** to customers in the UK residential construction sector.

For more information on the full range of products and services offered by Ibstock Concrete, which includes the Forticrete, Supreme, Anderton and Longley brands, please visit: www.ibstockplc.co.uk



Rail solutions



- ✓ Widest range of complementary precast products into the UK Rail Industry
- ✓ Lightweight and fire-resistant cable troughing systems, signal bases, ballast boards, posts and more
- ✓ Manufactured in the UK – Network Rail approved.



Fence posts



- ✓ Strong and durable
- ✓ Smooth surface finish
- ✓ Pyramid at one end and a bobble top at the other, giving the option of which is visible on the finished fence.



Roof tiles



- ✓ Durable and lightweight
- ✓ Authentic appearance and affordable
- ✓ Innovative **SL8** and **PAN8** roof tiles boast superior coverage whilst **Gemini** gives the appearance of traditional plain tiles.



Floor beams



- ✓ Highly practical solution
- ✓ For ground and upper floors
- ✓ Quick and easy to install in all weather conditions without the need for special skills.



Cast Stone



- ✓ Wide range of standard profiles of semi-dry cast stone products which replicate the traditions of natural stone
- ✓ No compromise to aesthetic appeal
- ✓ Unrivalled quality.

Code	Product	Colour/Texture	Page
ALDRIDGE			
0270	Aldridge Multi Rustic		25
0270	Aldridge Multi Rustic 73mm ‡		25
0272	Aldridge Smooth Red		27
0272	Aldridge Smooth Red 73 mm ‡		27
0257	Anglian Red Multi Rustic		36
0257	Anglian Red Multi Rustic 73mm ‡		36
0352	Anglian Red Rustic		26
0352	Anglian Red Rustic 73mm ‡		26
0356	Anglian Ruskin Multi 73mm		36
0269	New Burntwood Red Rustic		35
0269	New Burntwood Red Rustic 73mm ‡		35
0256	Ruskin Red 73mm		35
0289	Staffordshire Multi Rustic		36
0289	Staffordshire Multi Rustic 73mm ‡		36
0258	Anglian Beacon Sahara		48
0258	Anglian Beacon Sahara 73mm ‡		48
0353	Anglian Buff Multi Rustic		49
0354	Himley Ebony Black		52
0355	Himley Dark Brown Rustic		56
0358	Himley Ash Grey		60
ASHDOWN			
A4009A	Bexhill Dark		33
A4033A	Bexhill Purple Multi		31
A4010A	Bexhill Red		34
A4001A	Cottage Mixture		32
A4027A	Coleridge Yellow Multi		47
A4053A	Funton Old Chelsea Yellow		46
A4002A	Crowborough Multicoloured Stock		59

Code	Product	Colour/Texture	Page
BIRTLEY			
2601	Beamish Blend		31
2602	Birtley Olde English		31
2602	Birtley Olde English 73mm ‡		31
2631	Borrowdale Blend		31
2611	Commercial Red		23
2611	Commercial Red 73mm ‡		23
2629	Cumberland Blend		31
2622	Northumbrian Cottage		23
2621	Otterburn Antique		24
2623	Townhouse Blend		31
2613	Warwickshire Olde English		24
2605	Birtley Olde English Buff		46
2630	Millhouse Blend		46
2618	Northern Buff		46
2634	Birtley Brown		56
2640	Olde English Grey		59
NA2601A	Beamish Blend		63
NA2634A	Brown Waterstruck		62
NA2611A	Commercial Red		63
NA2602A	Olde English		63
NF2605A	Olde English Buff		63
NB2640A	Olde English Grey		63
NA2623A	Townhouse Blend		62
CATTYBROOK			
A0661A	Bridgwater Weathered Red		27
A0655A	Bristol Mixed Red		36
A0656A	Bristol Orange Blend		38
A0630A	Bristol Red		26
A0635A	Brunswick Antique Red		26
A0636A	Brunswick Farmhouse Mixture		26

Code	Product	Colour/Texture	Page
CATTYBROOK			
A0637A	Brunswick Red		28
A0610A	Cheddar Red		28
A0618A	Tradesman Rustic Blend		26
A0605A	Tradesman Tudor Regent		26
A0662A	Westbrick Red Purple Multi		36
A0657A	Bristol Buff Multi		49
A0634A	Bristol Gold		42
A0638A	Brunswick Autumn		49
A0640A	Brunswick Buff		42
A0643A	Brunswick Wilton Yellow		49
A0611A	Cheddar Golden		43
A0619A	Tradesman Buff Multi		48
A0620A	Tradesman Millgate Buff		49
A0628A	Bristol Brown		56
A0612A	Cheddar Brown		56
A0642A	Brunswick Tryfan Grey		60
CHAILEY			
A4528A	Chailey Medium Multi Stock		32
A4517A	Hamsey Mixed Stock		34
A4514A	New Chailey Rustic Stock		35
A4501A	New Chailey Stock		33
A4527A	Cooksbridge Rustic Blend		47
A4512A	Cooksbridge Yellow Clamp Stock		47
CHESTERTON			
2947	Alderley Burgundy		38
2977	Alderley Cottage Blend		36
2948	Alderley Mixture		36
2946	Alderley Orange		28
2978	Alderley Russet Blend		38
2905	Etruria Mixture		37

Code	Product	Colour/Texture	Page
CHESTERTON			
2965	Grampian Red		27
2967	Grampian Red Mixture		37
2922	Hanchurch Mixture		36
2916	Hollington Blend		27
2933	Manorial Mixture		37
2902	Manorial Red		26
2919	Mercia Antique		37
2974	Mercia Orange		29
2976	Mercia Orange Multi		36
2934	Multi Red Smooth		38
2949	Tradesman Heather Mixture		36
2949	Tradesman Heather Mixture 73mm †		36
0314	Tradesman Antique Grey		60
2693	Tradesman Light		60
CLERKENWELL			
A5168A	Chorlton		43
A5149A	Continental Buff		43
A5171A	Finnieston		43
A5091A	Finnieston Smooth		44
A5162A	Moseley		42
A5143A	New Diana		44
A5172A	Romsey		42
A5145A	White Engobe		44
A5084A	Winster		44
A5144A	Black Smooth		51
A5170A	Clapton		51
A5093A	Clapton Blue Black		52
A5087A	Emral		52
A5092A	Jericho Smooth		52

Code	Product	Colour/Texture	Page
CLERKENWELL			
A5166A	Jericho Textured		52
A5089A	Caldey		58
A5163A	Clifton		59
A5088A	Coledale		58
A5146A	Dark Grey		58
A5086A	Gowan		58
A5085A	Kensy		58
A5147A	Light Grey		58
A5164A	Montpelier		58
A5169A	Partick		58
NE5082A	Barra		62
NJ5080A	Bryher		63
NH5076A	Harris		63
NE5073A	Lewis		62
NE5079A	Lundy		62
NE5078A	Samson		63
NE5072A	Sanday		63
NE5077A	Stronsay		63
NE5081A	Tresco		63
AQUAMARINE	Aqua Marine Glazed		65
BLACK	Black Glazed		66
BLUEBIRD	Blue Bird Glazed		66
BLUE	Blue Glazed		66
BOTTLEGREEN	Bottle Green Glazed		67
BUCKINGHAM	Buckingham Glazed		67
RED	Burgundy Red Glazed		68
CONIFER	Conifer Glazed		67
CONKER	Conker Glazed		68
COPPER	Copper Glazed		67

Code	Product	Colour/Texture	Page
CLERKENWELL			
CREAM	Cream Glazed		65
DARKGREY	Dark Grey Glazed		66
DARKSALMON	Dark Salmon Glazed		68
GARLAND	Garland Glazed		65
IODINE	Iodine Glazed		66
JADE	Jade Glazed		67
LEMON	Lemon Glazed		65
LIGHTGREY	Light Grey Glazed		65
LIME	Lime Glazed		65
LONDONWHITE	London White Glazed		65
MIDBLUE	Mid Blue Glazed		66
MINT	Mint Glazed		67
NAVYBLUE	Navy Blue Glazed		65
GREEN	Olive Green Glazed		67
PEWTER	Pewter Glazed		68
PLUM	Plum Glazed		68
ROYALBLUE	Royal Blue Glazed		66
SATINGREY	Satin Grey Glazed		68
SATINSKYBLUE	Satin Sky Blue Glazed		66
SKYBLUE	Sky Blue Glazed		66
TOFFEE	Toffee Glazed		68
WHITE	White Glazed		65
YELLOW	Yellow Glazed		65
DORKET HEAD			
A2405A	Balmoral		39
A2431A	Cavendish Dorket Fireglow		37
A2478A	Hardwicke Oakham Blend		37
A2417A	Hardwicke Sherwood Blaze		40
A2426A	Hardwicke Welbeck Autumn Antique		37

Code	Product	Colour/Texture	Page
DORKET HEAD			
A2423A	Hardwicke Welbeck Red Mixture		40
A2407A	Windsor		40
A2434A	Cavendish Dorket Honeygold		49
A2428A	Hardwicke Minster Beckstone Mixture		49
A2419A	Hardwicke Minster Cream Blend		43
A2418A	Hardwicke Minster Sandstone Mixture		49
A2406A	Sandringham		43
ECLIPSE			
A0825A	Ivanhoe Westminster		34
A0812A	Leicester Multi Red Stock		34
A0802A	Leicester Red Stock		24
A0834A	Leicester Weathered Multi		32
A0813A	Leicester Weathered Red Stock		32
A0803A	Gault Cream Stock		42
A0189A	Leicester Multi Cream Stock		48
A0805A	New Ivanhoe Cream		47
ELISTOWN			
A4985A	Arden Olde Farmhouse Original		25
A4980A	Arden Red		25
A4982A	Arden Weathered Red		34
A4941A	Dorset Multi Red Stock		33
A4932A	Dorset Red Stock		24
A4989A	Heritage County Blend		25
A4977A	Heritage Light Red Multi		34
A4986A	Heritage Red Blend		24
A4937A	Leicester Autumn Multi		33
A4946A	Leicester Orange Stock		25
A4935A	Leicester Weathered Multi		35
A4947A	Rustique Blend		34
A4979A	Arden Grey		60

Code	Product	Colour/Texture	Page
ELISTOWN			
A4990A	Arden Weathered Grey		59
A4978A	Leicester Grey Stock		59
A4933A	Leicester Weathered Grey Stock		59
LAYBROOK			
0771	Berkshire Orange Stock		25
0717	Capital Multi Stock		35
0767	Cissbury Red Multi Stock		32
0773	Laybrook Flame Red Stock Paver		70
0756	Laybrook Imperial Red Stock		24
0772	Laybrook Multi Orange Stock		33
0727	Laybrook Red Multi Stock Paver		70
0773	Laybrook SUDS Flame Red Stock Paver		70
0726	Laybrook SUDS Multi Stock Paver		70
0727	Laybrook SUDS Red Multi Stock Paver		70
0708	Parham Red Stock		24
0700	Petworth Multi Stock		34
0709	Thakeham Red Multi Stock		32
A0713A	Arundel Yellow Multi Stock		46
A0730A	Sevenoaks Yellow Stock		46
A0714A	Capital Brown Multi Stock		56
NA0708A	Parham Red Stock		62
LEICESTER			
0020	Bradgate Red		24
0031	Bradgate Claret		31
0021	Bradgate Regal		32
0176	Grosvenor Autumn Flame		34
0149	Grosvenor County Mixture		35
0060	Ivanhoe Antique		31
0055	Ivanhoe Cottage Blend		32
0059	Ivanhoe Katrina Multi		31

Code	Product	Colour/Texture	Page
LEICESTER			
0058	Ivanhoe Mellow Red		33
0062	Ivanhoe Olde Village		34
0103	Amato Blend		48
0023	Bradgate Golden Purple		47
0028	Bradgate Harvest Antique		46
0025	Bradgate Light Buff		42
0030	Bradgate Multi Cream		42
0101	Bruges Blend		47
0102	Dinian Blend		47
0104	Floriana Blend		48
0061	Ivanhoe Athena Blend		46
0054	Ivanhoe Cream Original		47
A0083A	Niveus		47
0032	Bradgate Medium Grey		59
A0090A	Albus		60
A0079A	Tenebris		59
LODGE LANE			
2249	Atlas Smooth Blue		54
A2213A	Riven Blue		54
A2214A	Riven Brindle		54
2221	Staffordshire Blue Brindle Dragface		54
2220	Staffordshire Blue Brindle Smooth		54
2232	Staffordshire Slate Blue Smooth		54
2232	Staffordshire Slate Blue Smooth 73mm ‡		54
NA2206A	Natural Blue Smooth Linear		62
NA2207A	Natural Blue Riven Textured Linear		62
PARKHOUSE			
3022	Audley Red Mixture Stock		33
3058	Betley Cottage Blend		34
3035	Lambourn Orange Multi Stock		34

Code	Product	Colour/Texture	Page
PARKHOUSE			
3025	Mellow Ashridge Stock		25
3010	Mellow Regent Stock		25
3018	New Cavendish Stock		24
3057	New Sandhurst Stock		24
3055	Weston Red Multi Stock		33
3016	Marlborough Stock		42
RAVENHEAD			
3577	Calderstone Claret		38
3578	Calderstone Russett		27
3541	Cheshire Weathered		39
3596	Chester Red Blend		28
3516	Hearted Red Rustic		27
3527	Oakleigh Red Blend		36
3532	Oldcott Rustic		29
3518	Ormonde Antique Blend		37
3594	Pre War Common		39
3615	Ramian Red Multi Stock		33
3613	Ramian Red Stock Blend		33
3616	Ramian Red Stock		33
3502	Ravenhead Red Rustic		28
3501	Ravenhead Red Smooth		28
3501	Ravenhead Red Smooth 73mm ‡		28
3579	Roughdales Red Multi Rustic		40
3536	Smooth Village Mixture		29
3598	Tradesman Common		39
3542	Tradesman Light Rustic Blend		39
3576	Trafford Multi Rustic		40
3509	Worsley Weathered		40
3611	Ramian Buff Multi Stock		47

Code	Product	Colour/Texture	Page
RAVENHEAD			
3614	Ramian Buff Stock Blend		47
3612	Ramian Buff Stock		47
3505	Bracken Brown Rustic		56
SOUTH HOLMWOOD			
4102	Dorking Multi		27
4125	Dorking Red		28
4157	Holmwood Natural		29
4145	Reigate Medium Multi		38
4148	Reigate Purple		38
4132	Surrey County Red		28
4152	Surrey Damson Multi		35
4143	Surrey Light Multi		37
4131	Surrey Orange		29
4133	Surrey Red Multi		38
4136	Surrey Russet		36
4149	Holbrook Sandfaced Black		51
4120	Holbrook Sandfaced Dark		51
4119	Holbrook Sandfaced Brown		56
PARKHOUSE			
4355	Kingston Handmade Heather Red		23
4355	Kingston Handmade Heather Red Imperial ‡		23
4357	Kingston Handmade Light Red		23
4357	Kingston Handmade Light Red Imperial ‡		23
4356	Kingston Handmade Light Red Multi		31
4356	Kingston Handmade Light Red Multi Imperial		31
4354	Kingston Handmade Restoration Red		23
4354	Kingston Handmade Restoration Red Imperial ‡		23
4301	Swanage Handmade Heather Red		23
4302	Swanage Handmade Light Red		23

Code	Product	Colour/Texture	Page
PARKHOUSE			
4302	Swanage Handmade Light Red 50mm ‡		23
4303	Swanage Handmade Light Red Multi		31
4312	Swanage Handmade Restoration Red		23
4312	Swanage Handmade Restoration Red 50mm ‡		23
4317	Swanage Imperial Light Stock 68mm		24
4316	Swanage Imperial Red Stock 68mm		24
THROCKLEY			
2801	Alnwick Blend		39
2764	Callerton Weathered Red 73mm		36
2802	Chillingham Blend		39
2769	Grainger Antique		26
2770	Grainger Autumn		29
2709	Hadrian Red		29
2767	Kilcreggan Multi Wirecut		38
2703	Mixed Red Textured		27
2804	Morpeth Blend		37
2724	Throckley Old English		27
2800	Wylam Olde Blend		39
2803	Dilston Blend		48
2771	Grainger Gold		49
2708	Hadrian Buff		42
2760	Mixed Buff Rustic		42
2715	Oatmeal Textured		42
2731	Sandalwood		42
2712	Smooth Buff		43
2738	Stuart Buff		43
2790	Tay Buff Multi		48
2775	Milburn Ashen Brown Blend		56

Brick Code	Product Name	Factory	Page	Durability	Active Soluble Salts	Compressive Strength N/mm ² (>)	Water Absorbtion % (<)	Size Tolerance mean	Size Tolerance Range	Pack Quantity	Maximum Load Size*	Brick Height mm	Dry Brick Weight Kg	Packaging
A														
A0090A	Albus	Leicester	60	F2	S2	20	20	T2	R1	430	14190	65	2	Banded (plastic) and shrinkwrapped
A2947A	Alderley Burgundy	Chesterton	38	F2~	S2	60	10	T2	R1	500	12500	65	2.4	Banded (plastic) and shrinkwrapped
A2977A	Alderley Cottage Blend	Chesterton	36	F2~	S2	60	7	T2	R1	500	12500	65	2.3	Banded (plastic) and shrinkwrapped
A2948A	Alderley Mixture	Chesterton	36	F2~	S2	60	7	T2	R1	500	12500	65	2.4	Banded (plastic) and shrinkwrapped
A2946A	Alderley Orange	Chesterton	28	F2~	S2	60	7	T2	R1	500	12500	65	2.4	Banded (plastic) and shrinkwrapped
A2978A	Alderley Russet Blend	Chesterton	38	F2~	S2	60	7	T2	R1	500	11500	65	2.3	Banded (plastic) and shrinkwrapped
A0270A	Aldridge Multi Rustic	Aldridge	25	F2	S2	35	12	T2	R1	316	12240	65	2.2	Banded (plastic)
A0272A	Aldridge Smooth Red	Aldridge	27	F2~	S2	60	9	T2	R1	400	10112	65	2.3	Banded (plastic)
A2801A	Alnwick Blend	Throckley	39	F2~	S2	60	10	T2	R1	500	12000	65	2.3	Banded (plastic) and shrinkwrapped
A0103A	Amato Blend	Leicester	48	F2	S2	15	25	T2	R1	430	14190	65	2	Banded (plastic) and shrinkwrap caps
A0258A	Anglian Beacon Sahara	Aldridge	48	F2	S2	45	12	T2	R1	316	12240	65	2.1	Banded (plastic)
A0353A	Anglian Buff Multi Rustic	Aldridge	49	F2	S2	45	12	T2	R1	316	12240	65	2.1	Banded (plastic)
A0257A	Anglian Red Multi Rustic	Aldridge	36	F1	S2	25	13	T2	R1	316	12240	65	2.1	Banded (plastic)
A0352A	Anglian Red Rustic	Aldridge	26	F1	S2	25	13	T2	R1	316	11288	65	2.1	Banded (plastic)
C0356A	Anglian Ruskin Multi 73mm	Aldridge	35	F2	S2	35	12	T2	R1	292	11288	73	2.5	Banded (plastic)
KGB-AQUAMARINE	Aqua Marine Glazed	Clerkenwell	65	F2	S2	125	4.5	T2	R2	364	8736	65	2.7	Shrinkwrapped on pallets (wood)
A4979A	Arden Grey	Ellistown	60	F2	S2	20	22	T2	R1	500	13500	65	2.1	Banded (plastic) and shrinkwrapped
A4985A	Arden Olde Farmhouse Original	Ellistown	25	F2	S2	20	19	T2	R1	500	12500	65	2.2	Banded (plastic) and shrinkwrapped
A4980A	Arden Red	Ellistown	25	F2	S2	20	19	T2	R1	500	12500	65	2.2	Banded (plastic) and shrinkwrapped
A4990A	Arden Weathered Grey	Ellistown	59	F2	S2	20	22	T2	R1	500	13500	65	2.1	Banded (plastic) and shrinkwrapped
A4982A	Arden Weathered Red	Ellistown	34	F2	S2	20	19	T2	R1	500	12500	65	2.2	Banded (plastic) and shrinkwrapped
A0713A	Arundel Yellow Multi Stock	Laybrook	46	F2	S2	25	14	T2	R1	475	11875	65	2.3	Banded (plastic)
A2249A	Atlas Smooth Blue	Lodge Lane	54	F2~	S2	75	7	T2	R1	380	11400	65	2.4	Banded (plastic)
A3022A	Audley Red Mixture Stock	Parkhouse	33	F2	S2	15	13	T2	R1	500	10500	65	2.5	Banded (plastic)
B														
A2405A	Balmoral	Dorket Head	39	F2	S2	40	16	T2	R1	475	13775	65	2	Banded (plastic) and shrinkwrapped
NE5082A	Barra	Clerkenwell	62	F2	S2	12.5	22	T2	R1	440	On Request	40	On Request	On Request
A2601A	Beamish Blend	Birtley	31	F2	S2	20	12	Tm	Rm	392	11312	65	2.7	Banded (plastic) and shrinkwrapped
NA2601A	Beamish Blend	Birtley	63	F2	S2	20	12	Tm	Rm	192	11312	65	5.6	Shrinkwrapped on pallets
A0771A	Berkshire Orange Stock	Laybrook	25	F2	S2	25	14	T2	R1	475	11875	65	2.3	Banded (plastic)
A3058A	Betley Cottage Blend	Parkhouse	34	F2	S2	15	13	T2	R1	500	10500	65	2.5	Banded (plastic)
A4009A	Bexhill Dark	Ashdown	33	F2	S2	30	15	T1	R1	500	12500	65	2.3	Banded (plastic)
A4033A	Bexhill Purple Multi	Ashdown	31	F2	S2	30	15	T1	R1	500	12500	65	2.2	Banded (plastic)
A4010A	Bexhill Red	Ashdown	34	F2	S2	30	15	T1	R1	500	12500	65	2.2	Banded (plastic)

Brick Code	Product Name	Factory	Page	Durability	Active Soluble Salts	Compressive Strength N/mm ² (>)	Water Absorbtion % (<)	Size Tolerance mean	Size Tolerance Range	Pack Quantity	Maximum Load Size*	Brick Height mm	Dry Brick Weight Kg	Packaging
B														
A2634A	Birtley Brown	Birtley	56	F2	S2	20	12	Tm	Rm	392	10976	65	2.7	Banded (plastic) and shrinkwrapped
A2602A	Birtley Olde English	Birtley	31	F2	S2	20	12	Tm	Rm	392	10976	65	2.7	Banded (plastic) and shrinkwrapped
A2605A	Birtley Olde English Buff	Birtley	46	F2	S2	20	12	Tm	Rm	392	10976	65	2.7	Banded (plastic) and shrinkwrapped
KGB-BLACK	Black Glazed	Clerkenwell	68	F2	S2	125	4.5	T2	R2	364	8736	65	2.7	Shrinkwrapped on pallets (wood)
A5144A	Black Smooth	Clerkenwell	51	F2	S2	40	6	T2	R2	468	On Request	65	2.5	Banded (plastic)
KGB-BLUEBIRD	Blue Bird Glazed	Clerkenwell	66	F2	S2	125	4.5	T2	R2	364	8736	65	2.7	Shrinkwrapped on pallets (wood)
KGB-BLUE	Blue Glazed	Clerkenwell	66	F2	S2	125	4.5	T2	R2	364	8736	65	2.7	Shrinkwrapped on pallets (wood)
A2631A	Borrowdale Blend	Birtley	31	F2	S2	20	12	Tm	Rm	404	10976	65	2.7	Banded (plastic) and shrinkwrapped
KGB-BOTTLEGREEN	Bottle Green Glazed	Clerkenwell	67	F2	S2	125	4.5	T2	R2	364	8736	65	2.7	Shrinkwrapped on pallets (wood)
A3505A	Bracken Brown Rustic	Ravenhead	56	F2	S2	60	9	T2	R1	500	12500	65	2.3	Banded (plastic)
A0031A	Bradgate Claret	Leicester	31	F2	S2	20	19	T2	R1	430	12040	65	2.1	Banded (plastic) and shrinkwrap caps
A0023A	Bradgate Golden Purple	Leicester	47	F2	S2	20	20	T2	R1	430	14190	65	2	Banded (plastic) and shrinkwrap caps
A0028A	Bradgate Harvest Antique	Leicester	46	F2	S2	20	20	T2	R1	430	14190	65	2	Banded (plastic) and shrinkwrap caps
A0025A	Bradgate Light Buff	Leicester	42	F2	S2	15	25	T2	R1	430	14190	65	2	Banded (plastic) and shrinkwrap caps
A0032A	Bradgate Medium Grey	Leicester	59	F2	S2	20	20	T2	R1	430	14190	65	2	Banded (plastic) and shrinkwrap caps
A0030A	Bradgate Multi Cream	Leicester	42	F2	S2	15	25	T2	R1	430	14190	65	2	Banded (plastic) and shrinkwrap caps
A0020A	Bradgate Red	Leicester	24	F2	S2	20	19	T2	R1	430	12470	65	2.1	Banded (plastic) and shrinkwrap caps
A0021A	Bradgate Regal	Leicester	32	F2	S2	20	19	T2	R1	430	12470	65	2.1	Banded (plastic) and shrinkwrap caps
A0661A	Bridgwater Weathered Red	Cattybrook	27	F2	S2	50	10	T2	R1	500	11500	65	2.4	Banded (plastic)
A0628A	Bristol Brown	Cattybrook	56	F2	S2	50	10	T2	R1	500	11500	65	2.4	Banded (plastic)
A0657A	Bristol Buff Multi	Cattybrook	49	F2	S2	50	12	T2	R1	500	12000	65	2.2	Banded (plastic)
A0634A	Bristol Gold	Cattybrook	42	F2	S2	50	12	T2	R1	500	12000	65	2.2	Banded (plastic)
A0655A	Bristol Mixed Red	Cattybrook	36	F2	S2	50	10	T2	R1	500	11500	65	2.4	Banded (plastic)
A0656A	Bristol Orange Blend	Cattybrook	38	F2	S2	50	10	T2	R1	500	11500	65	2.4	Banded (plastic)
A0630A	Bristol Red	Cattybrook	26	F2	S2	50	10	T2	R1	500	11500	65	2.4	Banded (plastic)
NA2634A	Brown Waterstruck	Birtley	62	F2	S2	20	12	Tm	Rm	192	10976	65	5.6	Shrinkwrapped on pallets
A0101A	Bruges Blend	Leicester	47	F2	S2	15	25	T2	R1	430	14190	65	2	Banded (plastic) and shrinkwrap caps
A0635A	Brunswick Antique Red	Cattybrook	26	F2	S2	50	10	T2	R1	500	11500	65	2.4	Banded (plastic)
A0638A	Brunswick Autumn	Cattybrook	48	F2	S2	50	12	T2	R1	500	12000	65	2.2	Banded (plastic)
A0640A	Brunswick Buff	Cattybrook	42	TBC	S2	50	12	T2	R1	500	12000	2.2	2.2	Banded (plastic)
A0636A	Brunswick Farmhouse Mixture	Cattybrook	26	F2	S2	50	10	T2	R1	500	11500	65	2.4	Banded (plastic)
A0637A	Brunswick Red	Cattybrook	28	F2	S2	50	10	T2	R1	500	11500	65	2.4	Banded (plastic)
A0642A	Brunswick Tryfan Grey	Cattybrook	60	F2	S2	50	12	T2	R1	500	12000	65	2.2	Banded (plastic)
A0643A	Brunswick Wilton Yellow	Cattybrook	49	F2	S2	50	12	T2	R1	500	12000	65	2.2	Banded (plastic)

*May be lower for a crane off-load vehicle

Brick Code	Product Name	Factory	Page	Durability	Active Soluble Salts	Compressive Strength N/mm ² (>)	Water Absorbtion % (<)	Size Tolerance mean	Size Tolerance Range	Pack Quantity	Maximum Load Size*	Brick Height mm	Dry Brick Weight Kg	Packaging
B														
NJ5080A	Bryher	Clerkenwell	63	F2	S2	70	5	T2	R1	550	On Request	28	On Request	On Request
KGB-BUCKINGHAM	Buckingham Glazed	Clerkenwell	67	F2	S2	125	4.5	T2	R2	364	8736	65	2.7	Shrinkwrapped on pallets (wood)
KGB-RED	Burgundy Red Glazed	Clerkenwell	68	F2	S2	125	4.5	T2	R2	364	8736	65	2.7	Shrinkwrapped on pallets (wood)
C														
A3577A	Calderstone Claret	Ravenhead	38	F2	S2	60	9	T2	R1	500	12500	65	2.3	Banded (plastic)
A3578A	Calderstone Russett	Ravenhead	27	F2	S2	60	9	T2	R1	500	12500	65	2.3	Banded (plastic)
A5089A	Caldew	Clerkenwell	58	F2	S2	40	6	T2	R2	520	On Request	65	2.5	Shrinkwrapped on pallets (wood)
C2764A	Callerton Weathered Red 73mm	Throckley	36	F2~	S2	60	10	T2	R1	424	11040	73	2.7	Banded (plastic) and shrinkwrapped
A0714A	Capital Brown Multi Stock	Laybrook	56	F2	S2	25	14	T2	R1	475	11875	65	2.3	Banded (plastic)
A0717A	Capital Multi Stock	Laybrook	35	F2	S2	25	14	T2	R1	475	12350	65	2.3	Banded (plastic)
A2431A	Cavendish Dorket Fireglow	Dorket Head	37	F1	S2	40	16	T2	R1	475	13775	65	1.9	Banded (plastic) and shrinkwrapped
A2434A	Cavendish Dorket Honeygold	Dorket Head	49	F1	S2	40	16	T2	R1	475	13775	65	1.9	Banded (plastic) and shrinkwrapped
A4528A	Chailey Medium Multi Stock	Chailey	32	F2	S2	12.5	12	T1	R1	370	12210	65	2.2	Banded (plastic)
A0612A	Cheddar Brown	Cattybrook	56	F2	S2	50	10	T2	R1	500	11500	65	2.4	Banded (plastic) and shrinkwrapped
A0611A	Cheddar Golden	Cattybrook	43	F2~	S2	50	12	T2	R1	500	11500	65	2.4	Banded (plastic) and shrinkwrapped
A0610A	Cheddar Red	Cattybrook	28	F2	S2	75	7	T2	R1	500	10500	65	2.5	Banded (plastic) and shrinkwrapped
A3541A	Cheshire Weathered	Ravenhead	39	F2	S2	50	12	T2	R1	500	12500	65	2.2	Banded (plastic)
A3596A	Chester Red Blend	Ravenhead	28	F2	S2	60	9	T2	R1	500	12500	65	2.2	Banded (plastic)
A2802A	Chillingham Blend	Throckley	39	F2~	S2	60	10	T2	R1	500	12000	65	2.3	Banded (plastic) and shrinkwrapped
A5168A	Chorlton	Clerkenwell	43	TBC	S2	40	6	T2	R2	520	TBC	1.6	1.6	Shrinkwrapped on pallets (wood)
A0767A	Cissbury Red Multi Stock	Laybrook	32	F2	S2	25	14	T2	R1	475	11875	65	2.3	Banded (plastic)
A5170A	Clapton	Clerkenwell	51	F2	S2	40	6	T2	R2	468	On Request	65	2.5	Shrinkwrapped on pallets (wood)
A5093A	Clapton Blue Black	Clerkenwell	52	F2	S2	40	6	T2	R2	468	On Request	65	2.5	Shrinkwrapped on pallets (wood)
A5163A	Clifton	Clerkenwell	59	F2	S2	40	6	T2	R2	468	On Request	65	2.5	Shrinkwrapped on pallets (wood)
A5088A	Coledale	Clerkenwell	58	F2	S2	40	6	T2	R2	520	On Request	65	2.5	Shrinkwrapped on pallets (wood)
A4027A	Coleridge Yellow Multi	Ashdown	47	F2	S2	30	15	T1	R1	500	12500	65	2.2	Banded (plastic)
NA2611A	Commercial Red	Birtley	63	F2	S2	20	12	Tm	Rm	192	9184	65	5.6	Shrinkwrapped on pallets
C2611A	Commercial Red 73mm	Birtley	23	F2	S2	20	12	Tm	Rm	328	9184	73	3.2	Banded (plastic) and shrinkwrapped
KGB-CONIFER	Conifer Glazed	Clerkenwell	67	F2	S2	125	4.5	T2	R2	364	8736	65	2.7	Shrinkwrapped on pallets (wood)
KGB-CONKER	Conker Glazed	Clerkenwell	68	F2	S2	125	4.5	T2	R2	364	8736	65	2.7	Shrinkwrapped on pallets (wood)
A5149A	Continental Buff	Clerkenwell	43	TBC	S2	40	6	T2	R2	468	TBC	2.4	2.4	Shrinkwrapped on pallets (wood)
A4527A	Cooksbridge Rustic Blend	Chailey	47	F2	S2	12.5	12	T1	R1	370	12210	65	2.2	Banded (plastic)
A4512A	Cooksbridge Yellow Clamp Stock	Chailey	47	F2	S2	12	12	T1	R1	370	12210	65	2.2	Banded (plastic)
KGB-COPPER	Copper Glazed	Clerkenwell	67	F2	S2	125	4.5	T2	R2	364	8736	65	2.7	Shrinkwrapped on pallets (wood)

*May be lower for a crane off-load vehicle

Brick Code	Product Name	Factory	Page	Durability	Active Soluble Salts	Compressive Strength N/mm ² (>)	Water Absorption % (<)	Size Tolerance mean	Size Tolerance Range	Pack Quantity	Maximum Load Size*	Brick Height mm	Dry Brick Weight Kg	Packaging
C														
A4001A	Cottage Mixture	Ashdown	32	F2	S2	30	15	T1	R1	500	13000	65	2.3	Banded (plastic)
KGB-CREAM	Cream Glazed	Clerkenwell	65	F2	S2	125	4.5	T2	R2	364	8736	65	2.7	Shrinkwrapped on pallets (wood)
A4002A	Crowborough Multicoloured Stock	Ashdown	59	F2	S2	30	15	T1	R1	500	1300	65	2.3	Banded (plastic)
A2629A	Cumberland Blend	Birtley	31	F2	S2	20	12	Tm	Rm	392	10976	65	2.7	Banded (plastic) and shrinkwrapped
D														
A5146A	Dark Grey	Clerkenwell	58	F2	S2	40	6	T2	R2	468	On Request	65	2.4	Banded (plastic)
KGB-DARKGREY	Dark Grey Glazed	Clerkenwell	67	F2	S2	125	4.5	T2	R2	364	8736	65	2.7	Shrinkwrapped on pallets (wood)
KGB-DARKSALMON	Dark Salmon Glazed	Clerkenwell	68	F2	S2	125	4.5	T2	R2	364	8736	65	2.7	Shrinkwrapped on pallets (wood)
A2803A	Dilston Blend	Throckley	48	F2~	S2	60	10	T2	R1	500	12000	65	2.3	Banded (plastic) and shrinkwrapped
A0102A	Dinian Blend	Leicester	47	F2	S2	15	25	T2	R1	430	14190	65	2	Banded (plastic) and shrinkwrap caps
A4102A	Dorking Multi	South Holmwood	37	F2	S2	40	12	T2	R1	500	14000	65	2.1	Banded (plastic)
A4125A	Dorking Red	South Holmwood	28	F2	S2	40	12	T2	R1	500	14000	65	2.1	Banded (plastic)
A4941A	Dorset Multi Red Stock	Ellistown	33	F2	S2	20	19	T2	R1	500	12500	65	2.2	Banded (plastic) and shrinkwrapped
A4932A	Dorset Red Stock	Ellistown	24	F2	S2	20	19	T2	R1	500	12500	65	2.2	Banded (plastic) and shrinkwrapped
E														
A5087A	Emral	Clerkenwell	52	F2	S2	40	6	T2	R2	520	On Request	65	2.5	Shrinkwrapped on pallets (wood)
A2905A	Etruria Mixture	Chesterton	37	F2~	S2	60	7	T2	R1	500	12500	65	2.3	Banded (plastic)
F														
A5171A	Finnieston	Clerkenwell	43	TBC	S2	40	6	T2	R2	520	TBC	1.8	1.8	Shrinkwrapped on pallets (wood)
A5091A	Finnieston Smooth	Clerkenwell	44	TBC	S2	40	6	T2	R2	520	TBC	1.8	1.8	Shrinkwrapped on pallets (wood)
A0104A	Floriana Blend	Leicester	48	F2	S2	15	25	T2	R1	430	14190	65	2	Banded (plastic) and shrinkwrap caps
A4053A	Funton Old Chelsea Yellow	Ashdown	46	F2	S2	12	21	Tm	Rm	500	11500	65	2.1	Plastic banded on pallets
G														
KGB-GARLAND	Garland Glazed	Clerkenwell	65	F2	S2	125	4.5	T2	R2	364	8736	65	2.7	Shrinkwrapped on pallets (wood)
A0803A	Gault Cream Stock	Eclipse	42	F2	S2	15	25	T2	R1	430	14000	65	2	Banded (plastic) and shrinkwrap caps
A5086A	Gowan	Clerkenwell	58	F2	S2	40	6	T2	R2	520	On Request	65	2.5	Shrinkwrapped on pallets (wood)
A2769A	Grainger Antique	Throckley	26	F2~	S2	60	10	T2	R1	500	12000	65	2.3	Banded (plastic) and shrinkwrapped
A2770A	Grainger Autumn	Throckley	29	F2~	S2	60	10	T2	R1	500	12000	65	2.3	Banded (plastic) and shrinkwrapped
A2771A	Grainger Gold	Throckley	49	F2~	S2	50	9	T2	R1	500	12000	65	2.3	Banded (plastic) and shrinkwrapped
A2965A	Grampian Red	Chesterton	27	F2~	S2	60	7	T2	R1	500	12500	65	2.3	Banded (plastic) and shrinkwrapped
A2967A	Grampian Red Mixture	Chesterton	37	F2~	S2	60	7	T2	R1	500	12500	65	2.3	Banded (plastic) and shrinkwrapped
A0176A	Grosvenor Autumn Flame	Leicester	34	F2	S2	20	19	T2	R1	430	12470	65	2.1	Banded (plastic) and shrinkwrap caps
A0149A	Grosvenor County Mixture	Leicester	35	F2	S2	20	19	T2	R1	430	12470	65	2.1	Banded (plastic) and shrinkwrap caps

*May be lower for a crane off-load vehicle

Brick Code	Product Name	Factory	Page	Durability	Active Soluble Salts	Compressive Strength N/mm ² (>)	Water Absorbtion % (<)	Size Tolerance mean	Size Tolerance Range	Pack Quantity	Maximum Load Size*	Brick Height mm	Dry Brick Weight Kg	Packaging
H														
A2708A	Hadrian Buff	Throckley	42	F2~	S2	50	9	T2	R1	500	12000	65	2.3	Banded (plastic) and shrinkwrapped
A2709A	Hadrian Red	Throckley	29	F2~	S2	60	10	T2	R1	500	12000	65	2.3	Banded (plastic) and shrinkwrapped
A4517A	Hamsey Mixed Stock	Chailey	34	F2	S2	12	12	T1	R1	370	12210	65	2.2	Banded (plastic)
A2922A	Hanchurch Mixture	Chesterton	36	F2~	S2	60	7	T2	R1	500	12500	65	2.3	Banded (plastic) and shrinkwrapped
A2428A	Hardwicke Minster Beckstone Mixture	Dorket Head	49	F2	S2	40	16	T2	R1	475	13775	65	2	Banded (plastic) and shrinkwrapped
A2419A	Hardwicke Minster Cream Blend	Dorket Head	43	F2	S2	40	16	T2	R1	475	13775	65	2.1	Banded (plastic) and shrinkwrapped
A2418A	Hardwicke Minster Sandstone Mixture	Dorket Head	49	F2	S2	40	16	T2	R1	475	13775	65	2	Banded (plastic) and shrinkwrapped
A2478A	Hardwicke Oakham Blend	Dorket Head	37	F2	S2	40	16	T2	R1	475	13775	65	2	Banded (plastic) and shrinkwrapped
A2417A	Hardwicke Sherwood Blaze	Dorket Head	40	F2	S2	40	16	T2	R1	475	13775	65	2	Banded (plastic) and shrinkwrapped
A2426A	Hardwicke Welbeck Autumn Antique	Dorket Head	37	F2	S2	40	16	T2	R1	475	13775	65	2	Banded (plastic) and shrinkwrapped
A2423A	Hardwicke Welbeck Red Mixture	Dorket Head	40	F2	S2	40	16	T2	R1	475	13775	65	2	Banded (plastic) and shrinkwrapped
NH5076A	Harris	Clerkenwell	63	F2	S2	70	5	T2	R1	440	On Request	38	On Request	On Request
A3516A	Hearted Red Rustic	Ravenhead	27	F2	S2	60	9	T2	R1	500	12500	65	2.3	Banded (plastic)
A4989A	Heritage County Blend	Ellistown	25	F2	S2	20	19	T2	R1	500	12500	65	2.2	Banded (plastic) and shrinkwrapped
A4977A	Heritage Light Red Multi	Ellistown	34	F2	S2	20	19	T2	R1	500	12500	65	2.2	Banded (plastic) and shrinkwrapped
A4986A	Heritage Red Blend	Ellistown	24	F2	S2	20	19	T2	R1	500	12500	65	2.2	Banded (plastic) and shrinkwrapped
A0358A	Himley Ash Grey	Aldridge	60	F2	S2	45	12	T2	R1	316	12240	65	2.1	Banded (plastic)
A0355A	Himley Dark Brown Rustic	Aldridge	56	F2	S2	40	12	T2	R1	316	12240	65	2.3	Banded (plastic)
A0354A	Himley Ebony Black	Aldridge	52	F2	S2	40	12	T2	R1	316	12240	65	2.3	Banded (plastic)
A4149A	Holbrook Sandfaced Black	South Holmwood	51	F2	S2	40	12	T2	R1	500	12500	65	2.1	Banded (plastic) and shrinkwrapped
A4119A	Holbrook Sandfaced Brown	South Holmwood	56	F2	S2	40	12	T2	R1	500	12500	65	2.1	Banded (plastic) and shrinkwrapped
A4120A	Holbrook Sandfaced Dark	South Holmwood	51	F2	S2	40	12	T2	R1	500	12500	65	2.1	Banded (plastic) and shrinkwrapped
A2916A	Hollington Blend	Chesterton	27	F2~	S2	60	7	T2	R1	500	12500	65	2.3	Banded (plastic)
A4157A	Holmwood Natural	South Holmwood	29	F2	S2	40	12	T2	R1	500	13500	65	2.1	Banded (plastic) and shrinkwrapped
I														
KGB-IODINE	Iodine Glazed	Clerkenwell	66	F2	S2	125	4.5	T2	R2	364	8736	65	2.7	Shrinkwrapped on pallets (wood)
A0060A	Ivanhoe Antique	Leicester	31	F2	S2	20	19	T2	R1	430	12470	65	2.1	Banded (plastic) and shrinkwrap caps
A0061A	Ivanhoe Athena Blend	Leicester	46	F2	S2	20	20	T2	R1	430	14190	65	2	Banded (plastic) and shrinkwrap caps
A0055A	Ivanhoe Cottage Blend	Leicester	32	F2	S2	20	19	T2	R1	430	12470	65	2.1	Banded (plastic) and shrinkwrap caps
A0054A	Ivanhoe Cream Original	Leicester	47	F2	S2	15	25	T2	R1	430	14190	65	2	Banded (plastic) and shrinkwrap caps
A0059A	Ivanhoe Katrina Multi	Leicester	31	F2	S2	20	19	T2	R1	430	12470	65	2.1	Banded (plastic) and shrinkwrap caps
A0058A	Ivanhoe Mellow Red	Leicester	33	F2	S2	20	19	T2	R1	430	12040	65	2.1	Banded (plastic) and shrinkwrap caps
A0062A	Ivanhoe Olde Village	Leicester	34	F2	S2	20	19	T2	R1	430	12470	65	2.1	Banded (plastic) and shrinkwrap caps
A0825A	Ivanhoe Westminster	Eclipse	34	F2	S2	20	19	T2	R1	500	13000	65	2.5	Banded (plastic) and shrinkwrapped

*May be lower for a crane off-load vehicle

Brick Code	Product Name	Factory	Page	Durability	Active Soluble Salts	Compressive Strength N/mm ² (>)	Water Absorption % (<)	Size Tolerance mean	Size Tolerance Range	Pack Quantity	Maximum Load Size*	Brick Height mm	Dry Brick Weight Kg	Packaging
J														
KGB-JADE	Jade Glazed	Clerkenwell	67	F2	S2	125	4.5	T2	R2	364	On Request	65	2.7	Shrinkwrapped on pallets (wood)
A5092A	Jericho Smooth	Clerkenwell	52	F2	S2	40	6	T2	R2	520	On Request	65	2.5	Shrinkwrapped on pallets (wood)
A5166A	Jericho Textured	Clerkenwell	52	F2	S2	40	6	T2	R2	468	On Request	65	2.5	Shrinkwrapped on pallets (wood)
K														
A5085A	Kensey	Clerkenwell	58	F2	S2	40	6	T2	R2	468	On Request	65	2.5	Shrinkwrapped on pallets (wood)
A2767A	Kilcreggan Multi Wirecut	Throckley	38	F2~	S2	60	10	T2	R1	500	12000	65	2.3	Banded (plastic) and shrinkwrapped
A4355A	Kingston Handmade Heather Red	Swanage	23	F2	S2	15	13	T1	R1	476	On Request	65	2.5	Shrinkwrapped on pallets (wood)
A4357A	Kingston Handmade Light Red	Swanage	23	F2	S2	15	13	T1	R1	476	On Request	65	2.5	Shrinkwrapped on pallets (wood)
R4357A	Kingston Handmade Light Red Imp.	Swanage	23	F2	S2	15	13	T1	R1	420	On Request	Bespoke size	2.9	Shrinkwrapped on pallets (wood)
A4356A	Kingston Handmade Light Red Multi	Swanage	31	F2	S2	15	13	T1	R1	476	On Request	65	2.9	Shrinkwrapped on pallets (wood)
R4356A	Kingston Handmade Light Red Multi Imp.	Swanage	31	F2	S2	15	13	T1	R1	420	On Request	Bespoke size	2.9	Shrinkwrapped on pallets (wood)
A4354A	Kingston Handmade Restoration Red	Swanage	23	F2	S2	15	13	T1	R1	476	On Request	65	2.9	Shrinkwrapped on pallets (wood)
L														
A3035A	Lambourn Orange Multi Stock	Parkhouse	34	F2	S2	15	13	T2	R1	500	10500	65	2.5	Banded (plastic)
K0773A	Laybrook Flame Red Stock Paver	Laybrook	70	Rigid (Mortar bedded)	FP100	T2	A1	U3	FP100	500	On Request	In accordance with BS EN 1344_2002	2.0	On Request
E0756A	Laybrook Imperial Red Stock	Laybrook	24	F2	S2	20	19	T1	R1	430	10320	68	2.7	Banded (plastic)
A0772A	Laybrook Multi Orange Stock	Laybrook	33	F2	S2	25	14	T2	R1	475	11400	65	2.3	Banded (plastic)
M0727A	Laybrook Red Multi Stock Paver	Laybrook	70	Flexible (Sand bedded)	FP100	T2	A1	U3	FP100	475	On Request	In accordance with BS EN 1344_2003	2.7	On Request
MN0773A	Laybrook SUDS Flame Red Stock Paver	Laybrook	70	Flexible (Grit bedded)	FP100	T2	A1	U3	FP100	500	On Request	In accordance with BS EN 1344_2004	2.4	On Request
MN0726A	Laybrook SUDS Multi Stock Paver	Laybrook	70	Flexible (Grit bedded)	FP100	T2	A1	U3	FP100	500	On Request	In accordance with BS EN 1344_2005	2.4	On Request
MN0727A	Laybrook SUDS Red Multi Stock Paver	Laybrook	70	Flexible (Grit bedded)	FP100	T2	A1	U3	FP100	500	On Request	In accordance with BS EN 1344_2006	2.4	On Request
A4937A	Leicester Autumn Multi	Ellistown	33	F2	S2	20	19	T2	R1	500	12500	65	2.2	Banded (plastic) and shrinkwrapped
A4978A	Leicester Grey Stock	Ellistown	59	F2	S2	20	22	T2	R1	500	13500	65	2.1	Banded (plastic) and shrinkwrapped
A0836A	Leicester Multi Cream Stock	Eclipse	47	F2	S2	15	25	T2	R1	430	13000	65	2	Banded (plastic) and shrinkwrap caps
A0812A	Leicester Multi Red Stock	Eclipse	34	F2	S2	20	19	T2	R1	500	13000	65	2.2	Banded (plastic) and stretchwrapped
A0841A	Leicester Multi Yellow Stock	Eclipse	42	F2	S2	25	20	T2	R1	430	13000	65	2	Banded (plastic) and shrinkwrap caps
A4946A	Leicester Orange Stock	Ellistown	25	F2	S2	20	19	T2	R1	500	12500	65	2.2	Banded (plastic) and shrinkwrapped
A0802A	Leicester Red Stock	Eclipse	24	F2	S2	20	19	T2	R1	500	13000	65	2.2	Banded (plastic) and shrinkwrapped
A4933A	Leicester Weathered Grey Stock	Ellistown	59	F2	S2	20	22	T2	R1	500	13500	65	2.1	Banded (plastic) and shrinkwrapped
A4935A	Leicester Weathered Multi	Ellistown	35	F2	S2	20	19	T2	R1	500	12500	65	2.2	Banded (plastic) and shrinkwrapped

*May be lower for a crane off-load vehicle

Brick Code	Product Name	Factory	Page	Durability	Active Soluble Salts	Compressive Strength N/mm ² (>)	Water Absorption % (<)	Size Tolerance mean	Size Tolerance Range	Pack Quantity	Maximum Load Size*	Brick Height mm	Dry Brick Weight Kg	Packaging
L														
A0834A	Leicester Weathered Multi	Eclipse	32	F2	S2	20	19	T2	R1	500	12500	65	2.2	Banded (plastic) and stretchwrapped
A0813A	Leicester Weathered Red Stock	Eclipse	32	F2	S2	20	19	T2	R1	500	13500	65	2.2	Banded (plastic) and stretchwrapped
NE5073A	Lewis	Clerkenwell	62	F2	S2	17.5	14	T2	R1	440	On Request	40	On Request	On Request
KGB-LEMON	Lemon Glazed	Clerkenwell	65	F2	S2	125	4.5	T2	R2	364	8736	65	2.7	Shrinkwrapped on pallets (wood)
A5147A	Light Grey	Clerkenwell	58	F2	S2	40	6	T2	R2	468	On Request	65	2	Banded (plastic)
KGB-LIGHTGREY	Light Grey Glazed	Clerkenwell	65	F2	S2	125	4.5	T2	R2	364	8736	65	2.7	Shrinkwrapped on pallets (wood)
KGB-LIME	Lime Glazed	Clerkenwell	65	F2	S2	125	4.5	T2	R2	364	8736	65	2.7	Shrinkwrapped on pallets (wood)
KGB-LONDONWHITE	London White Glazed	Clerkenwell	65	F2	S2	125	4.5	T2	R2	364	8736	65	2.7	Shrinkwrapped on pallets (wood)
NE5079A	Lundy	Clerkenwell	62	F2	S2	12.5	16	T2	R1	434	On Request	40	On Request	On Request
M														
A2933A	Manorial Mixture	Chesterton	37	F2~	S2	60	7	T2	R1	500	12500	65	2.3	Banded (plastic) and shrinkwrapped
A2902A	Manorial Red	Chesterton	26	F2~	S2	60	7	T2	R1	500	12500	65	2.3	Banded (plastic) and shrinkwrapped
A3016A	Marlborough Stock	Parkhouse	42	F2	S2	15	13	T2	R1	500	10500	65	2.5	Banded (plastic)
A3016A	Marlborough Stock	Parkhouse	42	TBC	S2	15	13	T2	R1	500	10500	2.4	2.4	Banded (plastic)
A3025A	Mellow Ashridge Stock	Parkhouse	25	F2	S2	15	13	T2	R1	500	10500	65	2.5	Banded (plastic)
A3010A	Mellow Regent Stock	Parkhouse	25	F2	S2	15	13	T2	R1	500	10500	65	2.5	Banded (plastic)
A2919A	Mercia Antique	Chesterton	37	F2~	S2	60	7	T2	R1	500	12500	65	2.3	Banded (plastic) and shrinkwrapped
A2974A	Mercia Orange	Chesterton	29	F2~	S2	60	7	T2	R1	500	12500	65	2.3	Banded (plastic) and shrinkwrapped
A2976A	Mercia Orange Multi	Chesterton	36	F2~	S2	60	7	T2	R1	500	12500	65	2.3	Banded (plastic) and shrinkwrapped
KGB-MIDBLUE	Mid Blue Glazed	Clerkenwell	66	F2	S2	125	4.5	T2	R2	364	8736	65	2.7	Shrinkwrapped on pallets (wood)
A2775A	Milburn Ashen Brown Blend	Throckley	56	F2~	S2	60	10	T2	R1	500	12000	65	2.3	Banded (plastic) and shrinkwrapped
A2630A	Millhouse Blend	Birtley	46	F2	S2	20	12	Tm	Rm	392	10976	65	2.7	Banded (plastic) and shrinkwrapped
KGB-MINT	Mint Glazed	Clerkenwell	67	F2	S2	125	4.5	T2	R2	364	8736	65	2.7	Shrinkwrapped on pallets (wood)
A2760A	Mixed Buff Rustic	Throckley	42	F2~	S2	40	9	T2	R1	500	12000	65	2.2	Banded (plastic) and shrinkwrapped
A2703A	Mixed Red Textured	Throckley	27	F2~	S2	60	10	T2	R1	500	12000	65	2.3	Banded (plastic) and shrinkwrapped
A5164A	Montpelier	Clerkenwell	58	F2	S2	40	6	T2	R2	468	On Request	65	2	Shrinkwrapped on pallets (wood)
A2804A	Morpeth Blend	Throckley	37	F2~	S2	60	10	T2	R1	500	12000	65	2.3	Banded (plastic) and shrinkwrapped
A5162A	Moseley	Clerkenwell	42	TBC	S2	40	6	T2	R2	468	TBC	2	2	Shrinkwrapped on pallets (wood)
A2934A	Multi Red Smooth	Chesterton	38	F2~	S2	60	7	T2	R1	500	12500	65	2.3	Banded (plastic) and shrinkwrapped
N														
NA2207A	Natural Blue Riven Textured Linear	Lodge Lane	62	F2	S2	30	9	T2	R1	256	On Request	65	4.7	Shrinkwrapped on pallets (wood)
NA2206A	Natural Blue Smooth Linear	Lodge Lane	62	F2	S2	30	9	T2	R1	256	On Request	65	4.7	Shrinkwrapped on pallets (wood)
KGB-NAVYBLUE	Navy Blue Glazed	Clerkenwell	66	F2	S2	125	4.5	T2	R2	364	8736	65	2.7	Shrinkwrapped on pallets (wood)
A0269A	New Burntwood Red Rustic	Aldridge	35	F2	S2	35	12	T2	R1	316	12240	65	2.2	Banded (plastic)
A3018A	New Cavendish Stock	Parkhouse	24	F2	S2	15	13	T2	R1	500	10500	65	2.5	Banded (plastic)

*May be lower for a crane off-load vehicle

Brick Code	Product Name	Factory	Page	Durability	Active Soluble Salts	Compressive Strength N/mm ² (>)	Water Absorption % (<)	Size Tolerance mean	Size Tolerance Range	Pack Quantity	Maximum Load Size*	Brick Height mm	Dry Brick Weight Kg	Packaging
N														
A4514A	New Chailey Rustic Stock	Chailey	35	F2	S2	12	12	T1	R1	370	12210	65	2.2	Banded (plastic)
A4501A	New Chailey Stock	Chailey	33	F2	S2	12.5	12	T1	R1	370	12210	65	2.2	Banded (plastic)
A5143A	New Diana	Clerkenwell	44	TBC	S2	40	6	T2	R2	520	TBC	1.8	1.8	Shrinkwrapped on pallets (wood)
A0805A	New Ivanhoe Cream	Eclipse	47	F2	S2	15	25	T2	R1	500	14000	65	2	Banded (plastic) and shrinkwrapped
A3057A	New Sandhurst Stock	Parkhouse	24	F2	S2	15	13	T2	R1	500	10500	65	2.5	Banded (plastic)
A0083A	Niveus	Leicester	47	F2	S2	15	25	T2	R1	430	14190	65	2	Banded (plastic and shrinkwrapped)
A2618A	Northern Buff	Birtley	46	F2	S2	20	12	Tm	Rm	392	10976	65	2.7	Banded (plastic) and shrinkwrapped
A2622A	Northumbrian Cottage	Birtley	23	F2	S2	20	12	Tm	Rm	404	10976	65	2.7	Banded (plastic) and shrinkwrapped
O														
A3527A	Oakleigh Red Blend	Ravenhead	36	F2	S2	60	9	T2	R1	500	12500	65	2.3	Banded (plastic)
A2715A	Oatmeal Textured	Throckley	42	F2~	S2	50	9	T2	R1	500	12000	65	2.3	Banded (plastic) and shrinkwrapped
A3532A	Oldcott Rustic	Ravenhead	29	F2	S2	50	12	T2	R1	500	12500	65	2.2	Banded (plastic)
NA2602A	Olde English	Birtley	63	F2	S2	20	12	Tm	Rm		10976			
NA2605A	Olde English Buff	Birtley	63	F2	S2	20	12	Tm	Rm		10976			
A2640A	Olde English Grey	Birtley	59	F2	S2	20	12	Tm	Rm	392	10976	65	2.6	Banded (plastic) and shrinkwrapped
NB2640A	Olde English Grey	Birtley	63	No data available							10976			
KGB-GREEN	Olive Green Glazed	Clerkenwell	67	F2	S2	125	4.5	T2	R2	364		65	2.7	Shrinkwrapped on pallets (wood)
A3518A	Ormonde Antique Blend	Ravenhead	37	F2	S2	50	12	T2	R1	500	12500	65	2.2	Banded (plastic)
A2621A	Otterburn Antique	Birtley	24	F2	S2	20	12	Tm	Rm	392	10976	65	2.7	Banded (plastic) and shrinkwrapped
P														
A0708A	Parham Red Stock	Laybrook	24	F2	S2	25	14	T2	R1	475	11400	65	2.3	Banded (plastic)
NA0708A	Parham Red Stock	Laybrook	62	F2	S2	12	19	T1	R1	On Request	11400	65	5.2	Shrinkwrapped on pallets
A5169A	Partick	Clerkenwell	58	F2	S2	40	6	T2	R2	468	On Request	65	2	Shrinkwrapped on pallets (wood)
A0700A	Petworth Multi Stock	Laybrook	34	F2	S2	25	14	T2	R1	475	11875	65	2.3	Banded (plastic)
KGB-PEWTER	Pewter Glazed	Clerkenwell	68	F2	S2	125	4.5	T2	R2	364	On Request	65	2.7	Shrinkwrapped on pallets (wood)
KGB-PLUM	Plum Glazed	Clerkenwell	68	F2	S2	125	4.5	T2	R2	364	On Request	65	2.7	Shrinkwrapped on pallets (wood)
C3594A	Pre War Common	Ravenhead	39	F2	S2	50	12	T2	R1	424	11024	73	2.6	Banded (plastic)
R														
A3613A	Ramian Red Stock Blend	Ravenhead	33	F2	S2	20	20	T2	R1	430	On Request	65	2	Banded (plastic and shrinkwrapped)
A3616A	Ramian Red Stock	Ravenhead	33	F2	S2	20	20	T2	R1	430	On Request	65	2	Banded (plastic and shrinkwrapped)
A3615A	Ramian Red Multi Stock	Ravenhead	33	F2	S2	20	20	T2	R1	430	On Request	65	2	Banded (plastic and shrinkwrapped)
A3614A	Ramian Buff Stock Blend	Ravenhead	47	F2	S2	20	20	T2	R1	430	On Request	65	2	Banded (plastic and shrinkwrapped)
A3612A	Ramian Buff Stock	Ravenhead	47	F2	S2	20	20	T2	R1	430	On Request	65	2	Banded (plastic and shrinkwrapped)
A3611A	Ramian Buff Multi Stock	Ravenhead	47	F2	S2	20	20	T2	R1	430	On Request	65	2	Banded (plastic and shrinkwrapped)
A3502A	Ravenhead Red Rustic	Ravenhead	28	F2	S2	60	9	T2	R1	500	12500	65	2.3	Banded (plastic)

*May be lower for a crane off-load vehicle

Brick Code	Product Name	Factory	Page	Durability	Active Soluble Salts	Compressive Strength N/mm ² (>)	Water Absorbtion % (<)	Size Tolerance mean	Size Tolerance Range	Pack Quantity	Maximum Load Size*	Brick Height mm	Dry Brick Weight Kg	Packaging
R														
A3501A	Ravenhead Red Smooth	Ravenhead	28	F2	S2	60	9	T2	R1	500	12500	65	2.2	Banded (plastic)
A4145A	Reigate Medium Multi	South Holmwood	37	F2	S2	40	12	T2	R1	500	14500	65	2.1	Banded (plastic) and shrinkwrapped
A4148A	Reigate Purple	South Holmwood	38	F2	S2	40	12	T2	R1	500	14000	65	2.1	Banded (plastic) and shrinkwrapped
A2213A	Riven Blue	Lodge Lane	54	F2	S2	75	7	T2	R1	380	On Request	65	2.4	Shrinkwrapped on pallets (wood)
A2214A	Riven Brindle	Lodge Lane	54	F2	S2	75	7	T2	R1	380	On Request	65	2.4	Shrinkwrapped on pallets (wood)
A5172A	Romsey	Clerkenwell	42	F2	S2	40	6	T2	R2	468	n/a	65	2.4kg	Shrinkwrapped on pallets (wood)
3579	Roughdales Red Multi Rustic	Ravenhead	40	F2~	S2	60	9	T2	R1	500	12500	65	2.2	Banded (plastic) and shrinkwrapped
KGB-ROYALBLUE	Royal Blue Glazed	Clerkenwell	66	F2	S2	125	4.5	T2	R2	364	8736	65	2.7	Shrinkwrapped on pallets (wood)
C0256A	Ruskin Red 73mm	Aldridge	35	F2	S2	40	12	T2	R1	292	9344	73	2.7	Banded (plastic)
A4947A	Rustique Blend	Ellistown	34	F2	S2	20	19	T2	R1	500	12500	65	2.2	Banded (plastic) and shrinkwrapped
S														
NE5078A	Samson	Clerkenwell	63	F2	S2	30	7	T2	R1	440	On Request	40	On Request	On Request
A2731A	Sandalwood	Throckley	42	F2~	S2	50	9	T2	R1	500	12000	65	2.3	Banded (plastic) and shrinkwrapped
NE5072A	Sanday	Clerkenwell	63	F2	S2	30	7	T2	R1	440	On Request	40	On Request	On Request
A2406A	Sandringham	Dorset Head	43	F2	S2	40	16	T2	R1	475	13775	65	2	Banded (plastic) and shrinkwrapped
KGB-SATINGREY	Satin Grey Glazed	Clerkenwell	68	F2	S2	125	4.5	T2	R2	364	8736	65	2.7	Shrinkwrapped on pallets (wood)
KGB-SATINSKYBLUE	Satin Sky Blue Glazed	Clerkenwell	66	F2	S2	125	4.5	T2	R2	364	8736	65	2.7	Shrinkwrapped on pallets (wood)
A0730A	Sevenoaks Yellow Stock	Laybrook	46	F2	S2	25	19	Tm	Rm	475	12825	65	2	Banded (plastic) and shrinkwrapped
KGB-SKYBLUE	Sky Blue Glazed	Clerkenwell	66	F2	S2	125	4.5	T2	R2	364	8736	65	2.7	Shrinkwrapped on pallets (wood)
A2712A	Smooth Buff	Throckley	43	F2~	S2	50	9	T2	R1	500	12000	65	2.2	Banded (plastic) and shrinkwrapped
3536	Smooth Village Mixture	Ravenhead	29	F2	S2	50	12	T2	R1	500	12500	65	2.3	Banded (plastic) and shrinkwrapped
A2221A	Staffordshire Blue Brindle Dragface	Lodge Lane	54	F2~	S2	75	7	T2	R1	380	11400	65	2.4	Banded (plastic)
A2220A	Staffordshire Blue Brindle Smooth	Lodge Lane	54	F2~	S2	75	7	T2	R1	380	11400	65	2.4	Banded (plastic)
A0289A	Staffordshire Multi Rustic	Aldridge	36	F2	S2	35	12	T2	R1	316	12240	65	2.2	Banded (plastic)
A2232A	Staffordshire Slate Blue Smooth	Lodge Lane	54	F2~	S2	75	7	T2	R1	380	11400	65	2.4	Banded (plastic)
NE5077A	Stronsay	Clerkenwell	63	F2	S2	30	5	T2	R1	440	n/a	40	n/a	n/a
A2738A	Stuart Buff	Throckley	43	F2~	S2	50	9	T2	R1	500	12000	65	2.2	Banded (plastic) and shrinkwrapped
A4132A	Surrey County Red	South Holmwood	28	F2	S2	40	12	T2	R1	500	13500	65	2.1	Banded (plastic)
A4152A	Surrey Damson Multi	South Holmwood	35	F2	S2	40	12	T2	R1	500	13500	65	2.1	Banded (plastic)
A4143A	Surrey Light Multi	South Holmwood	37	F2	S2	40	12	T2	R1	500	14500	65	2.1	Banded (plastic)
A4131A	Surrey Orange	South Holmwood	29	F2	S2	40	12	T2	R1	500	13500	65	2.1	Banded (plastic)
A4133A	Surrey Red Multi	South Holmwood	38	F2	S2	40	12	T2	R1	500	14000	65	2.1	Banded (plastic)
A4136A	Surrey Russet	South Holmwood	36	F2	S2	40	12	T2	R1	500	14500	65	2.1	Banded (plastic)
A4301A	Swanage Handmade Heather Red	Swanage	23	F2	S2	15	13	T1	R1	476	On Request	65	2.5	Shrinkwrapped on pallets (wood)
A4302A	Swanage Handmade Light Red	Swanage	23	F2	S2	15	13	T1	R1	476	On Request	65	2.5	Shrinkwrapped on pallets (wood)

*May be lower for a crane off-load vehicle

Brick Code	Product Name	Factory	Page	Durability	Active Soluble Salts	Compressive Strength N/mm ² (>)	Water Absorbtion % (<)	Size Tolerance mean	Size Tolerance Range	Pack Quantity	Maximum Load Size*	Brick Height mm	Dry Brick Weight Kg	Packaging
S														
A4303A	Swanage Handmade Light Red Multi	Swanage	31	F2	S2	15	13	T1	R1	476	On Request	65	2.5	Shrinkwrapped on pallets (wood)
A4312A	Swanage Handmade Restoration Red	Swanage	23	F2	S2	15	13	T1	R1	476	On Request	65	2.5	Shrinkwrapped on pallets (wood)
E4317A	Swanage Imperial Light Stock 68mm	Swanage	24	F2	S2	15	13	T1	R1	420	On Request	68	2.9	Shrinkwrapped on pallets (wood)
E4316A	Swanage Imperial Red Stock 68mm	Swanage	24	F2	S2	15	13	T1	R1	420	On Request	68	2.9	Shrinkwrapped on pallets (wood)
T														
A2790A	Tay Buff Multi	Throckley	48	F2~	S2	60	10	T2	R1	500	12000	65	2.2	Banded (plastic) and shrinkwrapped
A0079A	Tenebris	Leicester	59	F2	S2	20	20	T2	R1	430	14190	65	2	Banded (plastic and shrinkwrapped)
A0709A	Thakeham Red Multi Stock	Laybrook	32	F2	S2	25	14	T2	R1	475	11400	65	2.3	Banded (plastic)
A2724A	Throckley Old English	Throckley	27	F2~	S2	60	10	T2	R1	500	12000	65	2.3	Banded (plastic) and shrinkwrapped
KGB-TOFFEE	Toffee Glazed	Clerkenwell	68	F2	S2	125	4.5	T2	R2	364	8736	65	2.7	Shrinkwrapped on pallets (wood)
A2623A	Townhouse Blend	Birtley	31	F2	S2	20	12	Tm	Rm	392	10976	65	2.7	Banded (plastic) and shrinkwrapped
NA2623A	Townhouse Blend	Birtley	62	No data available							10976			
A0314A	Tradesman Antique Grey	Chesterton	60	F2~	S2	60	9	T2	R1	400	On Request	65	2.3	Banded (plastic)
A0619A	Tradesman Buff Multi	Cattybrook	48	F2	S2	50	12	T2	R1	500	12000	65	2.2	Banded (plastic)
A3598A	Tradesman Common	Ravenhead	39	F2	S2	50	12	T2	R1	500	12500	65	2.4	Banded (plastic)
A2949A	Tradesman Heather Mixture	Chesterton	36	F2~	S2	60	9	T2	R1	400	11600	65	2.3	Banded (plastic)
A2693A	Tradesman Light	Chesterton	60	F2~	S2	60	9	T2	R1	400	11500	65	2.3	Banded (plastic)
A3542A	Tradesman Light Rustic Blend	Ravenhead	39	F2	S2	50	12	T2	R1	500	12500	65	2.2	Banded (plastic)
A0620A	Tradesman Millgate Buff	Cattybrook	49	F2	S2	50	12	T2	R1	500	12000	65	2.2	Banded (plastic)
A0618A	Tradesman Rustic Blend	Cattybrook	26	F2~	S2	60	9	T2	R1	400	12000	65	2.2	Banded (plastic)
A0605A	Tradesman Tudor Regent	Cattybrook	26	F2~	S2	60	9	T2	R1	400	11500	65	2.2	Banded (plastic)
A3576A	Trafford Multi Rustic	Ravenhead	40	F2	S2	50	12	T2	R1	500	12500	65	2.2	Banded (plastic)
NE5081A	Tresco	Clerkenwell	63	F2	S2	30	5	T2	R1	440	On Request	40	On Request	On Request
W														
A2613A	Warwickshire Olde English	Birtley	24	F2	S2	20	12	Tm	Rm	392	10976	65	2.6	Banded (plastic) and shrinkwrapped
A0662A	Westbrick Red Purple Multi	Cattybrook	36	F2	S2	50	10	T2	R1	500	11500	65	2.4	Banded (plastic)
A3055A	Weston Red Multi Stock	Parkhouse	33	F2	S2	15	13	T2	R1	500	10500	65	2.5	Banded (plastic)
A5145A	White Engobe	Clerkenwell	44	TBC	S2	40	6	T2	R2	520	TBC	1.6	1.6	Banded (plastic)
KGB-WHITE	White Glazed	Clerkenwell	65	F2	S2	125	4.5	T2	R2	364	8736	65	2.7	Shrinkwrapped on pallets (wood)
A2407A	Windsor	Dorset Head	40	F2	S2	40	16	T2	R1	475	13775	65	2	Banded (plastic) and shrinkwrapped
A5084A	Winster	Clerkenwell	44	TBC	S2	40	6	T2	R2	520	TBC	2.5	2.5	Shrinkwrapped on pallets (wood)
A3509A	Worsley Weathered	Ravenhead	40	F2	S2	50	12	T2	R1	500	12500	65	2.2	Banded (plastic)
A2800A	Wylam Olde Blend	Throckley	39	F2~	S2	60	10	T2	R1	500	12000	65	2.3	Banded (plastic) and shrinkwrapped
Y														
KGB-YELLOW	Yellow Glazed	Clerkenwell	65	F2	S2	125	4.5	T2	R2	364	8736	65	2.7	Shrinkwrapped on pallets (wood)

*May be lower for a crane off-load vehicle



Ibstock Brick

Leicester Road, Ibstock,
Leicestershire LE67 6HS

t: 01530 261999

e: enquiries@ibstock.co.uk

www.ibstockplc.co.uk

Contact Numbers

Technical & Design Advice Helpline:
0844 800 4576

Order samples

www.ibstockbrick.co.uk/samples

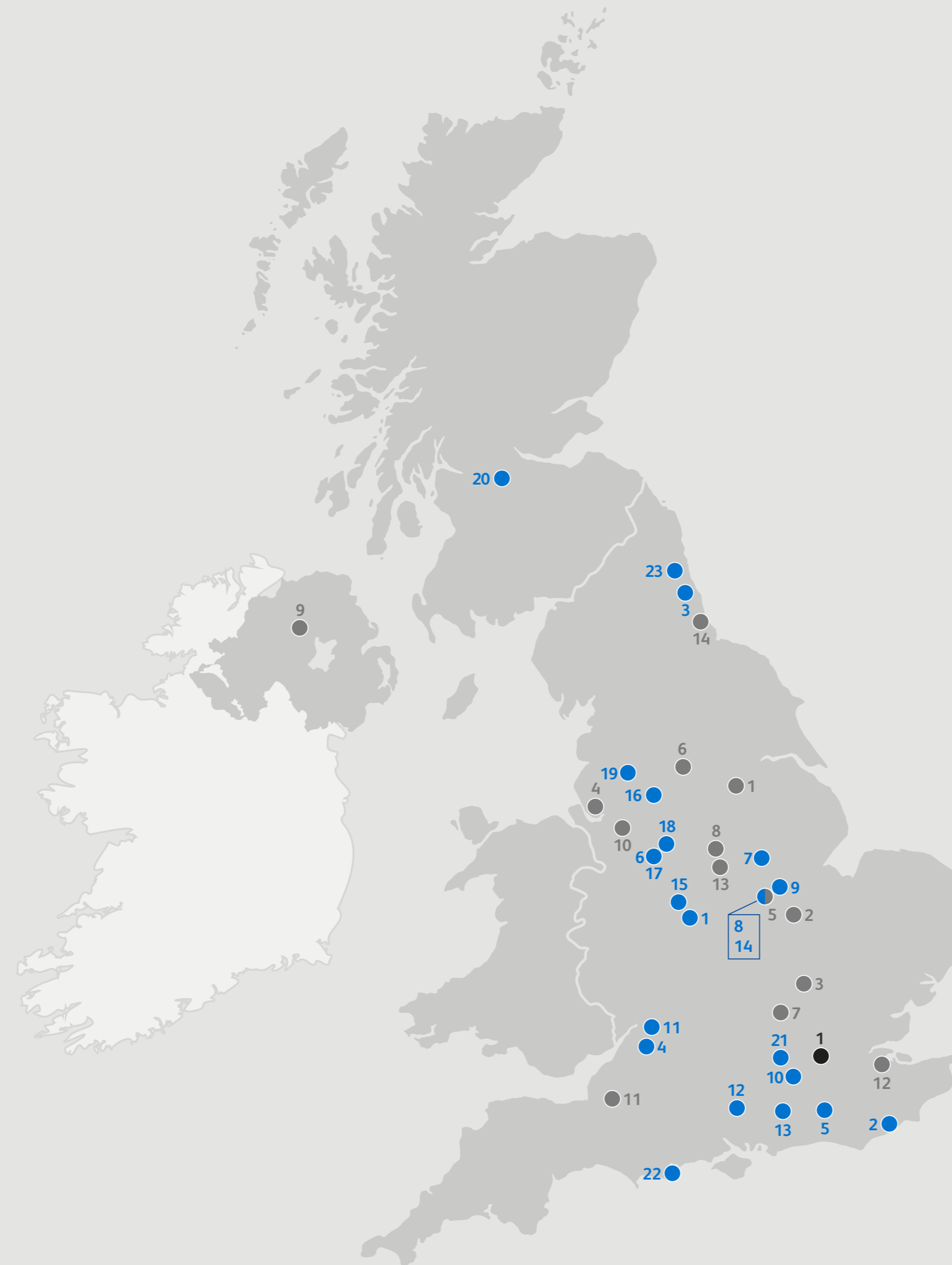

● I-Studio

1. Clerkenwell, London

● Ibstock Clay



- | | |
|------------------------|--|
| 1. Aldridge Factory | 14. Leicester Factory |
| 2. Ashdown Factory | 15. Lodge Lane Factory |
| 3. Birtley Factory | 16. Manchester Factory |
| 4. Cattybrook Factory | 17. Midlands Factory |
| 5. Chailey Factory | 18. Parkhouse Factory |
| 6. Chesterton Factory | 19. Ravenhead Factory |
| 7. Dorket Head Factory | 20. Scottish Sales Office
and Distribution Centre |
| 8. Eclipse Factory | 21. South Holmwood Factory |
| 9. Ellistown Factory | 22. Swanage Factory |
| 10. Gatwick Factory | 23. Throckley Factory |
| 11. Gloucester Factory | |
| 12. Hampshire Factory | |
| 13. Laybrook Factory | |

● Ibstock Concrete



- | | |
|---|-----------------------------|
| 1. Anstone Factory and
Ibstock Concrete
Customer Service Office | 7. Leighton Buzzard Factory |
| 2. Barnwell Factory | 8. Masoncrete Factory |
| 3. Bedford Factory | 9. Northern Ireland Factory |
| 4. Bootle Factory | 10. Northwich Factory |
| 5. Cebastone Factory | 11. Shearstone Factory |
| 6. Dewsbury Head Office
and Factory | 12. Sittingbourne Factory |
| | 13. Stretton Factory |
| | 14. Thornley Factory |

HEAD OFFICE

Ibstock plc, Leicester Road, Ibstock, Leicestershire LE67 6HS

T:01530 261999

F:01530 257457

E:enquiries@ibstock.co.uk

www.ibstockplc.co.uk



IBSTOCK BRICK'S COMMITMENT TO QUALITY

Ibstock Registered Firms – The first Quality Assurance Scheme in the industry, operating in accordance with BS EN ISO 9001 to be awarded Registered Firm Status for the design and the manufacture of bricks, pavers and special shapes.

IBSTOCK BRICK'S COMMITMENT TO THE ENVIRONMENT

In being the first UK brick manufacturer to achieve ISO 14001, the internationally recognised standard for all production sites and fully embracing the Government's strategy for sustainability, Ibstock Brick leads the way in demonstrating environmental responsibility. Ibstock Brick's commitment to responsible sourcing is demonstrated through their accreditation to BES 6001.

ABOUT THIS PUBLICATION

Although the instructions contained in this publication and any other information published by Ibstock are believed to be accurate at the date of publication, they are strictly for guidance only and (the Company) accepts no liability in relation to their use or for any losses, howsoever caused. You are responsible for taking all reasonable steps to ensure your use of the goods/products conforms to all applicable health and safety requirements from time to time. If in doubt, please consult appropriately qualified persons. All products sold by Ibstock Brick are sold subject to Ibstock Brick's Terms and Conditions of Sale, a copy of which is available on request.

The product photographs represent as accurately as possible, within the limitations of photography and printing, the colour of a representative sample of this range of products. However, Ibstock does not warrant that all bricks produced in this range will match exactly the colours reproduced in this brochure. View CE marking information at www.ibstock-ca.co.uk

© Ibstock Brick 2023