



Product Price Guide

PGAP24 | JUNE 2024

- Roof Ventilation
- Roof Drainage
- Roofing & Glazing Sheets
- Rooflights
- Cut to Size Service
- Hygienic Cladding





Ariel Plastics is *the* national plastics distribution company, offering the widest choice of roofing sheet, rooflights and roofing accessories available in the UK.



CUT TO SIZE SERVICE



The UK market leader for over 55 years, our product portfolio has grown extensively and now includes Roofing Sheet options in Polycarbonate, PVC, GRP and Bitumen sheet with a complete range of accessories.

Flat Glazing and Dome Rooflights, Roof Drainage, Roof Ventilation and Cladding

for commercial and residential construction projects.

Ariel's nationwide logistics operation, national sales team and dedicated customer support ensures that merchants throughout the UK receive the highest quality service, product and technical support.



Leave the cutting to the experts

- Cut to Size Service for
 - Polycarbonate
 - Acrylic
 - Styrene
- 48-hour service*
- **See Page 70**

*Terms & conditions apply



This price list supersedes all previous issues. All goods sold are subject to our standard Terms and Conditions of Sale (available on request from the Sales Office). Ariel Plastics Ltd reserves the right to amend specifications without prior notice.

Carrier Deliveries

Customers requiring a chargeable Next Day carrier service must submit their orders before 12:00 noon. Please note that carriers will not take goods longer than 4m and wider than 1m. Although we expect the carrier to deliver on a next day service, carriers are increasingly unable to guarantee this on all occasions. Basic carrier cost is £30.00, please contact sales office for full details.

Terms & Conditions

Please provide full delivery address with postcode, contact name and phone numbers and details of any site restrictions which may affect delivery. For details of the delivery schedule and delivery zones go to pages 94-95.

Ordering

When ordering please clearly state Product Code, Description and Quantity. 48 hour Hi-Lights Service orders must be placed by 12.30pm. All other orders must be received by 4pm (Mon-Thur), 3:30pm (Fri).

Prices

Irrespective of any prices stated on your orders, the prices charged by Ariel Plastics will be list prices less your agreed customer discount. List Prices exclude VAT.

Non Price List Products

Any goods not stated on the price list will be subject to extended lead times and a minimum order value of £250.00 net. These products are all non-returnable.

Cut to Size

Cut to size is a bespoke product and therefore non-returnable.

Cutting Charge

We reserve the right to apply a cutting charge for complicated or large cutting requests. Please contact the customer services department for details.

Quotations

Quotations will normally be processed within 24 hours. Earlier processing may be available on request. Complicated and structural quotations can take up to 48 hours to be fully processed.

Cancelled Orders

We reserve the right to charge up to £30.00 for any orders cancelled after the order cut off time to cover administration and/or delivery costs. Cancelled orders must be notified in writing before cut off time. Cut off time is 4.00pm.

Minimum Order Charges

Orders under £250.00 net will be subject to a £30.00 delivery charge.

Site Deliveries

Site deliveries are subject to a minimum order value of £250.00 and a one off charge of £30.00 (mainland GB only).

48hr Hi-Lights Service

Orders must be received by Ariel Plastics by 12.30pm. 48hr delivery is only available to mainland GB (excluding postcode areas beginning KW, IV, AB and PH). All Mardome returns must be in a re-saleable condition and rooflights will be subject to a 50% restocking charge plus £85 collection charge. All rooflights are subject to a £30 delivery charge. Please note that a £85 failed delivery charge applies to all rooflights.

Fixing Guides

Available to download from www.arielplastics.com

Collection

Goods may only be collected by prior arrangement.

Notification of Claims

The seller shall be entitled to reject any claim for DEFECTIVE goods unless such a claim is notified in writing to the Seller within 48 hours of delivery, or, if the alleged defect is not immediately apparent, within such longer period as the seller may reasonably allow in the circumstances. Mardomes are bespoke items and will incur a 50% restocking charge plus £85 collection charge if cancelled or returned. Returns must be in a re-saleable condition.

Vents are made to order and therefore non returnable.

The Seller shall be entitled to reject any claim for SHORTAGES of the goods unless such claim is notified to the Seller in writing within 48 hours of the date of delivery of any consignment in which it is said a shortage has occurred. Upon collection of goods, the Seller shall be entitled to credit goods only which are deemed resaleable.

The Seller will notify the Buyer within 48 hours of any rejections or discrepancies. It is recommended that orders are checked for completeness and defective parts before installation work commences. Failure to do so may affect the claim.

Contents

ROOF VENTILATION & DRAINAGE	Roof Ventilation	6
	Universal Ridge System	10
	Universal Hip System	11
	Roof Drainage	12
ROOFLINE	Dry Verge System	16
	Fascia & Soffit	18
ROOFING & GLAZING SHEET	Multiwall Polycarbonate Sheet	22
	Self Supporting Roofing System	36
	Easy Fit DIY Roofing System	38
	Modular Panel Glazing System	40
	Corrugated Polycarbonate	42
	PVC Sheet	48
	Corrugated Bitumen	52
	Bituminous Tile Strip	56
	Metal Roofing System	58
	Galvanised Corrugated Sheet	59
Flat Glazing	60	
ROOFLIGHTS	Polycarbonate Dome Rooflights	64
CUT TO SIZE SERVICE	Acrylic Sheet	71
	Multiwall Polycarbonate Sheet	72
	Flat Polycarbonate Sheet	76
CLADDING	Hygienic Cladding	78
	General Cladding	80
	Delivery Schedules	82



Roof Ventilation



SLATE, TILE AND RIDGE VENTILATION

An extensive range of **Corovent** Slate, Tile and Ridge ventilation products has been specially designed to eliminate the risk of condensation.

A comprehensive range of tile vents are available to match most roof tiles, with specials available on short lead times. Our tile matching service ensures that Corovent will always blend in discreetly with existing tiles, even on a weathered roof.

*Not suitable for roofs less than 20° pitch



EAVES VENTILATION

The wide range of eaves ventilation products and accessories can eliminate condensation by providing adequate airflow in the roof void, and avoids damage to the eaves and roof-felt finishing.

- Maintenance free
- Corrosion and rot resistant
- Strong and flexible

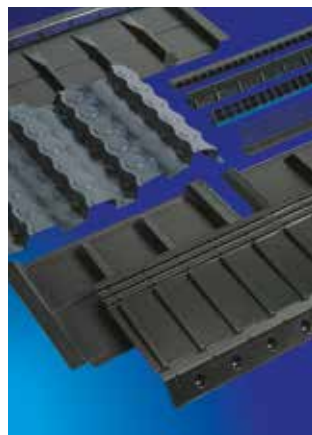

Our tile matching service ensures the Corovent will blend in with existing roof tiles.









Roof Vents PG72/76/77

Code	PG	Disc	Cowl Vents	Qty	Price £
CV10K	072	780	Cowl Vent - ventilation area 10,000mm ² including felt sleeve	1	63.38
CV20K	072	780	Cowl Vent - ventilation area 20,000mm ² including felt sleeve	1	67.31
CP10K	072	780	As CV10K but including a 110mm Pipe Adaptor	1	71.39
CP20K	072	780	As CV20K but including a 110mm Pipe Adaptor	1	94.25
CT1C	076	780	110mm dia flexi-tube including clips	1	41.34
CT1E	076	780	110mm PVC Coated flexi-tube including clips (1m length)	1	12.18
FW1	076	780	Felt weir	1	3.32
Code	PG	Disc	Roofline Vents (when ordering state whether slate or tile version)	Qty	Price £
DV10K	072	780	Discrete Roof Vent 10,000mm ²	1	131.86
DP10K	072	780	Discrete Roof Vent & pipe adaptor	1	151.19
RV10K	072	780	Roofline vent for slate or interlocking tiles 10,000mm ² vent area (includes felt weir)	1	131.86
RP10K	072	780	As RV10K but fitted with a 110mm dia pipe adaptor	1	151.19
COA1	072	780	110mm dia. outlet can be cut to provide 125mm dia sections	1	24.18
RV8K	072	780	Roofline vents for plain tiles 8000mm ² ventilation area	1	59.54
RP8K	072	780	As RV8K but including a 110mm dia pipe adaptor	1	70.37
NSA110	072	780	110mm dia adaptor to site convert RV8K to RP8K	1	16.14
UNI/SLATE	077	780	Slate Universal Vent 8000mm ² ventilation area	1	54.43
Code	PG	Disc	Economy Vents	Qty	Price £
HV1	076	780	7200mm ² vent area: 600x300mm slates	10	31.09
HV2	076	780	7200mm ² vent area: 500x250mm slates	10	25.69
HP1*	077	780	Vent terminal for 600x300mm slates	1	59.49
Code	PG	Disc	Ridgeline Vents	Qty	Price £
TV3N	072	780	Ridge vent 12,500mm ² vent area, suits most concrete & clay ridges	1	131.86
TV31N	072	780	As TV3N with fitted extension sleeve	1	146.00
TV3SN-110	072	780	As TV3N with fitted extension sleeve incl. 110mm dia pipe adaptor	1	153.22
TV3SN-125	072	780	As TV3N with fitted extension sleeve incl. 125mm dia pipe adaptor	1	153.22
NES	072	780	Narrow extension sleeve for short ridge vent less than 400mm long	1	14.16
WES	072	780	Wide extension sleeve for standard ridge vent more than 400mm long	1	14.16
WSA110	072	780	110mm dia adaptor for wide extension sleeve	1	14.16
WSA125	072	780	125mm dia adaptor for wide extension sleeve for passive vent system	1	14.16





When ordering tile vents please state manufacturer, tile and colour for matching purposes. *Includes soil pipe adaptor & flexi-tube.



Eaves Ventilation

	Code	PG	Disc	Product Description	Qty	Price £
	CF1	077	780	1m Eaves Comb Filler	300	0.96
	FT60	077	780	Eaves Fascia Tray 600mm long	50	2.44
	FT150	077	780	Eaves Fascia Tray 1500mm long	10	6.58
	RT50	077	780	6M Roll 300mm Wide Rafter Tray	20	10.32
	RT66	077	780	Rafter Tray Continuous 6m long roll 400mm wide, provides 25mm per LM air gap to fit common rafter spacings 600, 450, 400mm	4	13.77
	RT99	077	780	6M Roll 600mm Wide Rafter Tray	10	20.63
	RT132	077	780	6m Rafter Tray as above but 800mm wide, for low pitched roofs	4	27.50
	RT198	077	780	6M Roll 1200mm Wide Rafter Tray	4	43.73

Eaves & Fascia Ventilation

	Code	PG	Disc	Eaves Ventilation	Qty	Price £
	RT60	077	780	600mm Single Rafter Tray - provides 10mm per LM air gap	50	1.57
	RR46	077	780	Refurbishment Rafter Tray (48cm Long x 35cm Wide)	50	2.95
	Code	PG	Disc	Overfascia Vents	Qty	Price £
	OV10	077	780	Low profile - 1m x 10mm air gap	50	2.32
	FV10	077	780	Heavy duty - 1m x 10mm air gap	50	5.25
	FV25	077	780	Heavy duty - 1m x 25mm air gap	50	6.07

Soffit Vent

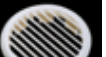
	Code	PG	Disc	Soffit Vents	Qty	Price £
	SD20W	077	780	Disc vent 2000mm ² ventilation area - white (80mm dia.)	50	0.73

Check out our website



Check out our website where you will find a selection of resources including product guides, certification, datasheets, installation guides and videos.

If you can't find what you're looking for or require additional guidance
Email info@arielplastics.com
 or **Call** 01246 281111.



arielplastics.com

Corovent URS

Universal Ridge System



Dry Fix System

View Installation Guide



The Corovent dry fix system is supplied as a complete system with all components to fix 6m of ridge.



Corovent Universal Ridge is designed to provide a totally dry fixed and weathertight ridge that is fast and simple to install. Every ridge unit is mechanically fixed eliminating the need for mortar completely.

- Unique jointing system for versatility
- Accommodates most known ridge tiles
- Can be used with both half round & angled ridges
- Dry fix is the fastest way to install ridge tiles
- No wet trades needed
- Smooth line providing a discreet appearance

Universal Dry Fix Ridge System (vented)

Code	PG	Disc	Product Description	Outer Qty	Price £
URS6/B	071	780	1 Dry Fix Roll Out 6m x 300mm 13 Dry Ridge Unions, Fixing Caps & Screws 10 Dry Ridge Union Brackets	1	102.21
URS6/RT	071	780	Dry Fix Roll Out 6m x 300mm	1	52.69
URS6/USB	071	780	Dry Ridge Unions, Fixing Caps & Screws	13	7.60

Designed for standard ridge tiles at 450mm width.

Corovent DHS

Dry Hip System



Dry Fix System

Corovent DHS provides a mechanically fixed, weathertight and attractive finish to the hip line without the use of mortar bedding. The Corovent DHS is fully compatible with Corovent URS Dry Ridge System.

- Quick & easy to install
- No special tools required
- Mortar free
- UV stable
- Water resistant

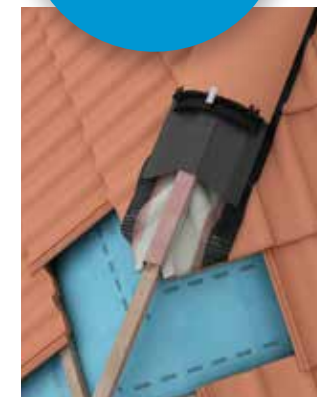

Dry Fix Hip System

Code	PG	Disc	Product Description	Outer Qty	Price £
URS6/B	071	780	1 Dry Fix Roll Out 6m x 300mm 13 Dry Ridge Unions, Fixing Caps & Screws 10 Dry Ridge Union Brackets	1	102.21
UHS6/FIX	071	780	4 75mm x 4.8 S/S Screws 4 Sealing Washers 50 25mm x 3.5 mm S/S ARS Nails	1	21.75
UHS6/TT	071	780	Tile Ties	30	1.23
UHS6/HST	071	780	PVC Hip Tray (1m Length)	1	11.91

Alternative to PVC Tray

Code	PG	Disc	Product Description	Outer Qty	Price £
HST3	071	780	GRP Hips Support Tray (3m Length)	1	27.55

The above items can also be sold separately. A PVC or a GRP Tray can be used.

Corodrain

Roof Drainage

The **Corodrain** range of BBA approved valley troughs are manufactured in GRP as an economic and durable alternative to using lead and all conform to NFRC Technical Bulletin 28.

Corodrain valley troughs can be used on both slate and tiled roofs and with any combination of double or interlocking slates, clay or concrete tiles. Corodrain can also provide a weatherproof seal between roofs of terraced houses or where a new roof needs to join an existing roof.

- A cost effective alternative to lead
- More resistant to damage and theft
- Maintenance free
- UV light and acid rain resistant
- Smooth finish inhibits growth of moss or build up of debris
- Significant reduction in installation time
- ISO 9001 & BBA Approved
- Largest range of lengths available

D-Valleys	A-Valleys	B-Valleys	Unequal Pitches	Dry Valleys
Standard Corodrain valley troughs for use with single and double lap tiles. Both standard (type:HD) and heavy duty (type:DX). They incorporate sanded strips (min. width 35mm) for the mortar to bond to.	Narrow Corodrain valley troughs for use with single and double lap tiles in limited applications. Both standard (type:HA) and heavy duty (type:AX). They incorporate sanded strips (min. width 35mm) for the mortar to bond to.	Standard Corodrain valley troughs for use with double lap slates and tiles, which are dry bedded. Both standard (type:HB) and heavy duty.	B & D-Valleys are designed for use where the differential between two rafter pitches is 15° or less. Industry standards recommend A-Valleys should only be used for pitch differences of 10° or less.	Dry fix valley trough completely eliminates risk of water coming into contact with the batten. No wet trades are required so it can be fitted in any weather.



Corodrain Standard Range

	Code	PG	Disc	Valley Trough	Outer Qty	Price £
A Type	Standard Weight - 360mm width (1.83kg/m²)					
	HA30	078	790	A type 3m long universal	10	34.16
	HB30	078	790	B type 3m long slate	10	34.16
B Type	HE30	078	790	E type 3m std valley trough (1.66kg/m²)	10	30.74
	Standard Weight - 410mm width (1.83kg/m²)					
E Type	HD30	078	790	D type 3m long universal	10	39.62
D Type	Heavy Weight - 360mm width (2.44kg/m²)					
	AX30	078	790	A type 3m universal heavy weight	10	61.49
BD30	Heavy Weight - 410mm width (2.44kg/m²)					
	DX30	078	790	D type 3m universal heavy weight	10	68.95
DD30	Diamond 60 - (2.44kg/m²)					
	BD30	078	790	B type 3m diamond 60 slate	10	76.48
	DD30	078	790	D type 3m diamond 60 universal	10	80.62

	Code	PG	Disc	Joining Gutter	Outer Qty	Price £
	HC30	078	790	3m long joining gutter	10	34.16

	Code	PG	Disc	Abutment Soaker	Outer Qty	Price £
	AS30	078	790	3m long abutment soaker	10	62.54
	AS30L	078	790	3m long abutment soaker lipped	10	68.18

	Code	PG	Disc	Slate Starter Strip	Outer Qty	Price £
	US30	077	790	3m long universal slate starter strip	10	60.67

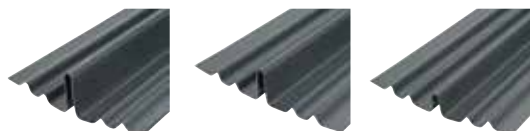

105mm upstand 80mm upstand 55mm upstand

Traditional Dry Fix Valley

Code	PG	Disc	Product Description	Width mm	Length mm	Price £
DVU30DW105	071	790	Traditional Dry Fix Valley - 105mm Upstand	370	3000	72.59
DVU30DW80	071	790	Traditional Dry Fix Valley - 80mm Upstand	370	3000	72.59
DVU30DW55	071	790	Traditional Dry Fix Valley - 55mm Upstand	370	3000	72.59

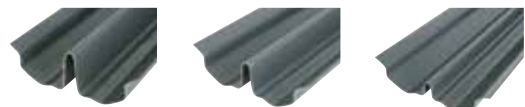

110mm upstand 90mm upstand 70mm upstand

Universal Dry Fix Valley

Code	PG	Disc	Product Description	Width mm	Length mm	Price £
DVU30SW110	071	790	Dry Fix Valley Standard - 110mm Upstand	280	3000	61.55
DVU30SW90	071	790	Dry Fix Valley Standard - 90mm Upstand	280	3000	61.55
DVU30SW70	071	790	Dry Fix Valley Standard - 70mm Upstand	280	3000	61.55
DVU30VT110	071	790	Dry Fix Valley Over Batten - 110mm Upstand	400	3000	77.90
DVU30VT70	071	790	Dry Fix Valley Over Batten - 70mm Upstand	400	3000	77.90

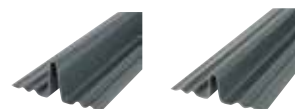

100mm upstand 70mm upstand

Universal Dry Fix Joining Gutter

Code	PG	Disc	Product Description	Width mm	Length mm	Price £
DBG30HW100	071	790	Dry Joining Gutter Heavyweight 100mm Upstand	240	3000	91.52
DBG30HW70	071	790	Dry Joining Gutter Heavyweight 70mm Upstand	240	3000	91.52

Code	PG	Disc	Product Description	Price £
DVBRACKET	071	790	Dry Valley Support Bracket Galvanised (pack of 5)	22.54

**Need a price?
Get a no obligation
quote today!**

For a no obligation quote on any Ariel product please contact our team now

T: 01246 561104

E: quotes@arielplastics.com

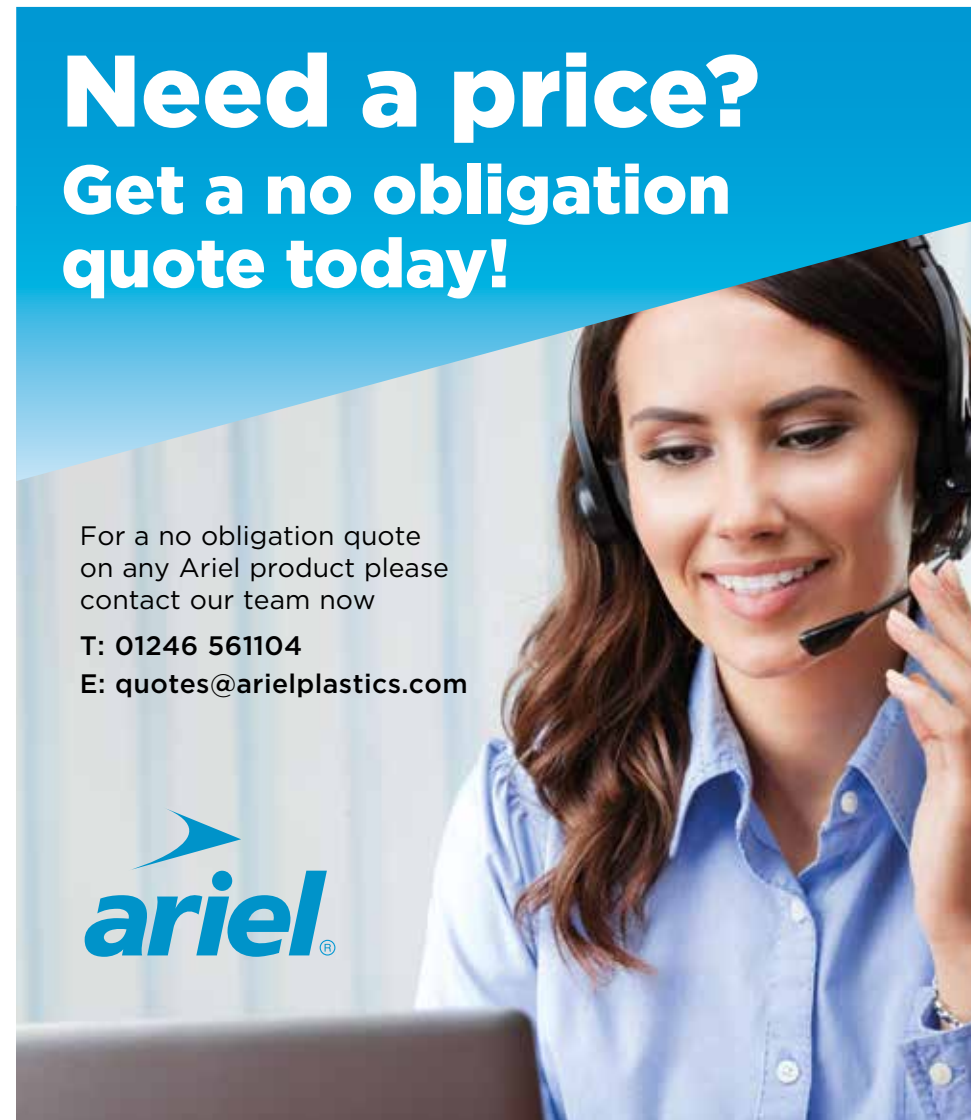

Coroverge

Universal Dry Verge System



Coroverge is a mortar free dry verge system which acts as a closure on the roof verge of houses, garages and porches to protect tiles from wind uplift, pest infestation and weather degradation in accordance with BS5534.

- 100% mortar free dry fix verge
- Fully adjustable for batten gauges of 260-350mm
- Hardwearing and durable
- Quick and easy to install
- Selection of popular colours

COLOURS AVAILABLE

- Anthracite Grey
- Brown
- Terracotta

APPLICATIONS

- House Roof Verge
- Garage Roof Verge
- Porch Roof Verge

Universal Dry Verge Components

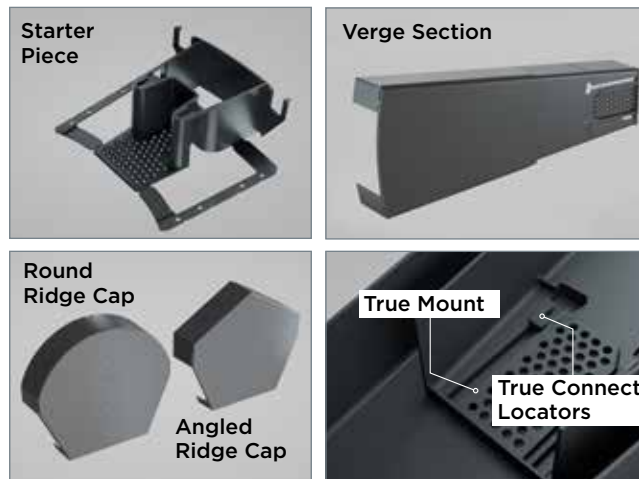

Manufactured from modern plastic material, Coroverge is very quick and easy to install.

Combining strength and resilience with an attractive finish, the Coroverge Dry Verge System is available in a selection of popular colours.

Universal Dry Verge System

Code	PG	Disc	Product Description	Colour	Price £
UVS/AG	071	051	Universal Dry Fix Verge Section	Anthracite Grey	6.33
UVS/BR	071	051	Universal Dry Fix Verge Section	Brown	6.33
UVS/TC	071	051	Universal Dry Fix Verge Section	Terracotta	6.33
UVSSP/AG	071	051	True Line Starter Piece	Anthracite Grey	7.96
UVSSP/BR	071	051	True Line Starter Piece	Brown	7.96
UVSSP/TC	071	051	True Line Starter Piece	Terracotta	7.96
UVSA/AG	071	051	Angled Ridge Cap	Anthracite Grey	8.86
UVSA/BR	071	051	Angled Ridge Cap	Brown	8.86
UVSA/TC	071	051	Angled Ridge Cap	Terracotta	8.86
UVSHR/AG	071	051	Half Round Ridge Cap	Anthracite Grey	9.30
UVSHR/BR	071	051	Half Round Ridge Cap	Brown	9.30
UVSHR/TC	071	051	Half Round Ridge Cap	Terracotta	9.30
UVS/BFIX	071	051	Batten End Clips Fixing Pack (Bag of 10)	S. Steel	40.39

uPVC Fascia & Soffit

A complete range of Fascia and Soffit products manufactured using the highest quality uPVC materials and available in a range of sizes and 9 colour options including the standard white or a selection of factory applied foiled woodgrain finishes for a seamless match across the roofline.

The boards are supplied with protective tape and with pre-marked centre-line and pin guides to make installation as simple as possible.



Replacement Fascia Boards

CODE	PG	DISC	PACK QTY#	DIMENSIONS	ITEM PRICE WHITE	ITEM PRICE* COLOUR
LRB150W	047	921	2	150mm x 20mm x 5m	£69.96	£122.70
LRB175W	047	921	2	175mm x 20mm x 5m	£81.43	£138.99
LRB200W	047	921	2	200mm x 20mm x 5m	£92.80	£155.28
LRB225W	047	921	2	225mm x 20mm x 5m	£104.18	£171.65
LRB250W	047	921	2	250mm x 20mm x 5m	£115.64	£187.93
LRB300W	047	921	2	300mm x 20mm x 5m	£138.40	£220.59
LRB354W	047	921	2	354mm x 20mm x 5m'	£164.57	£264.61
LRB454W	047	921	2	454mm x 20mm x 5m'	£210.19	£329.81
LRB454W125	047	921	1	454mm x 20mm x 1.25m'	£52.55	£82.48



Capping Fascia Boards

CODE	PG	DISC	PACK QTY#	DIMENSIONS	ITEM PRICE WHITE	ITEM PRICE* COLOUR
LCB150W	047	921	2	150mm x 9mm x 5m	£38.63	£100.53
LCB175W	047	921	2	175mm x 9mm x 5m	£44.11	£111.83
LCB200W	047	921	2	200mm x 9mm x 5m	£49.52	£123.21
LCB225W	047	921	2	225mm x 9mm x 5m	£54.91	£134.59
LCB250W	047	921	2	250mm x 9mm x 5m	£60.32	£145.89
LCB300W	047	921	2	300mm x 9mm x 5m	£71.12	£168.66
LCB354W	047	921	2	354mm x 9mm x 5m'	£88.97	£207.87
LCB454W	047	921	2	454mm x 9mm x 5m'	£110.68	£253.32
LCB454W125	047	921	1	454mm x 9mm x 1.25m'	£27.65	£63.32



Flat Boards

CODE	PG	DISC	PACK QTY#	DIMENSIONS	ITEM PRICE WHITE	ITEM PRICE* COLOUR
LFB150W	047	921	2	150mm x 9mm x 5m	£35.98	£84.66
LFB175W	047	921	2	175mm x 9mm x 5m	£41.87	£95.96
LFB200W	047	921	2	200mm x 9mm x 5m	£47.85	£107.34
LFB225W	047	921	2	225mm x 9mm x 5m	£53.84	£118.72
LFB250W	047	921	2	250mm x 9mm x 5m	£59.74	£130.04
LFB300W	047	921	2	300mm x 9mm x 5m	£71.70	£152.79
LFB354W	047	921	2	354mm x 9mm x 5m'	£84.73	£177.46
LFB454W	047	921	2	454mm x 9mm x 5m'	£108.58	£222.90



Order in pack quantities.

* To order colour items, replace letter 'W' in product code with relevant 2 letter code from Colour Options Table on page 18.

† These items are double-ended.

Vented Soffit Boards

CODE	PG	DISC	PACK QTY#	DIMENSIONS	ITEM PRICE WHITE	ITEM PRICE* COLOUR
LFBV150W	047	921	2	150mm x 9mm x 5m	£86.44	-
LFBV200W	047	921	2	200mm x 9mm x 5m	£97.97	-
LFBV250W	047	921	2	250mm x 9mm x 5m	£109.41	-
LFBV300W	047	921	2	300mm x 9mm x 5m	£120.93	-



Soffit Boards

CODE	PG	DISC	PACK QTY#	DIMENSIONS	ITEM PRICE WHITE	ITEM PRICE* COLOUR
LSB100W	047	921	10	100mm x 10mm x 5m	£15.26	£51.18
LSB300W	047	921	5	300mm x 10mm x 5m	£33.38	£119.96



Ancillary Items

CODE	PG	DISC	PACK QTY#	DIMENSIONS	ITEM PRICE WHITE	ITEM PRICE* COLOUR
LRM90CEW	047	921	10	90° External Corner	£8.63	£34.56
LRM90CIW	047	921	10	90° Internal Corner	£11.22	£44.93
LRM180JTW	047	921	10	In-Line Joint Trim	£11.22	£34.56
LRM135CEW	047	921	10	135° External Corner	£13.79	£55.25
LRM135CIW	047	921	10	135° Internal Corner	£15.53	£62.14
GFIW	047	921	10	Gable Finial	£6.06	£24.17
LFRT9W	047	921	10	Felt Roof Trim x 6m	£12.63	£38.72
LHJT9W	047	921	10	H Joint Trim x 6m	£15.13	£38.29
LJST9W	047	921	10	J Starter Trim x 6m	£15.87	£38.29
LFWT9W	047	921	10	F Wall Trim x 6m	£18.36	£40.79
PP30WH#	047	921	1	30mm Top Cap Pins (250)	£33.15	£33.15
PP40WH#	047	921	1	40mm Top Cap Pins (250)	£33.15	£33.07
PN65WH#	047	921	1	65mm Nails (100)	£35.58	£35.58



Order in pack quantities. * To order colour items, replace letter 'W' in product code with relevant 2 letter code from Colour Options Table on page 2. # PP30, PP40 & PN65 colour options - replace letters 'WH' in product code with BR (Brown), BL (Black), WZ (Anthracite Grey), LO (Light Oak), WG (Chartwell Green), WC (Cream).

Foam Trims & Architraves

CODE	PG	DISC	PACK QTY#	DIMENSIONS	ITEM PRICE WHITE	ITEM PRICE* COLOUR
LWTD24W	047	921	10	24mm D Mould Foam Trim x 5m	£5.24	£19.68
LWTCT18W	047	921	10	18mm Cloak Foam Trim x 5m	£6.14	£14.45
LWTCT28W	047	921	10	28mm Cloak Foam Trim x 5m	£7.48	£21.86
LWTQ135W	047	921	10	13.5mm Foam Quadrant x 5m	£4.82	£10.97
LWTQ185W	047	921	10	18.5mm Foam Quadrant x 5m	£6.99	£15.29
LWTB18W	047	921	10	18mm Chamfered Foam Bead x 5m	£7.90	£21.86
LWTARC45W	047	921	10	45mm x 6mm Foam Architrave x 5m	£7.90	£21.86
LWTARC65W	047	921	10	65mm x 6mm Foam Architrave x 5m	£11.38	£30.57
LWTARC95W	047	921	10	95mm x 6mm Foam Architrave x 5m	£18.36	£37.15
LWTAA50W	047	921	10	50mm Adjustable Angle x 5m	£15.62	£31.23
LWTAA75W	047	921	10	75mm Adjustable Angle x 5m	£20.43	£40.79



Corotherm

Polycarbonate Insulating Roofing Sheet

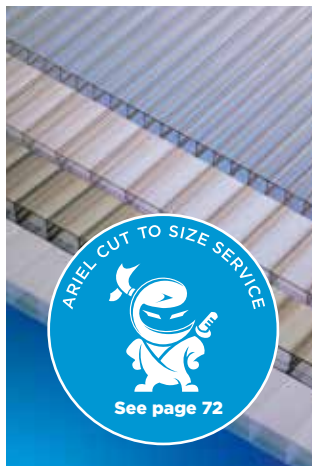

Corotherm multiwall polycarbonate sheet is a lightweight impact resistant glazing and roofing material suitable for use in a range of roofing assemblies with minimum 10° pitch.

- Range of tints, thicknesses & sheet sizes
- Very strong and resistant to impact
- Fire performance information available*
- Minimum condensation risk
- UV protected for durability
- Largely self-cleaning
- Limited warranty available*

* Speak to our Technical Department

TINTS AVAILABLE

- Clear
- Bronze
- Opal
- Bronze Opal
- Heatguard Opal

APPLICATIONS

- Conservatories
- Extensions
- Carports
- Porches
- Swimming Pool Covers

Ideal wherever heat insulation, reduced condensation, or simply a more attractive glazing material is required.

Whether you are installing a veranda, canopy or carport **Corotherm multiwall polycarbonate sheet is the ideal choice.** This lightweight impact resistant glazing material is easy to handle, cut and install. For use in projects around the home and garden, Corotherm sheets are available in a range of thicknesses in light transmitting and solar controlling tints.

KEY INSTALLATION POINTS

Make sure UV protected side of sheet is facing outwards.

Allow minimum of 10° roof slope for water drainage.

The Ariel purlin supported glazing bar and cap should be supported at intervals no greater than 1,500mm. See installer guide for full details.

Rafter glazing bars should be fully supported by rafters.

The lines of the flutes on the sheet must only run from the top to the bottom of the slope. They cannot be run from side to side.

Sheets cannot be joined top to bottom.

Glazing bars/F section cannot be joined - must be used as a continuous section.

When using F section run a suitable low-modulus silicone sealant down the inner top face of the enclosure before inserting sheet.

Watch Video Guide



View Installation Guide



Energy Efficiency - Relative U-Values*

Sheet Thickness (mm)	Corotherm	Single Glass	Double Glass	Argon Filled Cavity
6 (Twinwall)	3.7	5.7	2.65	1.6
10 (Twinwall)	3.2	5.6	2.65	1.6
16 (Triplewall)	2.4	5.4	2.65	1.6
25 (Sevenwall)	1.4	-	2.65	1.6

*A lower U-value indicates increased energy efficiency and thermal insulation

ACCESSORIES



Rafter Glazing Bar Cap & Base
 Glazing Bar Base
 Glazing Bar End Cap
 Glazing Bar Cap
 Side Flashing
 End Cap
 Fixing Button
 Breather Tape
 Aluminium Sealing Tape



4mm Clear Twinwall

4mm for side cladding only, not suitable for roofing

Code	PG	Disc	Product Description	Width mm	Length mm	Price £
76880	030	762	Corotherm Clear Twinwall Sheet	610	1220	16.59
76881	030	762	Corotherm Clear Twinwall Sheet	1220	1220	32.87

6mm Clear Twinwall

6mm for side cladding only, not suitable for roofing

Code	PG	Disc	Product Description	Width mm	Length mm	Price £
76265	030	762	Corotherm Clear Twinwall Sheet	1050	6000	226.80
76160	030	762	Corotherm Clear Twinwall Sheet	2100	6000	453.59

10mm Clear Twinwall

Code	PG	Disc	Product Description	Width mm	Length mm	Price £
76104	030	763	Corotherm Clear Twinwall Sheet	700	2000	72.78
76523	030	763	Corotherm Clear Twinwall Sheet	700	2500	90.95
76100	030	763	Corotherm Clear Twinwall Sheet	700	3000	109.17
76238	030	763	Corotherm Clear Twinwall Sheet	700	4000	145.55
76525	030	763	Corotherm Clear Twinwall Sheet	700	6000	218.31
76624	030	763	Corotherm Clear Twinwall Sheet	900	2000	93.60
76610	030	763	Corotherm Clear Twinwall Sheet	900	2500	116.90
76664	030	763	Corotherm Clear Twinwall Sheet	900	3000	140.33
76607	030	763	Corotherm Clear Twinwall Sheet	900	4000	187.12
76608	030	763	Corotherm Clear Twinwall Sheet	900	6000	280.66
76653	030	763	Corotherm Clear Twinwall Sheet	980	2000	101.87
76650	030	763	Corotherm Clear Twinwall Sheet	980	2500	127.36
76654	030	763	Corotherm Clear Twinwall Sheet	980	3000	152.82
76655	030	763	Corotherm Clear Twinwall Sheet	980	4000	203.73
76652	030	763	Corotherm Clear Twinwall Sheet	980	6000	305.63
76215	030	763	Corotherm Clear Twinwall Sheet	1050	2000	109.17
76218	030	763	Corotherm Clear Twinwall Sheet	1050	2500	136.46
76230	030	763	Corotherm Clear Twinwall Sheet	1050	3000	163.73
76245	030	763	Corotherm Clear Twinwall Sheet	1050	4000	218.31
76260	030	763	Corotherm Clear Twinwall Sheet	1050	6000	327.45
76782	030	763	Corotherm Clear Twinwall Sheet	1220	2000	126.80
76697	030	763	Corotherm Clear Twinwall Sheet	1220	2500	158.52
76790	030	763	Corotherm Clear Twinwall Sheet	1220	3000	190.23
76820	030	763	Corotherm Clear Twinwall Sheet	1220	4000	253.63
76764	030	763	Corotherm Clear Twinwall Sheet	1220	6000	380.49

10mm Clear Twinwall

Code	PG	Disc	Product Description	Width mm	Length mm	Price £
76637	030	763	Corotherm Clear Twinwall Sheet	1600	2000	166.31
76331	030	763	Corotherm Clear Twinwall Sheet	1600	2500	207.91
76645	030	763	Corotherm Clear Twinwall Sheet	1600	3000	249.49
76625	030	763	Corotherm Clear Twinwall Sheet	1600	4000	332.62
76307	030	763	Corotherm Clear Twinwall Sheet	1600	6000	498.98
76170	030	763	Corotherm Clear Twinwall Sheet	2100	2000	218.31
76520	030	763	Corotherm Clear Twinwall Sheet	2100	2500	272.89
76185	030	763	Corotherm Clear Twinwall Sheet	2100	3000	327.45
76200	030	763	Corotherm Clear Twinwall Sheet	2100	4000	436.60
76155	030	763	Corotherm Clear Twinwall Sheet	2100	6000	654.88

10mm Bronze Twinwall

Code	PG	Disc	Product Description	Width mm	Length mm	Price £
76216	030	765	Corotherm Bronze Twinwall Sheet	1050	2000	114.60
76231	030	765	Corotherm Bronze Twinwall Sheet	1050	3000	171.93
76246	030	765	Corotherm Bronze Twinwall Sheet	1050	4000	229.27
76261	030	765	Corotherm Bronze Twinwall Sheet	1050	6000	343.88
76171	030	765	Corotherm Bronze Twinwall Sheet	2100	2000	216.30
76186	030	765	Corotherm Bronze Twinwall Sheet	2100	3000	343.88
76201	030	765	Corotherm Bronze Twinwall Sheet	2100	4000	458.50
76156	030	765	Corotherm Bronze Twinwall Sheet	2100	6000	687.78

16mm Clear Triplewall

Code	PG	Disc	Product Description	Width mm	Length mm	Price £
76876	030	764	Corotherm Clear Triplewall Sheet	610	2000	94.39
76849	030	764	Corotherm Clear Triplewall Sheet	610	2500	117.99
76874	030	764	Corotherm Clear Triplewall Sheet	610	3000	141.56
76898	030	764	Corotherm Clear Triplewall Sheet	610	4000	188.76
76899	030	764	Corotherm Clear Triplewall Sheet	610	6000	283.12
76709	030	764	Corotherm Clear Triplewall Sheet	700	2000	108.28
76543	030	764	Corotherm Clear Triplewall Sheet	700	2500	135.36
76103	030	764	Corotherm Clear Triplewall Sheet	700	3000	162.46
76251	030	764	Corotherm Clear Triplewall Sheet	700	4000	216.60



16mm Clear Triplewall

Code	PG	Disc	Product Description	Width mm	Length mm	Price £
76630	030	764	Corotherm Clear Triplewall Sheet	800	2000	123.78
76364	030	764	Corotherm Clear Triplewall Sheet	800	2500	154.71
76679	030	764	Corotherm Clear Triplewall Sheet	800	3000	185.70
76286	030	764	Corotherm Clear Triplewall Sheet	800	4000	247.55
76900	030	764	Corotherm Clear Triplewall Sheet	800	6000	371.29
76671	030	764	Corotherm Clear Triplewall Sheet	900	2000	139.23
76639	030	764	Corotherm Clear Triplewall Sheet	900	2500	174.06
76613	030	764	Corotherm Clear Triplewall Sheet	900	3000	208.88
76620	030	764	Corotherm Clear Triplewall Sheet	900	4000	278.50
76612	030	764	Corotherm Clear Triplewall Sheet	900	6000	417.70
76659	030	764	Corotherm Clear Triplewall Sheet	980	2000	151.59
76656	030	764	Corotherm Clear Triplewall Sheet	980	2500	189.47
76660	030	764	Corotherm Clear Triplewall Sheet	980	3000	227.43
76661	030	764	Corotherm Clear Triplewall Sheet	980	4000	303.26
76658	030	764	Corotherm Clear Triplewall Sheet	980	6000	454.88
76210	030	764	Corotherm Clear Triplewall Sheet	1050	2000	162.46
76521	030	764	Corotherm Clear Triplewall Sheet	1050	2500	203.07
76225	030	764	Corotherm Clear Triplewall Sheet	1050	3000	243.70
76240	030	764	Corotherm Clear Triplewall Sheet	1050	4000	324.84
76255	030	764	Corotherm Clear Triplewall Sheet	1050	6000	487.34
76841	030	764	Corotherm Clear Triplewall Sheet	1220	2000	188.76
76766	030	764	Corotherm Clear Triplewall Sheet	1220	2500	235.91
76715	030	764	Corotherm Clear Triplewall Sheet	1220	3000	283.12
76769	030	764	Corotherm Clear Triplewall Sheet	1220	4000	377.48
76758	030	764	Corotherm Clear Triplewall Sheet	1220	6000	566.23
76621	030	764	Corotherm Clear Triplewall Sheet	1600	2000	247.54
76674	030	764	Corotherm Clear Triplewall Sheet	1600	2500	309.43
76616	030	764	Corotherm Clear Triplewall Sheet	1600	3000	371.32
76614	030	764	Corotherm Clear Triplewall Sheet	1600	4000	495.11
76316	030	764	Corotherm Clear Triplewall Sheet	1600	6000	742.62
76165	030	764	Corotherm Clear Triplewall Sheet	2100	2000	306.46
76540	030	764	Corotherm Clear Triplewall Sheet	2100	2500	406.13
76180	030	764	Corotherm Clear Triplewall Sheet	2100	3000	487.34
76195	030	764	Corotherm Clear Triplewall Sheet	2100	4000	649.80
76150	030	764	Corotherm Clear Triplewall Sheet	2100	6000	974.74



16mm Bronze Triplewall

Code	PG	Disc	Product Description	Width mm	Length mm	Price £
76918	030	766	Corotherm Bronze Triplewall Sheet	610	2000	99.14
76919	030	766	Corotherm Bronze Triplewall Sheet	610	2500	123.88
76845	030	766	Corotherm Bronze Triplewall Sheet	610	3000	148.64
77112	030	766	Corotherm Bronze Triplewall Sheet	610	4000	198.19
77073	030	766	Corotherm Bronze Triplewall Sheet	610	6000	297.26
76234	030	766	Corotherm Bronze Triplewall Sheet	700	2000	113.74
76707	030	766	Corotherm Bronze Triplewall Sheet	700	2500	142.15
76183	030	766	Corotherm Bronze Triplewall Sheet	700	3000	170.56
76239	030	766	Corotherm Bronze Triplewall Sheet	700	4000	227.43
76106	030	766	Corotherm Bronze Triplewall Sheet	700	6000	341.18
76871	030	766	Corotherm Bronze Triplewall Sheet	800	2000	129.94
76867	030	766	Corotherm Bronze Triplewall Sheet	800	2500	162.45
76846	030	766	Corotherm Bronze Triplewall Sheet	800	3000	194.91
76792	030	766	Corotherm Bronze Triplewall Sheet	800	4000	259.91
76971	030	766	Corotherm Bronze Triplewall Sheet	800	6000	389.89
76852	030	766	Corotherm Bronze Triplewall Sheet	900	2000	146.23
76746	030	766	Corotherm Bronze Triplewall Sheet	900	2500	182.77
76755	030	766	Corotherm Bronze Triplewall Sheet	900	3000	219.31
76796	030	766	Corotherm Bronze Triplewall Sheet	900	4000	292.40
76635	030	766	Corotherm Bronze Triplewall Sheet	900	6000	438.63
76756	030	766	Corotherm Bronze Triplewall Sheet	980	2000	159.17
76213	030	766	Corotherm Bronze Triplewall Sheet	980	2500	199.02
76761	030	766	Corotherm Bronze Triplewall Sheet	980	3000	238.83
76767	030	766	Corotherm Bronze Triplewall Sheet	980	4000	318.38
77183	030	766	Corotherm Bronze Triplewall Sheet	980	6000	477.63
76211	030	766	Corotherm Bronze Triplewall Sheet	1050	2000	170.56
76248	030	766	Corotherm Bronze Triplewall Sheet	1050	2500	213.20
76226	030	766	Corotherm Bronze Triplewall Sheet	1050	3000	255.86
76241	030	766	Corotherm Bronze Triplewall Sheet	1050	4000	341.18
76256	030	766	Corotherm Bronze Triplewall Sheet	1050	6000	511.72
76768	030	766	Corotherm Bronze Triplewall Sheet	1220	2000	198.19
77074	030	766	Corotherm Bronze Triplewall Sheet	1220	2500	247.72
76704	030	766	Corotherm Bronze Triplewall Sheet	1220	3000	297.26
76754	030	766	Corotherm Bronze Triplewall Sheet	1220	4000	396.36
77236	030	766	Corotherm Bronze Triplewall Sheet	1220	6000	594.57



16mm Bronze Triplewall

Code	PG	Disc	Product Description	Width mm	Length mm	Price £
76786	030	766	Corotherm Bronze Triplewall Sheet	1600	2000	259.91
76757	030	766	Corotherm Bronze Triplewall Sheet	1600	2500	324.93
76789	030	766	Corotherm Bronze Triplewall Sheet	1600	3000	389.89
77115	030	766	Corotherm Bronze Triplewall Sheet	1600	4000	519.85
76743	030	766	Corotherm Bronze Triplewall Sheet	1600	6000	779.73
76166	030	766	Corotherm Bronze Triplewall Sheet	2100	2000	321.83
76214	030	766	Corotherm Bronze Triplewall Sheet	2100	2500	426.44
76181	030	766	Corotherm Bronze Triplewall Sheet	2100	3000	511.72
76178	030	766	Corotherm Bronze Triplewall Sheet	2100	4000	682.30
76151	030	766	Corotherm Bronze Triplewall Sheet	2100	6000	1,023.46

16mm Opal Triplewall

Code	PG	Disc	Product Description	Width mm	Length mm	Price £
76934	030	766	Corotherm Opal Triplewall Sheet	610	2000	99.14
77375	030	766	Corotherm Opal Triplewall Sheet	610	2500	123.88
77053	030	766	Corotherm Opal Triplewall Sheet	610	3000	148.64
77080	030	766	Corotherm Opal Triplewall Sheet	610	4000	198.19
606116OH	030	766	Corotherm Opal Triplewall Sheet	610	6000	297.26
76742	030	766	Corotherm Opal Triplewall Sheet	700	2000	113.74
77262	030	766	Corotherm Opal Triplewall Sheet	700	2500	142.15
76233	030	766	Corotherm Opal Triplewall Sheet	700	3000	170.56
77082	030	766	Corotherm Opal Triplewall Sheet	700	4000	227.43
607016OH	030	766	Corotherm Opal Triplewall Sheet	700	6000	341.18
76793	030	766	Corotherm Opal Triplewall Sheet	800	2000	129.94
77018	030	766	Corotherm Opal Triplewall Sheet	800	2500	162.45
77266	030	766	Corotherm Opal Triplewall Sheet	800	3000	194.91
76954	030	766	Corotherm Opal Triplewall Sheet	800	4000	259.91
77187	030	766	Corotherm Opal Triplewall Sheet	800	6000	389.89
77113	030	766	Corotherm Opal Triplewall Sheet	900	2000	146.23
76873	030	766	Corotherm Opal Triplewall Sheet	900	2500	182.77
76972	030	766	Corotherm Opal Triplewall Sheet	900	3000	219.31
77184	030	766	Corotherm Opal Triplewall Sheet	900	4000	292.40
609016OH	030	766	Corotherm Opal Triplewall Sheet	900	6000	438.63



16mm Opal Triplewall

Code	PG	Disc	Product Description	Width mm	Length mm	Price £
77086	030	766	Corotherm Opal Triplewall Sheet	980	2000	159.17
77119	030	766	Corotherm Opal Triplewall Sheet	980	2500	199.02
76810	030	766	Corotherm Opal Triplewall Sheet	980	3000	238.83
76981	030	766	Corotherm Opal Triplewall Sheet	980	4000	318.38
77281	030	766	Corotherm Opal Triplewall Sheet	980	6000	477.63
76212	030	766	Corotherm Opal Triplewall Sheet	1050	2000	170.56
77027	030	766	Corotherm Opal Triplewall Sheet	1050	2500	213.20
76227	030	766	Corotherm Opal Triplewall Sheet	1050	3000	255.86
76242	030	766	Corotherm Opal Triplewall Sheet	1050	4000	341.18
76257	030	766	Corotherm Opal Triplewall Sheet	1050	6000	511.72
76994	030	766	Corotherm Opal Triplewall Sheet	1220	2000	198.19
77191	030	766	Corotherm Opal Triplewall Sheet	1220	2500	247.72
76847	030	766	Corotherm Opal Triplewall Sheet	1220	3000	297.26
77195	030	766	Corotherm Opal Triplewall Sheet	1220	4000	396.36
76676	030	766	Corotherm Opal Triplewall Sheet	1220	6000	594.57
77088	030	766	Corotherm Opal Triplewall Sheet	1600	2000	259.91
77224	030	766	Corotherm Opal Triplewall Sheet	1600	2500	324.93
77081	030	766	Corotherm Opal Triplewall Sheet	1600	3000	389.89
77208	030	766	Corotherm Opal Triplewall Sheet	1600	4000	519.85
77149	030	766	Corotherm Opal Triplewall Sheet	1600	6000	779.73
76167	030	766	Corotherm Opal Triplewall Sheet	2100	2000	321.83
76727	030	766	Corotherm Opal Triplewall Sheet	2100	2500	426.44
76182	030	766	Corotherm Opal Triplewall Sheet	2100	3000	511.72
79196	030	766	Corotherm Opal Triplewall Sheet	2100	4000	682.30
76152	030	766	Corotherm Opal Triplewall Sheet	2100	6000	1,023.46



25mm Clear Sevenwall

Code	PG	Disc	Product Description	Width mm	Length mm	Price £
2070255CH	030	900	Corotherm Clear Sheet	700	2000	140.44
2570255CH	030	900	Corotherm Clear Sheet	700	2500	175.56
3070255CH	030	900	Corotherm Clear Sheet	700	3000	210.66
4070255CH	030	900	Corotherm Clear Sheet	700	4000	280.88
6070255CH	030	900	Corotherm Clear Sheet	700	6000	421.29
2080255CH	030	900	Corotherm Clear Sheet	800	2000	160.50
2580255CH	030	900	Corotherm Clear Sheet	800	2500	200.64
3080255CH	030	900	Corotherm Clear Sheet	800	3000	240.74
4080255CH	030	900	Corotherm Clear Sheet	800	4000	321.01
6080255CH	030	900	Corotherm Clear Sheet	800	6000	481.50
2090255CH	030	900	Corotherm Clear Sheet	900	2000	180.56
2590255CH	030	900	Corotherm Clear Sheet	900	2500	225.66
3090255CH	030	900	Corotherm Clear Sheet	900	3000	270.80
4090255CH	030	900	Corotherm Clear Sheet	900	4000	361.12
6090255CH	030	900	Corotherm Clear Sheet	900	6000	541.68
2010255CH	030	900	Corotherm Clear Sheet	1050	2000	210.66
2510255CH	030	900	Corotherm Clear Sheet	1050	2500	263.29
3010255CH	030	900	Corotherm Clear Sheet	1050	3000	316.01
4010255CH	030	900	Corotherm Clear Sheet	1050	4000	421.29
6010255CH	030	900	Corotherm Clear Sheet	1050	6000	631.97
2016255CH	030	900	Corotherm Clear Sheet	1600	2000	321.01
2516255CH	030	900	Corotherm Clear Sheet	1600	2500	401.21
3016255CH	030	900	Corotherm Clear Sheet	1600	3000	481.50
4016255CH	030	900	Corotherm Clear Sheet	1600	4000	641.99
6016255CH	030	900	Corotherm Clear Sheet	1600	6000	963.03
2021255CH	030	900	Corotherm Clear Sheet	2100	2000	421.29
2521255CH	030	900	Corotherm Clear Sheet	2100	2500	526.64
3021255CH	030	900	Corotherm Clear Sheet	2100	3000	631.97
4021255CH	030	900	Corotherm Clear Sheet	2100	4000	842.61
6021255CH	030	900	Corotherm Clear Sheet	2100	6000	1,263.93



25mm Bronze Sevenwall

Code	PG	Disc	Product Description	Width mm	Length mm	Price £
2070255BH	030	901	Corotherm Bronze Sheet	700	2000	147.46
2570255BH	030	901	Corotherm Bronze Sheet	700	2500	184.32
3070255BH	030	901	Corotherm Bronze Sheet	700	3000	221.19
4070255BH	030	901	Corotherm Bronze Sheet	700	4000	294.92
6070255BH	030	901	Corotherm Bronze Sheet	700	6000	442.39
2080255BH	030	901	Corotherm Bronze Sheet	800	2000	168.50
2580255BH	030	901	Corotherm Bronze Sheet	800	2500	210.66
3080255BH	030	901	Corotherm Bronze Sheet	800	3000	252.78
4080255BH	030	901	Corotherm Bronze Sheet	800	4000	337.03
6080255BH	030	901	Corotherm Bronze Sheet	800	6000	505.56
2090255BH	030	901	Corotherm Bronze Sheet	900	2000	189.59
2590255BH	030	901	Corotherm Bronze Sheet	900	2500	236.96
3090255BH	030	901	Corotherm Bronze Sheet	900	3000	284.38
4090255BH	030	901	Corotherm Bronze Sheet	900	4000	379.23
6090255BH	030	901	Corotherm Bronze Sheet	900	6000	568.81
2010255BH	030	901	Corotherm Bronze Sheet	1050	2000	221.19
2510255BH	030	901	Corotherm Bronze Sheet	1050	2500	276.51
3010255BH	030	901	Corotherm Bronze Sheet	1050	3000	331.77
4010255BH	030	901	Corotherm Bronze Sheet	1050	4000	442.39
6010255BH	030	901	Corotherm Bronze Sheet	1050	6000	663.56
2016255BH	030	901	Corotherm Bronze Sheet	1600	2000	337.03
2516255BH	030	901	Corotherm Bronze Sheet	1600	2500	421.29
3016255BH	030	901	Corotherm Bronze Sheet	1600	3000	505.56
4016255BH	030	901	Corotherm Bronze Sheet	1600	4000	674.09
6016255BH	030	901	Corotherm Bronze Sheet	1600	6000	1,011.15
2021255BH	030	901	Corotherm Bronze Sheet	2100	2000	442.39
2521255BH	030	901	Corotherm Bronze Sheet	2100	2500	553.00
3021255BH	030	901	Corotherm Bronze Sheet	2100	3000	663.56
4021255BH	030	901	Corotherm Bronze Sheet	2100	4000	884.75
6021255BH	030	901	Corotherm Bronze Sheet	2100	6000	1,327.16



25mm Opal Sevenwall

Code	PG	Disc	Product Description	Width mm	Length mm	Price £
2070255OH	030	901	Corotherm Opal Sheet	700	2000	147.46
2570255OH	030	901	Corotherm Opal Sheet	700	2500	184.32
3070255OH	030	901	Corotherm Opal Sheet	700	3000	221.19
4070255OH	030	901	Corotherm Opal Sheet	700	4000	294.92
6070255OH	030	901	Corotherm Opal Sheet	700	6000	442.39
2080255OH	030	901	Corotherm Opal Sheet	800	2000	168.50
2580255OH	030	901	Corotherm Opal Sheet	800	2500	210.66
3080255OH	030	901	Corotherm Opal Sheet	800	3000	252.78
4080255OH	030	901	Corotherm Opal Sheet	800	4000	366.16
6080255OH	030	901	Corotherm Opal Sheet	800	6000	505.56
2090255OH	030	901	Corotherm Opal Sheet	900	2000	189.59
2590255OH	030	901	Corotherm Opal Sheet	900	2500	236.96
3090255OH	030	901	Corotherm Opal Sheet	900	3000	284.38
4090255OH	030	901	Corotherm Opal Sheet	900	4000	379.23
6090255OH	030	901	Corotherm Opal Sheet	900	6000	568.81
2010255OH	030	901	Corotherm Opal Sheet	1050	2000	221.19
2510255OH	030	901	Corotherm Opal Sheet	1050	2500	276.51
3010255OH	030	901	Corotherm Opal Sheet	1050	3000	331.77
4010255OH	030	901	Corotherm Opal Sheet	1050	4000	442.39
6010255OH	030	901	Corotherm Opal Sheet	1050	6000	663.56
2016255OH	030	901	Corotherm Opal Sheet	1600	2000	337.03
2516255OH	030	901	Corotherm Opal Sheet	1600	2500	421.29
3016255OH	030	901	Corotherm Opal Sheet	1600	3000	505.56
4016255OH	030	901	Corotherm Opal Sheet	1600	4000	674.09
6016255OH	030	901	Corotherm Opal Sheet	1600	6000	1,011.15
2021255OH	030	901	Corotherm Opal Sheet	2100	2000	442.39
2521255OH	030	901	Corotherm Opal Sheet	2100	2500	553.00
3021255OH	030	901	Corotherm Opal Sheet	2100	3000	663.56
4021255OH	030	901	Corotherm Opal Sheet	2100	4000	884.75
6021255OH	030	901	Corotherm Opal Sheet	2100	6000	1,327.16



25mm Bronze Opal Sevenwall

Code	PG	Disc	Product Description	Width mm	Length mm	Price £
2070255BOH	030	902	Corotherm Bronze Opal Sheet	700	2000	161.57
2570255BOH	030	902	Corotherm Bronze Opal Sheet	700	2500	201.88
3070255BOH	030	902	Corotherm Bronze Opal Sheet	700	3000	242.29
4070255BOH	030	902	Corotherm Bronze Opal Sheet	700	4000	323.02
6070255BOH	030	902	Corotherm Bronze Opal Sheet	700	6000	484.51
2010255BOH	030	902	Corotherm Bronze Opal Sheet	1050	2000	242.29
2510255BOH	030	902	Corotherm Bronze Opal Sheet	1050	2500	302.83
3010255BOH	030	902	Corotherm Bronze Opal Sheet	1050	3000	363.34
4010255BOH	030	902	Corotherm Bronze Opal Sheet	1050	4000	484.51
6010255BOH	030	902	Corotherm Bronze Opal Sheet	1050	6000	726.76
2021255BOH	030	902	Corotherm Bronze Opal Sheet	2100	2000	484.51
2521255BOH	030	902	Corotherm Bronze Opal Sheet	2100	2500	605.64
3021255BOH	030	902	Corotherm Bronze Opal Sheet	2100	3000	726.76
4021255BOH	030	902	Corotherm Bronze Opal Sheet	2100	4000	969.01
6021255BOH	030	902	Corotherm Bronze Opal Sheet	2100	6000	1,453.53

25mm Heatguard Opal Sevenwall

Code	PG	Disc	Product Description	Width mm	Length mm	Price £
2070255HOH	030	902	Corotherm Heatguard Opal Sheet	700	2000	161.57
2570255HOH	030	902	Corotherm Heatguard Opal Sheet	700	2500	201.88
3070255HOH	030	902	Corotherm Heatguard Opal Sheet	700	3000	242.29
4070255HOH	030	902	Corotherm Heatguard Opal Sheet	700	4000	323.02
6070255HOH	030	902	Corotherm Heatguard Opal Sheet	700	6000	484.51
2010255HOH	030	902	Corotherm Heatguard Opal Sheet	1050	2000	242.29
2510255HOH	030	902	Corotherm Heatguard Opal Sheet	1050	2500	302.83
3010255HOH	030	902	Corotherm Heatguard Opal Sheet	1050	3000	363.34
4010255HOH	030	902	Corotherm Heatguard Opal Sheet	1050	4000	484.51
6010255HOH	030	902	Corotherm Heatguard Opal Sheet	1050	6000	726.76
2021255HOH	030	902	Corotherm Heatguard Opal Sheet	2100	2000	484.51
2521255HOH	030	902	Corotherm Heatguard Opal Sheet	2100	2500	605.64
3021255HOH	030	902	Corotherm Heatguard Opal Sheet	2100	3000	726.76
4021255HOH	030	902	Corotherm Heatguard Opal Sheet	2100	4000	969.01
6021255HOH	030	902	Corotherm Heatguard Opal Sheet	2100	6000	1,453.53

Accessories Multiwall polycarbonat

Code	PG	Disc	Standard Rafter Glazing Bar Kit (for 10/16mm sheet only)	Colour	Length mm	Price £
76486	045	761	Rafter Glazing bar cap, base & end cap	White	3000	79.67
76551	045	761	Rafter Glazing bar cap, base & end cap	White	4000	104.83
BSYT	045	761	Rafter Glazing bar cap, base & end cap	White	6000	155.12
Code	PG	Disc	Aluminium Purlin Supported Glazing Bar Base (for 10/16mm sheet only)	Colour	Length mm	Price £
76118	045	761	Glazing bar base - used with cap	Alumin.	3000	65.55
76119	045	761	Glazing bar base - used with cap	Alumin.	4000	87.33
76347	045	761	Glazing bar base - used with cap	Alumin.	6000	130.98
Code	PG	Disc	PVC Purlin Supported Glazing Bar Top Cap (for 10/16mm sheet only)	Colour	Length mm	Price £
76110	045	761	Glazing bar cap - used with base	White	3000	28.85
76111	045	761	Glazing bar cap - used with base	White	4000	38.49
76348	045	761	Glazing bar cap - used with base	White	6000	57.67
76460	045	761	Glazing bar cap - used with base	Brown	3000	38.09
76461	045	761	Glazing bar cap - used with base	Brown	4000	50.74
76468	045	761	Glazing bar cap - used with base	Brown	6000	76.13
Code	PG	Disc	Glazing Bar End Cap	Colour	Length	Price £
76489	045	761	10/16/25mm Glazing Bar End Cap	White	-	4.13
Code	PG	Disc	Universal Rafter Glazing Bar Kit (10/16/25mm sheet)	Colour	Length mm	Price £
BHPO	045	761	Glazing bar cap & base - with end cap	White	3000	102.66
BHPR	045	761	Glazing bar cap & base - with end cap	White	4000	135.91
BHOR	045	761	Glazing bar cap & base - with end cap	White	6000	202.73
BJOP	045	761	Glazing bar cap & base - with end cap	Brown	3000	106.60
BYTO	045	761	Glazing bar cap & base - with end cap	Brown	4000	141.33
BGTY	045	761	Glazing bar cap & base - with end cap	Brown	6000	210.21
Code	PG	Disc	Side Flashings	Colour	Length mm	Price £
76112	045	761	10mm Side Flashing	White	3000	25.31
76113	045	761	10mm Side Flashing	White	4000	33.72
76346	045	761	10mm Side Flashing	White	6000	50.60
76342	045	761	10mm Side Flashing	Brown	3000	31.68
76343	045	761	10mm Side Flashing	Brown	4000	42.12
76466	045	761	10mm Side Flashing	Brown	6000	63.25
76114	045	761	16mm Side Flashing	White	3000	25.31
76115	045	761	16mm Side Flashing	White	4000	33.72
76341	045	761	16mm Side Flashing	White	6000	50.60
76463	045	761	16mm Side Flashing	Brown	3000	31.68
76464	045	761	16mm Side Flashing	Brown	4000	42.12
76465	045	761	16mm Side Flashing	Brown	6000	63.25

Accessories Multiwall polycarbonat

Code	PG	Disc	Side Flashings	Colour	Length mm	Price £
BCOS	045	761	25mm Side Flashing	White	3000	38.71
BMOJ	045	761	25mm Side Flashing	White	4000	51.34
BGVV	045	761	25mm Side Flashing	White	6000	76.63
BYKZ	045	761	25mm Side Flashing	Brown	3000	42.12
BHSS	045	761	25mm Side Flashing	Brown	4000	56.26
BPWP	045	761	25mm Side Flashing	Brown	6000	84.09
Code	PG	Disc	Sheet End Closures	Colour	Length mm	Price £
76123	045	761	6mm Sheet End Closure - pack of 2	Clear	2100	24.05
76116	045	761	10mm Sheet End Closure - pack of 2	White	2100	24.05
76462	045	761	10mm Sheet End Closure - pack of 2	Brown	2100	30.62
76117	045	761	16mm Sheet End Closure - pack of 2	White	2100	24.05
76467	045	761	16mm Sheet End Closure - pack of 2	Brown	2100	30.62
BRBP	045	761	25mm Sheet End Closure - pack of 2	White	2100	33.98
BRTU	045	761	25mm Sheet End Closure - pack of 2	Brown	2100	37.31
Code	PG	Disc	Glazing Bar End Cap	Colour	Length	Price £
76489	045	761	10/16/25mm Glazing Bar End Cap	White	-	4.13
Code	PG	Disc	Fixing Buttons	Colour	Length	Price £
76567	045	761	10mm Super Fixing Buttons - Pack of 10	White	-	28.21
76569	045	761	10mm Super Fixing Buttons - Pack of 10	Brown	-	28.21
76568	045	761	16mm Super Fixing Buttons - Pack of 10	White	-	28.21
76570	045	761	16mm Super Fixing Buttons - Pack of 10	Brown	-	28.21
BVUT	045	761	25mm Super Fixing Buttons - Pack of 10	White	-	29.22
BHUP	045	761	25mm Super Fixing Buttons - Pack of 10	Brown	-	29.22
Code	PG	Disc	Tapes & Sealants	Colour	Length mm	Price £
BSTP	045	761	10/16mm Breather Tape (38mm x 10m)	Grey	10,000	44.51
BMNO	045	761	10/16mm Aluminium Sealing Tape	Alumin.	10,000	9.58
BVTP	045	761	25mm Breather Tape (45mm x 10m)	Grey	10,000	52.07
BZOP	045	761	25mm Aluminium Sealing Tape (45mm x 10m)	Alumin.	10,000	11.29
76585	045	761	Flashing Tape (225mm x 10m)	Grey	10,000	102.84
76590	045	761	Low Modulus Silicone Sealant (310ml)	White	-	18.77



Self supporting roofing system



A professionally engineered **Self Supporting Roofing System** which free-spans 4.0m and accommodates 16mm, 25mm and 35mm Corotherm Multiwall Polycarbonate Roofing sheets (pg 20-31).

APPLICATIONS

- Carports
- Canopies
- Conservatories
- Replacement Roofing



- Professionally engineered
- Innovative design
- Accommodates 16, 25 & 35mm sheet
- Easy to install
- Low maintenance

Designed with flexibility in mind, this lean-to roofing system is suitable for a wide variety of applications. Easy to install and available in a range of sizes - the Self Supporting Roofing System is the tradesman's choice.

Self Supporting Posts

Code	PG	Disc	Product Description	Colour	Price £
SSGP2	046	920	Self Supporting Goal Posts 2.4m (pack of 2)	White	480.35

Intermediate Bars*

Aluminium Glazing Bar with co-extruded PVC underclad and top capping

Code	PG	Disc	Product Description	Colour	Price £
SSBI25	046	920	2.5m Intermediate Bar	White	216.01
SSBI30	046	920	3.0m Intermediate Bar	White	259.07
SSBI35	046	920	3.5m Intermediate Bar	White	301.45
SSBI40	046	920	4.0m Intermediate Bar	White	345.45

*End caps included

End Bars*

Aluminium Glazing Bar with co-extruded PVC underclad and top capping

Code	PG	Disc	Product Description	Colour	Price £
SSBE25	046	920	2.5m End Bars	White	215.95
SSBE30	046	920	3.0m End Bars	White	259.07
SSBE35	046	920	3.5m End Bars	White	302.31
SSBE40	046	920	4.0m End Bars	White	345.45

*End caps included

End Caps

Code	PG	Disc	Product Description	Colour	Price £
SSEC	046	920	Bar End Caps	White	26.69

Wall Plates - Aluminium Wall Plate with PVC underclad and flashing

Code	PG	Disc	Product Description	Colour	Price £
SSBW30	046	920	3.0m Wall Plate	White	400.20
SSBW40	046	920	4.0m Wall Plate	White	533.59
SSBW50	046	920	5.0m Wall Plate	White	667.01

Standard Eaves Beam - Aluminium Eaves Beam with PVC Cladding

Code	PG	Disc	Product Description	Colour	Price £
SSEB3	046	920	3.0m Standard Eaves Beam	White	383.35
SSEB4	046	920	4.0m Standard Eaves Beam	White	425.34
SSEBC	046	920	Standard Eaves Beam Connector	White	21.05

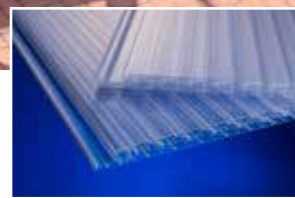

APPLICATIONS

- Carports
 - Pool covers
 - Canopies
 - Veranda covers
 - Patio covers
- Easy to handle
 - Light in weight
 - Simple DIY assembly
 - Very strong
 - Impact resistant
 - UV protected

Corotherm Clickfit

DIY Polycarbonate Roof

Manufactured from damage resistant polycarbonate, **Corotherm Clickfit** is the easy fit DIY roofing system that guarantees long-term performance. Requiring no glazing bars, the easy fit panels simply click and lock together to provide an instant roof.

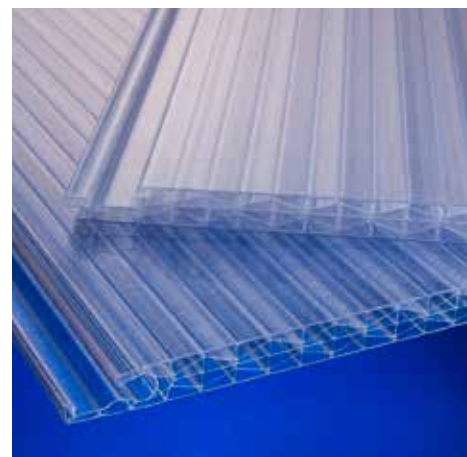

Perfect for DIY use, only standard tools are required to install. Simply cut panels to the required length, screw into place, click and fit the next panel and repeat, then finish with a U profile.

The panels are manufactured from impact resistant polycarbonate which

is hardwearing, durable and long-lasting. This super clear sheet has added UV protection so that you can enjoy the great outdoors whilst being protected from the harmful effects of the sun.

Clickfit DIY Polycarbonate

Code	PG	Disc	Item Description	Tint	Price £
83001	32	500	Corotherm Clickfit Polycarb Sheet 16mm x 3000mm x 500mm	Clear	112.15
83011	32	500	Corotherm Clickfit Polycarb Sheet 16mm x 3000mm x 500mm	Opal	117.75
83031	32	500	Corotherm Clickfit F-Profile Aluminium 16mm x 3m	-	59.03
83041	32	500	Corotherm Clickfit U-Profile Aluminium 16mm x 3m	-	25.10
84001	32	500	Corotherm Clickfit Polycarb Sheet 16mm x 4000mm x 500mm	Clear	149.55
84011	32	500	Corotherm Clickfit Polycarb Sheet 16mm x 4000mm x 500mm	Opal	157.09
84031	32	500	Corotherm Clickfit F-Profile Aluminium 16mm x 4m	-	79.70
84041	32	500	Corotherm Clickfit U-Profile Aluminium 16mm x 4m	-	32.48
83051	32	500	Corotherm Clickfit Channel Washer*	-	0.87
BMNO	45	761	10/16mm Aluminium Sealing Tape 38mm x 10m	-	9.58
BSTP	45	761	10/16mm Breather Tape 38mm x 10m	-	44.51
76590	45	761	Low Modulus Silicone Sealant 310ml White	-	18.77

4m sizes also available POA. * Please use 4mm panhead stainless steel screws and 6mm drill piece, for expansion.

Corotherm Topfit



Polycarbonate Standing Seam

Corotherm Topfit is a versatile modular panel glazing system with extruded standing seam profile. With a range of accessories the system can be adapted to suit a wide range of roofing and façade designs.



APPLICATIONS

- Pitched rooflights
- Curved rooflights
- Canopies
- Vertical façades
- Cladding & partitioning

- High light transmission
- Thermally insulating multiwall panels
- Watertight
- 200 times stronger than glass
- Suitable for cold curving
- Free thermal expansion
- Longlife UV weather protection

Corotherm Topfit 16mm 7wall Polycarbonate Standing Seam Glazing System

Code	PG	Disc	Item Description	Tint	Price £
88100	32	500	Corotherm Topfit Polycarb Sheet 16mm x 6000mm x 1000mm	Clear	538.36
88600	32	500	Corotherm Topfit Polycarb Sheet 16mm x 6000mm x 600mm	Clear	323.02
88051	32	500	Corotherm Topfit PC Cap 6000mm	-	77.94
88061	32	500	Corotherm Topfit Aluminum mullion profile 6000mm	-	169.22
88071	32	500	Corotherm Topfit Standing Seam Clip (each)	Clear	3.22
88031	32	500	Corotherm Topfit F-Profile Aluminium 16mm x 6m	-	165.29
88041	32	500	Corotherm Topfit U-Profile Aluminium 16mm x 3m	-	44.08
88081	32	500	Corotherm Topfit Polycarb Cap	Clear	0.94
BZOP	45	761	Aluminium Sealing Tape 25mm x 10m	-	11.29
BVTP	45	761	Breather Tape 25mm x 10m	-	52.07
76590	45	761	Low Modulus Silicone Sealant 310ml White	-	18.77

Corolite

Corrugated Polycarbonate

Engineered to last, mega tough **Corolite** polycarbonate sheets combine strength and impact resistance with glass-like clarity and light transmission. This hardwearing and durable rooflight material is ideal for roofing applications which demand a sheet that punches above its weight for guaranteed long-term performance.



- High light transmission
- High optical clarity
- Impact resistant
- Lightweight
- UV protected
- Excellent fire performance
- Resistant to chemicals
- 10 year limited guarantee*



APPLICATIONS

- Patio Canopies
- Awnings
- Greenhouses
- Carports
- Gazebos & Pergolas



*When fitted to manufacturers instructions

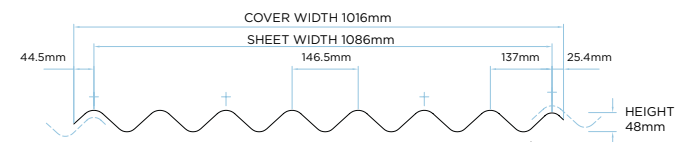

Corolite 6" ASB

Code	PG	Disc	Product Description	Colour	Width mm	Thickness mm	Length mm	Price £
76995	067	067	Corrugated Polycarbonate Sheet	Clear	1086	1.3	3050	137.41
76999	067	067	Corrugated Polycarbonate Sheet	Clear	1086	1.0	3050	105.72

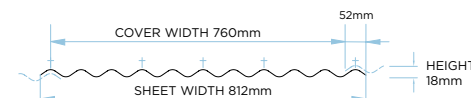

Corolite Iron Profile 10/3"

Code	PG	Disc	Product Description	Colour	Width mm	Thickness mm	Length mm	Price £
27004	067	067	Corrugated Polycarbonate Sheet	Clear	812	1.0	1830	48.13
27008	067	067	Corrugated Polycarbonate Sheet	Clear	812	1.0	2440	64.20
27012	067	067	Corrugated Polycarbonate Sheet	Clear	812	1.0	3050	80.28

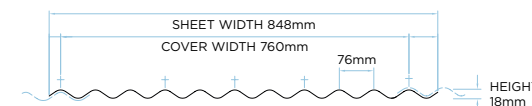

Corolite Iron Profile 10.5/3"

Code	PG	Disc	Product Description	Colour	Width mm	Thickness mm	Length mm	Price £
76902	067	067	Corrugated 3" Polycarbonate Sheet	Clear	848	0.8	1800	55.40
76904	067	067	Corrugated 3" Polycarbonate Sheet	Clear	848	0.8	2400	73.88
76906	067	067	Corrugated 3" Polycarbonate Sheet	Clear	848	0.8	3000	92.34

Corolite Diamond

Embossed Corrugated Polycarbonate Sheet



Corolite Diamond is a super tough corrugated polycarbonate sheet with an attractive diamond embossed pattern. At 2.8mm in thickness, the sheets are stronger and more rigid, providing superior spanning and load bearing capabilities. Naturally clear, these sheets provide exceptional glass like light transmission.



APPLICATIONS

- Rooflights & Canopies
- Vertical Glazing & Screens
- Decorative Display
- Carports
- Gazebos



- Superior impact resistance
- Exceptional hail resistance
- Hardwearing and resilient
- Light in weight
- High levels of light transmission
- Excellent fire performance
- Co-extruded UV protection
- Distinctive diamond cut surface

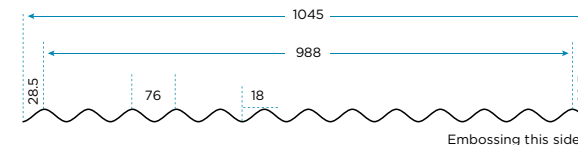

Corolite Diamond

Code	PG	Disc	Product Description	Colour	Width mm	Thickness mm	Length mm	Price £
28004	067	067	Corrugated Polycarbonate Sheet	Clear	1045	2.8	1830	151.51
28008	067	067	Corrugated Polycarbonate Sheet	Clear	1045	2.8	2440	202.01
28012	067	067	Corrugated Polycarbonate Sheet	Clear	1045	2.8	3050	252.50

Corolite CST

Corrugated Multiwall Polycarbonate

Corolite CST corrugated multiwall polycarbonate sheet provides all the durability and impact resistance of Corolite corrugated polycarbonate sheet with the added insulation and rigidity provided by the multiwall structure. It can be used along with other roofing materials such as fibre cement sheeting or as a complete roof covering or wall cladding material.

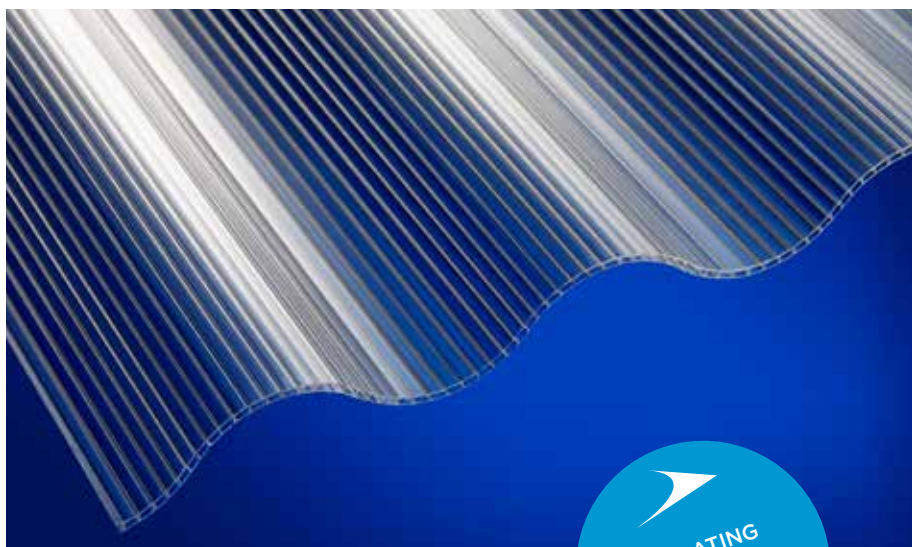

- Lightweight
- Reduced risk of condensation
- UV protected
- Excellent fire performance
- Resistant to chemicals
- 10 year limited guarantee*



*When fitted to manufacturers instructions



APPLICATIONS

- Rooflights
- Greenhouses
- Vertical glazing
- Canopies
- Cladding
- Screens

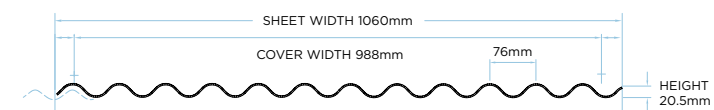

Corolite CST Iron Profile 13/3" Twinwall

Code	PG	Disc	Product Description	Colour	Width mm	Thickness mm	Length mm	Price £
75004	067	067	Corrugated Twinwall Sheet	Clear	1060	2.5	1830	86.28
75008	067	067	Corrugated Twinwall Sheet	Clear	1060	2.5	2440	115.01
75012	067	067	Corrugated Twinwall Sheet	Clear	1060	2.5	3050	143.79

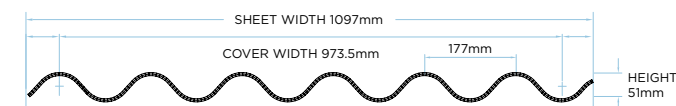

Corolite CST 177/51 Triplewall

Code	PG	Disc	Product Description	Colour	Width mm	Thickness mm	Length mm	Price £
76004	067	067	Corrugated Triplewall Sheet	Clear	1097	6	1830	139.80
76008	067	067	Corrugated Triplewall Sheet	Clear	1097	6	2440	186.51
76012	067	067	Corrugated Triplewall Sheet	Clear	1097	6	3050	233.09

Vistalux

Corrugated PVC

UV RESISTANT
10 YEAR
GUARANTEE



Watch Video Guide

View Installation Guide



Economic, lightweight and easy to install, **Vistalux** is a versatile corrugated rooflight sheet for car ports, canopies and gazebos. It is easy to cut, drill and install with standard DIY tools and is available in a choice of corrugated profiles in clear or translucent tint options.

- Clear or translucent
- Range of profiles
- Sheet weights: Lightweight 0.8mm, Heavy Duty 1.1mm, Superweight 1.3mm
- UV resistant for durability
- Largely self-cleaning
- 10 year guarantee

STORAGE ADVICE

Do not store sheets in direct sunlight as this can cause distortion.

APPLICATIONS

- Carports
- Covered Walkways
- Porches
- Splash Barriers
- Cloches & Cold Frames
- Planhouses
- Side Cladding

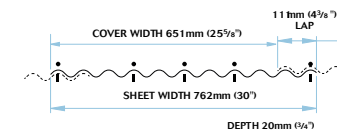

Vistalux ASB 3''
(matches Asbestos profile)

Code	PG	Disc	Product Description	Thickness mm	Colour	Width mm	Length mm/ft	Price £
18004	056	180	Lightweight Sheet	0.8	Clear	762	1830/6	28.60
18006	056	180	Lightweight Sheet	0.8	Clear	762	2135/7	33.43
18008	056	180	Lightweight Sheet	0.8	Clear	762	2440/8	38.20
18010	056	180	Lightweight Sheet	0.8	Clear	762	2745/9	43.00
18012	056	180	Lightweight Sheet	0.8	Clear	762	3050/10	47.68
19004	056	190	Heavy Duty Sheet	1.1	Clear	762	1830/6	43.41
19006	056	190	Heavy Duty Sheet	1.1	Clear	762	2135/7	50.58
19008	056	190	Heavy Duty Sheet	1.1	Clear	762	2440/8	57.79
19010	056	190	Heavy Duty Sheet	1.1	Clear	762	2745/9	65.02
19012	056	190	Heavy Duty Sheet	1.1	Clear	762	3050/10	72.22
19016	056	190	Heavy Duty Sheet	1.1	Clear	762	3660/12	86.70
20002	056	200	BS Superweight Sheet	1.3	Clear	762	1525/5	42.95
20004	056	200	BS Superweight Sheet	1.3	Clear	762	1830/6	51.45
20006	056	200	BS Superweight Sheet	1.3	Clear	762	2135/7	60.04
20008	056	200	BS Superweight Sheet	1.3	Clear	762	2440/8	68.64
20010	056	200	BS Superweight Sheet	1.3	Clear	762	2745/9	77.21
20012	056	200	BS Superweight Sheet	1.3	Clear	762	3050/10	85.84
20016	056	200	BS Superweight Sheet	1.3	Clear	762	3660/12	102.95

Vistalux ASB 3'' Accessories

Code	PG	Disc	Product Description	Cover Width mm	Price £
35000	058	350	3'' Super Fixings (Pack of 10)	-	3.77
37001	058	370	3'' Wall Flashings Clear PVC 695mm	-	17.03
39000	058	390	3'' Polyethylene Eaves Filler (Pack of 6) 680mm	-	10.61
ERDP	058	360	3'' Adjustable Ridge Clear PVC - 685mm	574	39.91
38011	058	350	Sealing Strip 15m	-	14.03

*2 pieces required to make 1 metre ridge.

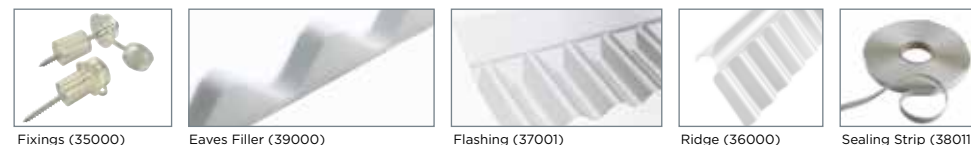

Fixings (35000)

Eaves Filler (39000)

Flashing (37001)

Ridge (36000)

Sealing Strip (38011)

Vistalux ASB 6"
(matches Asbestos profile)

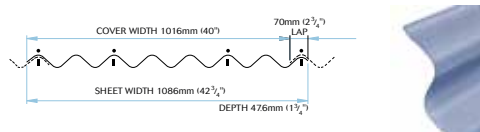

Code	PG	Disc	Product Description	Thickness mm	Colour	Width mm	Length mm/ft	Price £
22002	056	220	BS Superweight Sheet	1.3	Clear	1086	1525/5	64.23
22004	056	220	BS Superweight Sheet	1.3	Clear	1086	1830/6	80.82
22006	056	220	BS Superweight Sheet	1.3	Clear	1086	2135/7	94.55
22008	056	220	BS Superweight Sheet	1.3	Clear	1086	2440/8	107.77
22010	056	220	BS Superweight Sheet	1.3	Clear	1086	2745/9	121.46
22012	056	220	BS Superweight Sheet	1.3	Clear	1086	3050/10	134.73
22016	056	220	BS Superweight Sheet	1.3	Clear	1086	3660/12	161.82

Vistalux ASB 6" Accessories

Code	PG	Disc	Product Description	Price £
35002	058	350	6" Fixings (Pack of 10)	26.64
76853	058	390	6" Polyethylene Eaves Filler (Pack of 6) 950mm	21.59
38011	058	350	Ariel Sealing Strip per 15m	14.03

Vistalux 8/3"
(matches corrugated iron profile)

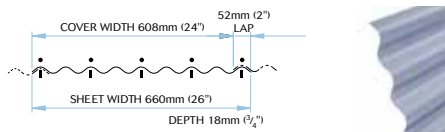

Code	PG	Disc	Product Description	Thickness mm	Colour	Width mm	Length mm/ft	Price £
21004	056	210	Heavy Duty Sheet	1.1	Clear	660	1830/6	43.41
21008	056	210	Heavy Duty Sheet	1.1	Clear	660	2440/8	57.79
21012	056	210	Heavy Duty Sheet	1.1	Clear	660	3050/10	72.22

Vistalux 8/3" Accessories

Code	PG	Disc	Product Description	Price £
35000	058	350	3" Super Fixings (Pack of 10)	3.77
38011	058	350	Sealing Strip 15m	14.03
39010	058	370	C. Iron Wall Flashing PVC (Clear) *710mm	17.00
39003	058	390	C. Iron Eaves Filler (Pack of 6, White) *810mm	17.48

*Nominal measurement.

Corolux Miniature Profile

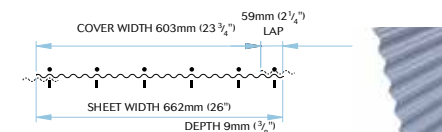

Code	PG	Disc	Product Description	Thickness mm	Colour	Width mm	Length mm/ft	Price £
11004	055	110	Lightweight Sheet	0.8	Translucent	662	1830/6	20.02
11008	055	110	Lightweight Sheet	0.8	Translucent	662	2440/8	26.68
11012	055	110	Lightweight Sheet	0.8	Translucent	662	3050/10	33.41
12004	055	120	Lightweight Sheet	0.8	Clear	662	1830/6	26.68
12008	055	120	Lightweight Sheet	0.8	Clear	662	2440/8	35.65
12012	055	120	Lightweight Sheet	0.8	Clear	662	3050/10	44.50

Corolux Miniature Profile Accessories

Code	PG	Disc	Product Description	Price £
34000	058	340	Miniature Profile Fixings (Pack of 10)	1.08
37002	058	370	Mini Wall Flashings Clear PVC 710mm	16.06
39002	058	390	Miniature Polyethylene Eaves Filler (Pack of 6) 690mm	7.23
38011	058	350	Ariel Sealing Strip per 15m	14.03

View Installation Guide



Visit the Ariel website
for the latest product information
and merchant support
arielplastics.com



Coroline

Corrugated Bituminous Roofing Sheet

Onduline®



Watch Video Guide [View Installation Guide](#)





To install a shed roof, view the Coroline installation video online

Environmentally friendly roofing options, **Coroline** and **Onduline** corrugated bitumen sheets are tough, lightweight roofing materials made from bitumen saturated organic fibres. Coroline is 2.6mm thick, Onduline is 3mm thick and Onduline Mini is 2.6mm thick.

- Economical • Resilient • Simple to fix
- Environmentally friendly
- Guaranteed waterproof for 15 years*
- High insulation & sound absorbency values
- Compatible with most commercially available construction materials

APPLICATIONS

- Garden Sheds
- Garages
- Stables
- Agricultural Buildings



*When fitted to manufacturers instructions

PROPERTIES	COROLINE	ONDULINE MINI	ONDULINE
Sheet Size	2000mm x 950mm	2000mm x 866mm	2000mm x 950mm
Cover Width	855mm	768mm	855mm
Thickness	2.6mm	2.6mm	3mm
Sheet Weight	5.6kg	5.8 kg	6.4kg
Material Weight	2.9kg/m ²	3.4kg/m ²	3.3kg/m ²
Corrugation	38mm height 95mm width	24mm height 48mm width	38mm height 95mm width

Coroline

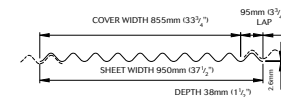

Corrugated Bitumen (Sheet thickness 2.6mm)

Code	PG	Disc	Product Description	Colour	Length mm	Price £
CBS	060	740	Coroline Sheet - 950mm width	Black	2000	24.68
CBR	060	740	Ridge - 1000mm width	Black	-	13.22
74502	060	740	Fixings - Pack of 20	Black	-	3.35
74503	060	740	Fixings - Pack of 400	Black	-	58.72
CGS	060	740	Coroline Sheet - 950mm width	Green	2000	31.99
CGR	060	740	Ridge - 1000mm width	Green	-	14.76
74522	060	740	Fixings - Pack of 20	Green	-	3.35
74523	060	740	Fixings - Pack of 400	Green	-	58.72
CRS	060	740	Coroline Sheet - 950mm width	Red	2000	31.99
CRR	060	740	Ridge - 1000mm width	Red	-	14.76
74512	060	740	Fixings - Pack of 20	Red	-	3.35
74513	060	740	Fixings - Pack of 400	Red	-	58.72
CBRS	060	740	Coroline Sheet - 950mm width	Brown	2000	31.99
CBRR	060	740	Ridge - 1000mm width	Brown	-	14.76
74512	060	740	Fixings - Pack of 20	Brown	-	3.35
74513	060	740	Fixings - Pack of 400	Brown	-	58.72
CGYR	060	740	Coroline Anthracite Grey Ridge - 1m width	Grey	-	27.25
74575	060	740	Coroline Eaves Fillers - 840mm width Pack of 6	-	-	24.12
74200	060	740	PVC Sheet - 950mm width (1.2mm thick)	Translucent	2000	46.05
74202	060	740	PVC Sheet - 950mm width (1.2mm thick)	Clear	2000	35.34

Coroline Ridges, Eaves Fillers and Translucent sheet can be used with Onduline - Coroline discounts will apply. Ridge cover = 875mm

Onduline®

Corrugated Bitumen (Sheet thickness 3mm)

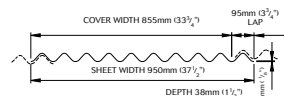

Code	PG	Disc	Product Description	Colour	Length mm	Price £
OBS	061	570	Onduline Sheet - 950mm width	Black	2000	27.79
OVB	061	570	Verge	Black	1000	16.24
OBF2	061	570	Fixings - Pack of 20	Black	-	2.88
OBF4	061	570	Fixings - Pack of 400	Black	-	48.75
OGYS	061	570	Onduline Sheet - 950mm width	Grey	2000	37.03
OVGY	061	570	Verge	Grey	1000	20.16
OGYF2	061	570	Fixings - Pack of 20	Grey	-	2.88
OGYF1	061	570	Fixings - Pack of 100	Grey	-	14.12
OGS	061	570	Onduline Sheet - 950mm width	Green	2000	37.03
OVG	061	570	Verge	Green	1000	20.16
OGF2	061	570	Fixings - Pack of 20	Green	-	2.88
OGF4	061	570	Fixings - Pack of 400	Green	-	48.75
ORS	061	570	Onduline Sheet - 950mm width	Red	2000	37.03
OVR	061	570	Verge	Red	1000	20.16
ORF2	061	570	Fixings - Pack of 20	Red	-	2.88
ORF4	061	570	Fixings - Pack of 400	Red	-	48.75
OBRS	061	570	Onduline Sheet - 950mm width	Brown	2000	37.03
OVBR	061	570	Verge	Brown	1000	20.16
OBRF2	061	570	Fixings - Pack of 20	Brown	-	2.88
OBRF4	061	570	Fixings - Pack of 400	Brown	-	48.75

Onduline Verges can be used with Coroline - Onduline discounts will apply.

Corrugated Bitumen Mini Profile (Sheet thickness 2.6mm)

Code	PG	Disc	Product Description	Colour	Length mm	Price £
CM18B	060	740	Onduline Mini Sheet - 866mm width	Black	2000	31.38
CM18G	060	740	Onduline Mini Sheet - 866mm width	Green	2000	43.54
CMBF2	060	740	Onduline Mini Fixings - pack 20	Black	-	3.09

Corrugated Bitumen Accessories

Code	PG	Disc	Product Description	Colour	Width mm	Price £
OBA	061	570	Apron Flashing	Black	930	35.56
FT150	077	780	Ondutle Eaves Tray	-	1500	6.58
OBG	061	570	Batten Cloaking Piece	-	1220	13.00
OVS	061	570	Ventilator Strip	-	1010	12.44

• Verge cover = 875mm • Apron Flashing cover = 846mm • Eaves Tray cover = 1350mm
• Batten Cloaking Piece Cover = 1120mm

Onduline®

Duro SX35

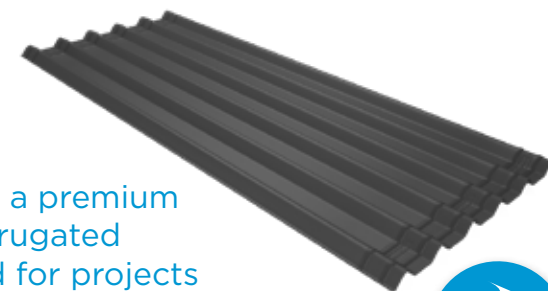

Onduline Duro SX35 is a premium quality bituminous corrugated roofing sheet designed for projects where a longer-lasting and modern looking roof covering is required.

The traditional boxed profiled sheets are available in the popular anthracite grey colour to match a range of other building accessories such as windows and doors.

APPLICATIONS

- Carports
- Garden sheds
- Garages
- Outbuildings

- Traditional boxed profiled sheets
- Anthracite grey colour
- Ideal for projects where a long-lasting roof covering is required
- Tough and resilient
- Highly insulating and sound absorbing
- Easy to carry, handle and install
- Waterproof for up to 20 years
- Compliant with EN 534 category S

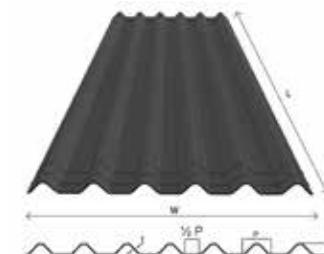

Onduline Duro SX 35 Anthracite Grey (Sheet thickness 3.5mm)

Code	PG	Disc	Product Description	Price £
DUAGS	061	570	Onduline Duro Anthracite Sheet (2m)	42.42
DUAGR	061	570	Onduline Duro Anthracite Grey Ridge	36.33
DUAGSV	061	570	Onduline Duro Anthracite Grey Slim Verge (1m)	21.32
DUAGV	061	570	Onduline Duro Anthracite Grey Verge (1m)	21.32
DUAGF1	061	570	Onduline Duro Anthracite Grey Fixings (Pk100)	29.93



Watch Video Guide



View Installation Guide



AVAILABLE IN A RANGE OF COLOURS
10 YEAR GUARANTEE

Bardoline Classic Roofing Shingles are manufactured from high quality materials, using the latest production technology to produce an attractive, durable and weatherable roof finish.

- Durable and hardwearing
- Environmentally friendly
- Guaranteed waterproof for 10 years
- Choice of colours
- Easy fix using DIY tools

APPLICATIONS

- Playhouses
- Tool Sheds
- Kennels
- Garden Rooms
- Summer Houses
- Garages

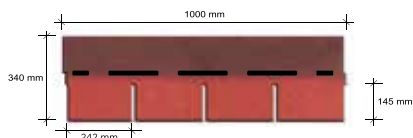

Coroshingle Roofing Shingles

Code	PG	Disc	Product Description	Colour	Width mm	Length mm	Price £
CGSH2	068	642	Coroshingle Shingles (2m ² per pack)	Green	340	1000	64.65
CGDS225	068	642	Coroshingle Detail Strip Roll	Green	300	7500	52.08
CRSH2	068	642	Coroshingle Shingles (2m ² per pack)	Red	340	1000	64.65
CRDS225	068	642	Coroshingle Detail Strip Roll	Red	300	7500	52.08
CSSH2	068	642	Coroshingle Shingles (2m ² per pack)	Grey	340	1000	64.65
CSDS225	068	642	Coroshingle Detail Strip Roll	Grey	300	7500	52.08



CUT TO SIZE SERVICE



Leave the cutting to the experts

- Cut to Size Service for
 - Polycarbonate
 - Acrylic
 - Styrene
- 48-hour service*
- **See Page 70**

*Terms & conditions apply



Corotile

Lightweight Metal Roofing System

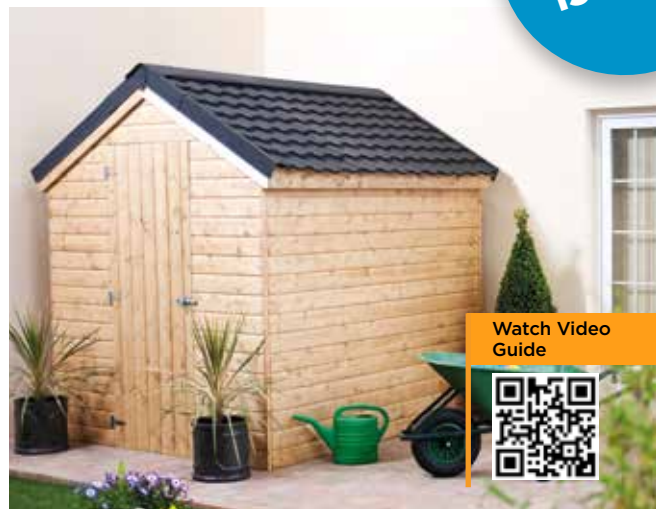

APPLICATIONS

- Chalets
- Playhouses
- Tool sheds
- Garden offices
- Stables
- Garages

Corotile is an innovative lightweight metal roofing system which is easy to fit on any size of roof. Its distinct profile and charcoal finish can enhance a wide variety of small building projects, from tool sheds to garden offices.

The cover length for Corotile is 925mm and the cover width is 635mm; these are the minimum overlaps.

- Easy to install
- Strong & secure
- Lasts 20+ years
- 15 year guarantee

Metal Roofing System

Code	PG	Disc	Product Description	Colour	Width mm	Price £
CTPANEL	069	944	Corotile Panel - 1140mm length	Charcoal Grey	860mm	66.41
CTBARGE	069	944	Corotile Barge Board - 900mm length	Charcoal Grey	140mm	47.04
CTRIDGE	069	944	Corotile Ridge - 905mm length	Charcoal Grey	340mm	41.22
CTCAP	069	944	Corotile End Cap	Charcoal Grey	-	20.87
CTFIX	069	944	Corotile Screws & Washers (10pk)	Charcoal Grey	-	4.41

Corozinc

Galvanised Corrugated Sheet

Suitable for roofing and cladding, Ariel's galvanised corrugated roofing sheet is available in the 8/3 profile in various lengths. Cover width is 610mm.

- Extremely hardwearing
- Zinc coated on both sides
- Choice of lengths available
- Easy fix using DIY tools



APPLICATIONS

- Outhouses
- Tool Sheds
- Kennels
- Garages

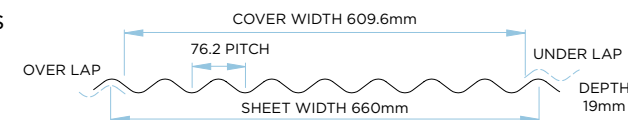

Corozinc Galvanised Sheet

Code	PG	Disc	Product Description	Width mm	Length mm	Price £
55002	073	025	Galvanised Corrugated 8/3 Roof Sheet	660	1525	45.12
55004	073	025	Galvanised Corrugated 8/3 Roof Sheet	660	1830	54.12
55006	073	025	Galvanised Corrugated 8/3 Roof Sheet	660	2135	63.16
55008	073	025	Galvanised Corrugated 8/3 Roof Sheet	660	2440	72.16
55010	073	025	Galvanised Corrugated 8/3 Roof Sheet	660	2745	81.19
55012	073	025	Galvanised Corrugated 8/3 Roof Sheet	660	3050	90.20
55016	073	025	Galvanised Corrugated 8/3 Roof Sheet	660	3660	108.24

Corozinc Galvanised Sheet Accessories

Code	PG	Disc	Product Description	Width mm	Length mm	Price £
55052	073	025	Galvanised Corrugated 8/3 Angle 105°	200	2500	76.49
55054	073	025	Galvanised Corrugated 8/3 Barge 90°	200	2500	76.49
55056	073	025	Galvanised Corrugated 8/3 Ridge 145°	200	2500	76.49
55058	073	025	Galvanised Corrugated 8/3 Fixings (100pk)	-	60	29.00



NOTE

It is advisable when fitting roof sheets to ensure that they are overlapping by at least one corrugation and to work from left to right on a building when installing. This product range should be handled with care and can only be offloaded with a forklift truck.

Flat Glazing

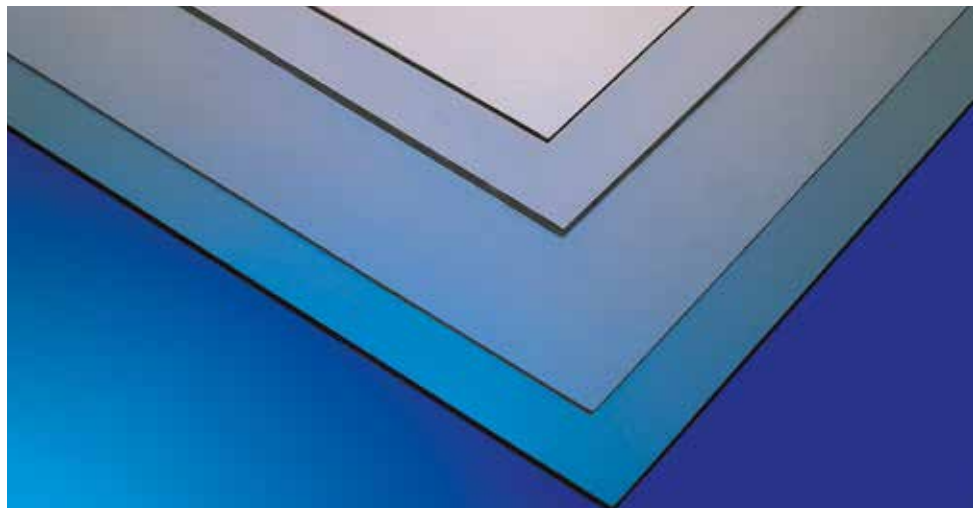

Ariel Plastics offer an extensive range of **flat glazing** options in clear acrylic sheet and polystyrene sheet for a range of applications. Acrylic sheet offers UV protection.

- Flexible
- Light in weight
- Range of sizes

PROPERTIES	LITEGLAZE	STYRENE
Impact Resistance	Good 7 times that of glass	Good 5 times that of glass
Suitable for exterior use	Yes	No
Optical Clarity	Good	Good
Light Transmission	92%	92%
Material Weight	2.38kg/m ²	2.1kg/m ²

Acrylic Sheet Exterior
Polystyrene Sheet Interior Grade

Ariel is here to help and assist with any requirements to find the right material to keep people safe.



We will help find a product solution for any application

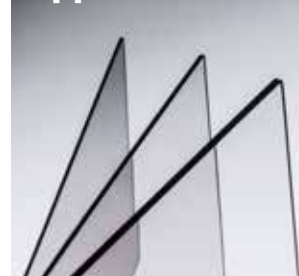

We have a wide range of suitable products in a variety of sizes and thicknesses which can be used to create protective screens and partitions which will have an important role to play in providing a physical barrier to help maintain social distance and keep people safe.

Ariel products are ideal as they can all be easily cut, drilled and bent to suit the available space for quick installation. They are portable and come in transparent and translucent options which are easy to clean.



Applications

Protective Screens & Partitions

Uses: Retail, Manufacturing, Distribution, Public Spaces, Reception Desks, Open Plan Offices, Canteens etc.



View Installation Guide



INTERIOR & EXTERIOR USE

APPLICATIONS

- Secondary Double Glazing
- Replacement Windows (Planhouses & Sheds)
- Cloches & Coldframes
- Room Dividers
- Display Cases & Door Panels

FEATURES

- Safer & stronger than glass
- Easily transportable
- Light in weight
- UV resistant
- Flexible
- Suitable for interior & exterior use

Acrylic Sheet Range

UV Protected both sides. Suitable for interior and exterior use.

Code	PG	Disc	Product Description	Thickness mm	Width mm	Length mm	Price £
66000	064	660	Acrylic Sheet	2	600	1200	47.38
66002	064	660	Acrylic Sheet	2	600	1800	71.10
66001	064	660	Acrylic Sheet	2	1200	1200	94.76
66003	064	660	Acrylic Sheet	2	1200	1800	142.17
66004	064	660	Acrylic Sheet	2	1200	2400	189.56
66025	064	660	Acrylic Sheet	4	600	1200	94.76
66032	064	660	Acrylic Sheet	4	600	1800	142.95
66021	064	660	Acrylic Sheet	4	1200	1200	189.56
66019	064	660	Acrylic Sheet	4	1200	1800	284.27
66031	064	660	Acrylic Sheet	4	1200	2400	379.06
66040	064	660	Acrylic Sheet	6	600	1200	123.03
66043	064	660	Acrylic Sheet	6	900	1200	184.54
66046	064	660	Acrylic Sheet	6	600	1800	202.99

Acrylic Sheet Accessories

Code	PG	Disc	Product Description	Colour	Depth mm	Length mm	Price £
76711	064	660	Liteglaze Glazing Strip	White	10	1830	12.08



INTERIOR USE ONLY

APPLICATIONS

- Splashbacks & Wallpaper Protection
- Display Cases & Cupboard Fronts
- Room Dividers
- Interior Door Panels
- Lightweight Shelving
- Picture Framing

FEATURES

- Safer & stronger than glass
- Easily transportable
- Light in weight
- Economical
- Suitable for interior use only

Clear Polystyrene Sheet Standard Range - Only suitable for interior use.

Code	PG	Disc	Product Description	Thickness mm	Width mm	Length mm	Price £
64120	065	645	Polystyrene Sheet	2	600	1200	35.77
64122	065	645	Polystyrene Sheet	2	600	1800	53.60
64121	065	645	Polystyrene Sheet	2	900	1200	53.60
64124	065	645	Polystyrene Sheet	2	1200	1200	71.50
64125	065	645	Polystyrene Sheet	2	1200	1800	107.20
64126	065	645	Polystyrene Sheet	2	1200	2400	142.95
64130	065	645	Polystyrene Sheet	4	600	1200	67.29
64133	065	645	Polystyrene Sheet	4	600	1800	100.90
64131	065	645	Polystyrene Sheet	4	900	1200	100.90
64132	065	645	Polystyrene Sheet	4	1200	1200	134.51
64134	065	645	Polystyrene Sheet	4	1200	1800	201.78
64136	065	645	Polystyrene Sheet	4	1200	2400	269.04

Brett Martin Mardome

POLYCARBONATE DOME ROOFLIGHTS RANGE



Designed to bring natural daylight into new build and extension projects, these quality dome rooflights are perfect for low pitched roof projects and will transform open plan living areas, kitchens, bathrooms, hallways and commercial units into modern and bright spaces.

- Thermally efficient single, double, triple glazed options with U values as low as 0.96 W/m²K
- Up to 27% more daylight area than other rooflights
- Impact resistant outer glazing in Marlon FSX Longlife polycarbonate with UV protection
- BBA approved
- 10 year guarantee



Need a rooflight on site quick? Try our 48 hour Hi-Lights service.

A selection of the most popular Mardome polycarbonate rooflights (pages 68-69) are available from stock within 48 hours* of placing an order for delivery direct to site.

* Terms & Conditions apply – see page 4.



Bringing style, quality and adaptability, the Mardome rooflights range from Brett Martin offers options to satisfy the requirements of most projects and budgets.

Mardome Trade



Mardome Trade is supplied with a PVC kerb or to fit a builders upstand. A range of ventilation and opening options are also available.

Mardome Reflex



Mardome Reflex is suitable where glazing only is required for fixing to existing kerb or upstand on refurbishment projects.

Polycarbonate Glazing

- Outer glazing with UV protection
- Impact resistant
- Dome shape as standard with optional pyramid
- Clear, textured or opal tint

Security Fixings

Mardome Trade rooflights have secure fixings with tamper-proof caps for added security.

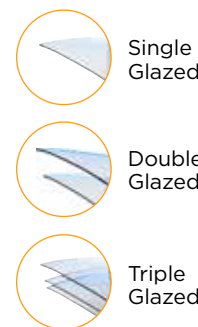

Material	U-value*
Double Skin Polycarbonate	2.7 W/m ² K
Triple Skin Polycarbonate	1.8 W/m ² K

*Centre pane U-value is a measure of the thermal efficiency of the glazing type.

Thermal Efficiency

To meet requirements of Part L of the Building Regulations 2013, Ariel recommends installing triple skin rooflights.

Further information on thermal performance can be found in the technical data sheets.



Mardome Trade



Mardome Reflex

Guidance on Measuring

Mardome with kerb

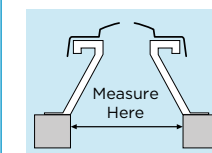

Measure (length x width) of opening

For builders upstand

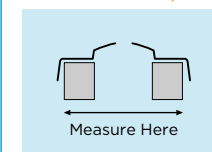

Measure (length x width) of external dimensions of upstand

Mardome Trade

Mardome Trade is supplied with a PVC kerb or to fit a builders upstand. A range of ventilation and opening options mean these dome rooflights can be tailored to suit a variety of project requirements and budget.



The most popular Mardome Trade rooflights are available for 48 hour delivery and have pricing highlighted in orange.

Mardome Trade Range - Non-opening

Size mm	With PVC Kerb			To Fit Builders Upstand					
	Glazing Skin			Unvented			Vented		
	x3	x2	x1	x3	x2	x1	x3	x2	x1
600 x 600	391	301	253	288	198	150	394	304	256
600 x 900	495	382	320	359	246	184	493	380	318
600 x 1200	619	479	398	462	321	241	613	472	392
750 x 750	486	373	311	361	248	186	484	372	310
750 x 900	537	413	346	392	269	201	532	409	342
900 x 900	556	431	362	405	280	211	549	424	356
900 x 1200	799	610	488	629	440	318	790	602	480
1050 x 1050	650	503	421	482	335	253	640	494	411
1200 x 1200	821	627	504	635	441	318	808	614	491
1200 x 1800	1,218	894	659	997	674	438	1,198	875	639
Options									
Manual Vent	39	39	39	-	-	-	Vent included		

Products with prices highlighted are available for 48 hour delivery. See pages 68-69 for product codes.

Mardome Trade



Mardome Trade Range - Opening Options

Additional Extras

Size mm	Manual Opening with PVC Kerb		Manual Opening to Fit Builders Upstand		Powered Opening	Powered Opening with Remote & Rain Sensor	Access Hatch
	Glazing Skin		Glazing Skin				
	x3	x2	x3	x2			
600 x 600	567	476	530	440	172	616	-
600 x 900	711	599	670	558	205	648	-
600 x 1200	1,005	864	960	819	203	647	-
750 x 750	685	572	645	532	186	630	-
750 x 900	756	633	713	590	205	648	87
900 x 900	779	653	734	608	205	648	87
900 x 1200	1,040	851	993	804	206	649	88
1050 x 1050	883	737	835	689	203	647	85
1200 x 1200	1,081	888	1,028	834	205	648	87
1200 x 1800	1,693	1,370	1,635	1,312	461	904	-

Products with prices highlighted are available for 48 hour delivery. See pages 68-69 for product codes.

ROOFLIGHT ACCESSORIES

Security Grille

Range of sizes available POA.



Opening Poles

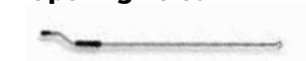

Code	Description	Price £
M100	2m Opening Pole	35
M101	3m Opening Pole	47

Mardome Trade



POLYCARBONATE DOME ROOFLIGHT RANGE

Double Glazed with PVC kerb providing 150mm waterproofing termination height



		Rooflight Size = finished roof opening size					
		600 x 600mm	600 x 900mm	750 x 750mm	900 x 900mm	1050 x 1050mm	1200 x 1200mm
Double Glazed with PVC Kerb	Code	M001	M002	M003	M004	M005	M006
	Price £	301	382	373	431	503	627
Double Glazed Opening with PVC Kerb	Code	M007	M008	M009	M010	M011	M012
	Price £	476	599	572	653	737	888

Part L Compliant Triple Glazed with PVC kerb providing 150mm waterproofing termination height

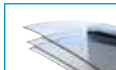

		Rooflight Size = finished roof opening size					
		600 x 600mm	600 x 900mm	750 x 750mm	900 x 900mm	1050 x 1050mm	1200 x 1200mm
Triple Glazed Mardome with PVC Kerb	Code	M013	M014	M015	M016	M017	M018
	Price £	391	495	486	556	650	821
Triple Glazed Opening Mardome with PVC Kerb	Code	M019	M020	M021	M022	M023	M024
	Price £	567	711	685	779	883	1081

Mardome Trade



POLYCARBONATE DOME ROOFLIGHT RANGE

Direct Fix without Kerb & unvented

		Rooflight Size = external upstand distance					
		600 x 600mm	600 x 900mm	750 x 750mm	900 x 900mm	1050 x 1050mm	1200 x 1200mm
Direct Fix Single Glazed	Code	M025	M026	M027	M028	M029	M030
	Price £	150	184	186	211	253	318
Direct Fix Double Glazed	Code	M031	M032	M033	M034	M035	M036
	Price £	198	246	248	280	335	441
Direct Fix Triple Glazed	Code	M037	M038	M039	M040	M041	M042
	Price £	288	359	361	405	482	635

Reflex Range



Mardome Reflex

Mardome Reflex is a glazing only unit designed specifically for refurbishment projects where the glazing only needs to be replaced and can be easily fixed to existing kerbs or upstands. The unit is supplied with a fixing kit including weathertight washers and cover plugs.

Products highlighted in orange are available for 48 hour delivery.

Size mm	Glazing Skin		
	x3	x2	x1
450 x 450	262	198	150
600 x 600	262	198	150
600 x 900	329	246	184
600 x 1200	436	321	241
750 x 750	329	248	186
750 x 900	357	269	201
900 x 900	366	280	211
900 x 1200	600	440	318
1050 x 1050	440	335	253
1200 x 1200	602	441	318
1200 x 1800	959	674	438
1200 x 2400	1,385	954	571
1350 x 1350	814	600	421

Leave the cutting to our trained experts

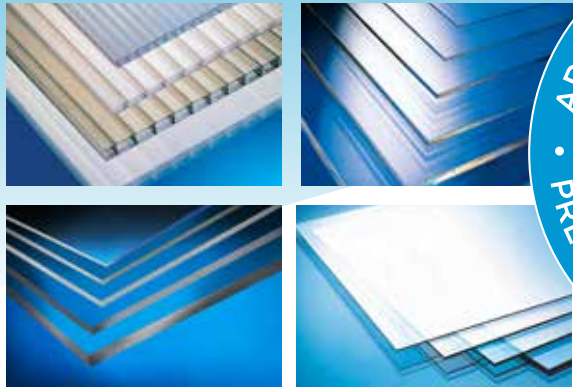

Ariel provides a quick and easy **Cut to Size Service** for Polycarbonate, Acrylic and Styrene sheet delivered within 48 hours nationwide.

Terms & Conditions

Delivery 48hr -
Cut off time on day of order 3pm.
Delivery charges.
1: Yard (invoice address) Free.
2: Site £30.00.
Mainland GB only -
excluding Postcode areas
beginning KW,IV,AB & PH.

Cut To Size Sheet is a bespoke product and non returnable



A full range of Styrene Sheet is available on request



Download order form

Acrylic Sheet



With a superior gloss finish and scratch resistance, Acrylic is a preferred material for projects which require its high end appeal and durability. It can also be flame polished for a clear, shiny edge finish which replicates glass. Excellent weatherability means Acrylic is an excellent glazing material whilst ease of workability makes it suitable for fabrication.

At a glance:

High gloss surface
Optically clear sheet
Half the weight of glass
Scratch resistant
Weatherable

Use for:

POS Displays
Poster Covers
Picture Framing
Splashbacks
Glazing



Cut to Size Prices

Code	PG	Disc	Product Description	Thickness mm	Colour	Sqm Price £	Max. Dimensions mm
A2C	043	403	Solid Acrylic Sheet	2	Clear	25.47	3050 x 2050
A3C	043	403	Solid Acrylic Sheet	3	Clear	38.21	3050 x 2050
A4C	043	403	Solid Acrylic Sheet	4	Clear	50.95	3050 x 2050
A5C	043	403	Solid Acrylic Sheet	5	Clear	63.68	3050 x 2050
A6C	043	403	Solid Acrylic Sheet	6	Clear	76.40	3050 x 2050

Full Sheet Prices

Code	PG	Disc	Product Description	Thickness mm	Colour	Price £	Sheet Size mm
79800	043	407	Solid Acrylic Sheet	2	Clear	159.25	3050 x 2050
79801	043	407	Solid Acrylic Sheet	3	Clear	238.86	3050 x 2050
79802	043	407	Solid Acrylic Sheet	4	Clear	318.50	3050 x 2050
79803	043	407	Solid Acrylic Sheet	5	Clear	398.13	3050 x 2050
79804	043	407	Solid Acrylic Sheet	6	Clear	477.74	3050 x 2050

Multiwall Polycarbonate

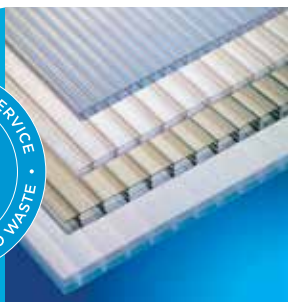

Multiwall polycarbonate is a lightweight, impact resistant glazing and roofing sheet that is very easy to handle and install. It has a protective UV layer which safeguards against the effects of weathering for a longer lasting sheet. A full range of installation accessories are also available.

At a glance:

- A range of thicknesses and tints
- Strong and durable
- Impact resistant
- UV protected
- Class 1 fire rating

Use for:

- Lean-to
- Patio Covers
- Carports
- Greenhouses
- Cold Frames



Cut to Size Prices

Code	PG	Disc	Product Description	Thickness mm	Colour	Sqm Price £	Max. Dimensions mm
BMR10C	050	952	Multiwall Polycarbonate	10	Clear	43.21	4000 x 2100
BMR10B	050	952	Multiwall Polycarbonate	10	Bronze	43.21	4000 x 2100
BMR10O	050	952	Multiwall Polycarbonate	10	Opal	43.21	4000 x 2100
BMR16C	050	953	Multiwall Polycarbonate	16	Clear	68.74	4000 x 2100
BMR16B	050	953	Multiwall Polycarbonate	16	Bronze	68.74	4000 x 2100
BMR16O	050	953	Multiwall Polycarbonate	16	Opal	68.74	4000 x 2100
BMR25C	050	954	Multiwall Polycarbonate	25	Clear	86.42	4000 x 2100
BMR25B	050	954	Multiwall Polycarbonate	25	Bronze	86.42	4000 x 2100
BMR25O	050	954	Multiwall Polycarbonate	25	Opal	86.42	4000 x 2100
BMR25BO	050	954	Multiwall Polycarbonate	25	Bronze Opal	99.56	4000 x 2100
BMR25HO	050	954	Multiwall Polycarbonate	25	Heatguard Opal	99.56	4000 x 2100
BMR35C7	050	955	Multiwall Polycarbonate	35	Clear	99.22	4000 x 2100
BMR35B7	050	955	Multiwall Polycarbonate	35	Bronze	99.22	4000 x 2100
BMR35O7	050	955	Multiwall Polycarbonate	35	Opal	99.22	4000 x 2100
BMR35BO7	050	955	Multiwall Polycarbonate	35	Bronze Opal	114.22	4000 x 2100
BMR35HO7	050	955	Multiwall Polycarbonate	35	Heatguard Opal	114.22	4000 x 2100



Self Supporting Roof (suitable for 16, 25 & 35mm sheet)

Code	PG	Disc	Product Description	Colour	Price £
BMSSGP2	050	951	Self supporting goal posts (2)	White	480.35
BMSSBI25	050	951	2.5m Intermediate bar	White	216.01
BMSSBI30	050	951	3.0m Intermediate bar	White	259.07
BMSSBI35	050	951	3.5m Intermediate bar	White	301.45
BMSSBI40	050	951	4.0m Intermediate bar	White	345.45
BMSSBE25	050	951	2.5m End bar	White	215.95
BMSSBE30	050	951	3.0m End bar	White	259.07
BMSSBE35	050	951	3.5m End bar	White	302.31
BMSSBE40	050	951	4.0m End bar	White	345.45
BMSSEC	050	951	Bar end caps	White	26.69
BMSSBW30	050	951	3.0m Wall plate	White	400.20
BMSSBW40	050	951	4.0m Wall plate	White	533.59
BMSSBW50	050	951	5.0m Wall plate	White	667.01
BMSSEB3	050	951	3.0m standard eaves beam	White	383.35
BMSSEB4	050	951	4.0m standard eaves beam	White	425.34
BMSSEBC	050	951	Eaves beam connector	White	21.05

Polycarbonate Accessories (suitable for 10, 16 & 25mm sheet)

Code	PG	Disc	Product Description	Colour	Length mm	Unit Price £
BMBHPO	050	950	Glazing bar cap and base with end cap	White	3000	102.66
BMBHPR	050	950	Glazing bar cap and base with end cap	White	4000	135.91
BMBHOR	050	950	Glazing bar cap and base with end cap	White	6000	202.73
BMBJOP	050	950	Glazing bar cap and base with end cap	Brown	3000	106.60
BMBYTO	050	950	Glazing bar cap and base with end cap	Brown	4000	141.33
BMBGTY	050	950	Glazing bar cap and base with end cap	Brown	6000	210.21

Tapes

Code	PG	Disc	Product Description	Price £
BM76585	050	950	Flashing tape 225mm x 10m Grey	102.84
BMBT16/10	050	950	10/16mm Breather tape 38mm x 10m	44.51
BMBT25/10	050	950	Breather tape 45mm x 10m	52.07

Side Flashing

Code	PG	Disc	Product Description	Width	Colour	Length mm	Price £
BM76112	050	950	10mm Side Flashing	10mm	White	3000	25.31
BM76113	050	950	10mm Side Flashing	10mm	White	4000	33.72
BM76346	050	950	10mm Side Flashing	10mm	White	6000	50.60
BM76342	050	950	10mm Side Flashing	10mm	Brown	3000	31.68
BM76343	050	950	10mm Side Flashing	10mm	Brown	4000	42.12
BM76466	050	950	10mm Side Flashing	10mm	Brown	6000	63.25
BM76114	050	950	16mm Side Flashing	16mm	White	3000	25.31
BM76115	050	950	16mm Side Flashing	16mm	White	4000	33.72
BM76341	050	950	16mm Side Flashing	16mm	White	6000	50.60
BM76463	050	950	16mm Side Flashing	16mm	Brown	3000	31.68
BM76464	050	950	16mm Side Flashing	16mm	Brown	4000	42.12
BM76465	050	950	16mm Side Flashing	16mm	Brown	6000	63.25
BMBCOS	050	950	25mm Side Flashing	25mm	White	3000	38.71
BMBMOJ	050	950	25mm Side Flashing	25mm	White	4000	51.34
BMBGVV	050	950	25mm Side Flashing	25mm	White	6000	76.63
BMBYKZ	050	950	25mm Side Flashing	25mm	Brown	3000	42.12
BMBHSS	050	950	25mm Side Flashing	25mm	Brown	4000	56.26
BMBPWP	050	950	25mm Side Flashing	25mm	Brown	6000	84.09

End Closures

Code	PG	Disc	Product Description	Length mm	Price £ per linear metre
BMSEC10W	050	950	10mm end closure white	2100	5.73
BMSEC10B	050	950	10mm end closure brown	2100	7.27
BMS16W	050	950	16mm end closure white	2100	5.73
BMS16B	050	950	16mm end closure brown	2100	7.27
BMB25W	050	950	25mm end closure white	3500	8.06
BMB25B	050	950	25mm end closure brown	3500	8.86
BMB35W	050	950	35mm end closure white	3500	11.29
BMB35B	050	950	35mm end closure brown	3500	12.44

Fixing Buttons

Code	PG	Disc	Product Description	Price £
BM76567	050	950	10mm super fixing buttons white (Pk of 10)	28.21
BM76569	050	950	10mm super fixing buttons brown (Pk of 10)	28.21
BM76568	050	950	16mm super fixing buttons white (Pk of 10)	28.21
BM76570	050	950	16mm super fixing buttons brown (Pk of 10)	28.21
BMBVUT	050	950	25mm super fixing buttons white (Pk of 10)	29.22
BMBHUP	050	950	25mm super fixing buttons brown (Pk of 10)	29.22

Flat Polycarbonate

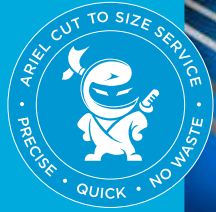

Polycarbonate is the perfect substitute for glass. It is lightweight yet at 200 times stronger than glass it is an exceptionally strong, impact resistant glazing material. With a double-sided UV protection to both sides of the sheet it is the ideal material for exterior glazing. The protective UV layer provides a longer sheet life expectancy, prevents yellowing and guards against loss of strength.

At a glance:

- Impact resistant
- Lightweight
- UV resistant
- Class 1 fire rating

Use for:

- Canopies
- Patio Covers
- Walkways
- Greenhouses
- Glazing



Cut to Size Prices

Code	PG	Disc	Product Description	Thickness mm	Colour	Sqm Price £	Max. Dimensions mm
F2C	043	401	Solid Polycarbonate	2	Clear	35.36	3050 x 2050
F3C	043	401	Solid Polycarbonate	3	Clear	53.04	3050 x 2050
F4C	043	401	Solid Polycarbonate	4	Clear	70.72	3050 x 2050
F5C	043	401	Solid Polycarbonate	5	Clear	88.39	3050 x 2050
F6C	043	401	Solid Polycarbonate	6	Clear	106.09	3050 x 2050
F8C	043	401	Solid Polycarbonate	8	Clear	141.47	3050 x 2050
F10C	043	401	Solid Polycarbonate	10	Clear	176.82	3050 x 2050
F12C	043	401	Solid Polycarbonate	12	Clear	212.18	3050 x 2050
F3O	043	401	Solid Polycarbonate	3	Opal	55.79	3050 x 2050
F5O	043	401	Solid Polycarbonate	5	Opal	93.00	3050 x 2050

Full Sheet Prices

Code	PG	Disc	Product Description	Thickness mm	Colour	Price £	Sheet Size mm
79500	043	405	Solid Polycarbonate	2	Clear	221.08	3050 x 2050
79501	043	405	Solid Polycarbonate	3	Clear	331.65	3050 x 2050
79502	043	405	Solid Polycarbonate	4	Clear	442.20	3050 x 2050
79503	043	405	Solid Polycarbonate	5	Clear	552.76	3050 x 2050
79504	043	405	Solid Polycarbonate	6	Clear	663.30	3050 x 2050
79505	043	405	Solid Polycarbonate	8	Clear	884.42	3050 x 2050
79506	043	405	Solid Polycarbonate	10	Clear	1,105.51	3050 x 2050
79507	043	405	Solid Polycarbonate	12	Clear	1,326.62	3050 x 2050
79600	043	405	Solid Polycarbonate	3	Clear	157.91	2440 x 1220
79601	043	405	Solid Polycarbonate	4	Clear	210.53	2440 x 1220
79602	043	405	Solid Polycarbonate	6	Clear	315.82	2440 x 1220
79508	043	405	Solid Polycarbonate	3	Opal	348.85	3050 x 2050
79509	043	405	Solid Polycarbonate	5	Opal	581.42	3050 x 2050

Hygienic Cladding

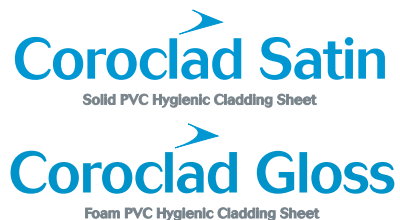

Ariel's hygienic cladding sheets offer an attractive finish to walls and ceilings. The range includes solid PVC sheets in a satin finish and a gloss foam PVC sheet. Both options offer resistance to moisture and chemicals and prohibit microbial materials from being absorbed into the sheets, making them a popular choice for hygienic cladding projects.

Use for:

- Health settings
- Food preparation areas
- Commercial kitchens
- Clean rooms
- Bathrooms
- Changing room facilities
- Agricultural sheds



For full details of the characteristics of both hygienic cladding sheets, please refer to the Cladding brochure.



- Solid PVC in satin white finish
- Non-porous surface prohibits microbial material from absorbing into sheets
- Resistant to moisture and chemicals
- Very tough and durable
- Easy clean, smooth surface

Solid PVC Hygienic Cladding Sheet

Code	PG	Disc	Product Description	Thickness mm	Sheet Size mm	Price £
69000	066	933	Coroclad Satin Solid PVC Hygienic Sheet	1.5	2440 x 1220	124.61
69004	066	933	Coroclad Satin Solid PVC Hygienic Sheet	2.0	2440 x 1220	160.73
69008	066	933	Coroclad Satin Solid PVC Hygienic Sheet	2.5	2440 x 1220	180.79
69012	066	933	Coroclad Satin Solid PVC Hygienic Sheet	2.5	3050 x 1220	195.03
69014	066	933	Coroclad Satin Solid PVC Hygienic Sheet	3.0	2440 x 1220	216.90



- Foam PVC with co-extruded white gloss finish
- Non-porous surface means microbial material cannot absorb into sheets
- Resistant to moisture and chemicals
- Wipe clean surface

Foam PVC Hygienic Cladding Sheet

Code	PG	Disc	Product Description	Thickness mm	Sheet Size mm	Price £
68008	066	933	Coroclad Gloss Foam PVC Hygienic Sheet	3.0	2440 x 1220	162.13

A complete range of white PVC profile accessories are available in two lengths (2.44m and 3m). See page 97.

Economy Clad

Foam PVC General Cladding Sheet

For projects of a lesser specification and where contact from trolleys or loading equipment is unlikely, a general foam PVC cladding sheet is available.

Use for:

- Store rooms
- Offices
- Short term outdoor use

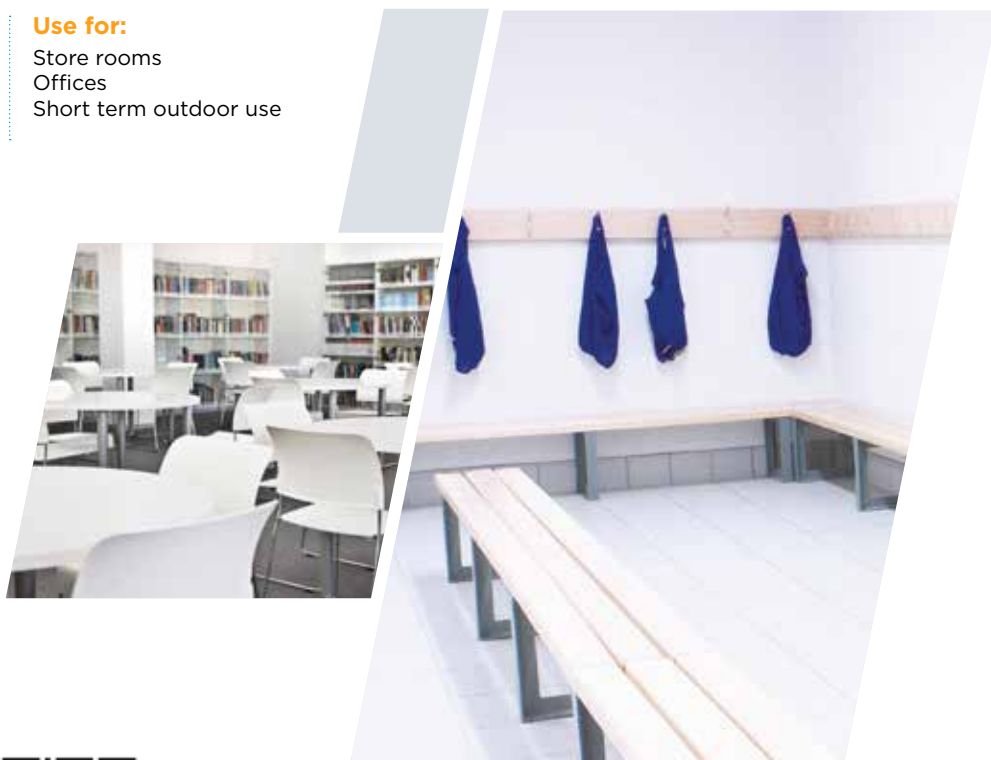

For full details of the characteristics of both hygienic cladding sheets, please refer to the Cladding brochure.

Foam PVC General Cladding Sheet

Code	PG	Disc	Product Description	Thickness mm	Sheet Size mm	Price £
67008	066	933	Economy Clad Solid PVC Cladding Sheet	3.0	2440 x 1220	77.78

PVC Cladding Accessories

Code	PG	Disc	Product Description	Length mm	Price £
76140	066	933	H-Section Division Bar	2440	8.25
76141	066	933	J-Section Starter Trim	2440	6.20
76142	066	933	Internal Corner	2440	4.85
76143	066	933	External Corner	2440	7.95
76144	066	933	H-Section Division Bar Top	2440	4.30
76145	066	933	H-Section Division Bar Base	2440	5.10
76130	066	933	H-Section Division Bar	3000	10.14
76131	066	933	J-Section Starter Trim	3000	7.62
76132	066	933	Internal Corner	3000	5.96
76133	066	933	External Corner	3000	9.78
76134	066	933	H-Section Division Bar Top	3000	5.29
76135	066	933	H-Section Division Bar Base	3000	6.27
76136	066	933	Fix All High Tack 290ml	-	30.08



J Starter Trim



F External corner



C Internal Corner



H Division Bar



H Division Bar Base

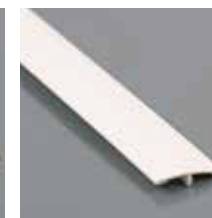

H Division Bar Top

Delivery Schedule (England & Wales)

Order cut-off time Zone	Mon 3.30pm	Tue 3.30pm	Wed 3.30pm	Thur 3.30pm	Fri 3.30pm
A	Fri	Tue	Tue	Thur	Thur
Lead time	4	5	4	5	4
B	Fri	Fri	Tue	Wed	Thur
Lead time	4	3	4	4	4
C	Fri	Tue	Tue	Wed	Thur
Lead time	4	5	4	4	4
D	Tue	Tue	Tue	Thur	Thur
Lead time	5/6	5	4	5	4
E	Fri	Fri	Tue	Thur	Thur
Lead time	4	3	4	5	4
F	Fri	Tue	Tue	Fri	Fri
Lead time	4	5	4	5/6	5
G	Fri	Tue	Tue	Fri	Fri
Lead time	4	5	4	5/6	5
H	Fri	Tue	Tue	Wed	Thur
Lead time	4	5	4	4	4
J	Fri	Tue	Tue	Thur	Thur
Lead time	4	5	4	5	4
K	Fri	Tue	Tue	Fri	Fri
Lead time	4	5	4	5/6	5
L	Fri	Tue	Tue	Fri	Fri
Lead time	4	5	4	5/6	5
M	Fri	Tue	Tue	Wed	Fri
Lead time	4	5	4	4	5
N	Fri	Tue	Tue	Wed	Fri
Lead time	4	5	4	4	5
O	Fri	Fri	Tue	Wed	Thur
Lead time	4	3	4	4	4
P	Fri	Fri	Tue	Thur	Thur
Lead time	4	3	4	5	4

Delivery Schedule (Scotland)

Order cut-off time Zone	Mon 3.30pm	Tue 3.30pm	Wed 3.30pm	Thur 3.30pm	Fri 3.30pm
Borders	Thur	Thur	Tue	Tue	Tue
Lead time	3	2	4	3	3
Central	Fri	Fri	Fri	Wed	Wed
Lead time	4	3	2	4	4
Dumfries	Thur	Thur	Tue	Tue	Tue
Lead time	3	2	4	3	3
Fife	Fri	Fri	Fri	Tue	Tue
Lead time	4	3	2	3	3
Grampian	Thur	Thur	Thur	Thur	Thur
Lead time	6/7	5/6	4/5	4	8
Highland	Wed	Wed	Wed	Wed	Wed
Lead time	6/7	5/6	4/5	4	8
Lothian	Fri	Fri	Fri	Wed	Wed
Lead time	4	3	2	4	4
Strathclyde	Fri	Fri	Fri	Wed	Wed
Lead time	4	3	2	4	4
Tayside	Fri	Fri	Fri	Tue	Tue
Lead time	4	3	2	3	3

Notes

- Refer to GB Postcodes Zone Table for zone location.
- Delivery days shown will, where appropriate, always be the second of any two day run.
- Please utilise this delivery schedule to organise your most beneficial ordering pattern.
- Delivery schedules should be used as a guide, actual delivery day may be rescheduled at short notice due to reasons beyond our control.

Denotes following week

Denotes 8 working day delivery

GB Postcode Delivery Zones

Postcode Prefix	Zone	Postcode Prefix	Zone	Postcode Prefix	Zone
AL1 - 10	O	HP1-27	O	SP1 - 10	M
B1 - 98	C	HR1 - 9	F	SR1 - 8	D
B74,75,77,78,79	B	HU1-20	H	SS0 - 17	P
BA1 - 22	L	HX1-7 B	B	ST1-18	B
BB1 - 18	E	IG1-11	P	ST19-21	F
BD1 - 22	B	IM1-9*	E	SW1,3,5-7,10	M
BD23 - 24	H	IP1-12	P	SW2,4,8,9,11-20	N
BH1 - 25	M	IP13-33	P	SY1 - 25	F
BLO - 9	B	JE1-4*	M	TA1-7,9-24	L
BNI-3,5-7,9-18	N	KT1-24	N	TA8	C
BN 8,20-27	J	L1-70	E	TF1 - 13	F
BN41-45	N	LA1-6,10	E	TN1 - 40	J
BRI-8	J	LA7-9,11-23	K	TQ1 - 14	L
BS1 - 49	C	LD1 - 8	F	TR1 - 27	L
CA1-7,10-15,18-28	K	LE1-7,11-15,16,65,67	B	TS1 - 29	D
CA8,9,16,17	D	LE8-10,17-19	C	TW1 - 20	M
CB1,5,8-10,22	P	LL11-78	G	UB1 - 11	O
CB2,3,11	O	LN1-5,7-13	B	W1-14	M
CB4,6,7,21,23-25	A	LS1-13,15,18-20,26-28	B	W1B-D,F-K,M,S-U,W	O
CF10 - 83	F	LS14,16,17,21-25,29	H	WA1-14,16	E
CH1-6,9-66	E	LU1-7	O	WA15	B
CH7,8	G	M1-24,31-37,40,43,50,60,90	B	WC1	O
CM0-15,17, 25-77	P	M25-30,38,41,44-46	E	WD1	O
CM16,18,20-24	O	ME1-20	J	WF1	B
CO1-16	P	MK1-46	O	WN1	E
CRO-9	J	NI - 22	O	WR1-6,8,9,13-15	F
CT1-21	J	NE1 - 71	D	WR7,10-12	C
CV1 - 47	C	NG1 - 34	B	WS1,2,5,10	C
CV9,13	B	NN1 - 29	C	WS3,4,6-9,11-15	B
CW1-10	L	NP7 - 44	F	WV1-4,11-13 C	O
CW4,11,12	B	NR1 - 35	A	WV5-10,14-16 F	F
DA1-18	J	NW1 - 11	O	YO1 - 62 H	H
DE175	B	OL1 - 16	B		
DH1-9	D	OX1-4,9,33,39,44,49	O		
DL1,2,5,12-17	D	OX5,7,15-20, 25-29	C		
DL6-11	H	OX10-14	M		
DNI-12,14,17,21,22	B	PE1 - 38	A		
DN15,16,18-20,23,41	A	PL1 - 35	L		
DT1-5,10,11	M	PO1-12,17-22	N		
DT6-9	L	PO30-41*	N		
DY1 - 10	C	PR1 - 26	E		
DY11 - 14	F	RG1 - 45	M		
E1-19	P	RH1 - 20	N		
E20	O	RM1 - 20	P		
EC1	O	S1 - 81	B		
EC2-4	P	SA1 - 73	F		
EN1-10	P	SE1 - 28	J		
EX1-39	L	SG1 - 19	O		
FY1-8	E	SK1 - 23	B		
GL1 - 56	C	SLO - 9	M		
GL14 - 19	F	SM1 - 7	N		
GU1-47	N	SN1,11,25,26	M		
GY1-9*	M	SN12,13	L		
HAO-9	O	SN14-16	C		
HDI-9	B	SO14 - 53	M		
HG1-5	H				

*Off Shore destinations - delivery to agreed mainland port.

Scotland

Postcode Prefix	Zone
AB10-56	Grampian
DG1-16	Dumfries
DD1-11	Tayside
EH1-2, 4, 6-29, 31-42, 47-48, 50, 52-55	Lothian
EH3,5,30,49,51	Central
EH43-46	Borders
FK1-21	Central
TD1-15	Borders
G1-84	Strathclyde
IV1-63	Highlands
KA1-30	Strathclyde
KY1-16	Fife
KW1-17	Highlands
ZE1-3	Highlands
ML1-12	Strathclyde
HS1-9	Highlands
PA1-78	Strathclyde
PH1-50	Perthshire

For the latest product information
and merchant support
www.arielplastics.com

Speedwell Industrial Estate
Staveley
Derbyshire
S43 3JP

Tel: 01246 281111
Fax: 01246 561111
Email: info@arielplastics.com

Blairlinn Road
Cumbernauld
Glasgow
G67 2TF

Tel: 01236 725536
Fax: 01236 725871
Email: scotland@arielplastics.com



Q09125

Orderline email:
sales@arielplastics.com

Ariel Plastics Customer Services:
APCustomerservices@arielplastics.com



Call us:
01246 281111

Press #1
for Sales



Press #2
for our
Cut to Size
Ninja Experts

All reasonable care has been taken in the compilation of the information contained within this price list. Ariel Plastics reserves the right to amend specifications and prices without prior notice.

All recommendations on the use of our products are made without guarantee as conditions of use are beyond the control of Ariel Plastics. It is the customer's responsibility to ensure that the product is fit for its intended purpose and that the actual conditions of use are suitable.